



Maintenance and Service Guide

Compaq Notebook Evo N150 Series

Document Part Number: 238849-001

June 2001

This guide is a troubleshooting reference used for maintaining and servicing the notebook. It provides comprehensive information on identifying computer features, components, and spare parts, troubleshooting computer problems, and performing computer disassembly procedures.

© 2001 Compaq Computer Corporation

Compaq, the Compaq logo, Armada, and Deskpro Registered in U. S. Patent and Trademark Office. Evo is a trademark of Compaq Information Technologies Group, L.P. in the U.S. and other countries.

Microsoft, MS-DOS, Windows, and Windows NT are trademarks of Microsoft Corporation in the United States and other countries.

Intel, Pentium, and Celeron are trademarks of Intel Corporation in the United States and other countries.

All other product names mentioned herein may be trademarks of their respective companies.

Compaq shall not be liable for technical or editorial errors or omissions contained herein. The information in this document is provided “as is” without warranty of any kind and is subject to change without notice. The warranties for Compaq products are set forth in the express limited warranty statements accompanying such products. Nothing herein should be construed as constituting an additional warranty.

Maintenance and Service Guide

First Edition (June 2001)

Document Part Number: 238849-001

Contents

1 Product Description

1.1 Models and Features	1-1
Models	1-2
Features	1-5
1.2 Clearing a Password	1-6
1.3 Power Management	1-7
1.3 External Computer Components	1-8
1.4 Design Overview	1-18

2 Troubleshooting

Using the PhoenixBIOS Setup Utility	2-2
Troubleshooting Flowcharts.	2-3
2.1 Initial Troubleshooting	2-4
2.2 No Power, Part 1	2-5
2.3 No Power, Part 2	2-6
2.4 No Power, Part 3	2-7
2.5 No Power, Part 4	2-8
2.6 No Video, Part 1	2-9
2.7 No Video, Part 2	2-10
2.8 Non Functioning Docking Station (if applicable).	2-11
2.9 No Operating System (OS) Loading	2-12
2.10 No OS Loading from Hard Drive, Part 1.	2-13
2.11 No OS Loading from Hard Drive, Part 2.	2-14
2.12 No OS Loading from Hard Drive, Part 3.	2-15
2.13 No OS Loading from Diskette Drive.	2-16
2.14 No OS Loading from CD- or DVD-ROM Drive	2-17

2.15 No Audio, Part 1	2-18
2.16 No Audio, Part 2	2-19
2.17 Non Functioning Device	2-20
2.18 Non Functioning Keyboard	2-21
2.19 Non Functioning Pointing Device	2-22
2.20 Network or Modem Connection	2-23

3 Illustrated Parts Catalog

3.1 Serial Number Location	3-1
3.2 Computer System Major Components	3-2
3.3 Miscellaneous Plastics Kit Components	3-8
3.4 Miscellaneous Hardware Kit Components	3-9
3.5 Cable Kit Components	3-10
3.6 Mass Storage Devices	3-11
3.7 Miscellaneous	3-12

4 Removal and Replacement Preliminaries

4.1 Tools Required	4-1
4.2 Service Considerations	4-1
Plastic Parts	4-2
Cables and Connectors	4-2
4.3 Preventing Damage to Removable Drives	4-2
4.4 Preventing Electrostatic Damage	4-4
4.5 Packaging and Transporting Precautions	4-4
4.6 Workstation Precautions	4-5
4.7 Grounding Equipment and Methods	4-6

5 Removal and Replacement Procedures

5.1 Serial Number	5-2
5.2 Disassembly Sequence Chart	5-3
5.3 Preparing the Computer for Disassembly	5-4
5.4 Computer Feet	5-4
5.5 Hinge Covers	5-5
5.6 Keyboard	5-6
5.7 Display	5-8

5.8 EMI Shield	5-10
5.9 Top Cover	5-11
5.10 TouchPad	5-15
5.11 Speakers	5-18
5.12 Microphone	5-21
5.13 Display Lid Switch Board	5-23
5.14 Heat Sink	5-24
5.15 Infrared Board	5-26
5.16 System Board	5-28
5.17 PC Card Assembly	5-33
5.18 Mini PCI Board	5-35
5.19 Disk Cell RTC Battery	5-37

6 Specifications

A Connector Pin Assignments

B Power Cord Set Requirements

3-Conductor Power Cord Set	B-1
General Requirements	B-1
Country-Specific Requirements	B-2
Notes	B-2

C Screw Listing

Index

Product Description

1.1 Models and Features

The Compaq Notebook Evo N150 Series offer advanced modularity, Intel Pentium III and Intel Celeron processors with 64-bit architecture, industry-leading Accelerated Graphics Port (AGP) implementation, and extensive multimedia support.



Figure 1-1. Compaq Notebook Evo N150

Models

Computer models are shown in Table 1-1.

**Table 1-1
Compaq Notebook Evo N150
Models and Model Naming Conventions**

Key										
N15	P	800	T4X	15	V	C	64	8L	ME	XXXXXXXX-XXX
1	2	3	4	5	6	7	8	9	10	11
Key	Description				Options					
1	Brand / Series designator				N=Notebook			15=150		
2	Processor type				P=Intel Pentium III			C=Intel Celeron		
3	Processor speed				800=800 MHz			700=700MHz		
4	Display type / size / resolution				T=TFT 4=14.x-inch			X=XGA (1024 x 768)		
5	Hard drive size				15=15.0 GB			10=10.0 GB		
6	Optical drive designator				V=8X Max DVD-ROM drive			D=24X Max CD-ROM drive W=CD-RW		
7	Integrated communication				M=modem 0=none			C=modem/NIC combination card		
8	RAM				64=64 MB					
9	Battery cells / type				8L=8 cells, Lithium ion (Li ion)			9H=9 cells, Nickel Metal-Hydride (NMH)		
10	Operating system				ME=Windows Millennium Edition					
11	SKU#				All computer models use 470013-XXX as the base SKU#.					

All computer models use configuration code **JQKZ**.

Table 1-1
Compaq Notebook Evo N150
Models and Model Naming Conventions (Continued)

1	2	3	4	5	6	7	8	9	10	11
N15	P	800	T4X	15	V	C	64	8L	ME	470013-XXX
Belgium				470013-663			Norway			470013-668
Czech Republic				470013-735			Portugal			470013-748
Denmark				470013-664			Russia			470013-749
France				470013-737			Saudi Arabia			470013-734
French Canada				470013-662			Slovakia / Slovenia			470013-669
Germany				470013-739			Spain			470013-751
Greece / Poland				470013-665			Sweden / Finland			470013-670
Hungary				470013-741			Switzerland			470013-671 470013-672
Israel				470013-743			Turkey			470013-753
Italy				470013-745			United Kingdom			470013-754
Korea				470013-674			United States			470013-661 470013-726
The Netherlands				470013-747						
N15	P	800	T4X	15	V	0	64	8L	ME	470013-XXX
Europe										470013-728
N15	P	800	T4X	10	V	C	64	8L	ME	470013-XXX
Australia				470013-673 470013-727			Taiwan			470013-675
Japan				470013-691 470013-693						

Table 1-1
Compaq Notebook Evo N150
Models and Model Naming Conventions (Continued)

1	2	3	4	5	6	7	8	9	10	11
N15	C	700	T4X	15	D	C	64	8L	ME	470013-XXX
Taiwan										470013-659
N15	C	700	T4X	10	D	C	64	8L	ME	470013-XXX
Asia / Pacific				470013-658			The Netherlands			470013-713
Australia				470013-731			Norway			470013-621
Belgium				470013-619			Portugal			470013-714
Czech Republic				470013-701			Russia			470013-718
Denmark				470013-620			Slovakia / Slovenia			470013-622
France				470013-702			Spain			470013-719
Germany				470013-703			Sweden / Finland			470013-623
Hungary				470013-705			Switzerland			470013-624 470013-625
Israel				470013-709			Turkey			470013-722
Italy				470013-712			United Kingdom			470013-723
Japan				470013-684 470013-685			United States			470013-617 470013-660 470013-730
N15	C	700	T4X	10	W	C	64	8L	ME	470013-XXX
Japan				470013-687			Taiwan			470013-688
N15	C	700	T4X	10	D	C	64	9H	ME	470013-XXX
French Canada				470013-618			Saudi Arabia			470013-700
N15	C	700	T4X	10	D	0	64	9H	ME	470013-XXX
European										470013-724

Features

- Processors, varying by computer model:
 - ❑ 800-MHz Intel Pentium III Processor with 256-KB integrated cache
 - ❑ 700-MHz Intel Celeron Processor with 128-KB integrated cache
- 64-MB high-performance Synchronous DRAM (SDRAM), expandable to 512 MB
- Integrated Trident CyberBlade i1 with AGP 2X support
- 14.1-inch, XVGA, TFT (1024 × 768) display, with over 16.8 million colors
- 15- or 10-GB high-capacity hard drive
- Full-size TouchPad keyboard
- Mini PCI 56K V.90 modem or optional Mini PCI V.90 modem plus 10/100 NIC combination card
- Support for two Type II PC Card slots with support for both 32-bit CardBus and 16-bit PC Cards
- Microsoft Windows Me, Windows 98, or Windows 2000 preinstalled
- External AC adapter with power cord
- 8-cell Lithium ion (Li ion) battery pack

- Connectors for:
 - ❑ RJ-11 modem
 - ❑ universal serial bus
 - ❑ stereo line out/headphone
 - ❑ parallel
 - ❑ serial
 - ❑ external keyboard/mouse
 - ❑ RJ-45 network
 - ❑ external monitor
 - ❑ AC power
- Stereo speakers providing Compaq PremierSound 16-bit stereo sound

1.2 Clearing a Password

If the notebook you are servicing has an unknown password, follow these steps to clear the password. These steps also clear CMOS.

1. Prepare the computer for disassembly. Refer to Section 5.3, “Preparing the Computer for Disassembly,” for more information.
2. Remove the RTC battery. Refer to Section 5.19, “Disk Cell Real Time Clock (RTC) Battery,” for more information.
3. Wait approximately five minutes.

4. Replace the RTC battery and reassemble the computer.
5. Connect AC power to the computer. Do **not** reinsert any battery packs at this time.
6. Turn on the computer.

All passwords and all CMOS settings are clear.

1.3 Power Management

The computer comes with a collection of power management features that extend battery operating time and conserve power. The computer supports the following power management features:

- Standby
- Hibernation
- Smart battery that provides an accurate battery power gauge
- Battery calibration
- Lid switch suspend/resume
- Power button
- Advanced Configuration and Power Management (ACP) compliant

1.3 External Computer Components

The external components on the front and left side of the computer are shown in Figure 1-2 and described in Table 1-2.



Figure 1-2. Front and Left Side Components

Table 1-2
Front and Left Side Panel Components

Item	Component	Function
1	Security cable slot	Attaches an optional security cable to the computer.
2	Vent	Allows airflow to cool internal components.

△ **CAUTION:** To prevent damage, the computer will shut down if a severe overheating condition occurs. To prevent loss of information, do not block the cooling vent. Avoid placing the computer on a blanket, rug, or other flexible surface that may cover the vent area.

Table 1-2
Front and Left Side Panel Components (Continued)

Item	Component	Function
3	Air intake vent	Cools internal components.
4	RJ-11 jack (internal modem models only)	Connects the modem cable to an internal modem. A modem cable is included with internal modem models.
5	USB connector	Connects USB devices.
6	PC Card slots (2)	Support a 32-bit (CardBus) or 16-bit PC Card.
7	PC Card eject buttons	Eject a PC Card from a PC Card slot.
8	Stereo line-out/ headphone jack	Connects stereo speakers, headphones, headset, or television audio.
9	Stereo line-in jack	Connects a CD player, tuner, or tape deck.
10	Power light	On: Power is turned on. Blinking: Computer is in Standby. The power light also blinks if a battery pack that is the only available power source reaches a low-battery condition.
11	Battery light	On: A battery pack is charging. Blinking: A battery pack that is the only available power source has reached a low-battery condition.
12	Hard drive	Supports the removable primary hard drive. Two screws secure the hard drive to the computer.

The computer right side and rear panel components are shown in Figure 1-3 and described in Table 1-3.

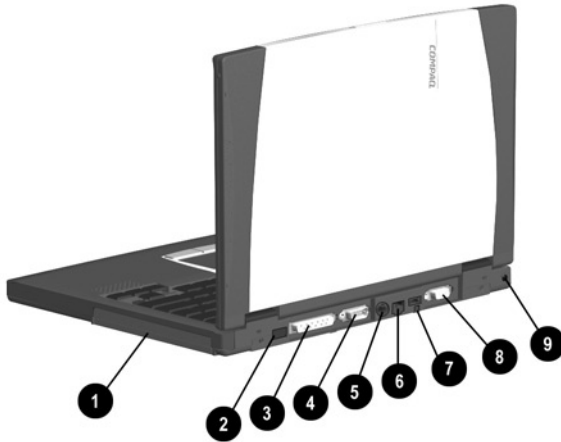



Figure 1-3. Right Side and Rear Panel Components

Table 1-3
Right Side and Rear Panel Components

Item	Component	Function
1	Media Bay	Accepts a diskette drive, CD- or DVD-ROM drive, or secondary battery pack.
2	Infrared port	Links to another IrDA-compliant device for wireless communication.

Table 1-3
Right Side and Rear Panel Components (Continued)

Item	Component	Function
3	Parallel connector	Connects a parallel device.
4	Serial connector	Connects a serial device.
5	Keyboard/mouse connector	<p>Connects an external keyboard or PS/2-compatible external mouse.</p> <p> To connect a keyboard and a mouse at the same time, use an optional Y-adapter.</p>
6	RJ-45 jack (network models only)	Connects the network cable. A network cable is not included with the computer.
7	USB connectors	Connect USB devices.
8	External monitor connector	Connects an external monitor or overhead projector.
9	DC power jack	<p>Connects any one of the following items:</p> <ul style="list-style-type: none"> ■ AC Adapter ■ Optional Automobile Power Adapter/Charger ■ Optional Aircraft Power Adapter

The keyboard components are shown in Figure 1-4 and described in Table 1-4.

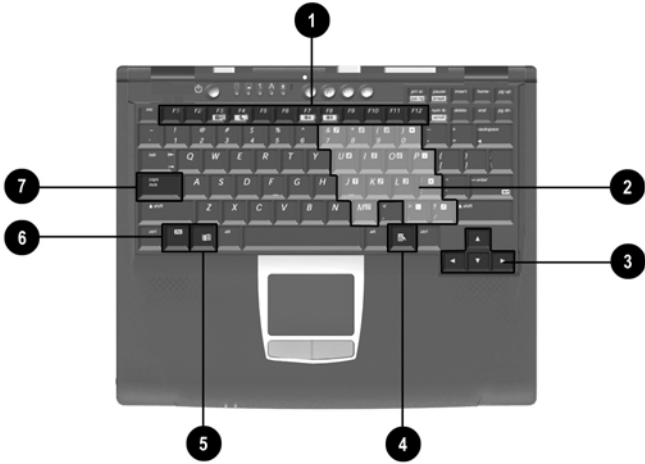

Figure 1-4. Keyboard Components

Table 1-4
Keyboard Components

Item	Component	Function
1	F1 through F12 function keys	Perform preset functions.
2	Embedded numeric keypad	Converts keys to numeric keypad.
3	Cursor control keys	Move the cursor around the screen.
4	Windows application key	Displays a menu when using a Microsoft application. The menu is the same that is displayed by pressing the right mouse button.
5	Windows logo key	Displays the Windows Start menu.
6	Fn key	Used with hotkeys to perform preset hotkey functions.
7	Caps lock key	Turns on the caps lock function.

The components on the top of the computer are shown in Figure 1-5 and described in Table 1-5.

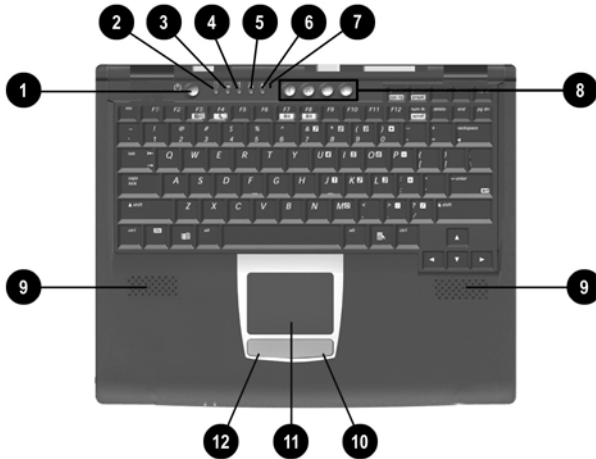

Figure 1-5. Top Components

**Table 1-5
Top Components**

Item	Component	Function
1	Power button	Turns on the computer. To turn off the computer, use the operating system Shut Down command.
2	Drive light indicator	Turns on when the hard drive, CD-, or DVD-ROM drive is accessed.

Table 1-5
Top Components (*Continued*)

Item	Component	Function
3	Diskette drive light	Turns on when the diskette drive in the Media Bay or the optional external diskette drive is accessed.
4	Num lock light	On: Num lock is on and the embedded numeric keypad is enabled.
5	Caps lock light	On: Caps lock is on.
6	Scroll lock light	On: Scroll is on.
7	Microphone	Inputs single-channel sound to the computer; can be used whether the computer is open or closed.
8	Easy Access buttons (4)	Four buttons that provide quick access to the Internet. Refer to the <i>Hardware Guide</i> that ships with the computer for information about these buttons.
9	Stereo speakers (2)	Produce stereo sound.
10	Right TouchPad button	Functions like the right mouse button on an external mouse.
11	TouchPad	Moves the mouse cursor, selects, and activates.
12	Left TouchPad button	Functions like the left mouse button on an external mouse.

The external components on the bottom of the computer are shown in Figure 1-6 and described in Table 1-6.

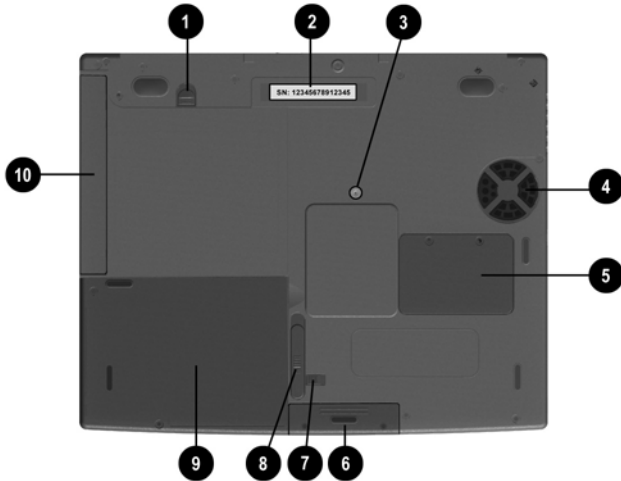



Figure 1-6. Bottom Components

**Table 1-6
Bottom Components**

Component	Function	
1	Media Bay release latch	Releases the Media Bay device from the connector.
2	Serial number	Identifies the computer; needed when you call Compaq customer support.

Table 1-6
Bottom Components (Continued)

	Component	Function
3	Reset button	Manually resets the system if a failure occurs.  WARNING: Resetting the computer will cause unsaved information to be lost. Before performing a reset, close all applications and shut down Windows, if possible.
4	Fan	Provides airflow to cool internal components.
5	Memory expansion compartment cover	Covers the memory expansion compartment that contains two memory expansion slots for memory expansion boards.
6	Hard drive	Removable primary hard drive. Two screws secure the hard drive to the computer.
7	Battery security latch	Secures the battery pack in the battery compartment.
8	Battery release latch	Releases the battery pack from the battery compartment.
9	Battery compartment	Holds the primary battery pack.
10	Media Bay	Accepts a diskette drive, CD- or DVD-ROM drive, or secondary battery pack.

1.4 Design Overview

This section presents a design overview of key parts and features of the computer. Refer to Chapter 3, “Illustrated Parts Catalog,” to identify replacement parts, and Chapter 5, “Removal and Replacement Procedures,” for disassembly steps. The system board provides the following device connections:

- Memory expansion board
- Hard drive
- Display
- Keyboard/TouchPad or pointing stick
- Audio
- Intel Pentium III or Celeron processors
- Fan
- PC Card
- Modem or modem/NIC

The computer uses an electrical fan for ventilation. The fan is controlled by a temperature sensor and is designed to turn on automatically when high temperature conditions exist. These conditions are affected by high external temperatures, system power consumption, power management/battery conservation configurations, battery fast charging, and software applications. Exhaust air is displaced through the ventilation grill located on the right side of the computer.



CAUTION: To properly ventilate the computer, allow at least a 3-inch (7.6-cm) clearance on the left and right sides of the computer.

Troubleshooting



WARNING: Only authorized technicians trained by Compaq should repair this equipment. All troubleshooting and repair procedures are detailed to allow only subassembly/module level repair. Because of the complexity of the individual boards and subassemblies, no one should attempt to make repairs at the component level or to make modifications to any printed wiring board. Improper repairs can create a safety hazard. Any indication of component replacement or printed wiring board modification may void any warranty or exchange allowances.

Utilities that are preinstalled on the computer include:

- **PhoenixBIOS Setup Utility**—Allows you to modify or restore factory default settings and configure the system BIOS to diagnose and solve minor problems.
- **Power Management**—Allows you to reduce your computer power consumption. Power Management information is contained in Chapter 1.
- **Security**—Allows you to set or remove your power-on password.

Using the PhoenixBIOS Setup Utility

The PhoenixBIOS Setup Utility (PSU) is built into the system. You can configure the system BIOS and modify or restore factory default settings, such as date and time, types of disk drives, power management, and password settings. To run PSU, press **F10** during system startup. When the main screen displays, use the keyboard and arrow keys to move around the menus and make selections.

Troubleshooting Flowcharts

Table 2-1
Troubleshooting Flowcharts Overview

Section	Description
2.1	Initial troubleshooting
2.2	No power, part 1
2.3	No power, part 2
2.4	No power, part 3
2.5	No power, part 4
2.6	No video, part 1
2.7	No video, part 2
2.8	Non functioning docking station
2.9	No operating system (OS) loading
2.10	No OS loading from hard drive, part 1
2.11	No OS loading from hard drive, part 2
2.12	No OS loading from hard drive, part 3
2.13	No OS loading from diskette drive
2.14	No OS loading from CD- or DVD-ROM drive
2.15	No audio, part 1
2.16	No audio, part 2
2.17	Non functioning device
2.18	Non functioning keyboard
2.19	Non functioning pointing device
2.20	No network or modem connection

2.1 Initial Troubleshooting

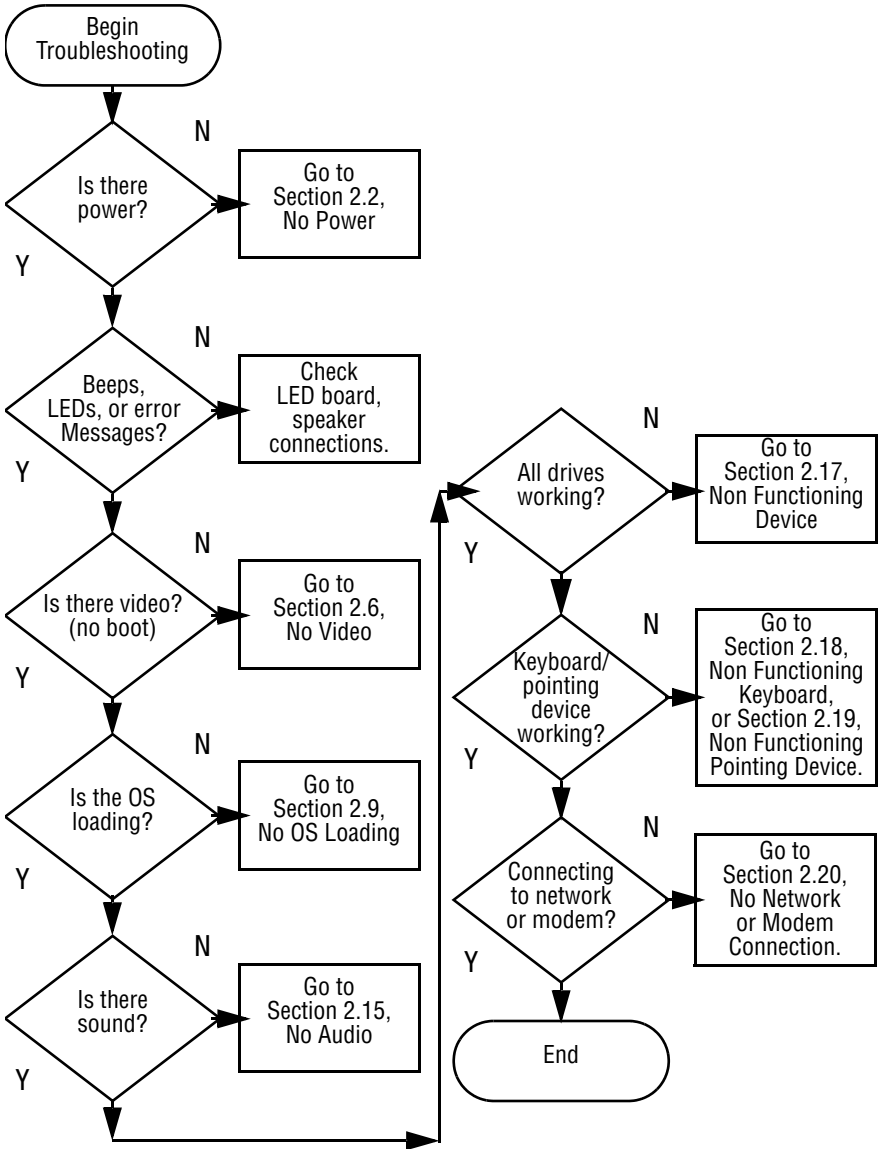

2.2 No Power, Part 1

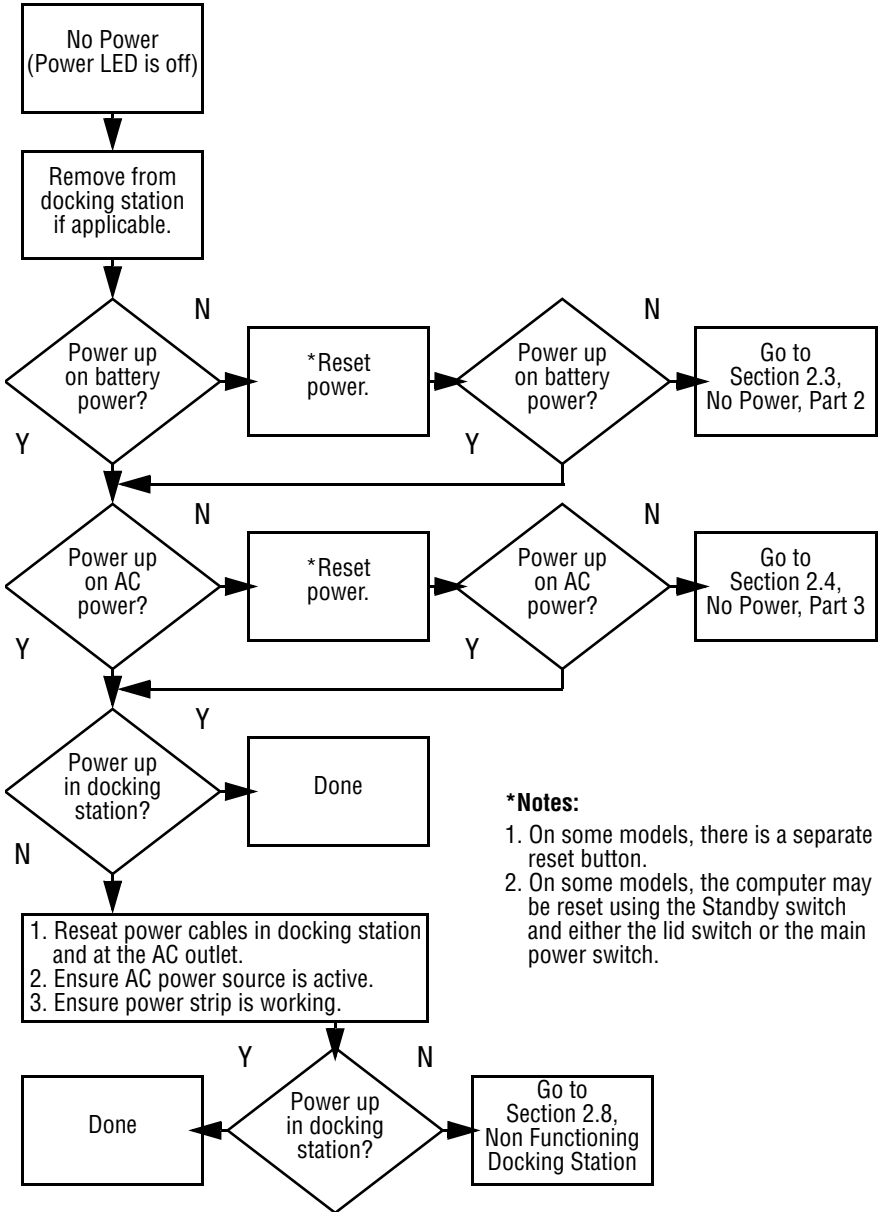

***Notes:**

1. On some models, there is a separate reset button.
2. On some models, the computer may be reset using the Standby switch and either the lid switch or the main power switch.

2.3 No Power, Part 2

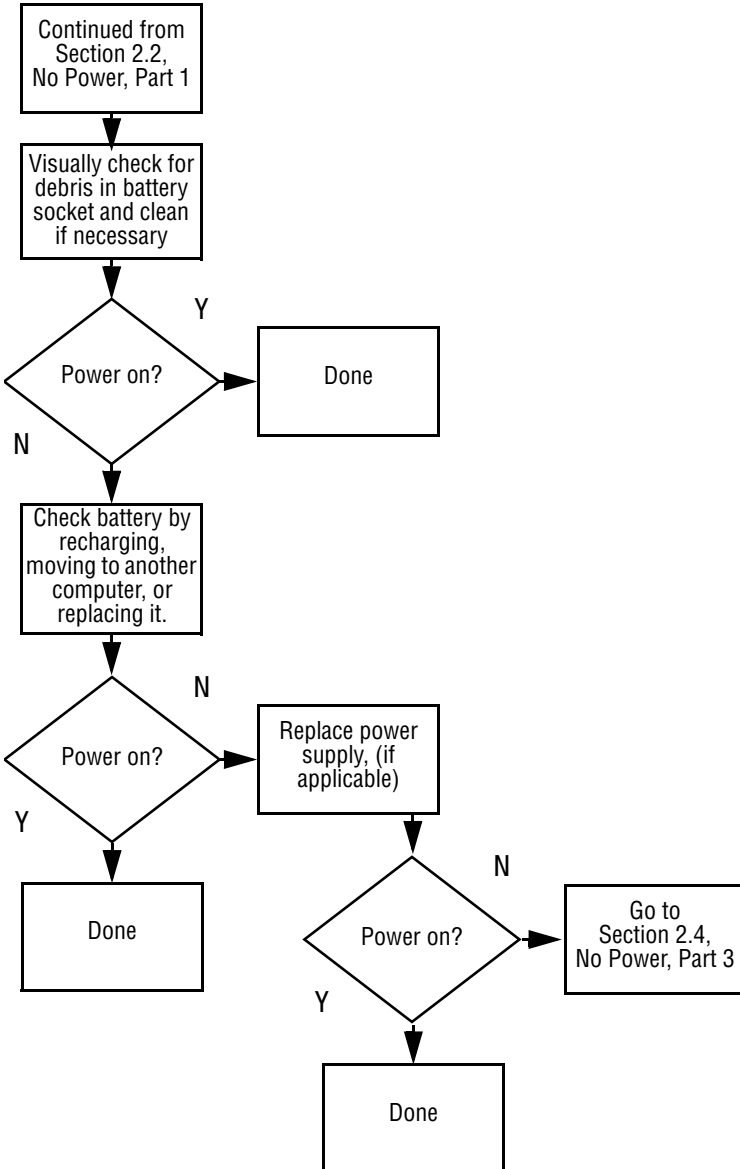

2.4 No Power, Part 3

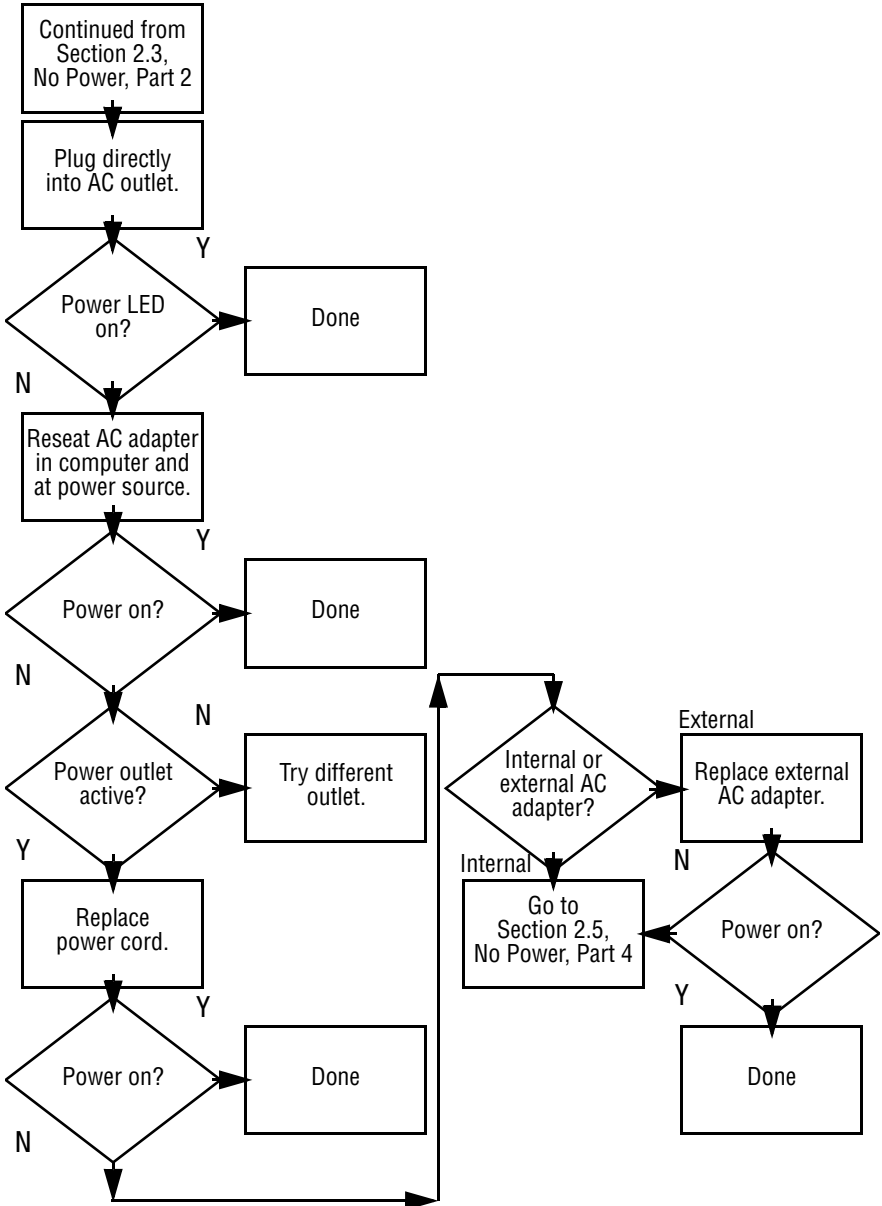

2.5 No Power, Part 4

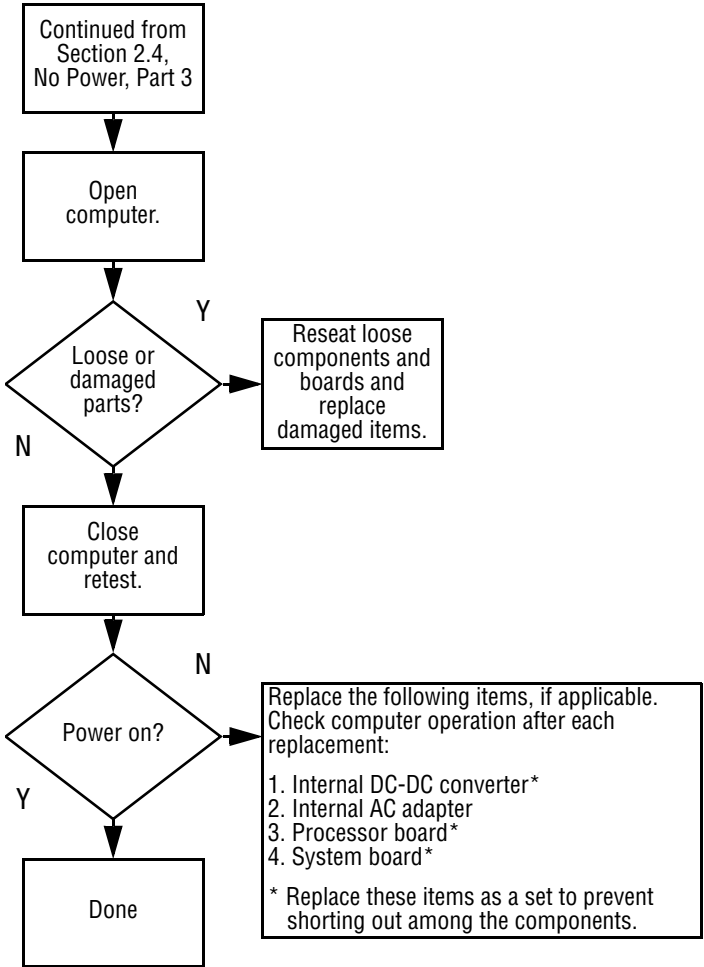

2.6 No Video, Part 1

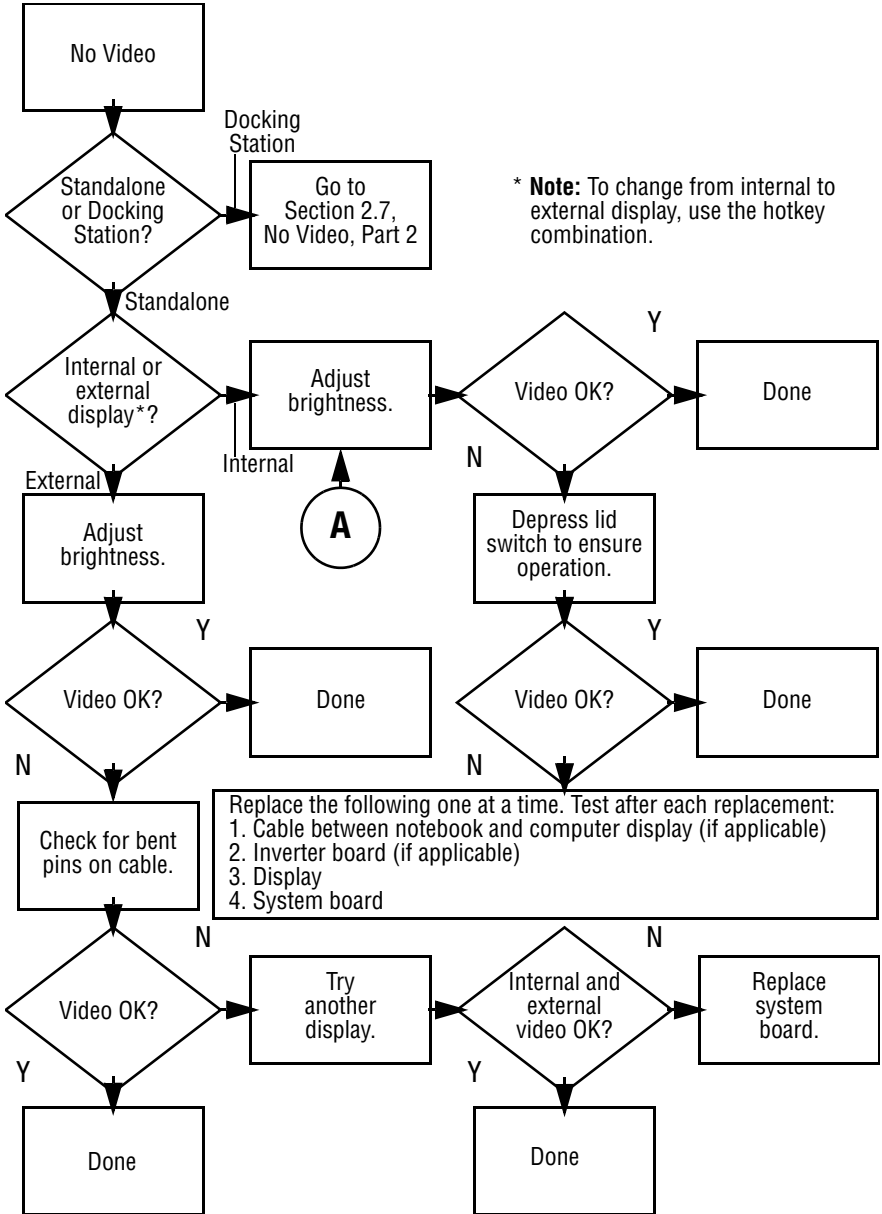

2.7 No Video, Part 2

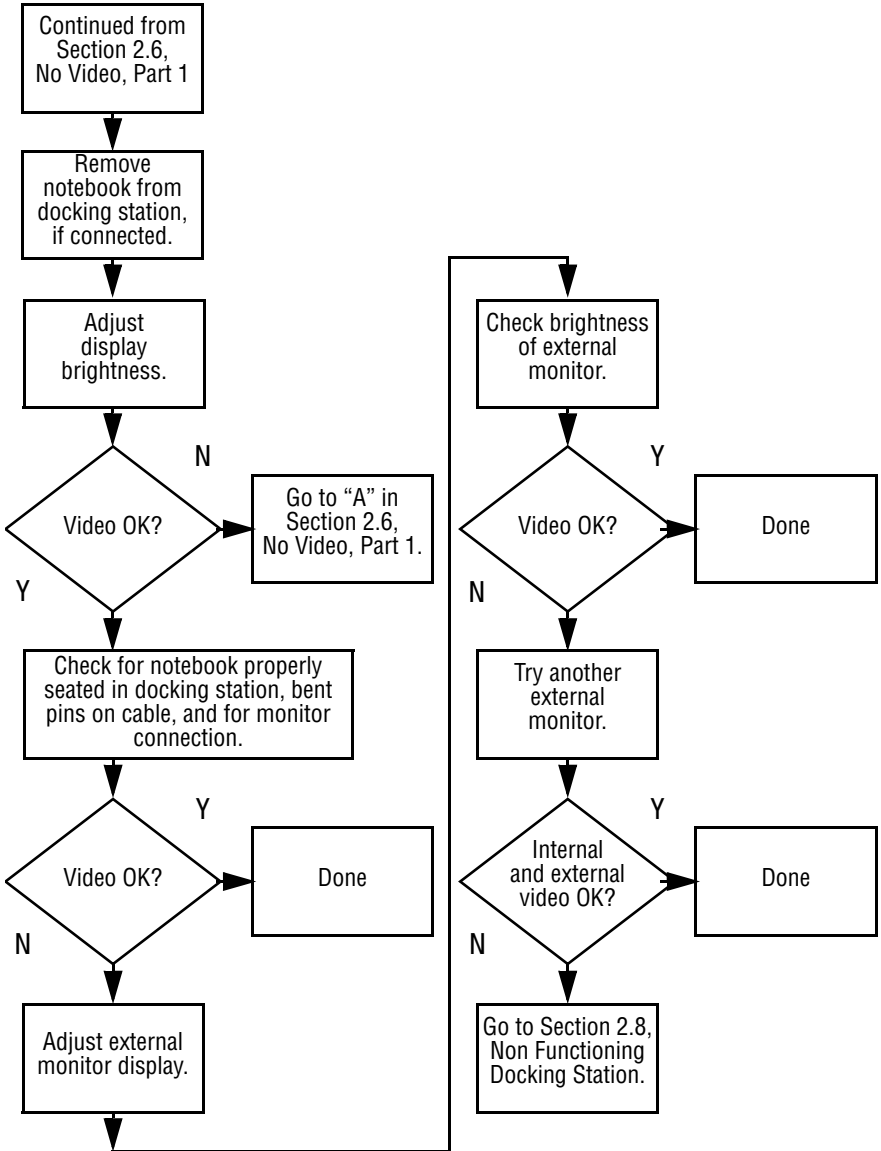

2.8 Non Functioning Docking Station (if applicable)

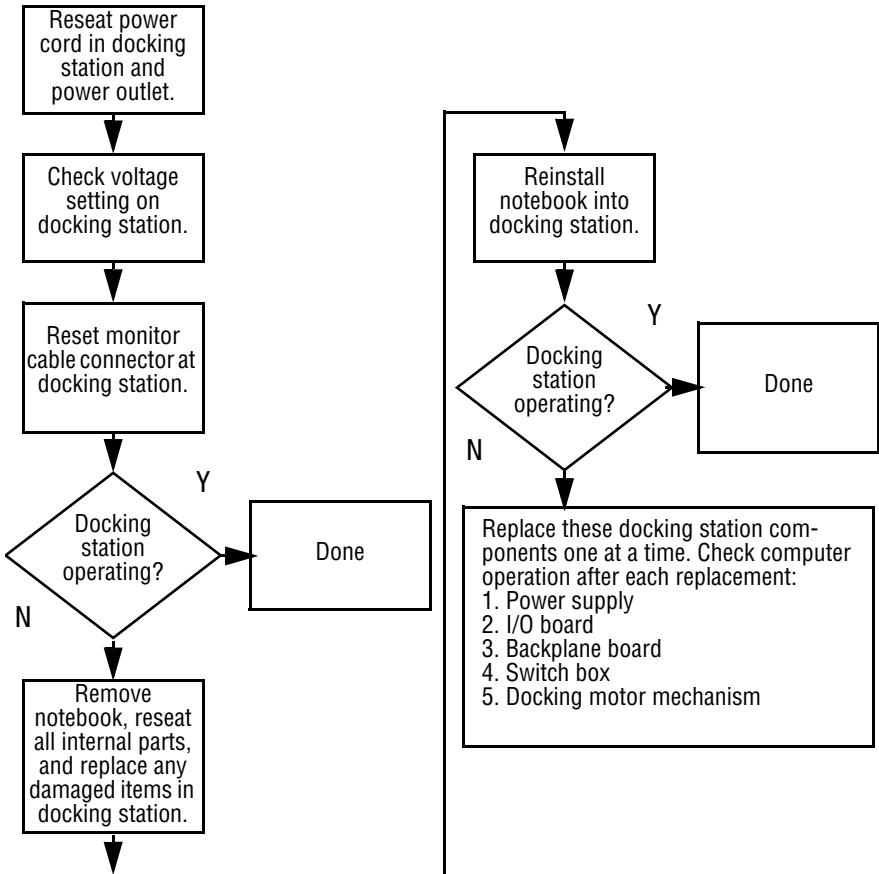

2.9 No Operating System (OS) Loading

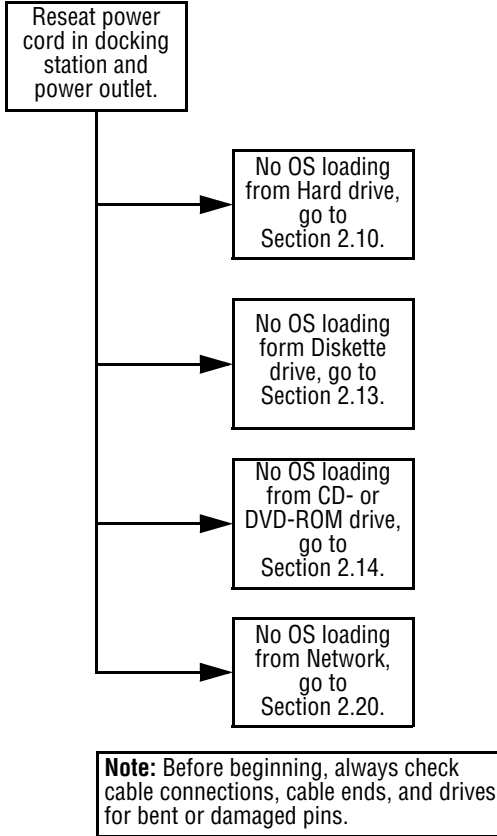

2.10 No OS Loading from Hard Drive, Part 1

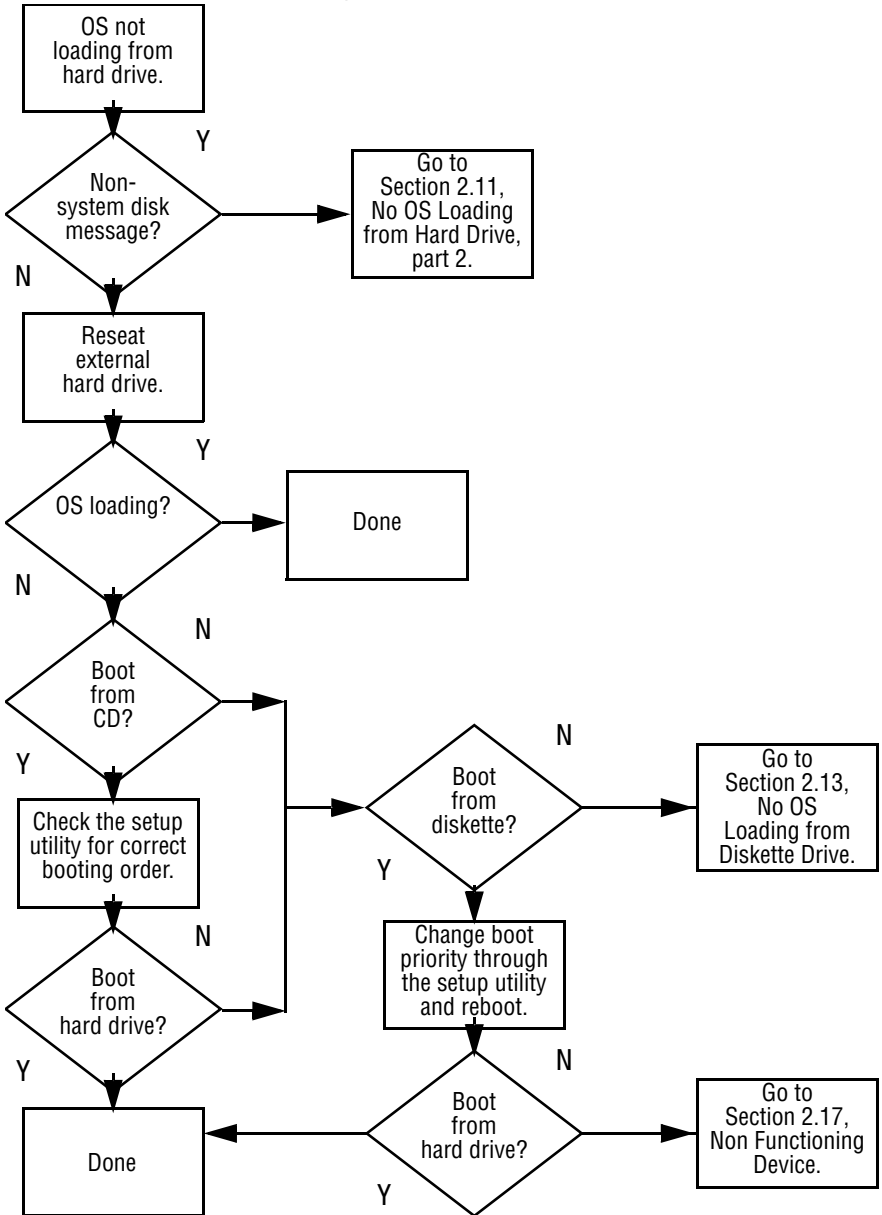

2.12 No OS Loading from Hard Drive, Part 3

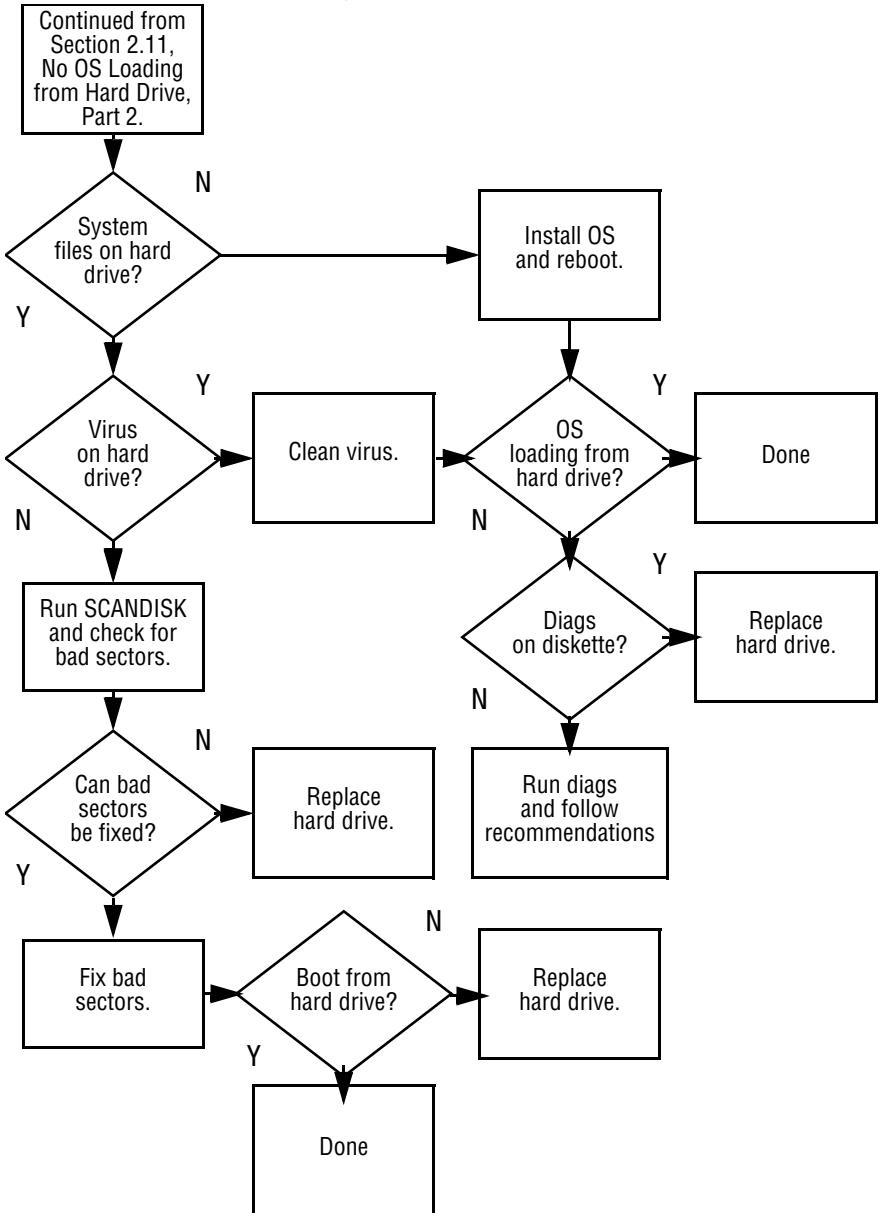

2.13 No OS Loading from Diskette Drive

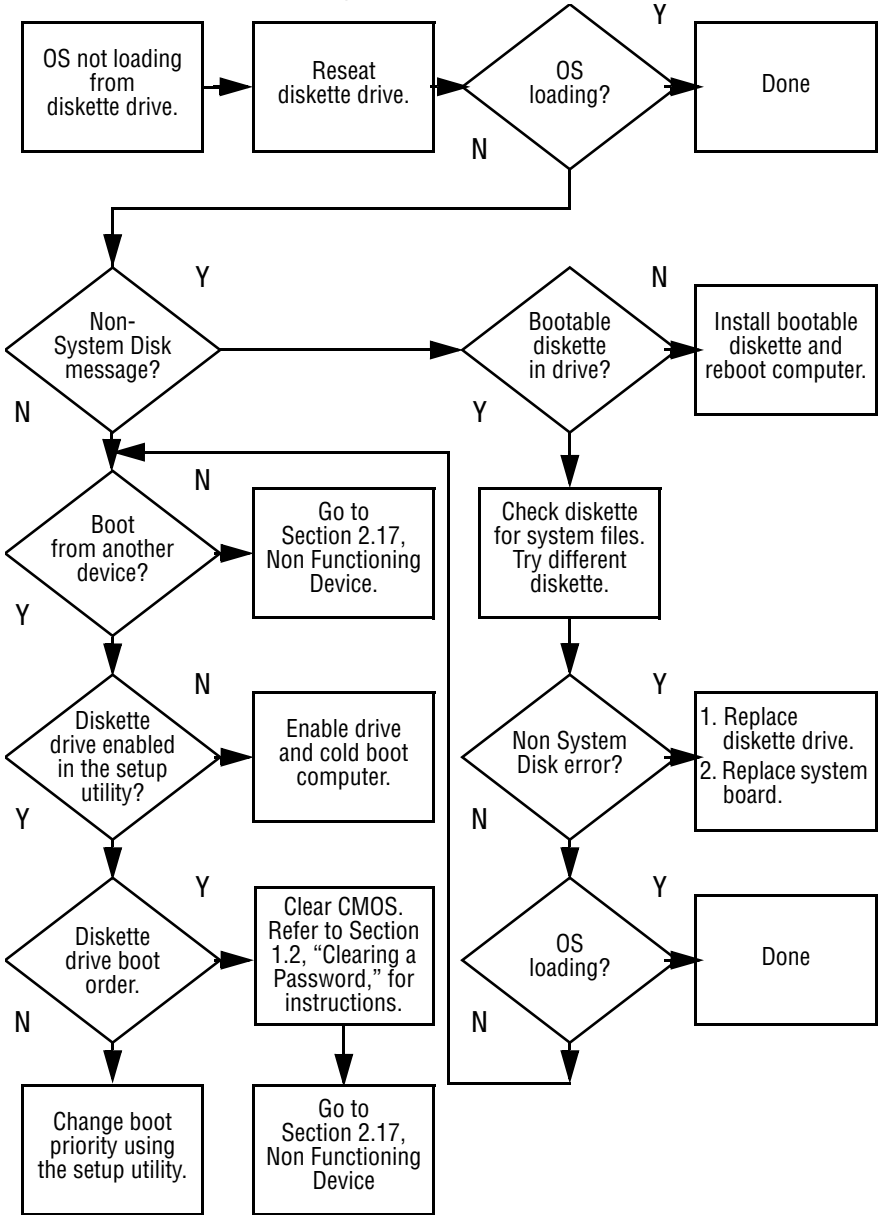

2.14 No OS Loading from CD- or DVD-ROM Drive

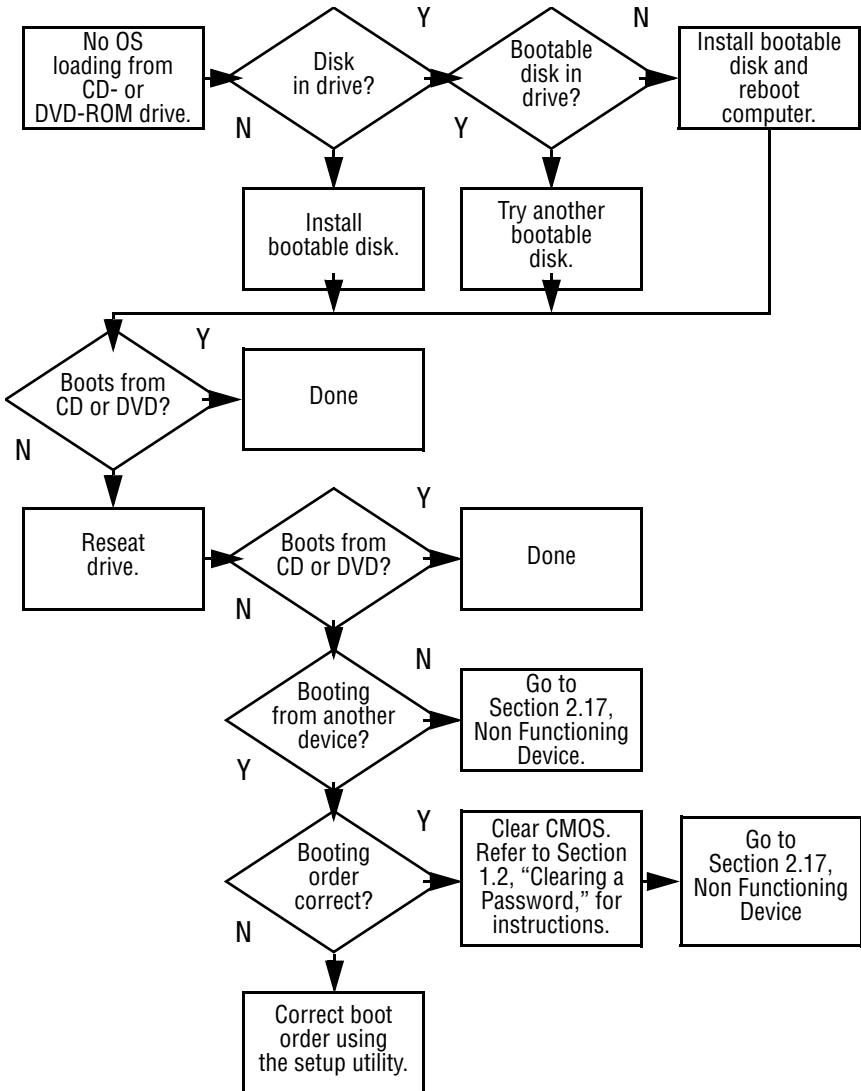

2.15 No Audio, Part 1

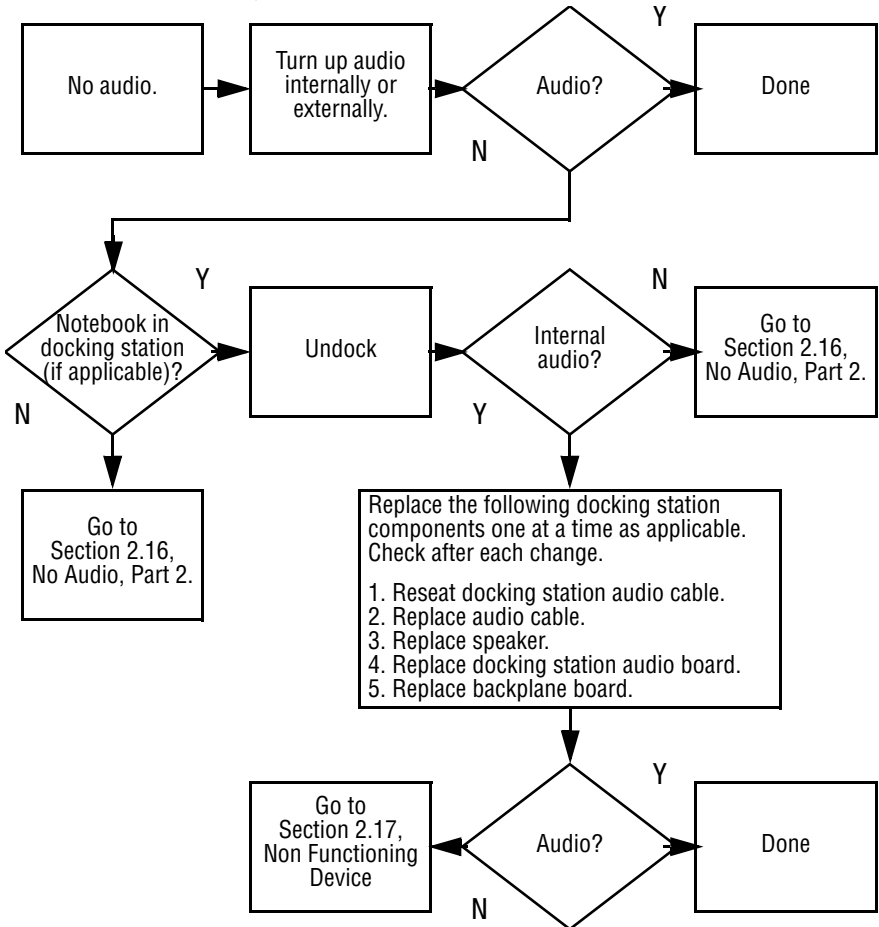

2.16 No Audio, Part 2

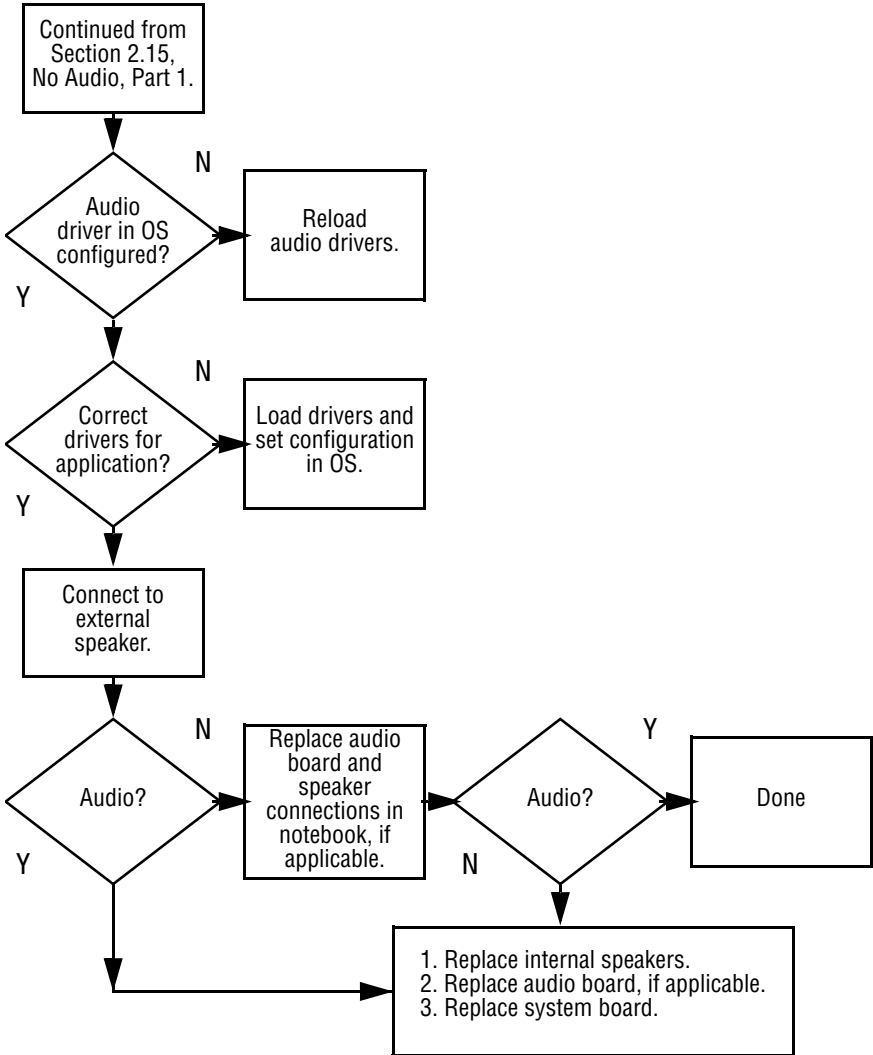

2.17 Non Functioning Device

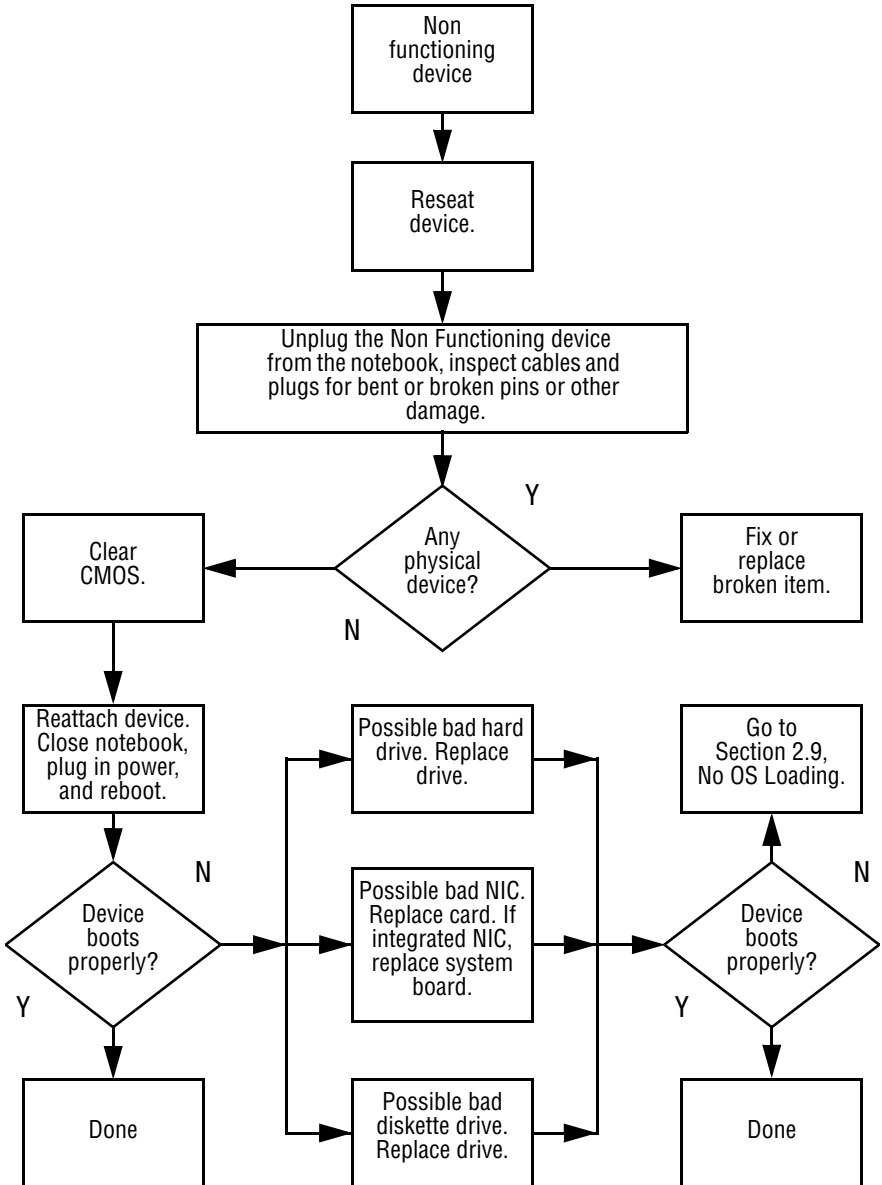

2.18 Non Functioning Keyboard

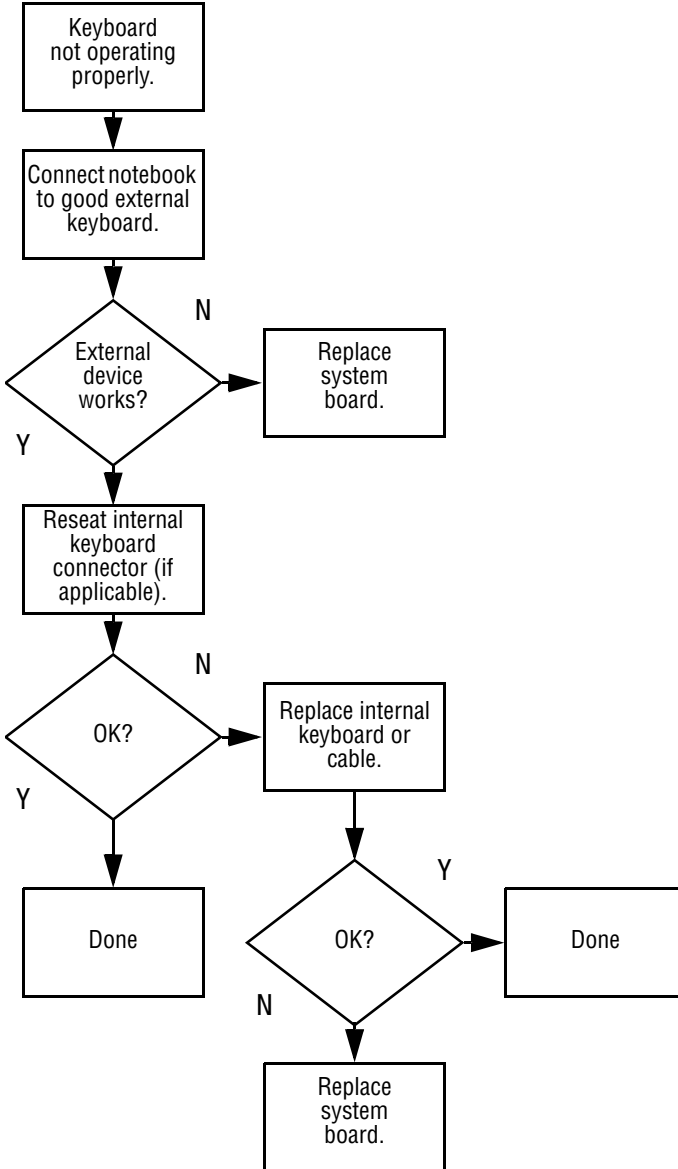

2.19 Non Functioning Pointing Device

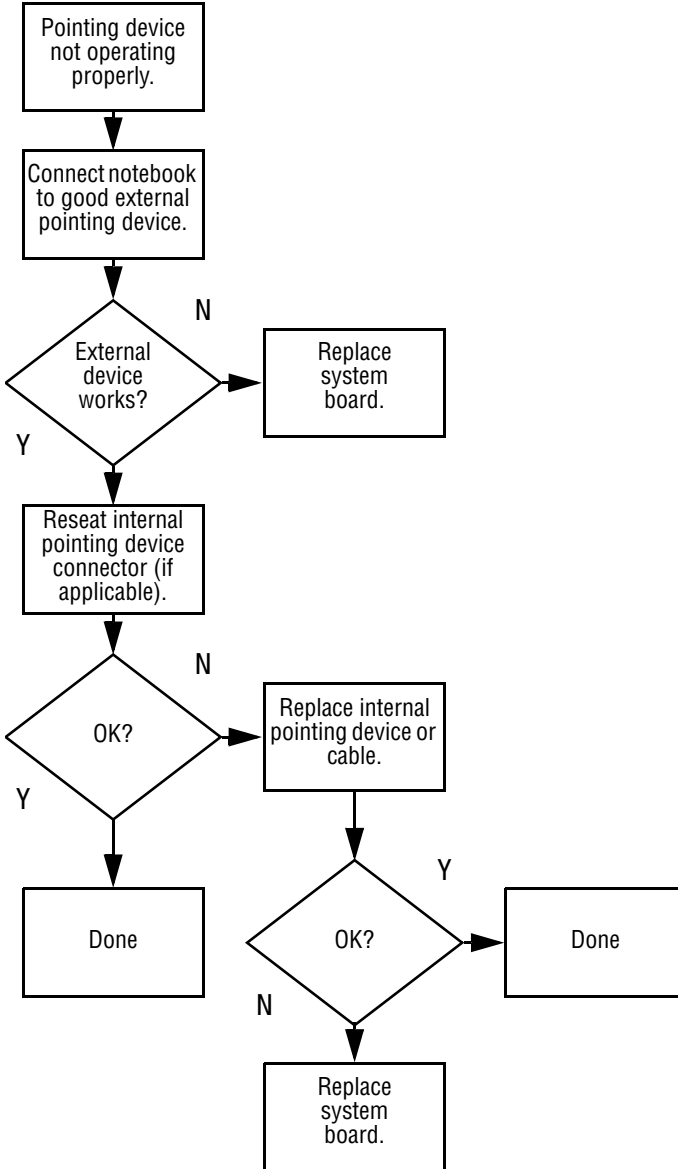

2.20 Network or Modem Connection

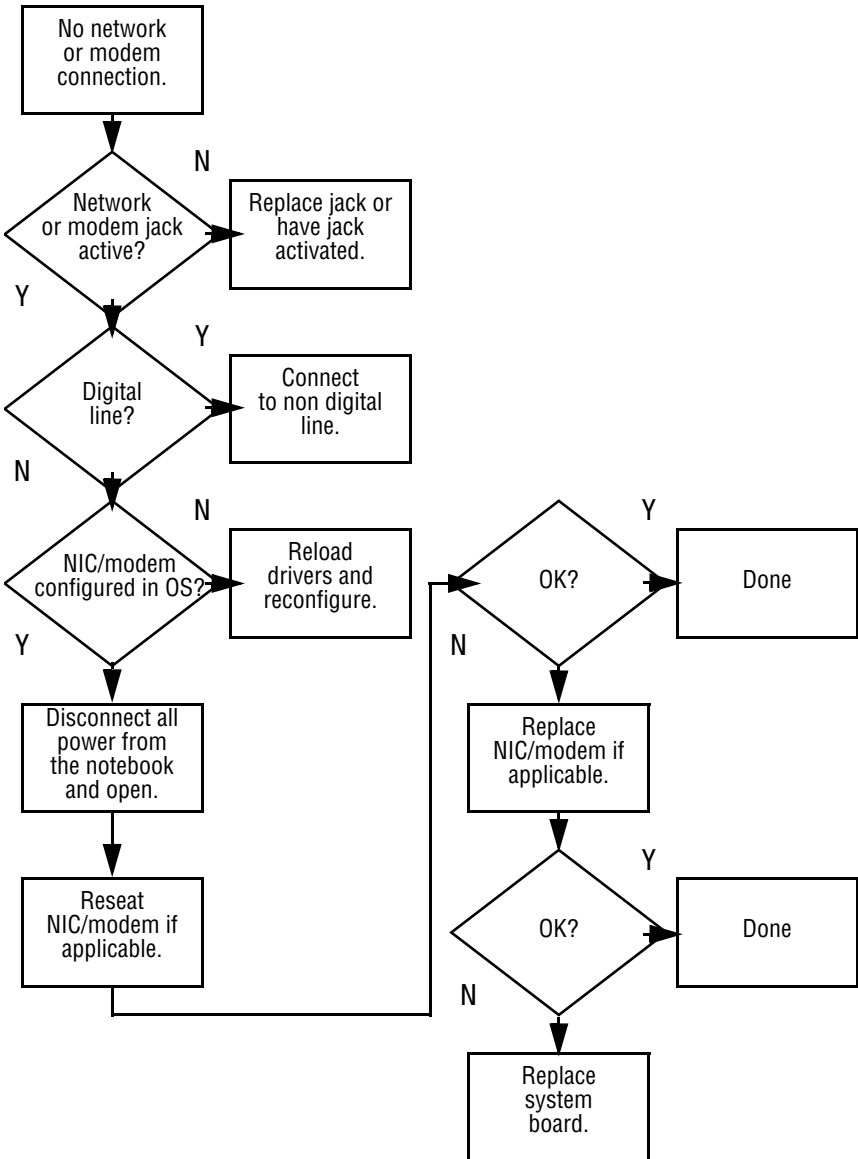

Illustrated Parts Catalog

This chapter provides an illustrated parts breakdown and a reference for spare part numbers.

3.1 Serial Number Location

When ordering parts or requesting information, provide the computer serial number and model number located on the bottom of the computer (Figure 3-1).



Figure 3-1. Serial Number Location

3.2 Computer System Major Components

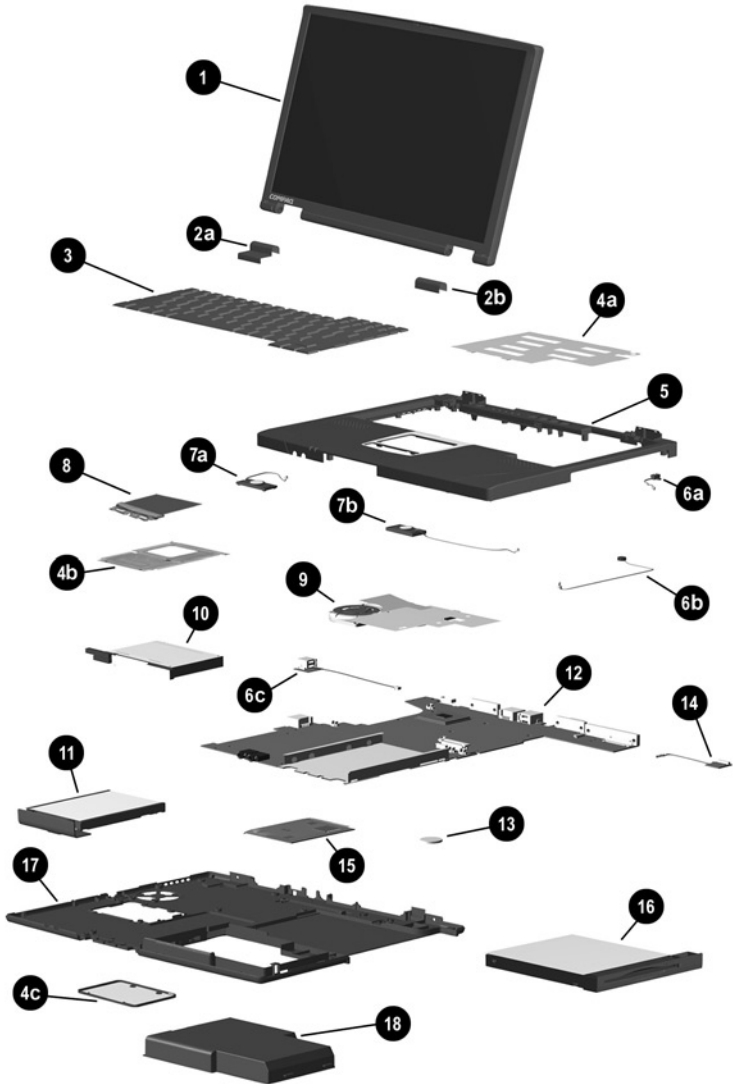
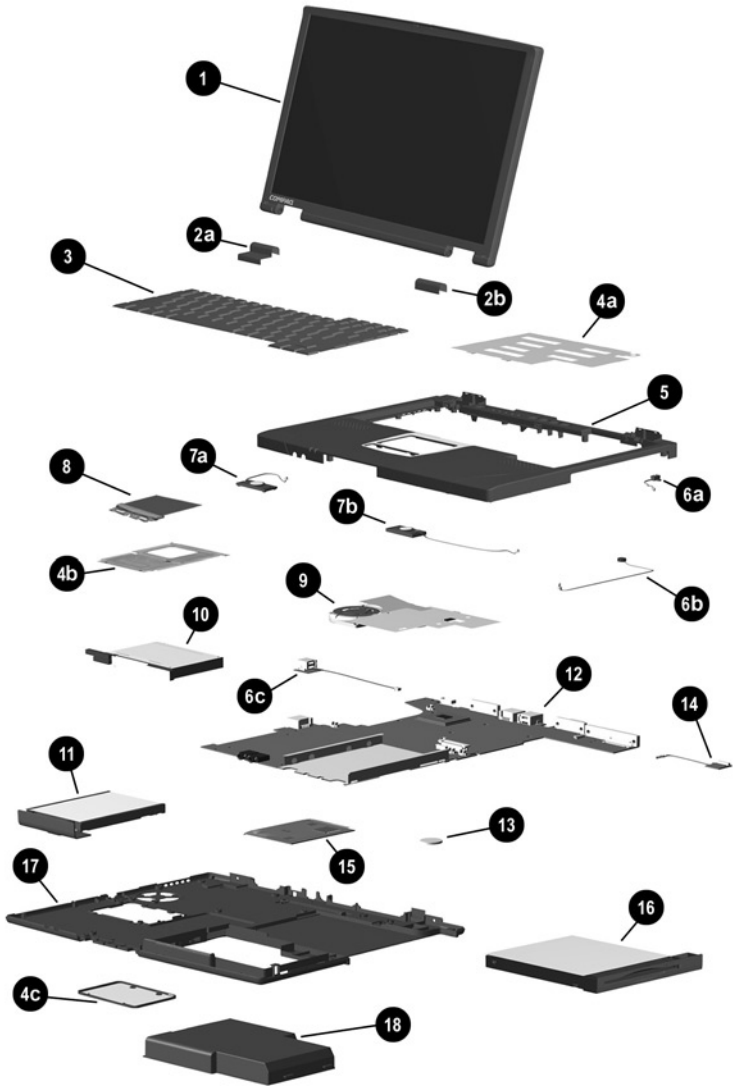

Figure 3-2. Computer System Major Components

**Table 3-1
Computer System Major Components**

Item	Description	Spare Part Number		
1	14.1-inch, XGA, CTFT display	239029-001		
	Miscellaneous Plastics Kit	239039-001		
2a	Left hinge cover	Not Illustrated: ■ Computer feet ■ PC Card doors ■ Hard drive bezel		
2b	Right hinge cover			
	Keyboard			
3	Czech	239054-221	Korean	239054-AD1
	Danish	239054-081	Norwegian	239054-091
	European	239054-021	Portuguese	239054-131
	French	239054-051	Russian	239054-251
	French Canadian	239054-121	Spanish	239054-071
	German	239054-041	Swedish	239054-101
	Hebrew	239054-BB1	Swiss	239054-111
	Hungarian	239054-211	Taiwanese	239054-AB1
	International	239054-002	Turkish	239054-141
	Italian	239054-061	U.K. English	239054-031
	Japanese	239054-291	U.S. English	239054-001
	Miscellaneous Hardware Kit			239052-001
4a	EMI shield			
4b	TouchPad bracket			
4c	Memory expansion compartment cover			
5	Top cover			239044-001
	Cable Kit			239041-001
6a	Display lid switch board			
6b	Microphone			
6c	Modem connector/cable			



Computer System Major Components (continued)

Table 3-1
Computer System Major Components (Continued)

Item	Description	Spare Part Number
	Speakers	239043-001
7a	Left speaker	
7b	Right speaker	
8	TouchPad (TouchPad bracket included in Hardware Kit, spare part number 239052-001)	239046-001
9	Heat sink	239038-001
10	PC Card assembly	239040-001
11	Hard drives	
	15 GB	239037-001
	10 GB	239036-001
12	System boards (includes 64 MB SDRAM)	
	800 MHz Intel Pentium III	239051-001
	700 MHz Intel Celeron	239050-001
13	Disk cell RTC battery	236359-001
14	Infrared board	239045-001

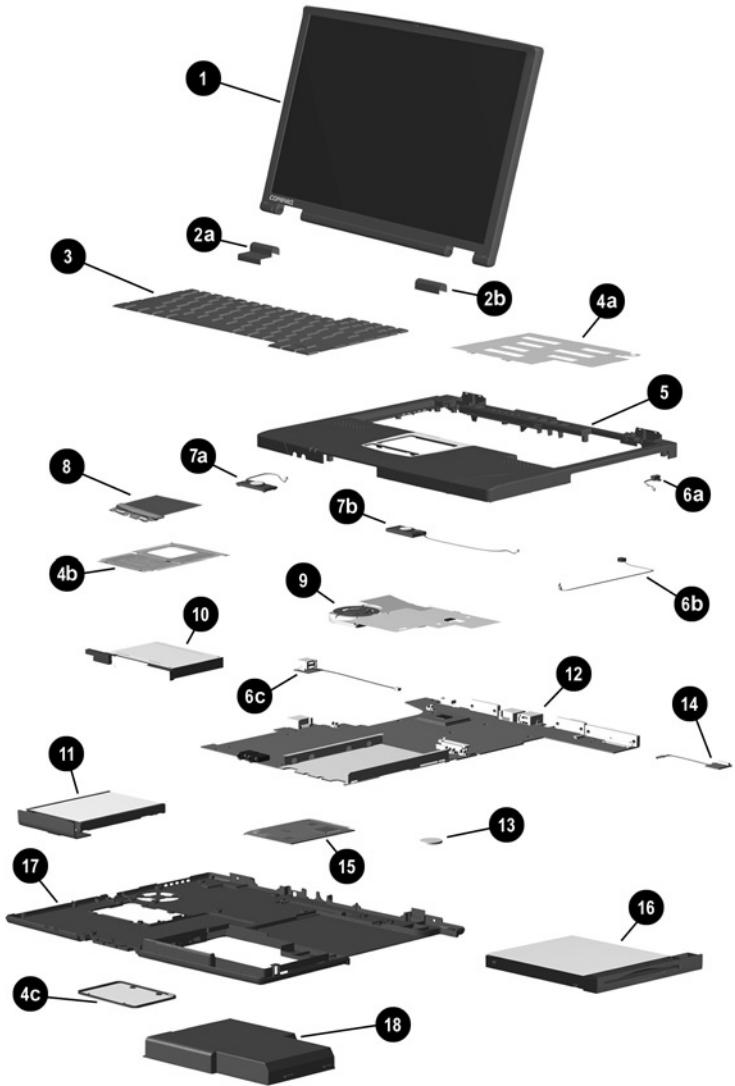

Computer System Major Components (continued)

Table 3-1
Computer System Major Components (Continued)

Item	Description	Spare Part Number
15	Mini PCI Communications Boards	
	Type III mini PCI combination 56 Kbps modem/NIC board	233558-001
	Type III mini PCI 56 Kbps modem board	233557-001
16	Media Bay devices	
	Diskette drive	239035-001
	24X Max CD-ROM drive	239033-001
	CD-RW drive	239034-001
	8X Max DVD-ROM drive	239032-001
17	Base enclosure	239031-001
18	Battery packs	
	8-cell Lithium ion (Li ion)	231962-001
	6-cell Lithium ion (Li ion)	231963-001

3.3 Miscellaneous Plastics Kit Components

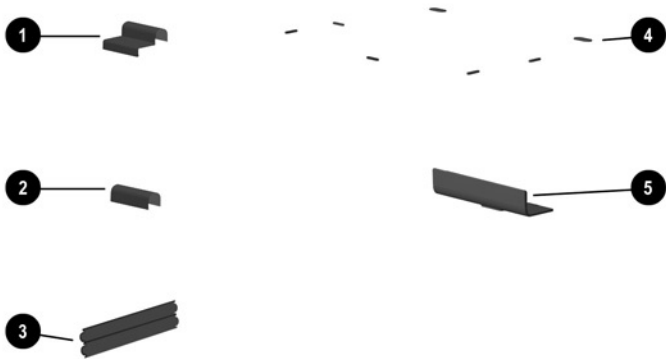

Figure 3-3. Miscellaneous Plastics Kit Components

Table 3-2
Miscellaneous Plastics Kit Components
Spare Part Number 239039-001

Item	Description
1	Left hinge cover
2	Right hinge cover
3	PC Card doors
4	Computer feet
5	Hard drive bezel

3.4 Miscellaneous Hardware Kit Components

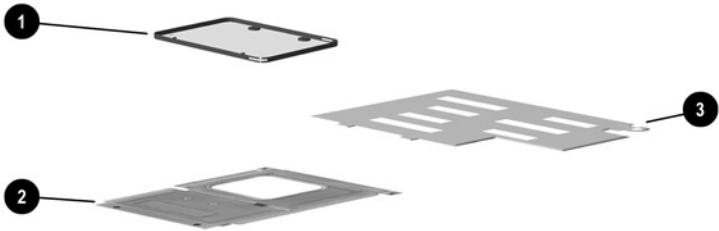

Figure 3-4. Miscellaneous Hardware Kit Components

Table 3-3
Miscellaneous Hardware Kit Components
Spare Part Number 239052-001

Item	Description
1	Memory expansion compartment cover
2	TouchPad bracket
3	EMI shield

3.5 Cable Kit Components

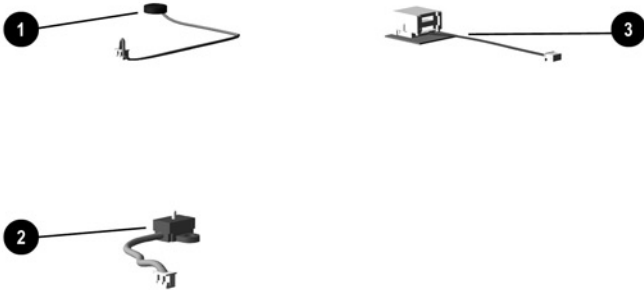

Figure 3-5. Cable Kit Components

Table 3-4
Cable Kit Components
Spare Part Number 239041-001

Item	Description
1	Microphone
2	Display lid switch board
3	Modem connector/cable

3.6 Mass Storage Devices



Figure 3-6. Mass Storage Devices

**Table 3-5
Mass Storage Devices**

Item	Description	Spare Part Number
1	Diskette drive	239035-001
2	Hard drives	
	15 GB	239037-001
	10 GB	239036-001
3	Optical drives	
	24X Max CD-ROM drive	239033-001
	CD-RW drive	239034-001
	8X Max DVD-ROM drive	239032-001

3.7 Miscellaneous

**Table 3-6
Miscellaneous Spare Parts (not illustrated)**

Description			Spare Part Number
Modems			
Type III mini PCI combination 56 Kbps modem/NIC board			233558-001
Type III mini PCI 56 Kbps modem board			233557-001
Modem adapters			
Czech	234963-221	Norwegian	234963-091
German	236432-041	Swiss	198294-111
Hungarian	234963-211		
Modem cable			234962-001
Modem cable adapters			
Australian			304398-011
Belgian			304398-181
French			304398-051
RJ-11 P55 adapters			
Danish	316904-081	Italian	316904-061
Finnish	316904-351	Swedish	316904-101
RJ-11 PTT adapter (used in the United Kingdom)			158593-031
RJ-45 network cable			239049-001

Table 3-6
Miscellaneous Spare Parts (not illustrated) (Continued)

Description	Spare Part Number		
External AC adapter	163444-001		
50W slim AC adapter	163444-291		
Logo kit	233556-001		
Memory expansion boards			
256 MB	167136-001		
128 MB	135244-001		
64 MB	135243-001		
Screw kit (Includes the screws and screwlock listed below. Refer to Appendix C, "Screw Listing," for more information about screw specifications and usage.)	239042-001		
<ul style="list-style-type: none"> ■ M2.5 × 8 ■ M2.5 × 7 ■ M2.5 × 4.5 ■ M2.5 × 3 	<ul style="list-style-type: none"> ■ M2 × 14.5 ■ M2 × 12.5 ■ M2 × 6 ■ M2 × 5.5 ■ M2 × 5 ■ M2 × 4 	<ul style="list-style-type: none"> ■ M1 × 4 ■ 5.0 mm screwlock 	
Power cord, black, 6 feet			
Australian	246959-011	Korean	246959-AD1
Danish	246959-081	Swiss	246959-AG1
European/Middle Eastern/African	246959-021	Taiwanese	234961-AA1
Italian	246959-061	U.K. English	246959-031
Japanese	197233-001	U.S. English	246959-001

Removal and Replacement Preliminaries

This chapter provides essential information for proper and safe removal and replacement service.

4.1 Tools Required

You will need the following tools to complete the removal and replacement procedures:

- Magnetic screwdriver
- Phillips P0 screwdriver
- 5 mm socket
- Tool kit (includes connector removal tool, loopback plugs, and case utility tool)

4.2 Service Considerations

The following sections include some of the considerations that you should keep in mind during disassembly and assembly procedures.



As you remove each subassembly from the computer, place the subassembly (and all accompanying screws) away from the work area to prevent damage.

Plastic Parts

Using excessive force during disassembly and reassembly can damage plastic parts. Use care when handling the plastic parts. Apply pressure only at the points designated in the maintenance instructions.

Cables and Connectors

Cables must be handled with extreme care to avoid damage. Apply only the tension required to unseat or seat the cables during removal and insertion. Handle cables by the connector whenever possible. In all cases, avoid bending, twisting, or tearing cables. Ensure that cables are routed in such a way that they cannot be caught or snagged by parts being removed or replaced. Handle flex cables with extreme care; these cables tear easily.



CAUTION: When servicing the computer, ensure that cables are placed in their proper locations during the reassembly process. Improper cable placement can damage the computer.

4.3 Preventing Damage to Removable Drives

Removable drives are fragile components that must be handled with care. To prevent damage to the computer, damage to a removable drive, or loss of information, observe the following precautions:

- Before removing or inserting a hard drive, shut down the computer. If you are unsure whether the computer is off or in Hibernation, turn the computer on, then shut it down.
- Before removing a diskette drive or optical drive, ensure that a diskette or disc is not in the drive. Ensure that the optical drive tray is closed.

- Before handling a drive, ensure that you are discharged of static electricity. While handling a drive, avoid touching the connector.
- Handle drives on surfaces that have at least one inch of shock-proof foam.
- Avoid dropping drives from any height onto any surface.
- After removing a hard drive, CD-ROM drive, or a diskette drive, place it into a static-proof bag.
- Avoid exposing a hard drive to products that have magnetic fields such as monitors or speakers.
- Avoid exposing a drive to temperature extremes or to liquids.
- If a drive must be mailed, place the drive into a bubble pack mailer or other suitable form of protective packaging and label the package “Fragile: Handle With Care.”

4.4 Preventing Electrostatic Damage

Many electronic components are sensitive to electrostatic discharge (ESD). Circuitry design and structure determine the degree of sensitivity. Networks built into many integrated circuits provide some protection, but in many cases the discharge contains enough power to alter device parameters or melt silicon junctions.

A sudden discharge of static electricity from a finger or other conductor can destroy static-sensitive devices or microcircuitry. Often the spark is neither felt nor heard, but damage occurs. An electronic device exposed to electrostatic discharge may not be affected at all and can work perfectly throughout a normal cycle. The device may function normally for awhile, then degrade in the internal layers, reducing its life expectancy.

4.5 Packaging and Transporting Precautions

Use the following grounding precautions when packaging and transporting equipment:

- To avoid hand contact, transport products in static-safe containers such as tubes, bags, or boxes.
- Protect all electrostatic-sensitive parts and assemblies with conductive or approved containers or packaging.
- Keep electrostatic-sensitive parts in their containers until the parts arrive at static-free workstations.
- Place items on a grounded surface before removing items from their containers.
- Always be properly grounded when touching a sensitive component or assembly.

- Place reusable electrostatic-sensitive parts from assemblies in protective packaging or non conductive foam.
- Use transporters and conveyers made of antistatic belts and roller bushings. Ensure that mechanized equipment used for moving materials is wired to ground and that proper materials were selected to avoid static charging. When grounding is not possible, use an ionizer to dissipate electric charges.

4.6 Workstation Precautions

Use the following grounding precautions at workstations:

- Cover the workstation with approved static-dissipative material (refer to Table 4-2).
- Use a wrist strap connected to a properly grounded work surface and use properly grounded tools and equipment.
- Use conductive field service tools, such as cutters, screwdrivers, and vacuums.
- When using fixtures that must directly contact dissipative surfaces, only use fixtures made of static-safe materials.
- Keep the work area free of nonconductive materials such as ordinary plastic assembly aids and Styrofoam.
- Handle electrostatic-sensitive components, parts, and assemblies by the case or PCM laminate. Handle these items only at static-free workstations.
- Avoid contact with pins, leads, or circuitry.
- Turn off power and input signals before inserting or removing connectors or test equipment.

4.7 Grounding Equipment and Methods

Grounding equipment must include either a wrist strap or a foot strap at a grounded workstation.

- When seated, wear a wrist strap connected to a grounded system. Wrist straps are flexible straps with a minimum of one megaohm $\pm 10\%$ resistance in the ground cords. To provide proper ground, wear a strap snugly against the skin at all times. On grounded mats with banana-plug connectors, connect a wrist strap with alligator clips.
- When standing, use foot straps and a grounded floor mat. Foot straps (heel, toe, or boot straps) can be used at standing workstations and are compatible with most types of shoes or boots. On conductive floors or dissipative floor mats, use foot straps on both feet with a minimum of one-megaohm resistance between the operator and ground. To be effective, the conductive strips must be worn in contact with the skin.

Other grounding equipment recommended for use in preventing electrostatic damage includes:

- Antistatic tape
- Antistatic smocks, aprons, and sleeve protectors
- Conductive bins and other assembly or soldering aids
- Non-conductive foam
- Conductive tabletop workstations with ground cords of one-megaohm resistance
- Static-dissipative table or floor mats with hard tie to ground
- Field service kits
- Static awareness labels
- Material-handling packages

- Non-conductive plastic bags, tubes, or boxes
- Metal tote boxes
- Electrostatic voltage levels and protective materials

Table 4-1 shows how humidity affects the electrostatic voltage levels generated by different activities.

**Table 4-1
Typical Electrostatic Voltage Levels**

Event	Relative Humidity		
	10%	40%	55%
Walking across carpet	35,000 V	15,000 V	7,500 V
Walking across vinyl floor	12,000 V	5,000 V	3,000 V
Motions of bench worker	6,000 V	800 V	400 V
Removing DIPS from plastic tube	2,000 V	700 V	400 V
Removing DIPS from vinyl tray	11,500 V	4,000 V	2,000 V
Removing DIPS from Styrofoam	14,500 V	5,000 V	3,500 V
Removing bubble pack from PCB	26,500 V	20,000 V	7,000 V
Packing PCBs in foam-lined box	21,000 V	11,000 V	5,000 V

 A product can be degraded by as little as 700 volts.

Table 4-2 lists the shielding protection provided by antistatic bags and floor mats.

**Table 4-2
Static-Shielding Materials**

Material	Use	Voltage Protection Level
Antistatic plastic	Bags	1,500 V
Carbon-loaded plastic	Floor mats	7,500 V
Metallized laminate	Floor mats	5,000 V

5

Removal and Replacement Procedures

This chapter provides removal and replacement procedures.

All screws removed during disassembly are P0 Phillips screws. There are 64 screws and screwlocks in 13 different sizes that must be removed and replaced when servicing the computer. Make special note of each screw size and location during removal and replacement.

Refer to Appendix C, “Screw Listing,” for detailed information on screw sizes, locations, and usage.

5.1 Serial Number

Report the computer serial number to Compaq when requesting information or ordering spare parts. The serial number is located on the bottom of the computer (Figure 5-1).



Figure 5-1. Serial Number Location

5.2 Disassembly Sequence Chart

Use the following chart to determine the section number to be referenced when removing computer components.

Table 5-1
Disassembly Sequence Chart

Section	Description	# of Screws Removed
5.3	Preparing the computer for disassembly	0
5.4	Computer feet	0
5.5	Hinge covers	0
5.6	Keyboard	2
5.7	Display	4
5.8	EMI shield	1
5.9	Top cover	18
5.10	TouchPad	5
5.11	Speakers	10
5.12	Microphone	0
5.13	Display lid switch board	1
5.14	Heat sink	5
5.15	Infrared board	1
5.16	System board	11
5.17	PC Card assembly	2
5.18	Mini PCI board	0
5.19	Disk cell real time clock (RTC) battery	0

5.3 Preparing the Computer for Disassembly

Perform the following steps before disassembling the computer. Consult the computer *Hardware Guide* for instructions on the following steps:

1. Turn off the computer.
2. Disconnect the AC Adapter and all external devices.
3. Remove the battery pack.
4. Remove the hard drive.
5. Remove the Media Bay device.

5.4 Computer Feet

The computer feet are adhesive-backed rubber pads. The computer feet are included in the Miscellaneous Plastics Kit (spare part number 239039-001). Refer to Figure 5-2 for the computer feet locations.

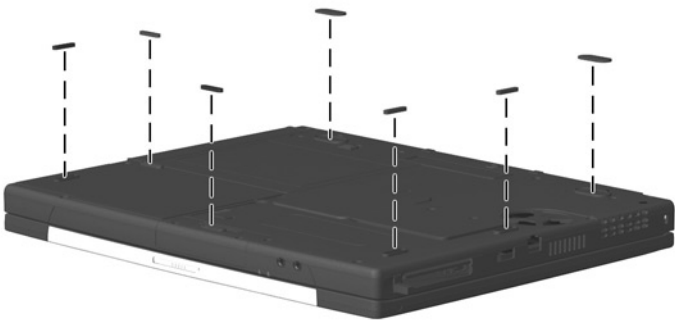

Figure 5-2. Replacing the Computer Feet

5.5 Hinge Covers

The hinge covers are included in the Miscellaneous Plastics Kit (spare part number 239039-001).

1. Prepare the computer for disassembly (Section 5.3).
2. Turn the computer top side up with the front facing you.
3. Open the computer.
4. Use a flat blade screwdriver to pry up on the front edge of the left ❶ and right ❷ hinge covers (Figure 5-3).

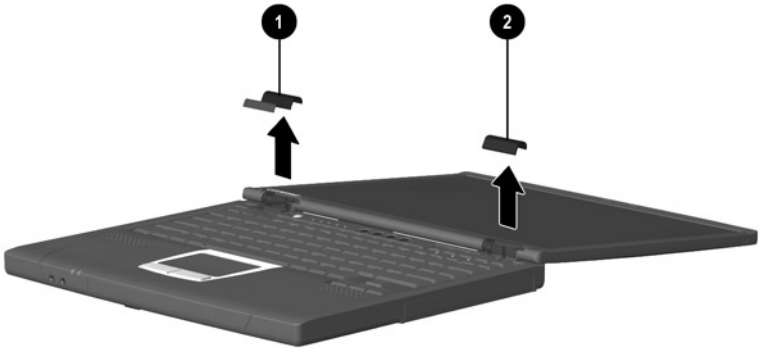

Figure 5-3. Removing the Hinge Covers

5. Remove the hinge covers.

Reverse the above procedure to install the hinge covers.

5.6 Keyboard

Keyboard Cover Spare Part Number Information

Keyboard

Czech	239054-221	Korean	239054-AD1
Danish	239054-081	Norwegian	239054-091
European	239054-021	Portuguese	239054-131
French	239054-051	Russian	239054-251
French Canadian	239054-121	Spanish	239054-071
German	239054-041	Swedish	239054-101
Hebrew	239054-BB1	Swiss	239054-111
Hungarian	239054-211	Taiwanese	239054-AB1
International	239054-002	Turkish	239054-141
Italian	239054-061	U.K. English	239054-031
Japanese	239054-291	U.S. English	239054-001

1. Prepare the computer for disassembly (Section 5.3).
2. Remove the hinge covers (Section 5.5).

3. Remove the two pewter M2.5 × 7.0 screws ❶ that secure the keyboard to the top cover (Figure 5-4).
4. Lift up the back edge of the keyboard and swing it up and forward ❷ until it rests on the top cover.
5. Release the zero insertion force (ZIF) connector ❸ to which the keyboard cable is connected and disconnect the keyboard cable ❹.

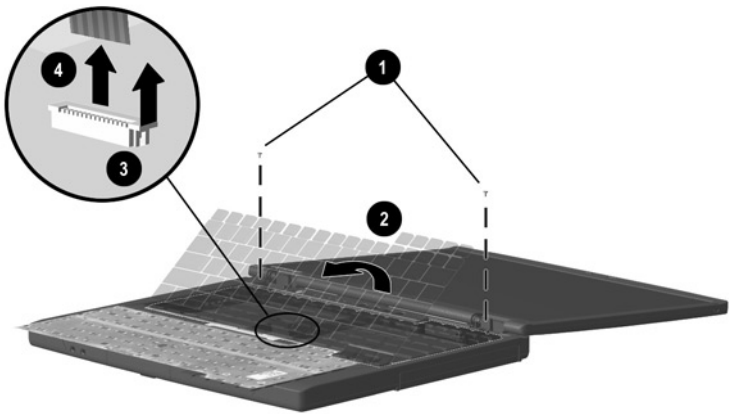

Figure 5-4. Removing the Keyboard

6. Remove the keyboard.

Reverse the above procedure to install the keyboard.

5.7 Display

Display Spare Part Number Information

14.1-inch, XGA, CTFT display

239029-001



When the display screws are removed, the display assembly is unsupported. Make sure to provide support for the display assembly when removing the display screws.

1. Prepare the computer for disassembly (Section 5.3).
2. Remove the hinge covers (Section 5.5).
3. Disconnect the display cable ❶ from the system board (Figure 5-5).
4. Remove the four silver M2.5 × 8.0 screws ❷ that secure the display to the base enclosure.

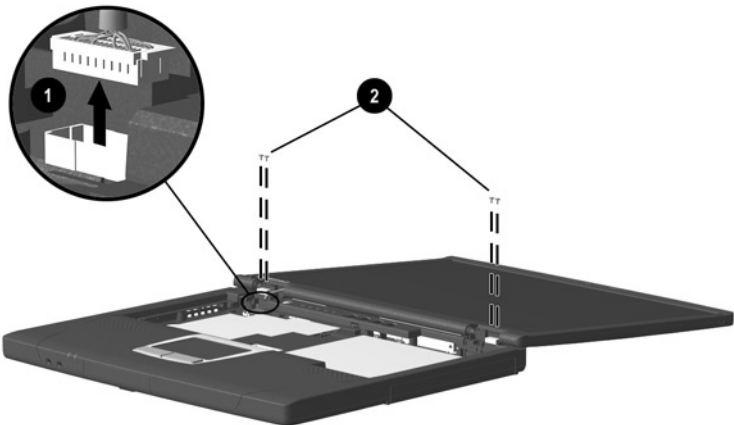

Figure 5-5. Removing the Display

5. Remove the display.



To ensure proper alignment of the display during replacement, loosely install the screws in the ①, ②, ③, ④ sequence indicated in Figure 5-6. Tighten the screws after all four have been loosely installed.

After tightening the display screws, tuck the display cable into the slot ⑤ in the base enclosure.

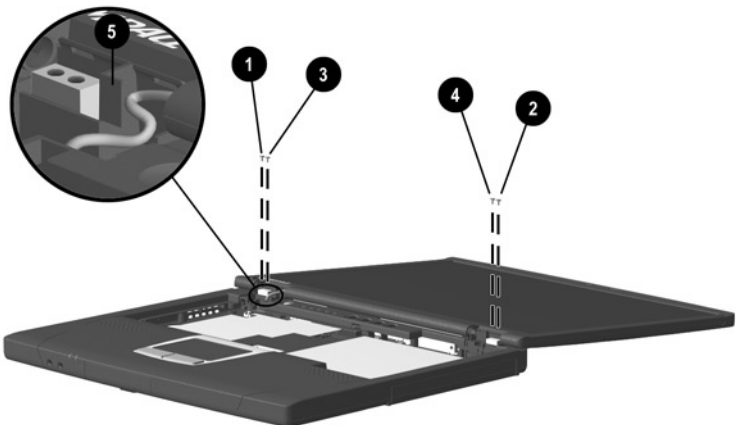

Figure 5-6. Installing the Display Screws

Reverse the above procedure to install the display.

5.8 EMI Shield

The EMI shield is included in the Miscellaneous Hardware Kit (spare part number 239052-001).

1. Prepare the computer for disassembly (Section 5.3) and remove the following components:
 - a. Hinge covers (Section 5.5)
 - b. Keyboard (Section 5.6)
 - c. Display (Section 5.7)
2. Remove the black M2 × 12.5 screw ❶ that secures the EMI shield to the base enclosure (Figure 5-7).
3. Lift the back edge of the EMI shield up and swing it forward ❷, then slide the EMI shield toward the back of the computer at a 45-degree angle ❸.
4. Remove the EMI shield.

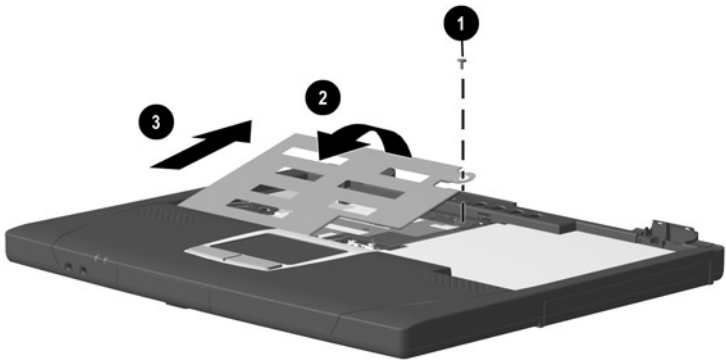

Figure 5-7. Removing the EMI Shield

Reverse the above procedure to install the EMI shield.

5.9 Top Cover

Top Cover Spare Part Number Information

Top cover

239044-001



There are 18 screws in three different sizes that must be removed and replaced during replacement of the top cover. Make special note of each screw size and location when removing and replacing screws.

1. Prepare the computer for disassembly (Section 5.3) and remove the following components:
 - a. Hinge covers (Section 5.5)
 - b. Keyboard (Section 5.6)
 - c. Display (Section 5.7)
 - d. EMI shield (Section 5.8)
2. Turn the computer bottom side up with the rear panel facing you.

3. Remove the following screws:

- ❑ Nine pewter M2.5 × 7.0 screws from the recesses in the bottom of the computer ❶ (Figure 5-8)
- ❑ Two black M2.5 × 4.5 screws ❷ from the bottom of the computer
- ❑ One silver M2 × 5.5 screw ❸ from the battery bay
- ❑ Three black M2.5 × 4.5 screws ❹ from the rear panel of computer

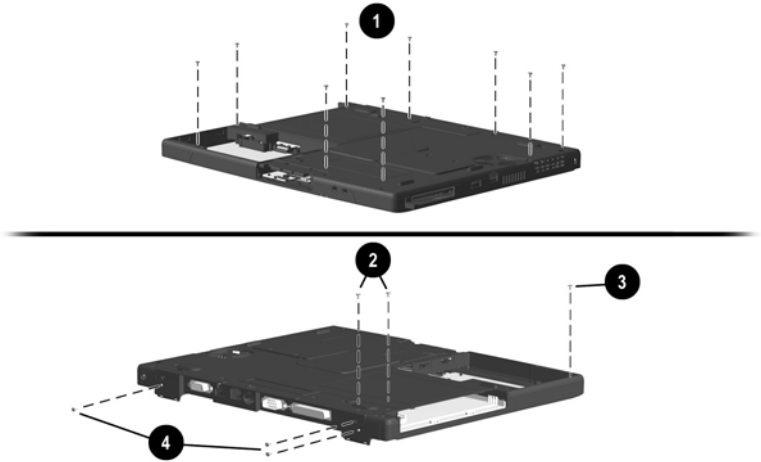

Figure 5-8. Removing the Top Cover Screws

4. Turn the computer top side up with the front facing you.
5. Disconnect the display lid switch board **1**, microphone **2**, and right **3** and left **4** speaker cables (Figure 5-9).
6. Release the ZIF connector **5** to which the TouchPad cable is connected and disconnect the TouchPad cable **6**.

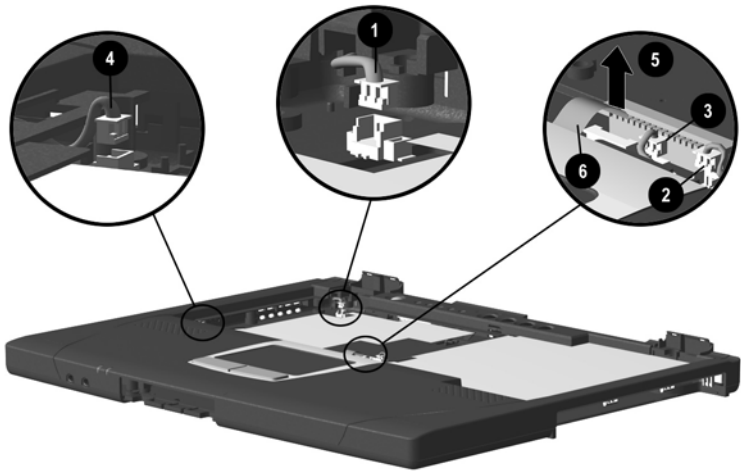

Figure 5-9. Disconnecting Top Cover Connectors

7. Remove the two pewter M2.5 × 7.0 screws ❶ and the black M2.5 × 4.5 screw ❷ that secure the top cover to the base enclosure (Figure 5-10).
8. Lift the back edge of the top cover ❸ and swing it up and forward.

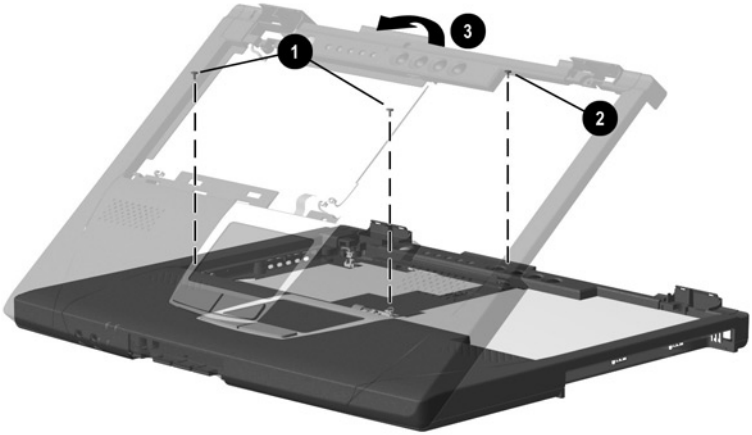

Figure 5-10. Removing the Top Cover

9. Remove the top cover.

Reverse the above procedure to install the top cover.

5.10 TouchPad

TouchPad Spare Part Number Information

TouchPad	239046-001
TouchPad Bracket (included in Miscellaneous Hardware Kit)	239052-001

1. Prepare the computer for disassembly (Section 5.3) and remove the following components:
 - a. Hinge covers (Section 5.5)
 - b. Keyboard (Section 5.6)
 - c. Display (Section 5.7)
 - d. EMI shield (Section 5.8)
 - e. Top cover (Section 5.9)
2. Turn the top cover bottom side up with the front facing you.

3. Remove the two silver M2.5 × 3.0 screws ❶ and the three black M2.5 × 4.0 screws ❷ that secure the TouchPad bracket and TouchPad to the top cover (Figure 5-11).

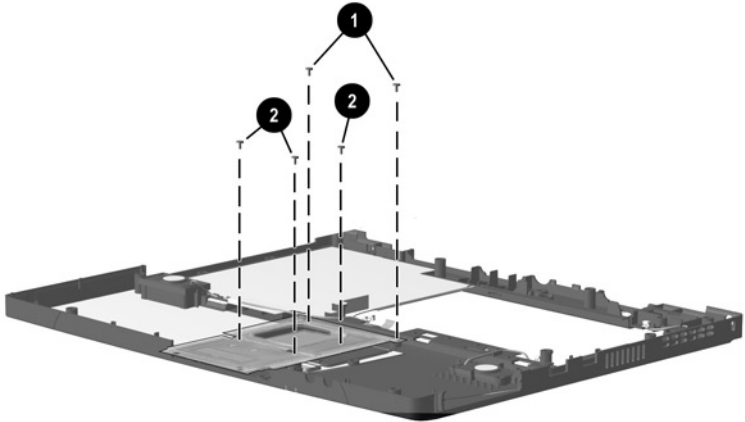

Figure 5-11. Removing the TouchPad Screws

4. Release the ZIF connector ❶ to which the TouchPad cable is attached and disconnect the TouchPad cable ❷ (Figure 5-12).
5. Slide the TouchPad bracket ❸ toward the back of the top cover.
6. Remove the TouchPad bracket ❹ and TouchPad ❺ from the top cover.

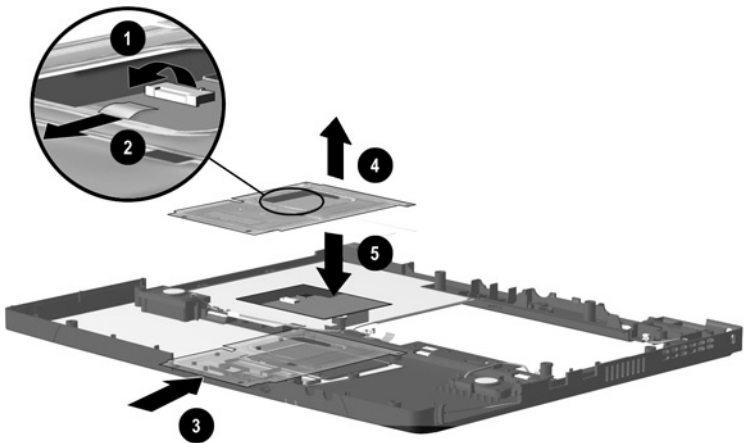

Figure 5-12. Removing the TouchPad

Reverse the above procedure to install the TouchPad.

5.11 Speakers

Speakers Spare Part Number Information

Speakers

239043-001

1. Prepare the computer for disassembly (Section 5.3) and remove the following components:
 - a. Hinge covers (Section 5.5)
 - b. Keyboard (Section 5.6)
 - c. Display (Section 5.7)
 - d. EMI shield (Section 5.8)
 - e. Top cover (Section 5.9)
2. Turn the top cover bottom side up with the front facing you.

3. Remove the two M2.5 × 4.5 screws ❶ that secure the top cover shield to the top cover (Figure 5-13).
4. Remove the right speaker cable from the clips ❷ and ❸ in the top cover shield.

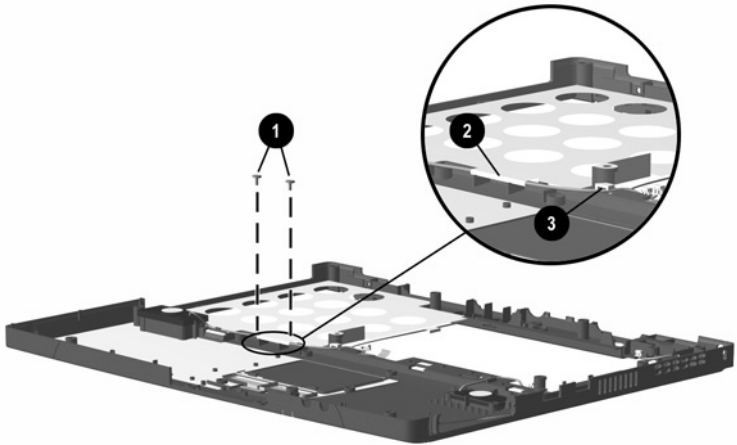

Figure 5-13. Routing the Speaker Cables

5. Remove the eight silver M2 × 5.5 screws ❶ that secure the speakers to the top cover (Figure 5-14).
6. Remove the speakers from the top cover ❷.

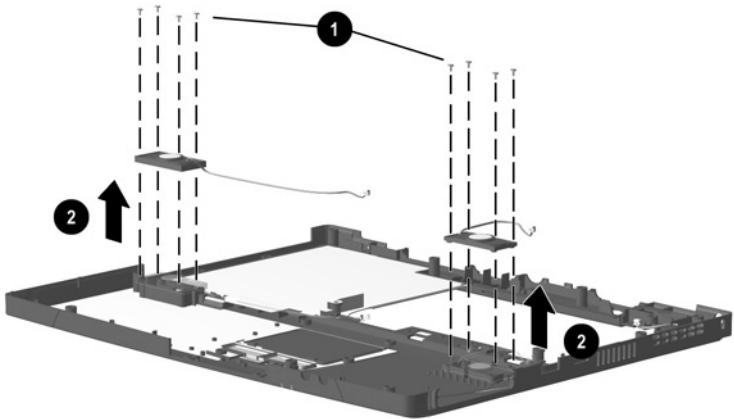

Figure 5-14. Removing the Speakers

Reverse the above procedure to install the speakers.



The left and right speakers are not interchangeable. The right speaker has a longer speaker cable and must be installed in the right speaker position.

5.12 Microphone

The microphone is included in the Cable Kit (spare part number 239041-001).

1. Prepare the computer for disassembly (Section 5.3) and remove the following components:
 - a. Hinge covers (Section 5.5)
 - b. Keyboard (Section 5.6)
 - c. Display (Section 5.7)
 - d. EMI shield (Section 5.8)
 - e. Top cover (Section 5.9)
2. Turn the top cover bottom side up with the front facing you.

3. Remove the microphone from the slot ❶ in which it rests in the top cover (Figure 5-15).
4. Remove the microphone cable from the top cover slot ❷ through which it is routed.
5. Turn the top cover top side up.
6. Remove the microphone cable from the clip ❸ in which it rests in the top cover shield.

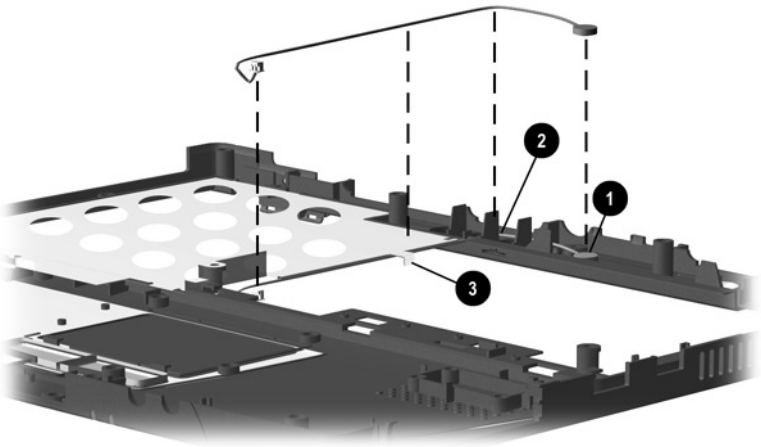

Figure 5-15. Removing the Microphone

Reverse the above procedure to install the microphone.

5.13 Display Lid Switch Board

The display lid switch board is included in the Cable Kit (spare part number 239041-001).

1. Prepare the computer for disassembly (Section 5.3) and remove the following components:
 - a. Hinge covers (Section 5.5)
 - b. Keyboard (Section 5.6)
 - c. Display (Section 5.7)
 - d. EMI shield (Section 5.8)
 - e. Top cover (Section 5.9)
2. Turn the top cover bottom side up with the front facing you.
3. Remove the silver M1 × 4.0 screw ❶ that secures the display lid switch board to the top cover (Figure 5-16).
4. Remove the display lid switch board ❷ from the top cover.

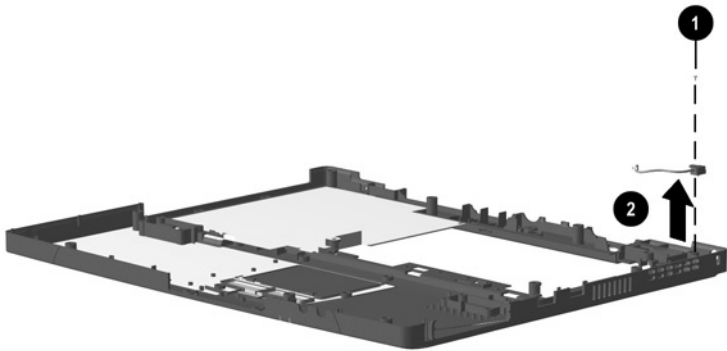

Figure 5-16. Removing the Display Lid Switch Board

Reverse the above procedure to install the display lid switch board.

5.14 Heat Sink



The heat sink assembly includes the fan. The fan should not be removed from the heat sink assembly.

Heat Sink Spare Part Number Information

Heat sink	239038-001
-----------	------------

1. Prepare the computer for disassembly (Section 5.3) and remove the following components:
 - a. Hinge covers (Section 5.5)
 - b. Keyboard (Section 5.6)
 - c. Display (Section 5.7)
 - d. EMI shield (Section 5.8)
 - e. Top cover (Section 5.9)

2. Disconnect the fan cable ❶ from the system board (Figure 5-17).
3. Remove the modem cable from the clip in the heat sink ❷.
4. Remove the four black M2 × 4.0 screws ❸ and the pewter M2.5 × 7.0 screw ❹ that secure the heat sink to the base enclosure.
5. Remove the heat sink.

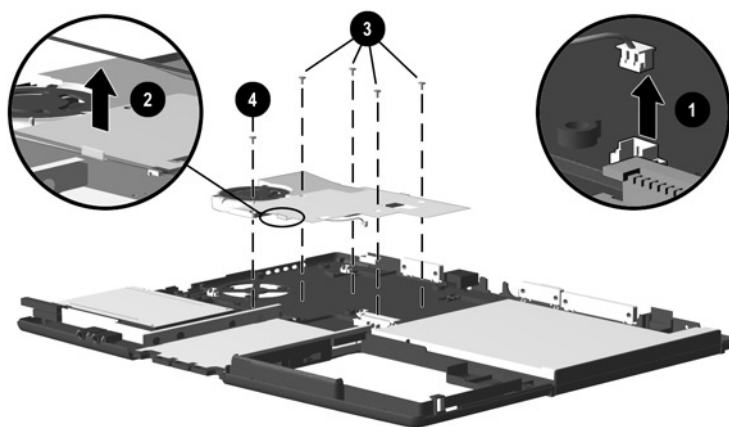

Figure 5-17. Removing the Heat Sink



The fan and heat sink are spared as one assembly. Do not remove the fan from the heat sink.

Reverse the above procedure to install the heat sink.

5.15 Infrared Board

Infrared Board Spare Part Number Information

Infrared board

239045-001

1. Prepare the computer for disassembly (Section 5.3) and remove the following components:
 - a. Hinge covers (Section 5.5)
 - b. Keyboard (Section 5.6)
 - c. Display (Section 5.7)
 - d. EMI shield (Section 5.8)
 - e. Top cover (Section 5.9)

2. Disconnect the infrared board cable ❶ from the system board (Figure 5-18).
3. Remove the infrared board cable from the metal clip ❷ through which it is routed.
4. Remove the black M2 × 4.0 screw ❸ that secures the infrared board to the base enclosure.
5. Lift the infrared board ❹ out of the base enclosure.

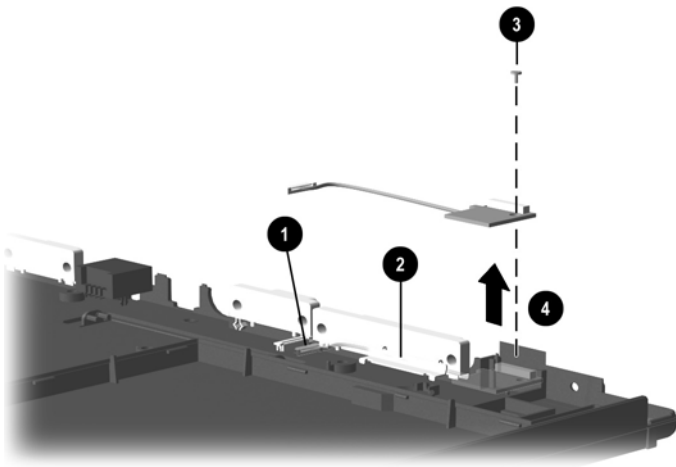

Figure 5-18. Removing the Infrared Board

Reverse the above procedure to install the infrared board.

5.16 System Board



There are 11 screws and screwlocks in five different sizes that must be removed and replaced when replacing the system board. Make special note of each screw size and location when removing and replacing screws.

System Board Spare Part Number Information

System boards (includes 64 MB SDRAM)

800 MHz Intel Pentium III	239051-001
700 MHz Intel Celeron	239050-001

1. Prepare the computer for disassembly (Section 5.3) and remove the following components:
 - a. Hinge covers (Section 5.5)
 - b. Keyboard (Section 5.6)
 - c. Display (Section 5.7)
 - d. EMI shield (Section 5.8)
 - e. Top cover (Section 5.9)
 - f. Infrared board (Section 5.15)
2. Turn the base enclosure top side up with the rear panel facing you.

3. Remove the six 5.0-mm screwlocks from the rear panel of the computer (Figure 5-19).

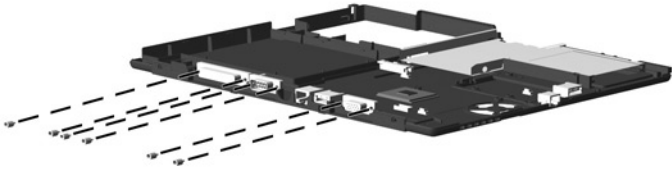

Figure 5-19. Removing the System Board Screwlocks

4. Position the base enclosure so the front faces you.
5. Remove the following screws, as illustrated in Figure 5-20:
 - ❑ two black M2 × 14.5 screws ❶ that secure the PC Card assembly to the base enclosure
 - ❑ black M2.5 × 4.5 screw ❷ near the USB connector that secures the system board to the base enclosure
 - ❑ black M2.5 × 4.0 screw ❸ that secures the modem connector/cable to the base enclosure
 - ❑ black M2 × 4.0 screw ❹ near the display connector that secures the system board to the base enclosure

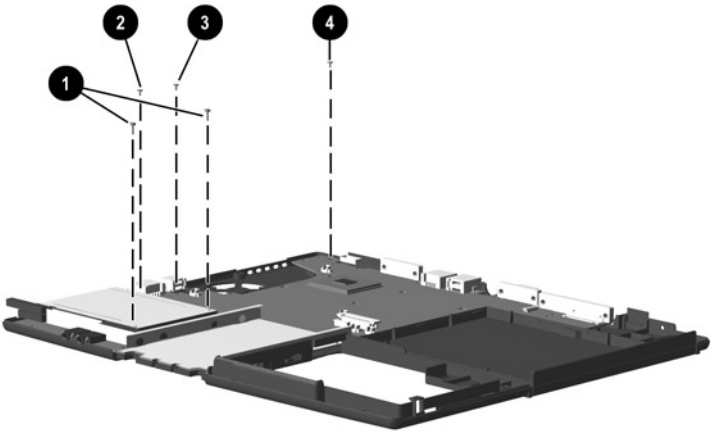



Figure 5-20. Removing the System Board Screws

- Lift up the front edge of the system board ① until the board and the battery connector ② are clear of the base enclosure (Figure 5-21).

 **CAUTION:** When removing the system board, make sure the battery connector ② is carefully routed out of the opening ③ in the base enclosure in which it rests. Failure to follow this caution can result in damage to the battery connector.

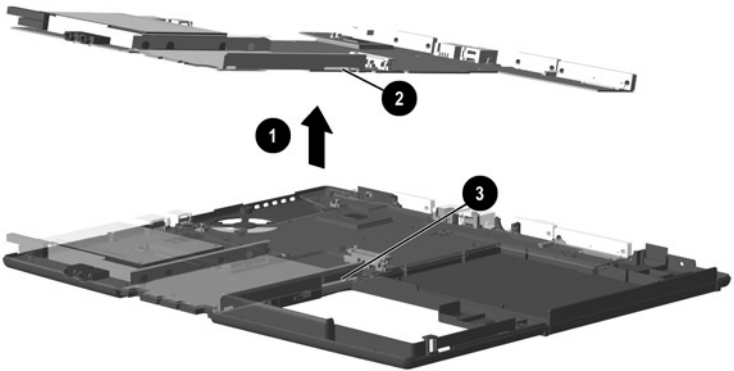

Figure 5-21. *Lifting the System Board*

7. Slide the system board out of the base enclosure at an angle (Figure 5-22).

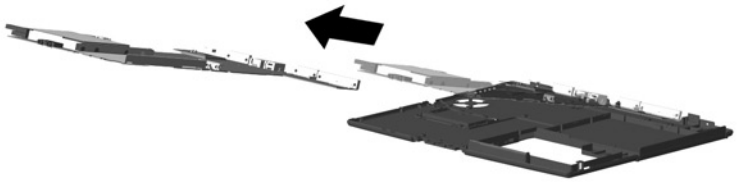

Figure 5-22. Removing the System Board

Reverse the above procedure to install the system board.

5.17 PC Card Assembly

PC Card Assembly Spare Part Number Information

PC Card assembly

239040-001

1. Prepare the computer for disassembly (Section 5.3) and remove the following components:
 - a. Hinge covers (Section 5.5)
 - b. Keyboard (Section 5.6)
 - c. Display (Section 5.7)
 - d. EMI shield (Section 5.8)
 - e. Top cover (Section 5.9)
 - f. Infrared board (Section 5.15)
 - g. System board (Section 5.16)
2. Turn the system board bottom side up with the PC Card slot opening facing you.

3. Peel back the shielding tape that covers the right PC Card screw ❶ (Figure 5-23).
4. Remove the two silver M2 × 5.0 screws ❷ that secure the PC Card assembly to the system board.
5. Turn the system board top side up with the PC Card slot opening facing you.
6. Lift up the back edge of the PC Card assembly to disconnect it from the system board ❸.
7. Remove the PC Card assembly.

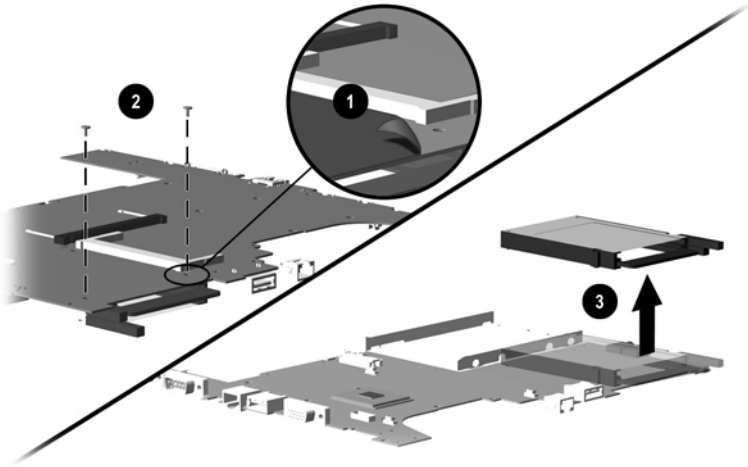

Figure 5-23. Removing the PC Card Assembly

Reverse the above procedure to install the PC Card assembly.

5.18 Mini PCI Board

Mini PCI Board Spare Part Number Information

Mini PCI boards

Type III mini PCI combination 56 Kbps modem/NIC board	233558-001
Type III mini PCI 56 Kbps modem board	233557-001

1. Prepare the computer for disassembly (Section 5.3) and remove the following components:
 - a. Hinge covers (Section 5.5)
 - b. Keyboard (Section 5.6)
 - c. Display (Section 5.7)
 - d. EMI shield (Section 5.8)
 - e. Top cover (Section 5.9)
 - f. Infrared board (Section 5.15)
 - g. System board (Section 5.16)
2. Turn the system board bottom side up with the rear panel facing you.

3. Disconnect the modem connector/cable from the mini PCI board ❶ (Figure 5-24).
4. Set the modem connector/cable aside.
5. Pull away the plastic retention clips on each side of the mini PCI board ❷. The board tilts upward.
6. Lift the edge of the board and slide it out of the mini PCI slot at a 45-degree angle ❸.

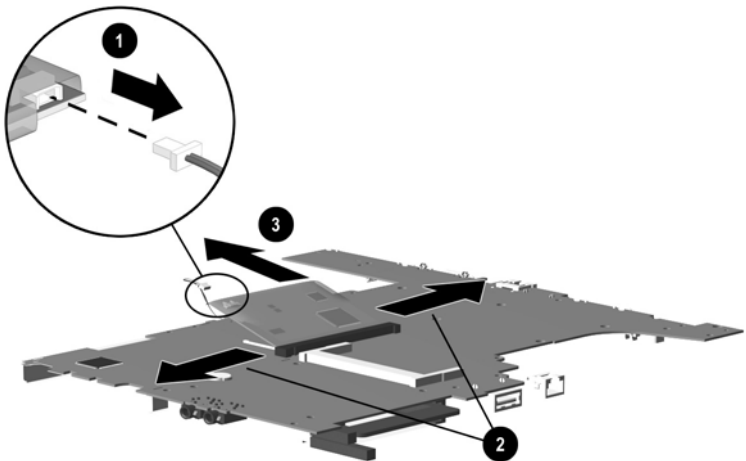

Figure 5-24. Removing the Mini PCI Board

Reverse the above procedure to install the mini PCI board.

5.19 Disk Cell RTC Battery

Disk Cell RTC Battery Spare Part Number Information

Disk cell RTC battery

236359-001

1. Prepare the computer for disassembly (Section 5.3) and remove the following components:
 - a. Hinge covers (Section 5.5)
 - b. Keyboard (Section 5.6)
 - c. Display (Section 5.7)
 - d. EMI shield (Section 5.8)
 - e. Top cover (Section 5.9)
 - f. Infrared board (Section 5.15)
 - g. System board (Section 5.16)
2. Turn the system board bottom side up with the rear panel facing you.

3. Lift the edge of the RTC battery to disconnect and remove it from its socket (Figure 5-25).

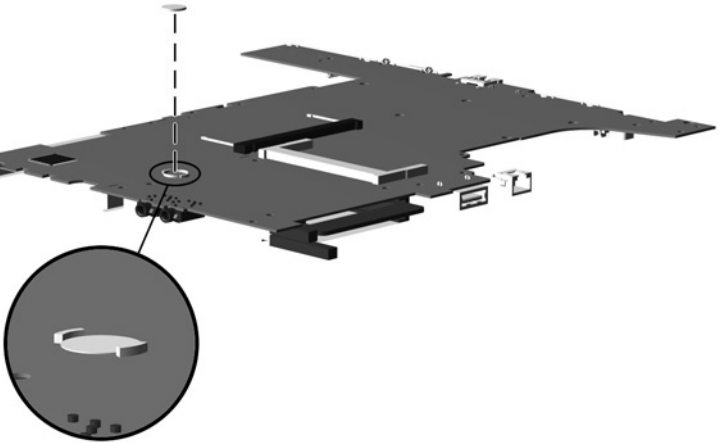

Figure 5-25. Removing the Disk Cell RTC Battery

Reverse the above procedure to install the disk cell RTC battery.

6

Specifications

This chapter provides physical and performance specifications.

Table 6-1
Computer

Dimensions		
Height	12.2 in	309 mm
Depth	1.3 in	34 mm
Width	9.8 in	248 mm
Weight (with 14.1-inch TFT display and Li ion battery)	5.9 lb	2.7 kg
Standalone (Battery) Power Requirements		
Nominal operating voltage (Li ion)	14.8 VDC	
Nominal operating voltage (6-cell Li ion)	11.1 VDC	
AC Adapter Power Requirements		
Operating voltage	100 to 240 VAC RMS nominal	
Operating current	1.3 A RMS	
Operating frequency range	50 to 60 Hz AC nominal	
Maximum transient	4/50 kV	
Temperature		
Operating	50° to 95°F	10° to 35°C
Nonoperating	-4° to 140°F	-20° to 60°C

Table 6-1
Computer (*Continued*)

Relative Humidity (non condensing)

Operating	10 to 90% relative humidity
Nonoperating	5 to 95% relative humidity, 101.6°F/38.7°C Maximum wet bulb temperature

Altitude (unpressurized)

Operating	0 to 10,000 ft	0 to 3,048 m
Nonoperating	0 to 30,000 ft	0 to 9,144 m

Shock

Operating	10 G, 11 ms, half sine
Nonoperating	60 G, 11 ms, half sine

Vibration

Operating	0.5 G zero-to-peak, 10 to 500 Hz, at 0.5 oct/min sweep rate
Nonoperating	1.0 G, zero-to-peak, 10 to 500 Hz, at 0.5 oct/min sweep rate



Applicable product safety standards specify thermal limits for plastic surfaces. The computer operates well within this range of temperatures.

Table 6-2
14.1-inch XGA, TFT Display

Dimensions		
Height	8.42 in	214 mm
Depth	11.22 in	285 mm
Width	14.10 in	358 mm
Number of colors	Up to 262K	
Contrast ratio	180:1	
Brightness	>150 nits typical	
Pixel resolution		
Pitch		0.279 × 0.279 mm
Format	1024 × 768	
Configuration	RGB vertical stripe	
Backlight	Cold cathode fluorescent, 1 tube	
Character display	80 × 25	
Refresh	60 Hz	
Total Power Consumption	8.0 W	

**Table 6-3
Hard Drives**

	15 GB	10 GB
User capacity per drive ¹	15.0 GB	10.0 GB
Drive height (with drive frame)	0.37 in/9.5 mm	0.37 in/9.5 mm
Drive width (with drive frame)	2.5 in/63.5 mm	2.5 in/63.5 mm
Interface type	ATA-5	ATA-5
Seek times (typical read, including setting)		
Single track ³	3.0 ms	3.0 ms
Average ³	13.0 ms	13.0 ms
Full stroke ³	24.0 ms	24.0 ms
User addressable sectors ³	29,498,112	19,640,880
Logical configuration		
Cylinders	16,383	16,683
Heads	16	16
Sectors per track	63	63

**Table 6-3
Hard Drives (Continued)**

	15 GB	10 GB
Physical configuration		
Cylinders ³	25,800	25,800
Heads ³	2	2
Sectors per track ³	398 - 731	398 - 731
Bytes per sector	512	512
Buffer size³	512 KBytes	512 KBytes
Disk rotational speed	4200 rpm	4200 rpm
Transfer rate		
Interface max (Mbytes/sec) ²	100	100
Media (Mbits/sec) ³	155 - 286	155 - 286

¹ 1 GB = 1,000,000,000 bytes

² System capability may differ.

³ Actual drive specifications may differ slightly.

Certain restrictions and exclusions apply. Consult the Compaq Customer Support Center for details.

**Table 6-4
Diskette Drive**

Diskette size	3.5 inch	88 mm
Light	On system	
Height	0.5 in	12.7 mm
Bytes per sector	512	
Sectors per track		
High density	18 (1.44 MB)	15 (1.2 MB)
Low density	9	
Tracks per side		
High density	80	
Low density	80	
Read/write heads	2	
Average seek times		
Track-to-track (high/low)	3 ms	6 ms
Average (high/low)	95 ms	174 ms
Settling time	15 ms	
Latency average	100 ms	

Table 6-5
CD-ROM Drive

Applicable disk	CD-ROM (Mode 1, 2, and 3) CD-XA ready (Mode 2, Form 1 and 2) CD-I ready (Mode 2, Form 1 and 2) CD-R (read only) CD Plus Photo CD (single/multisession) CD-Extra Video CD CD-WO (fixed packets only) CD-Bridge	
Center hole diameter	.59 in	15 mm
Disk diameter	120 mm, 80 m	
Disk thickness	1.2 mm	
Track pitch	1.6 μ	
Access time		
Random	< 150 ms	
Full Stroke	< 300 ms	
Cache buffer	128 KB	
Data transfer rate		
Sustained, 24X	2400 KB/sec (150 KB/sec at 1X)	
Variable	1500 to 3600 KB/sec (10X to 24X)	
Normal PIO Mode 4 (single burst)	16.66 KB/sec	
Startup time	< 8 seconds	
Stop time	< 4 seconds	

Table 6-6
DVD-ROM Drive

Applicable disk	DVD-5, DVD-9, DVD-10 CD-ROM (Mode 1 and 2) CD Digital Audio CD-XA ready (Mode 2, Form 1 and 2) CD-I ready (Mode 2, Form 1 and 2) CD-R (read only) CD Plus Photo CD (single/multisession) CD-Bridge	
Center hole diameter	.59 in	15 mm
Disk diameter	120 mm, 80 mm	
Disk thickness	1.2 mm	
Track pitch	.74 μ	
Access time		
Random	< 150 ms	
Full Stroke	< 225 ms	
Audio output level		
Lineout	0.7 V rms	
Headphone	none	
Cache buffer	128 KB	
Data transfer rate		
Sustained, 1X DVD rate	150 KB/sec	
Sustained, 16X DVD rate	2400 KB/sec	
Sustained, 4X DVD rate	5520 KB/sec	
Normal IO Mode 4 (single burst)	16.6 MB/sec	
Startup time	< 15 seconds	
Stop time	< 6 seconds	

Table 6-7
AC Adapter

Weight

Power supply (input)

Operating voltage	100 to 240 VAC RMS Nominal
Operating current	1.3 A RMS
Operating frequency range	50 to 60 Hz Nominal
Maximum transient	4/50 kV

Table 6-8
Battery Packs

Dimensions

Lithium ion (Li ion)

Height	.82 in	21 mm
Length	3.78 in	96 mm
Width	5.28 in	134 mm
Weight	.86 lb	.39 kg
Cells	8	

Nickel Metal Hydride (NiMH)

Height	.67 in	17 mm
Length	6.16 in	131 mm
Width	5.51 in	140 mm
Weight		
Cells	6	

Energy

Li ion

Voltage	14.8 V
Amp-hour capacity	3.8 Ah
Watt-hour capacity	53.5 Wh

NiMH

Voltage	11.1 V
Amp-hour capacity	3.1 Ah
Watt-hour capacity	34.4 Wh

Environmental requirements

Temperature

Operating	50° to 140°F	10° to 40°C
Nonoperating	-12° to 140°F	-30° to 60°C

Table 6-9
System DMA

Hardware DMA	System Function
DMA0	Available for audio
DMA1	Entertainment audio (default; alternate = DMA0, DMA3, none)
DMA2	Diskette drive
DMA3	ECP parallel port LPT1 (default; alternate = DMA0, none)
DMA4	DMA controller cascading (not available)
DMA5	Available for PC Card
DMA6	not assigned
DMA7	not assigned



 PC Card controller can use DMA 1, 2, or 5.

Table 6-10
System Interrupts

Hardware IRQ	System Function
IRQ0	System timer
IRQ1	Keyboard controller
IRQ2	Cascaded
IRQ3	COM2
IRQ4	COM1
IRQ5	Audio (default)*
IRQ6	Diskette drive
IRQ7	Parallel port
IRQ8	Real time clock (RTC)
IRQ9	Infrared
IRQ10	System use
IRQ11	System use
IRQ12	Internal point stick or external mouse
IRQ13	Coprocessor (not available to any peripheral)
IRQ14	IDE interface (hard drive and optical drive)
IRQ15	System use

 PC Cards may assert IRQ3, IRQ4, IRQ5, IRQ7, IRQ9, IRQ10, IRQ11, or IRQ15. Either the infrared or the serial port may assert IRQ3 or IRQ4.

*Default configuration; audio possible configurations are IRQ5, IRQ7, IRQ9, IRQ10, or none.

Table 6-11
System I/O Addresses

I/O Address (hex)	System Function (shipping configuration)
000 - 00F	DMA controller no. 1
010 - 01F	unused
020 - 021	Interrupt controller no. 1
022 - 024	Opti chipset configuration registers
025 - 03F	unused
02E - 02F	87334 "Super IO" configuration for CPU
040 - 05F	Counter/timer registers
044 - 05F	unused
060	Keyboard controller
061	Port b
062 - 063	unused
064	Keyboard controller
065 - 06F	unused
070 - 071	NMI enable/real time clock
072 - 07F	unused
080 - 08F	DMA page registers
090 - 091	unused
092	Port A
093 - 09F	unused
0A0 - 0A1	Interrupt controller no. 2

Table 6-11
System I/O Addresses (*Continued*)

I/O Address (hex)	System Function (shipping configuration)
0A2 - 0BF	unused
0C0 - 0DF	DMA controller no. 2
0E0 - 0EF	unused
0F0 - 0F1	Coprocessor busy clear/reset
0F2 - 0FF	unused
100 - 16F	unused
170 - 177	Secondary fixed disk controller
178 - 1EF	unused
1F0 - 1F7	Primary fixed disk controller
1F8 - 200	unused
201	Joystick (decoded in ESS1688)
202 - 21F	unused
220 - 22F	Entertainment audio
230 - 26D	unused
26E - 26	unused
278 - 27F	unused
280 - 2AB	unused
2A0 - 2A7	unused
2A8 - 2E7	unused
2E8 - 2EF	Reserved serial port

Table 6-11
System I/O Addresses (*Continued*)

I/O Address (hex)	System Function (shipping configuration)
2F0 - 2F7	unused
2F8 - 2FF	Infrared port
300 - 31F	unused
320 - 36F	unused
370 - 377	Secondary diskette drive controller
378 - 37F	Parallel port (LPT1/default)
380 - 387	unused
388 - 38B	FM synthesizer - OPL3
38C - 3AF	unused
3B0 - 3BB	VGA
3BC - 3BF	Reserved (parallel port/no EPP support)
3C0 - 3DF	VGA
3E0 - 3E1	PC Card controller in CPU
3E2 - 3E3	unused
3E8 - 3EF	Internal modem
3F0 - 3F7	"A" diskette controller
3F8 - 3FF	Serial port (COM1/default)
CF8 - CFB	PCI configuration index register (PCIDIVO-1)
CFC - CFF	PCI configuration data register (PCIDIVO-1)

Table 6-12
System Memory Map

Size	Memory Address	System Function
640 K	00000000 - 0009FFFF	Base memory
128 K	000A0000 - 000BFFFF	Video memory
48 K	000C0000 - 000CBFFF	Video BIOS
160 K	000C8000 - 000E7FFF	unused
64 K	000E8000 - 000FFFFF	System BIOS
15 M	00100000 - 00FFFFFF	Extended memory
58 M	01000000 - 047FFFFF	Super extended memory
58 M	04800000 - 07FFFFFF	unused
2 M	08000000 - 080FFFFF	Video memory (direct access)
4 G	08200000 - FFFFFFFFFF	unused
64 K	FFFF0000 - FFFFFFFF	System BIOS

A

Connector Pin Assignments

Table A-1
Stereo Speaker/Headphone

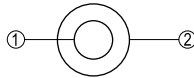

Pin	Signal	Pin	Signal
1	Audio out	2	Ground

Table A-2
Microphone

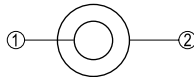

Pin	Signal	Pin	Signal
1	Audio in	2	Ground

Table A-3
External Keyboard/Mouse

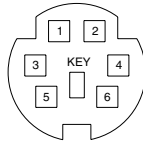

Pin	Signal	Pin	Signal
1	Keyboard/mouse data1	4	+5 VDC
2	Keyboard/mouse data2	5	Keyboard/mouse clock1
3	Ground	6	Keyboard/mouse clock2

Table A-4
RJ-11 Modem



Pin	Signal	Pin	Signal
1	Unused	4	Unused
2	Tip	5	Unused
3	Ring	6	Unused

Table A-5
RJ-45 Network Interface

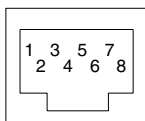

Pin	Signal	Pin	Signal
1	Transmit +	5	Unused
2	Transmit -	6	Receive -
3	Receive +	7	Unused
4	Unused	8	Unused

Table A-6
Universal Serial Bus

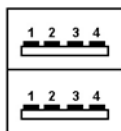

Pin	Signal	Pin	Signal
1	+5 VDC	3	Data +
2	Data -	4	Ground

Table A-7
Serial

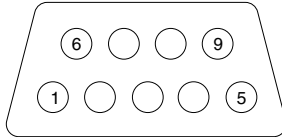

Pin	Signal	Pin	Signal
1	Carrier detect	6	Data set ready
2	Receive data	7	Ready to send
3	Transmit data	8	Clear to send
4	Data terminal ready	9	Ring indicator
5	Signal ground		

Table A-8
External Monitor

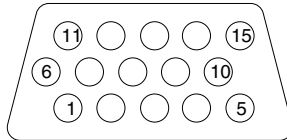

Pin	Signal	Pin	Signal
1	Red analog	9	+5 VDC
2	Green analog	10	Ground
3	Blue analog	11	Monitor detect
4	Not connected	12	DDC 2B data
5	Ground	13	Horizontal sync
6	Ground analog	14	Vertical sync
7	Ground analog	15	DDC2B clock
8	Ground analog		

Table A-9
Parallel

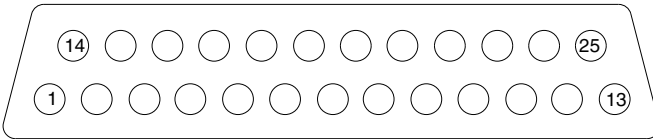

Pin	Signal	Pin	Signal
1	Strobe*	10	Acknowledge*
2	Data bit 0	11	Busy
3	Data bit 1	12	Paper out
4	Data bit 2	13	Select
5	Data bit 3	14	Auto line feed*
6	Data bit 4	15	Error*
7	Data bit 5	16	Initialize printer*
8	Data bit 6	17	Select in*
9	Data bit 7	18-25	Signal ground

*Signal is active low.

Power Cord Set Requirements

3-Conductor Power Cord Set

The computer's wide range input feature permits it to operate from any line voltage from 100 to 120 or 220 to 240 volts AC.

The power cord set received with the computer meets the requirements for use in the country where the equipment is purchased.

Power cord sets for use in other countries must meet the requirements of the country where the computer is used. For more information on power cord set requirements, contact a Compaq authorized reseller or service provider.

General Requirements

The requirements listed below are applicable to all countries:

- The length of the power cord set must be at least 5.00 feet (1.5 m) and a maximum of 6.50 feet (2.0 m).
- All power cord sets must be approved by an acceptable accredited agency responsible for evaluation in the country where the power cord set will be used.
- The power cord set must have a minimum current capacity of 10A and a nominal voltage rating of 125 or 250 volts AC, as required by each country's power system.
- The appliance coupler must meet the mechanical configuration of an EN 60 320/IEC 320 Standard Sheet C13 connector, for mating with appliance inlet on the back of the computer.

Country-Specific Requirements

3-Conductor Power Cord Set Requirements—By Country

Country	Accredited Agency	Applicable Note Number
Australia	EANSW	1
Austria	OVE	1
Belgium	CEBC	1
Canada	CSA	2
Denmark	DEMKO	1
Finland	FIMKO	1
France	UTE	1
Germany	VDE	1
Italy	IMQ	1
Japan	METI	3
The Netherlands	KEMA	1
Norway	NEMKO	1
Sweden	SEMKO	1
Switzerland	SEV	1
United Kingdom	BSI	1
United States	UL	2

Notes

1. The flexible cord must be <HAR> Type HO5VV-F, 3-conductor, 1.0 mm² conductor size. Power cord set fittings (appliance coupler and wall plug) must bear the certification mark of the agency responsible for evaluation in the country where it will be used.

2. The flexible cord must be Type SPT-3 or equivalent, No. 18 AWG, 3-conductor. The wall plug must be a two-pole grounding type with a NEMA 5-15P (15A, 125V) or NEMA 6-15P (15A, 250V) configuration.
3. The appliance coupler, flexible cord, and wall plug must bear a “T” mark and registration number in accordance with the Japanese Dentori Law. The flexible cord must be Type VCT or VCTF, 3-conductor, 1.00mm² conductor size. The wall plug must be a two-pole grounding type with a Japanese Industrial Standard C8303 (7A, 125V) configuration.

C

Screw Listing

This appendix provides specification and reference information for the screws used in the computer. All screws listed in this appendix are available in the Miscellaneous Screw Kit, spare part number 239042-001.

Table C-1
M2.5 × 7.0 Screw

	Color	Qty	Length	Thread	Head Width
	Pewter	14	7.0 mm	M2.5	4.0 mm

Where used: 2 screws securing the keyboard to the top cover (documented in Section 5.6)

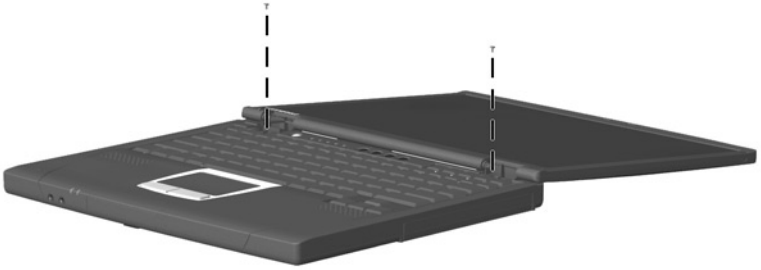



Table C-1
M2.5 × 7.0 Screw (Continued)

	Color	Qty	Length	Thread	Head Width
	Pewter	14	7.0 mm	M2.5	4.0 mm

Where used: 9 screws securing the top cover to the base enclosure (documented in Section 5.9)

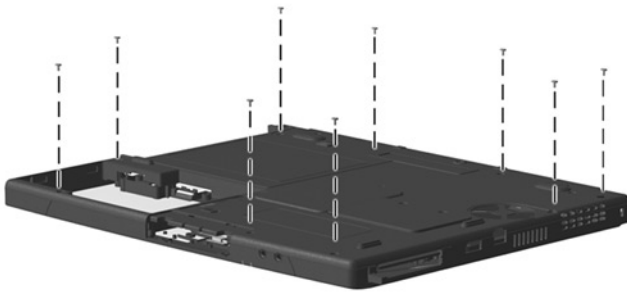



Table C-1
M2.5 × 7.0 Screw (Continued)

	Color	Qty	Length	Thread	Head Width
	Pewter	14	7.0 mm	M2.5	4.0 mm

Where used: 2 screws securing the top cover to the base enclosure (documented in Section 5.9)

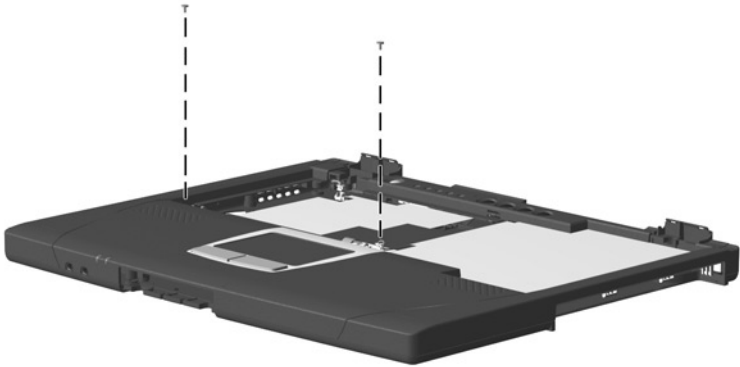



Table C-1
M2.5 × 7.0 Screw (Continued)

	Color	Qty	Length	Thread	Head Width
	Pewter	14	7.0 mm	M2.5	4.0 mm

Where used: 1 screw securing the heat sink to the system board (documented in Section 5.14)

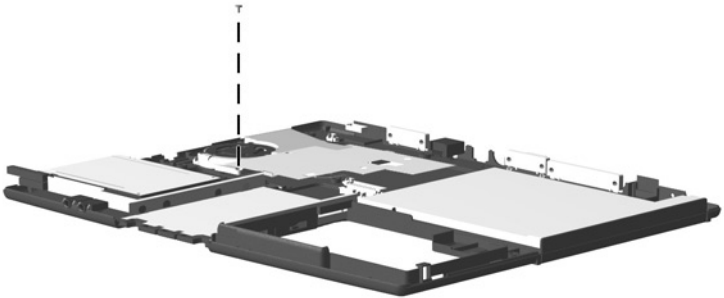

Table C-2
M2.5 × 8.0 Screw



	Color	Qty	Length	Thread	Head Width
	Silver	4	8.0 mm	M2.5	5.0 mm

Where used: 4 screws securing the display to the base enclosure (documented in Section 5.7)

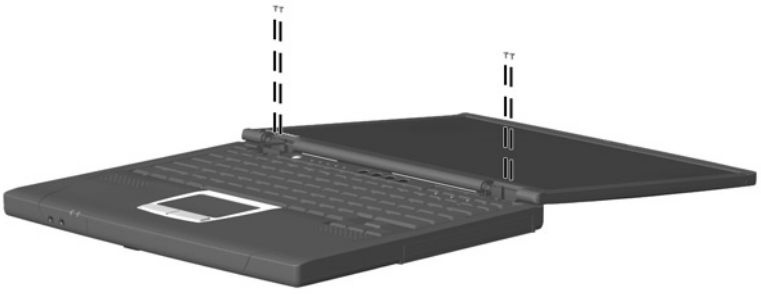



Table C-3
M2 × 5.5 Screw

	Color	Qty	Length	Thread	Head Width
	Silver	1	5.5 mm	M2	4.0 mm

Where used: 1 screw in the battery bay securing the top cover to the base enclosure (documented in Section 5.9)



Table C-4
M2.5 × 4.5 Screw

	Color	Qty	Length	Thread	Head Width
	Black	11	4.5 mm	M2.5	4.0 mm

Where used:

- ❶ 2 screws securing the hard drive to the base enclosure (Refer to the *Hardware Guide* shipped with the computer for installation information.)
 - ❷ 5 screws securing the top cover to the base enclosure (documented in Section 5.9)
-

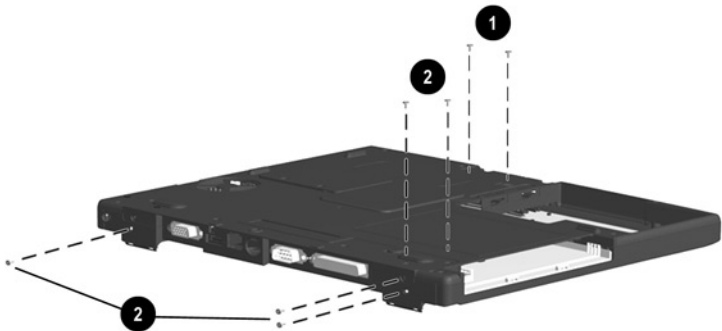



Table C-4
M2.5 × 4.5 Screw (Continued)

	Color	Qty	Length	Thread	Head Width
	Black	11	4.5 mm	M2.5	4.0 mm

Where used:

1 screw securing the top cover to the base enclosure (documented in Section 5.9)

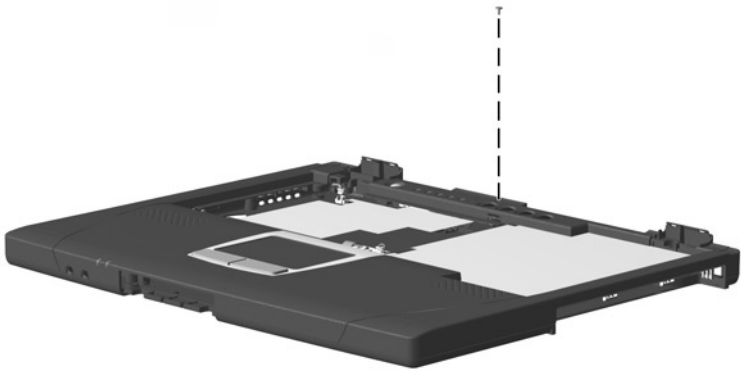



Table C-4
M2.5 × 4.5 Screw (Continued)

	Color	Qty	Length	Thread	Head Width
	Black	11	4.5 mm	M2.5	4.0 mm

Where used:

1 screw near the USB connector securing the system board to the base enclosure (documented in Section 5.16)

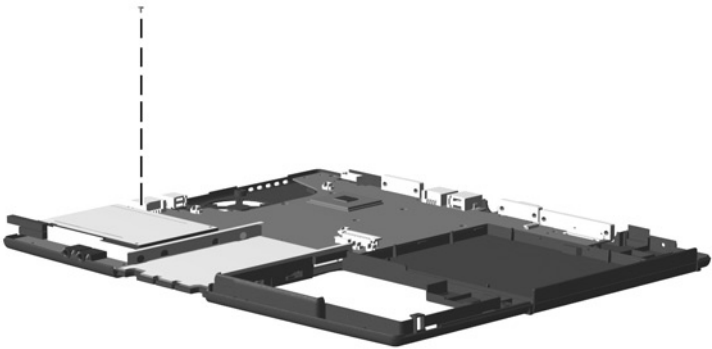



Table C-4
M2.5 × 4.5 Screw (Continued)

	Color	Qty	Length	Thread	Head Width
	Black	11	4.5 mm	M2.5	4.0 mm

Where used:

2 screws securing the top cover shield to the top cover; must be removed in order to remove the right speaker (documented in Section 5.11)

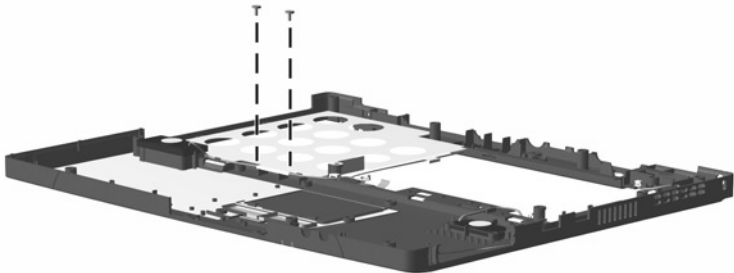

Table C-5
M2 × 12.5



	Color	Qty	Length	Thread	Head Width
	Black	1	12.5 mm	M2	4.5 mm

Where used:

1 screw securing the EMI shield to the base enclosure (documented in Section 5.8)

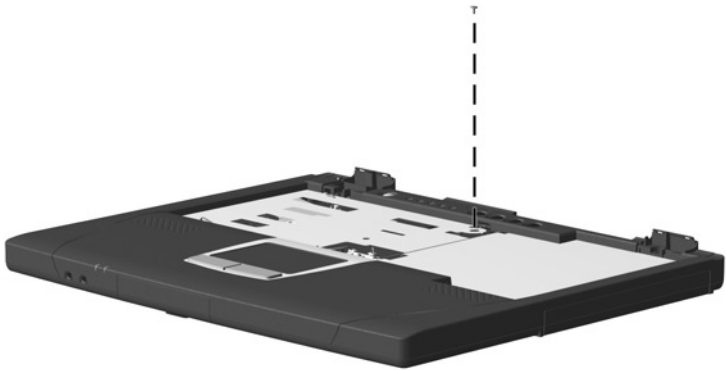



Table C-6
M2.5 × 4.0 Screw

	Color	Qty	Length	Thread	Head Width
	Black	4	4.0 mm	M2.5	4.0 mm

Where used: 3 screws securing the TouchPad bracket to the top cover (documented in Section 5.10)

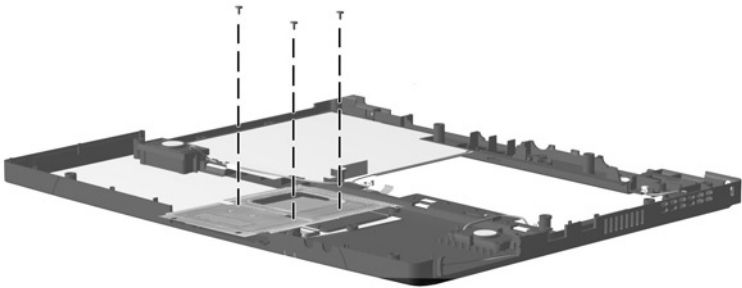



Table C-6
M2.5 × 4.0 Screw (Continued)

	Color	Qty	Length	Thread	Head Width
	Black	4	4.0 mm	M2.5	4.0 mm

Where used:

1 screw securing the modem connector/cable to the base enclosure
(documented in Section 5.16)

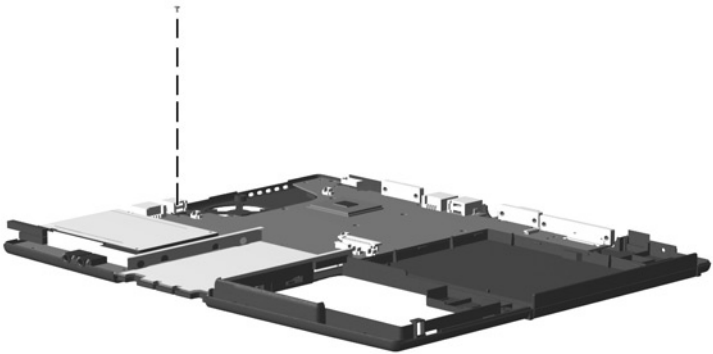



Table C-7
M2.5 × 3.0 Screw

	Color	Qty	Length	Thread	Head Width
	Silver	2	3.0 mm	2.5 mm	3.0 mm

Where used:

2 screws securing the TouchPad bracket to the top cover (documented in Section 5.10)

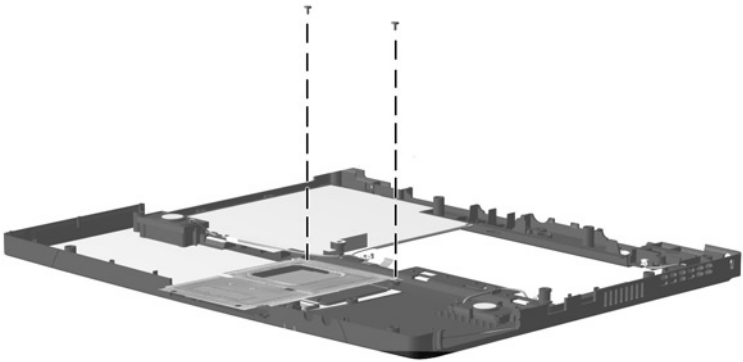



Table C-8
M2 × 6.0 Screw

	Color	Qty	Length	Thread	Head Width
	Silver	8	6.0 mm	M2	3.0 mm

Where used: 8 screws securing the speakers to the top cover (documented in Section 5.11)

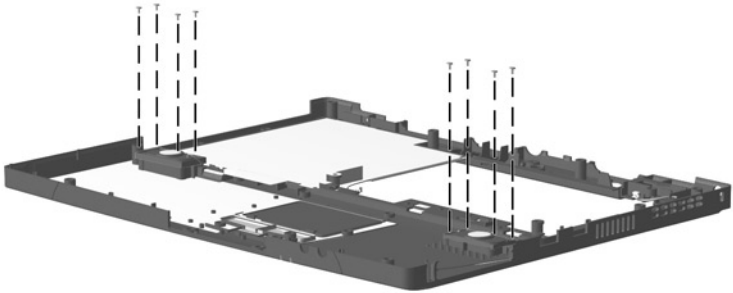



Table C-9
M1 × 4.0 Screw

	Color	Qty	Length	Thread	Head Width
	Silver	1	4.0 mm	M1	3.0 mm

Where used:

1 screw securing the display lid switch board to the top cover (documented in Section 5.13)

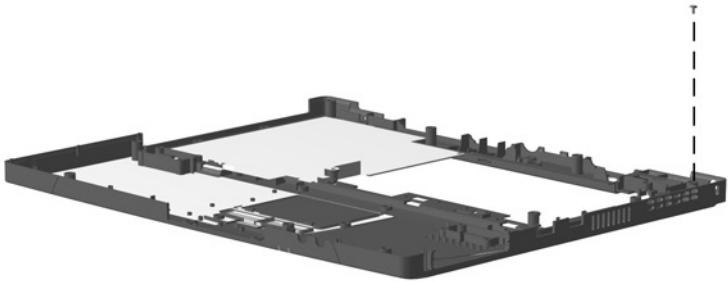



Table C-10
M2 × 4.0 Screw

	Color	Qty	Length	Thread	Head Width
	Black	8	4.0 mm	M2	4.5 mm

Where used:

2 screws securing the memory expansion compartment cover to the base enclosure (Refer to the *Hardware Guide* shipped with the computer for memory installation information.)

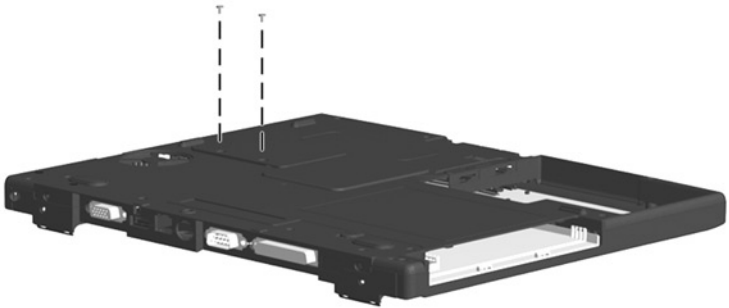



Table C-10
M2 x 4.0 Screw (Continued)

	Color	Qty	Length	Thread	Head Width
	Black	8	4.0 mm	M2	4.5 mm

Where used:

- ❶ 4 screws securing the heat sink to the system board (documented in Section 5.14)
- ❷ 1 screw securing the infrared board to the base enclosure (documented in Section 5.15)
- ❸ 1 screw near the display connector securing the system board to the base enclosure (documented in Section 5.16)

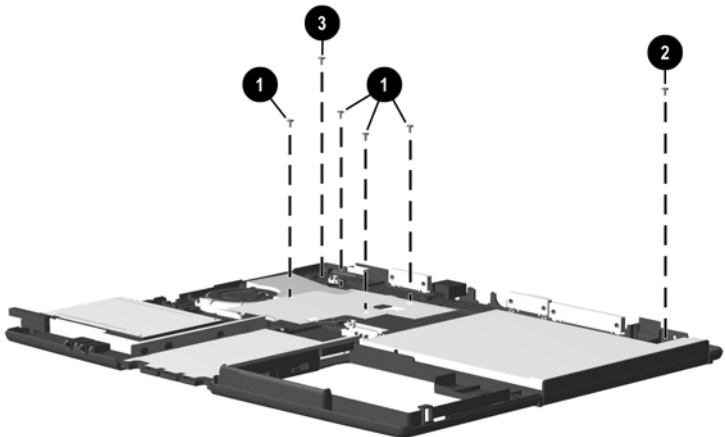

Table C-11
M2 x 14.5 Screw



	Color	Qty	Length	Thread	Head Width
	Black	2	14.5 mm	M2	3.0 mm

Where used:

2 screws securing the system board to the base enclosure (documented in Section 5.16)

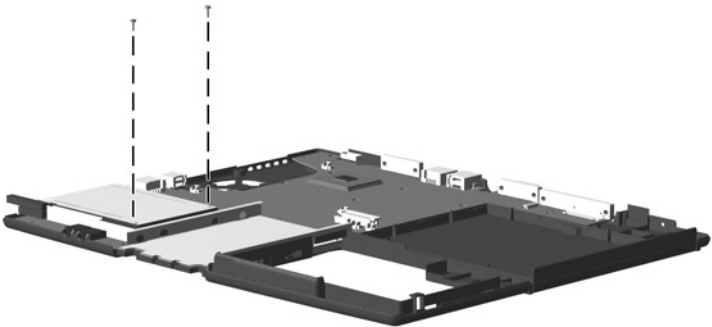



Table C-12
M2 × 5.0 Screw

	Color	Qty	Length	Thread	Head Width
	Silver	2	5.0 mm	2.0 mm	4.0 mm

Where used:

2 screws securing the PC Card assembly to the system board (documented in Section 5.17)

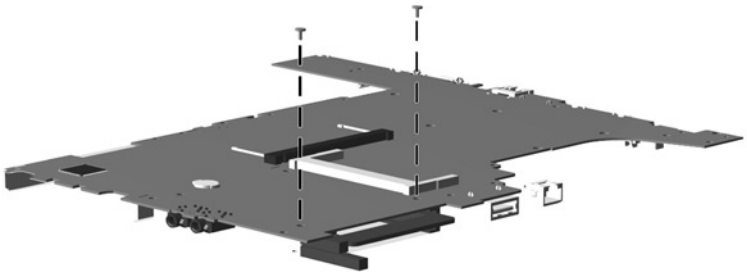

Table C-13
5.0 mm Screwlock



Color	Qty	Length	Socket	Head Width
Silver	6	9.0 mm	5.0 mm	n/a

Where used:

6 screwlocks securing the system board to the base enclosure (documented in Section 5.16)

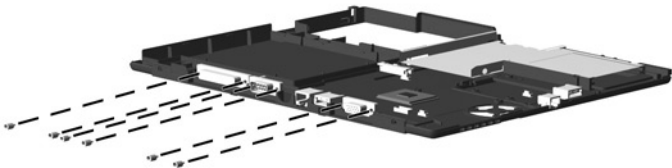

Index

A

- AC adapter
 - spare part numbers 3-13
 - specifications 6-9

B

- base enclosure
 - illustrated 3-6
 - spare part number 3-7
- battery
 - compartment 1-17
 - light 1-9
 - pack
 - illustrated 3-6
 - spare part number 3-7
 - release latch 1-17
 - security switch 1-17
 - specifications 6-10

C

- Cable Kit
 - components 3-10
 - illustrated 3-2
 - spare part number 3-3, 3-10
- cables 4-2
- caps lock

- key 1-13
- light 1-15
- CD-ROM drive
 - illustrated 3-11
 - spare part number 3-11
 - specifications 6-7
- CD-RW drive
 - illustrated 3-11
 - spare part number 3-11
- components
 - bottom 1-16
 - front 1-8
 - keyboard 1-12
 - left side 1-8
 - rear 1-10
 - right side 1-10
 - top 1-14
- computer
 - models 1-2
 - specifications 6-1
- computer feet
 - illustrated 3-8
 - locations 5-4
- connector pin assignments
 - keyboard connector A-2
 - mouse connector A-2

- connector pin assignments
 - external monitor connector
 - A-5
 - headphone jack A-1
 - microphone jack A-1
 - modem jack A-2
 - network interface jack A-3
 - parallel connector A-6
 - RJ-11 jack A-2
 - RJ-45 jack A-3
 - serial connector A-4
 - speaker jack A-1
 - universal serial bus (USB)
 - connector A-3
- connectors 4-2
- cursor control keys 1-13
- D**
 - design overview 1-18
 - disassembly sequence chart
 - 5-3
 - diskette drive
 - illustrated 3-11
 - light 1-15
 - spare part number 3-11
 - specifications 6-6
 - display
 - illustrated 3-2
 - installation 5-9
 - lid switch board
 - illustrated 3-10
 - removal 5-23
 - removal 5-8
 - spare part number 3-3, 5-8
 - specifications 6-3
 - DMA specifications 6-11
 - drive light indicator 1-14
 - drives, preventing damage 4-2
 - DVD-ROM drive
 - illustrated 3-11
 - spare part number 3-11
 - specifications 6-8
- E**
 - Easy Access buttons 1-15
 - electrostatic
 - damage, preventing 4-4
 - voltage levels 4-7
 - embedded numeric keypad
 - 1-13
 - EMI shield
 - illustrated 3-9
 - removal 5-10
 - external monitor connector
 - location 1-11
 - pin assignments A-5
- F**
 - fan 1-17
 - features 1-5
 - Fn key 1-13
 - function keys 1-13
- G**
 - grounding
 - equipment 4-6
 - methods 4-6

H

- hard drive
 - bezel, illustrated 3-8
 - illustrated 1-9, 1-17, 3-4, 3-11
 - spare part number 3-5, 3-11
 - specifications 6-4
- headphone jack
 - illustrated 1-9
 - pin assignments A-1
- heat sink
 - illustrated 3-4
 - removal 5-24
 - spare part number 3-5, 5-24
- hinge cover
 - illustrated 3-8
 - removal 5-5

I

- I/O address specifications 6-13
- illustrated parts catalog 3-1
- infrared board
 - illustrated 3-4
 - removal 5-26
 - spare part number 3-5, 5-26
- infrared port 1-10
- interrupt specifications 6-12

K

- keyboard
 - components 1-12
 - connector, illustrated 1-11
 - illustrated 3-2
 - spare part number 3-3, 5-6

L

- Logo Kit, spare part number 3-13

M

- mass storage device
 - illustrated 3-11
 - spare part number 3-11
- Media Bay
 - device
 - illustrated 3-6
 - spare part number 3-7
 - illustrated 1-10, 1-17
 - release latch 1-16
- memory expansion board, spare part number 3-13
- memory expansion compartment cover
 - illustrated 3-9
 - location 1-17
- memory map specifications 6-16
- microphone
 - illustrated 1-15, 3-10
 - jack, pin assignments A-1
 - removal 5-21
- Miscellaneous Hardware Kit
 - components 3-9
 - illustrated 3-2
 - spare part number 3-3, 3-9

- Miscellaneous Plastics Kit
 - components 3–8
 - illustrated 3–2
 - spare part number 3–3, 3–8
- modem
 - adapter, spare part number 3–12
 - cable adapter, spare part number 3–12
 - cable, spare part number 3–12
 - connector/cable
 - illustrated 3–10
 - illustrated 3–6
 - jack, pin assignments A–2
 - removal 5–35
 - spare part number 3–7, 3–12, 5–35
- modem/NIC
 - illustrated 3–6
 - spare part number 3–7, 5–35
- mouse connector
 - illustrated 1–11

N

- network interface card (NIC)
 - jack, pin assignments A–3
- num lock light 1–15
- numeric keypad 1–13

P

- packing precautions 4–4
- parallel connector
 - location 1–11
 - pin assignments A–6

- parts catalog 3–1
- password, clearing 1–6
- PC Card
 - assembly
 - illustrated 3–4
 - removal 5–33
 - spare part number 3–5, 5–33
 - door 3–8
 - ejector buttons 1–9
 - slot 1–9
- plastic parts 4–2
- power button 1–14
- power cord
 - 3-conductor set B–1
 - country-specific requirements B–2
 - general requirements B–1
 - notes B–2
 - set requirements B–1
 - spare part numbers 3–13
- power jack 1–11
- power light 1–9
- Power Management 1–7

R

- real time clock (RTC) battery
 - illustrated 3–4
 - removal 5–37
 - spare part number 3–5, 5–37
- removal
 - preliminaries 4–1
 - procedures 5–1

- replacement
 - preliminaries 4-1
 - procedures 5-1
- reset button 1-17
- RJ-11 jack
 - location 1-9
 - pin assignments A-2
- RJ-11 P55 adapter, spare part number 3-12
- RJ-11 PTT adapter, spare part number 3-12
- RJ-45 jack
 - location 1-11
 - pin assignments A-3
- RJ-45 network cable, spare part number 3-12
- S**
- Screw Kit
 - components C-1
 - spare part number 3-13
- screw listing C-1
- scroll lock light 1-15
- security cable slot 1-8
- serial connector
 - location 1-11
 - pin assignments A-4
- serial number location 1-16, 3-1, 5-2
- service considerations 4-1
- speaker jack pin assignments A-1
- speakers 1-15
 - illustrated 3-4
 - removal 5-18
 - spare part number 3-5, 5-18
- specifications
 - AC adapter 6-9
 - battery 6-10
 - CD-ROM drive 6-7
 - computer 6-1
 - diskette drive 6-6
 - display 6-3
 - DMA 6-11
 - DVD-ROM drive 6-8
 - hard drive 6-4
 - I/O addresses 6-13
 - interrupts 6-12
 - memory map 6-16
- static shielding materials 4-7
- stereo line-in jack, illustrated 1-9
- stereo line-out jack, illustrated 1-9
- system board
 - illustrated 3-4
 - removal 5-28
 - spare part number 3-5, 5-28

T

- tools required 4–1
- top cover
 - illustrated 3–2
 - removal 5–11
 - spare part number 3–3, 5–11
- TouchPad
 - bracket
 - illustrated 3–9
 - removal 5–15
 - button 1–15
 - illustrated 1–15, 3–4
 - removal 5–15
 - spare part number 3–5, 5–15
- transporting precautions 4–4

- troubleshooting
 - flowcharts 2–3
 - overview 2–1

U

- universal serial bus (USB)
 - connector
 - illustrated 1–9, 1–11
 - pin assignments A–3

V

- vents 1–8, 1–9

W

- Windows application key 1–13
- Windows logo key 1–13
- workstation precautions 4–5