

Gateway Profile™ 4
service guide

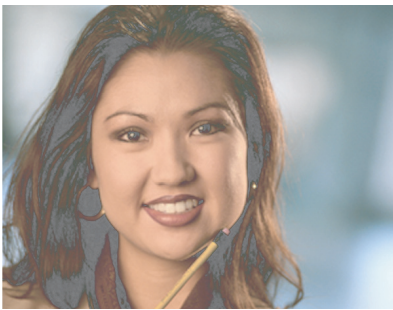

Customizing

Troubleshooting

Gateway®

Contents

Replacing Components in Your Gateway Profile 4.....		1
A	1
P	
P	3
P	4
R	4
	R	5
	R	1
	R	1
R	M PCI	3
I	DIMM	3
R	3
R	LCD	43
R	51



Replacing Components in Your Gateway Profile 4

About this guide

Use this service guide to help plan your maintenance tasks for the Gateway Profile 4. All tasks covered in this guide can be performed by a field technician without jeopardizing your computer's warranty.

For information on your computer's general maintenance, technical support, safety notices, and regulatory notices, see your Gateway user's guide.

If you have suggestions regarding the content of this guide, send an e-mail with the subject "Service Guide Comments" to channel.services@gateway.com.

© 2003 Gateway, Inc. All rights reserved. Gateway, Gateway Country, the Gateway stylized logo, and the black-and-white spot design are trademarks or registered trademarks of Gateway, Inc. in the United States and other countries. All other brands and product names are trademarks or registered trademarks of their respective companies.



Thank you for purchasing this Factory Service Manual CD/DVD from servicemanuals4u.com.

Please check out our eBay auctions for more great deals on Factory Service Manuals:

servicemanuals4u

Preparing your work space

Before performing maintenance on your computer, make sure that your work space and your computer are correctly prepared.

- Wear a grounding (ESD) wrist strap.
- Use a grounded or dissipative work mat.
- Use a stable and strong table.
- Make sure that the table top is large enough to hold each component as you remove it.
- Use bright lighting to make part identification easier.
- Keep your work surface free from clutter and dust that may damage components.
- Use a magnetized screwdriver for removing screws.
- As you remove components and screws, lay them toward the back of your work surface (behind your computer) or far enough to the side that your arms do not accidentally brush components or screws onto the floor.
- To help keep track of screws, try the following:
 - Place each component's screws in their own section of a parts sorter.
 - Place each component's screws next to the component on your work surface.
 - When you place flat-headed screws on your work surface, stand them on their heads to prevent the screws from rolling off the table.

Preventing static electricity discharge

The components inside your computer are extremely sensitive to static electricity, also known as *electrostatic discharge* (ESD).

Warning



ESD

ESD

ESD

.P

Warning



Before opening the computer case, follow these guidelines:

- Turn off the computer power.
- Wear a grounding wrist strap (available at most electronics stores) and attach it to a bare metal part of your workbench or other grounded connection.

Warning



- Touch a bare metal surface on your workbench or other grounded object.
- Unplug the power cord and network cables.

Before working with computer components, follow these guidelines:

- Avoid static-causing surfaces such as carpeted floors, plastic, and packing foam.
- Remove components from their antistatic bags only when you are ready to use them. Do not lay components on the outside of antistatic bags because only the inside of the bags provide electrostatic protection.
- Avoid touching the edge connectors and components on the Mini-PCI cards. Never slide Mini-PCI cards or components over any surface.

Preparing your computer

Warning



To prepare your computer:

- 1 Turn off your computer.
- 2 Following all static electricity discharge precautions, disconnect the power cord and all other external cables.
- 3 Press the power button to drain any residual power from your computer.



Replacing drives

Use the procedures in this section to replace the:

- Diskette drive
- Optical drive
- Hard drive

Tools you need to complete these tasks:



P

Replacing the diskette drive

The removable drive pack contains the diskette drive, drive adapter card, and an optical drive.

 **To replace the diskette drive:**

- 1** Turn off the computer and prepare it by following the instructions in “Preparing your computer” on page 4.
- 2** Remove the two retaining screws located on either side of the Microsoft Certificate of Authenticity label on the back of your computer.

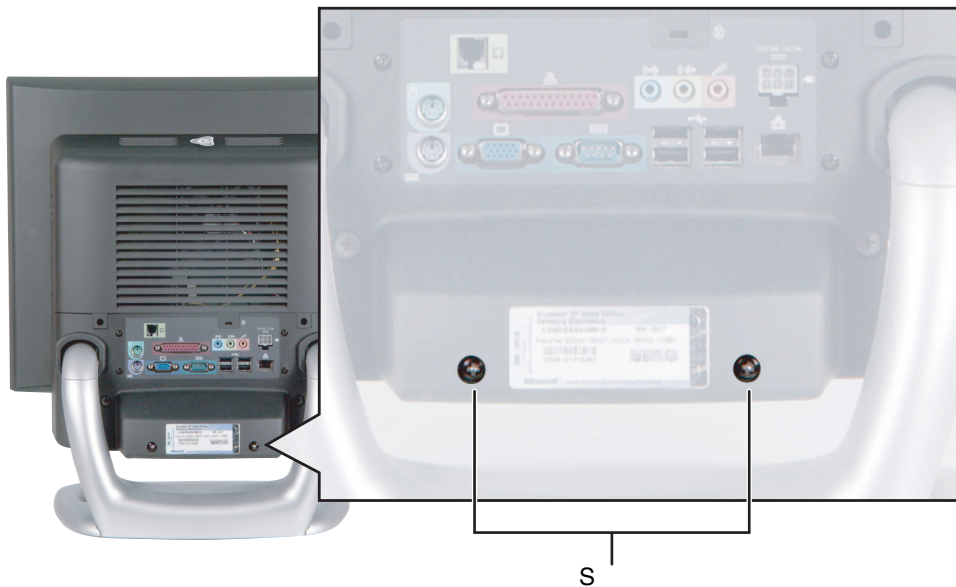

- 3 Slide the drive pack forward, then down.



- 4 Disconnect the two drive cables from the drive adapter card. Note the location and orientation of each cable. You will reconnect these cables later.

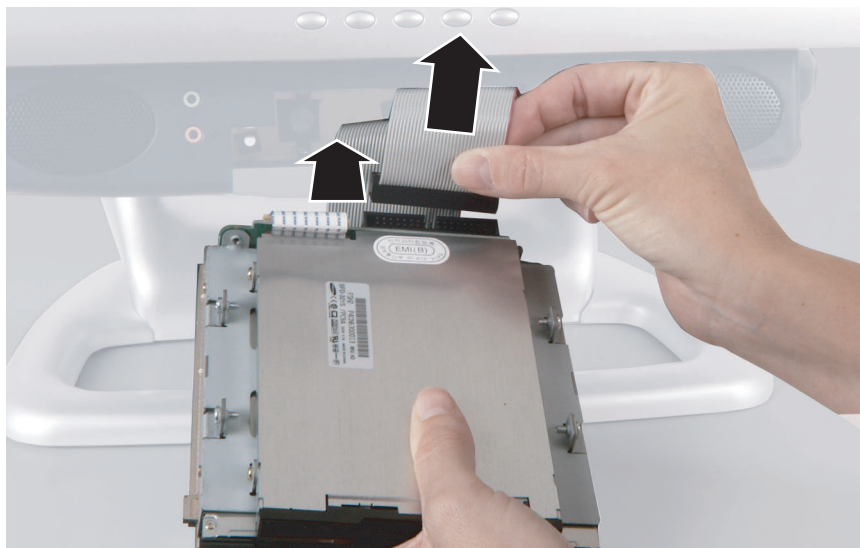

- 5 Disconnect the diskette drive cable from the ZIF connector on the drive adapter card.



- 6 Remove the four screws that secure the diskette drive to the drive pack.

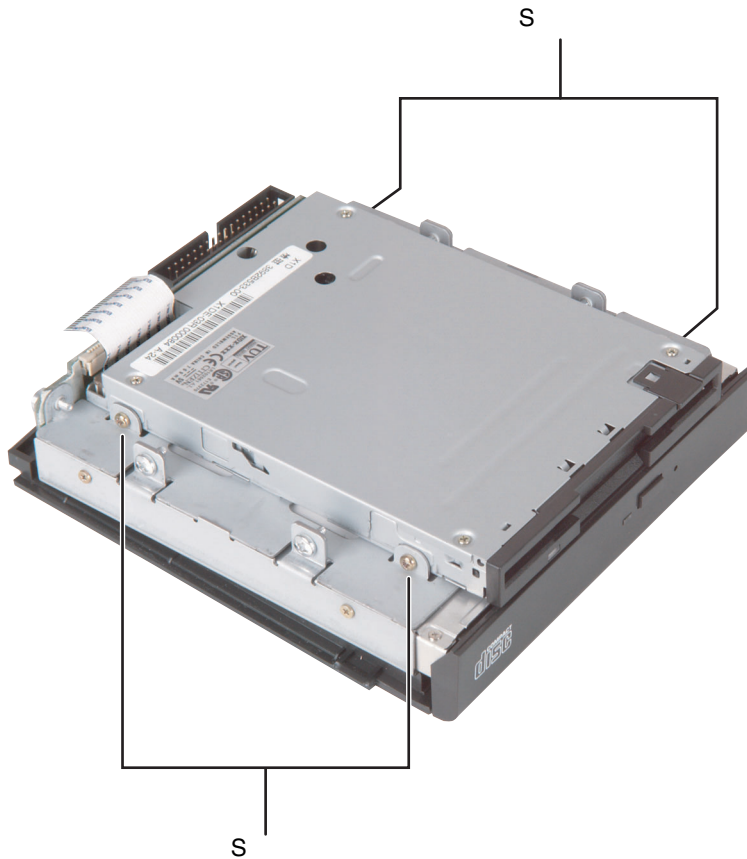

7 Remove the old diskette drive.

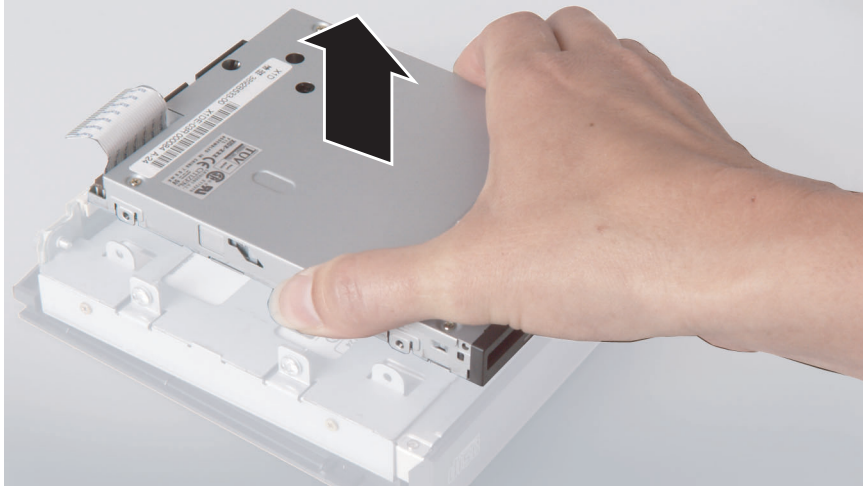

8 Insert the new diskette drive and secure it with the four screws removed in Step 6.

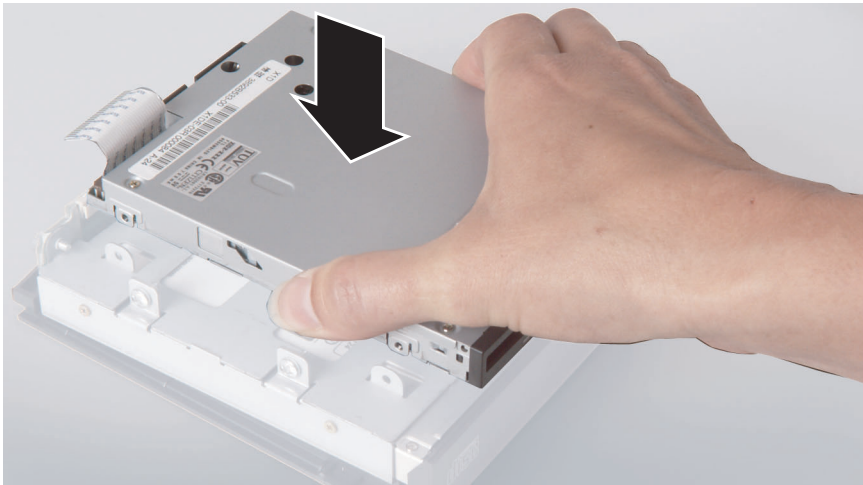

- 9** Connect the diskette drive cable, making sure that it is fully seated in the ZIF connector.



- 10** Connect the drive cables to the drive adapter card on the drive pack using the notes you made in Step 4. The drive cables and connectors are “keyed,” which means that they can only be plugged in one way.
- 11** Push the cables carefully up into the top of the drive bay.

- Align the tabs on the drive pack with the notches on the drive bay, then slide the drive pack back until it is flush with the front of the case.

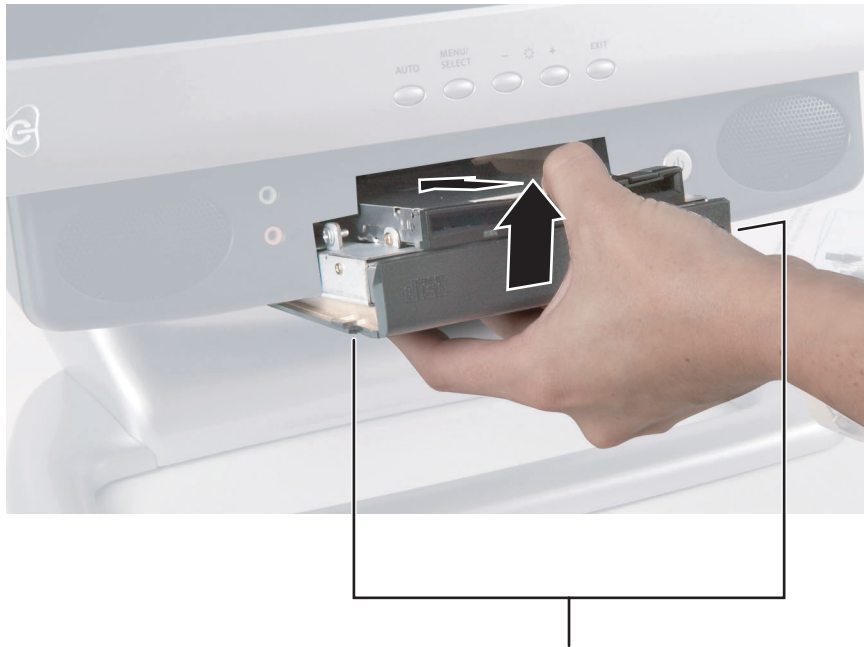

- Secure the drive pack with the two screws removed in Step 2.



Replacing the optical drive

The removable drive pack contains the diskette drive, drive adapter card, and an optical drive. The optical drive may be a CD, DVD, or recordable drive.

 **To replace the optical drive:**

- 1 Turn off the computer and prepare it by following the instructions in “Preparing your computer” on page 4.
- 2 Remove the two retaining screws located on either side of the Microsoft Certificate of Authenticity label on the back of your computer.

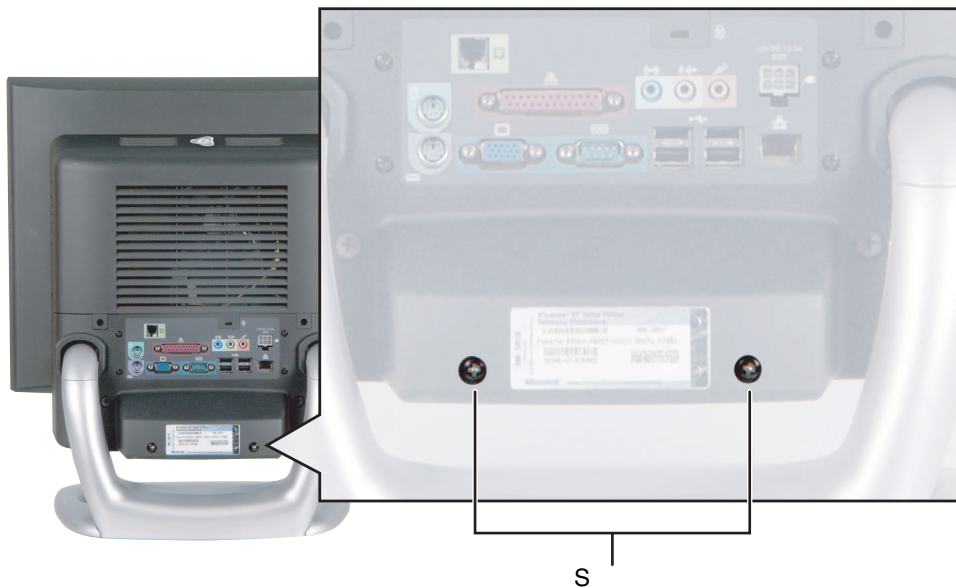

- 3 Slide the drive pack forward, then down.



- 4 Disconnect the two drive cables from the drive adapter card. Note the location and orientation of each cable. You will reconnect these cables later.

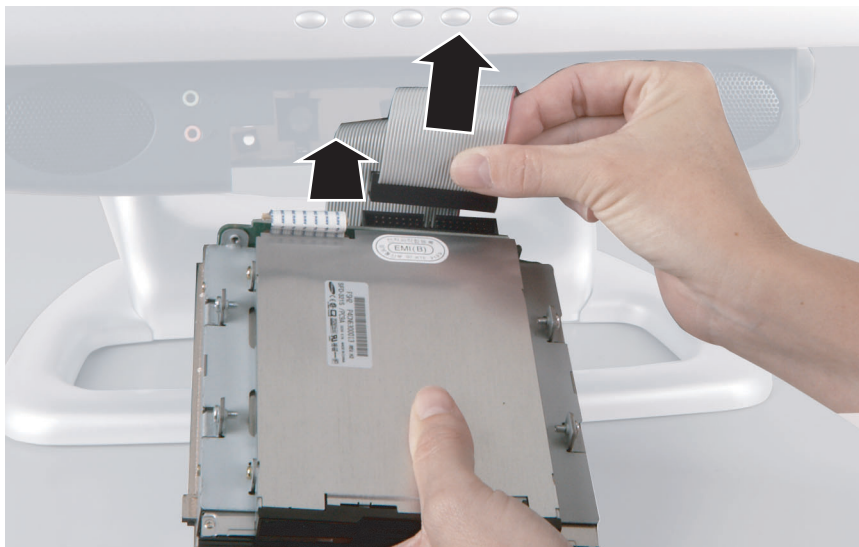

- 5 Remove the four screws that secure the optical drive to the drive pack.

Left Side



Right Side



- 6 Slide the optical drive out of the drive pack.



- 7 Slide in the new optical drive and secure it with the four screws removed in Step 5.



- 8 Connect the drive cables to the drive adapter card on the drive pack using the notes you made in Step 4. The drive cables and connectors are “keyed,” which means that they can only be plugged in one way.

- 9 Push the cables carefully up into the top of the drive bay.
- 10 Align the tabs on the drive pack with the notches on the drive bay, then slide the drive pack back until it is flush with the front of the case.

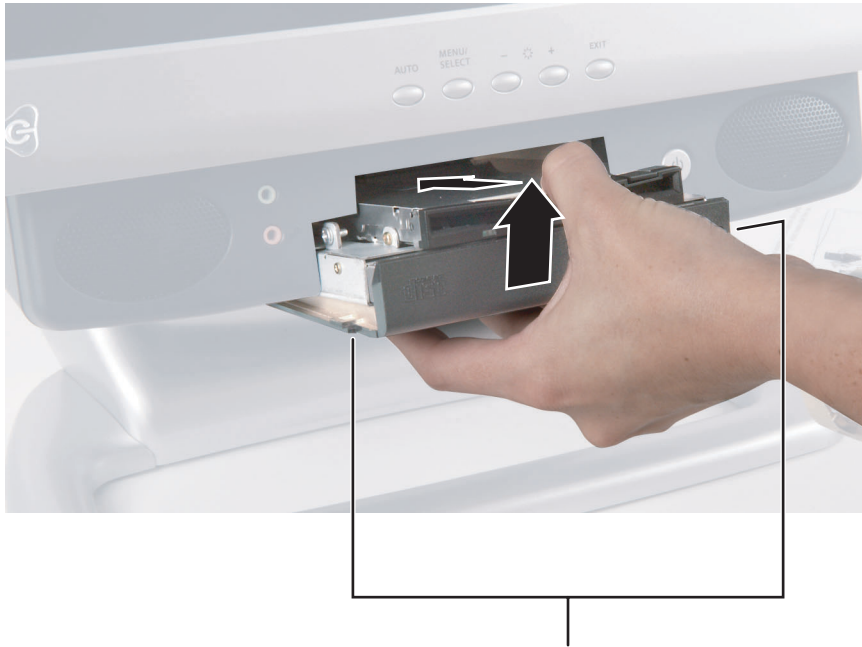

- 11 Secure the drive pack with the two screws removed in Step 2.



Replacing the hard drive

Use this procedure to replace the hard drive.

Tips & Tricks



F

. A

▶ To replace the hard drive:

- 1 Turn off the computer and prepare it by following the instructions in “Preparing your computer” on page 4.
- 2 Remove the two screws that secure the access panel to the back of the computer case.

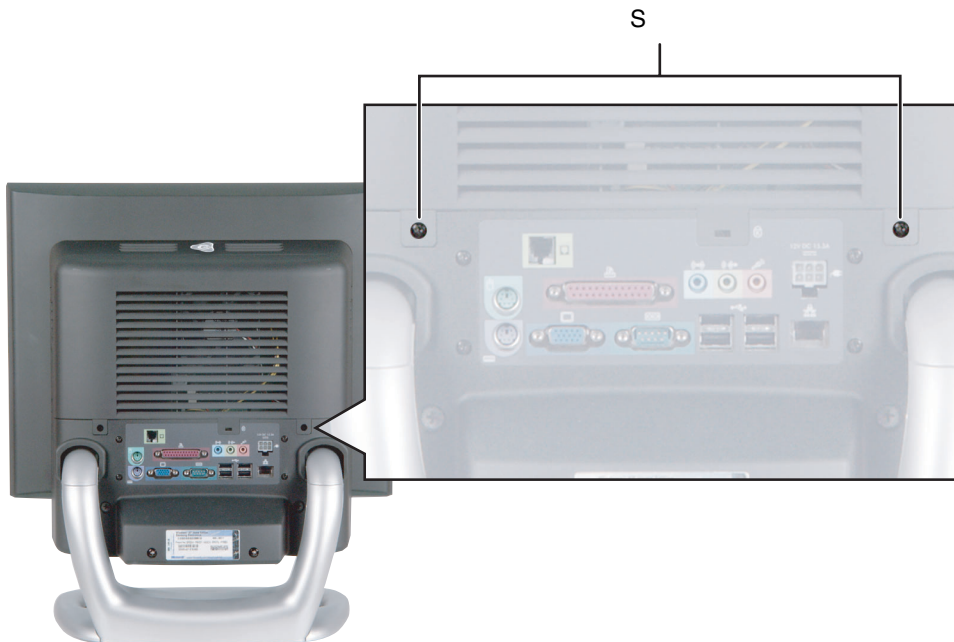

- 3 With your hands positioned on each side of the case, swing the access panel up and away from the case and set the access panel aside.

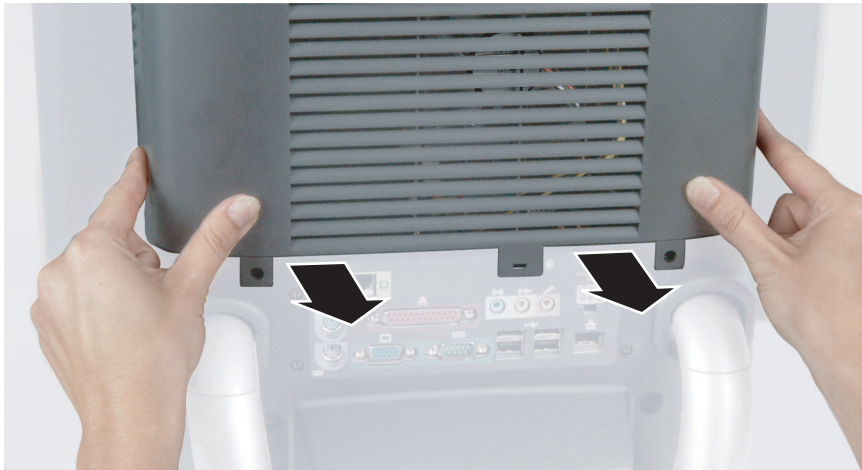

- 4 Unsnap the two hard drive cage tabs.



- 5 Remove the hard drive cage from your computer.

- 6 Disconnect the drive cable and power cable. Note the location and orientation of each cable. You will reconnect these cables later.

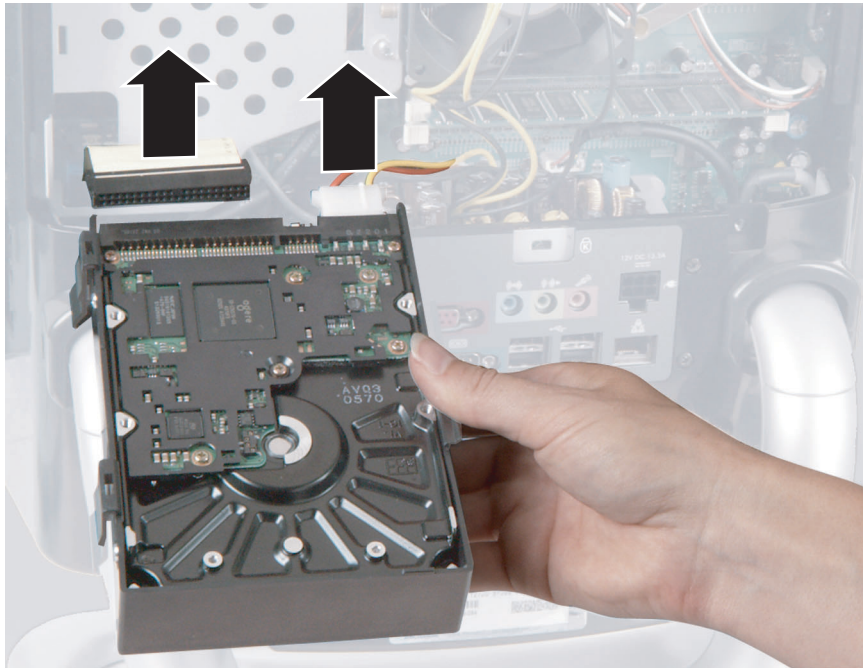

- 7 Remove the four screws that secure the drive to the hard drive cage.

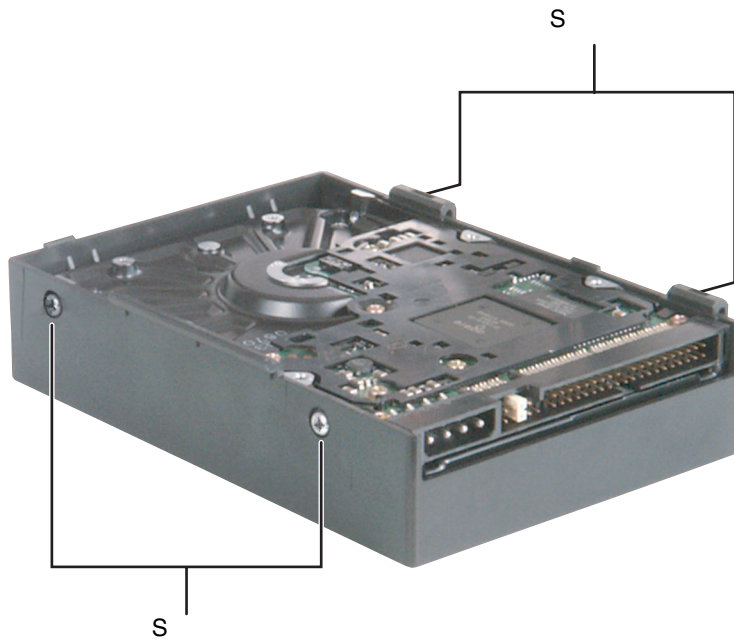

- 8 Remove the drive.

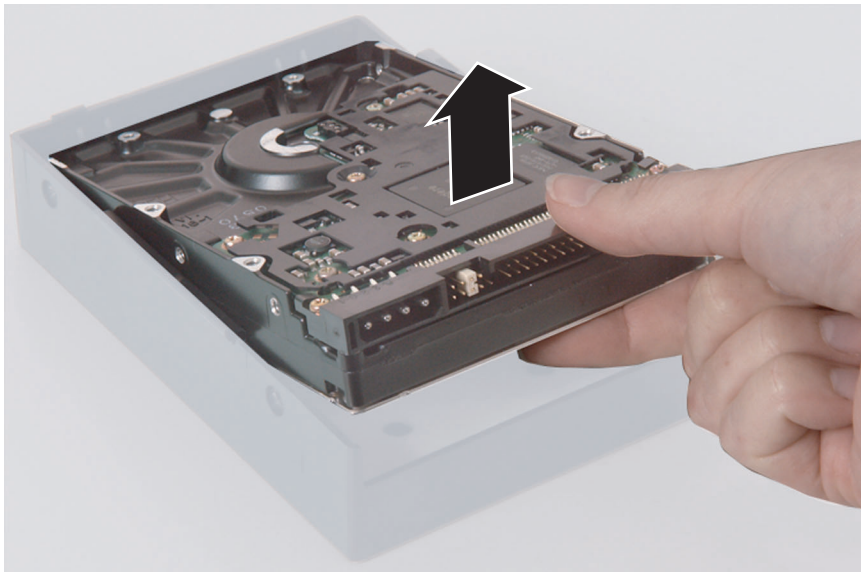

- 9 Make sure that the jumpers on the new drive are set the same as the jumpers on the drive you are replacing.

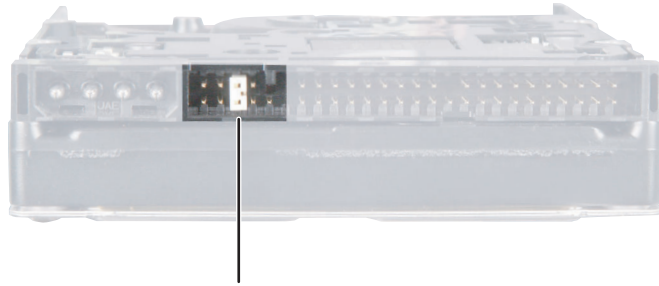

- 10 Insert the new drive into the hard drive cage and secure it with the four screws removed in Step 7.
- 11 Connect the drive cable and power cable to the drive using the notes you made in Step 6.
- 12 Align the single hard drive cage tab into the case notch, then swing the hard drive cage down until the two hard drive cage tabs on the other side snap into place.



- 13 Make sure that all of the internal cables are arranged inside the case so they will not be pinched when you close the case.
- 14 Align the access panel tabs into the case notches.

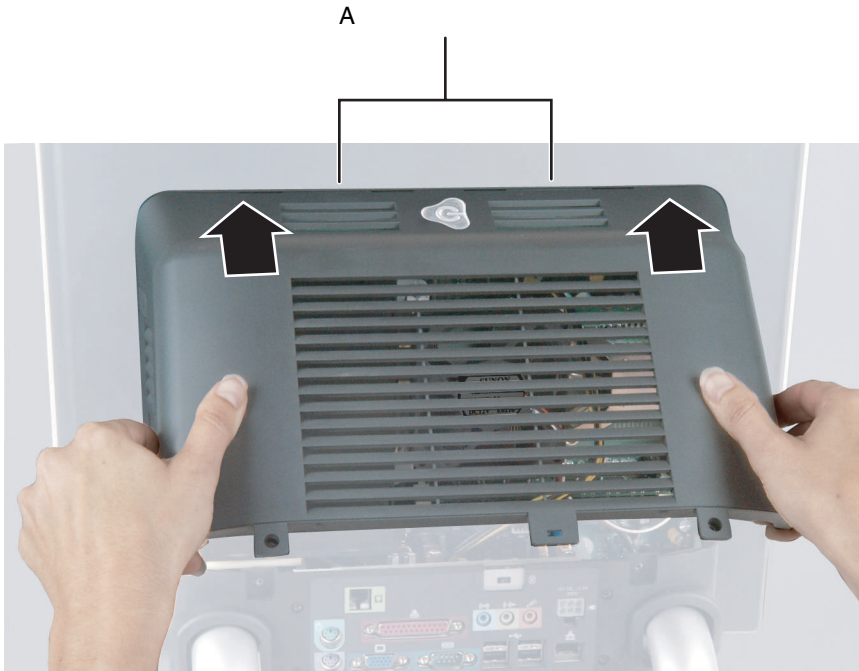

- 15 Swing the access panel down into place and secure it with the two screws removed in Step 2.



Replacing the Mini PCI card

If you need to install a new Mini PCI card, you must first remove the existing card.

Warning



R M PCI G

Tools you need to complete this task:



P

Tips & Tricks



F . A

To replace the Mini PCI card:

- 1 Turn off the computer and prepare it by following the instructions in “Preparing your computer” on page 4.
- 2 Remove the two screws that secure the access panel to the back of the computer case.

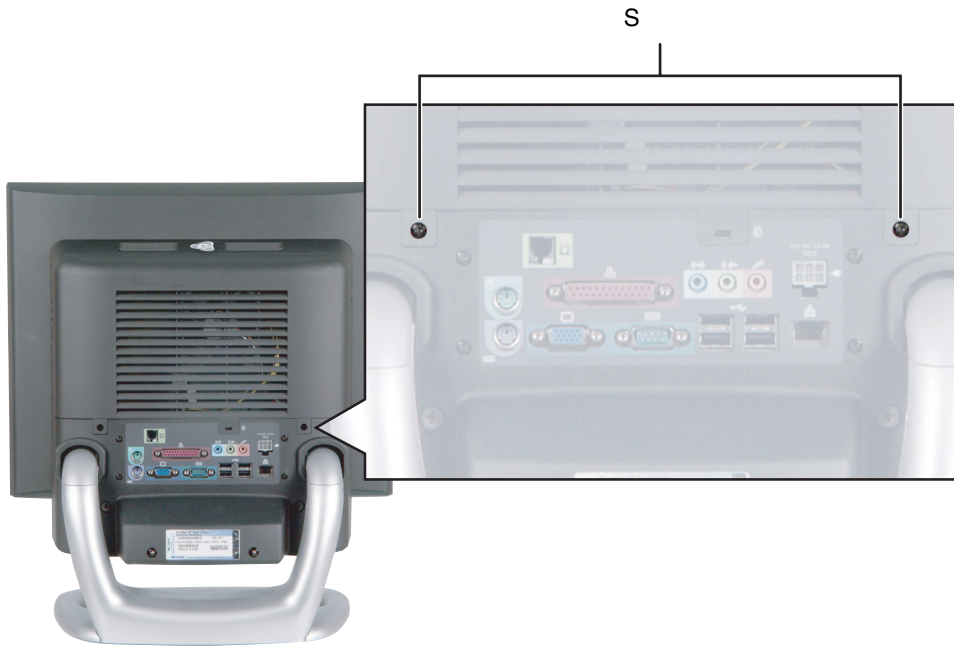

- 3 With your hands positioned on each side of the case, swing the access panel up and away from the case and set the access panel aside.

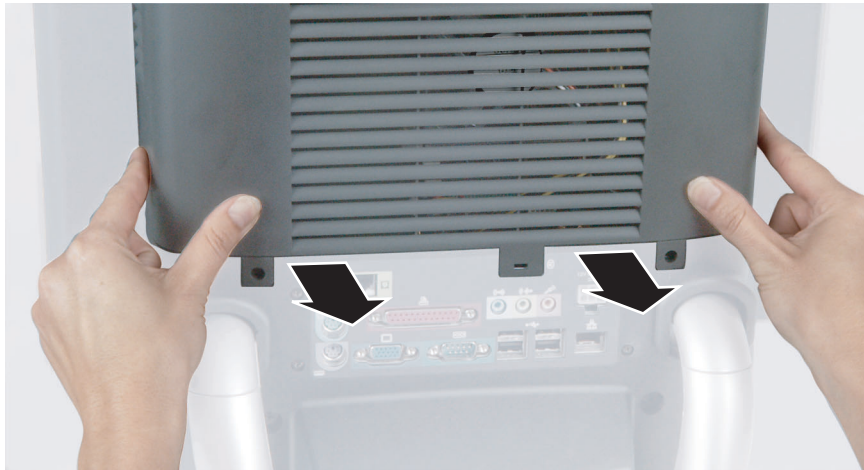

- 4 Unsnap the two hard drive cage tabs.



- 5 Remove the hard drive cage from your computer.
- 6 Disconnect the drive cable and power cable and set the drive cage aside. Note the location and orientation of each cable. You will reconnect these cables later.

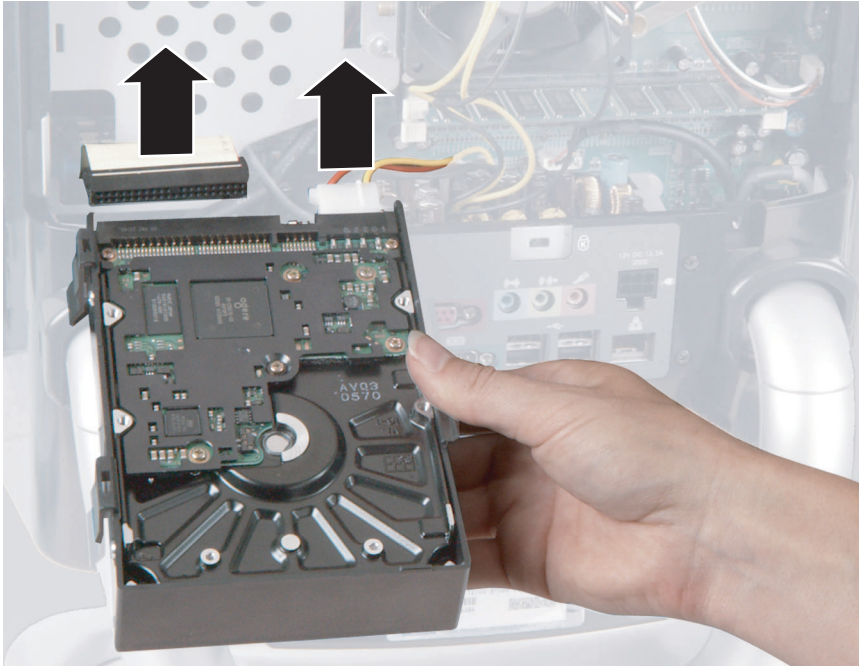

- 7 Remove the tape that secures the antenna cables to the Mini PCI wireless network card. (Shown with back case cover off, for clarity.)

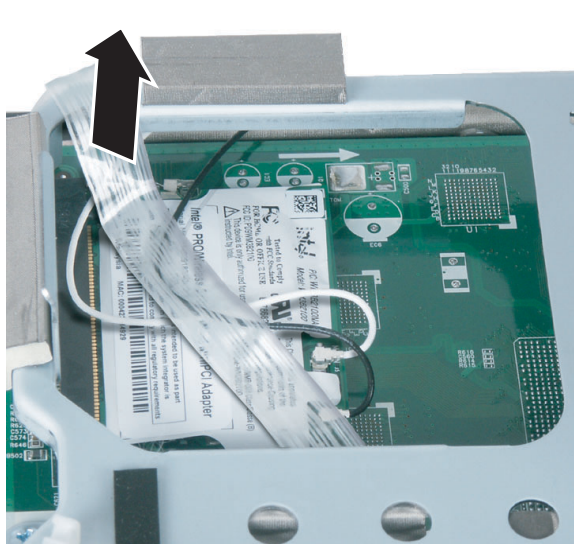

- 8 Disconnect the antenna cables from the network card.

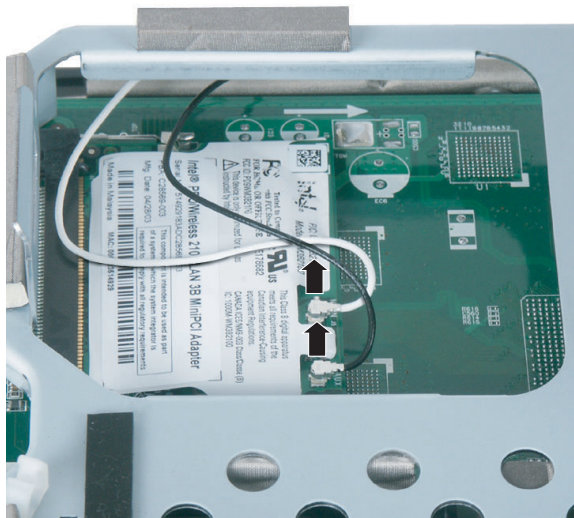

- 9 Press outward on both of the retaining clips holding the network card until the card tips up at an angle.



- 10 Remove the network card.

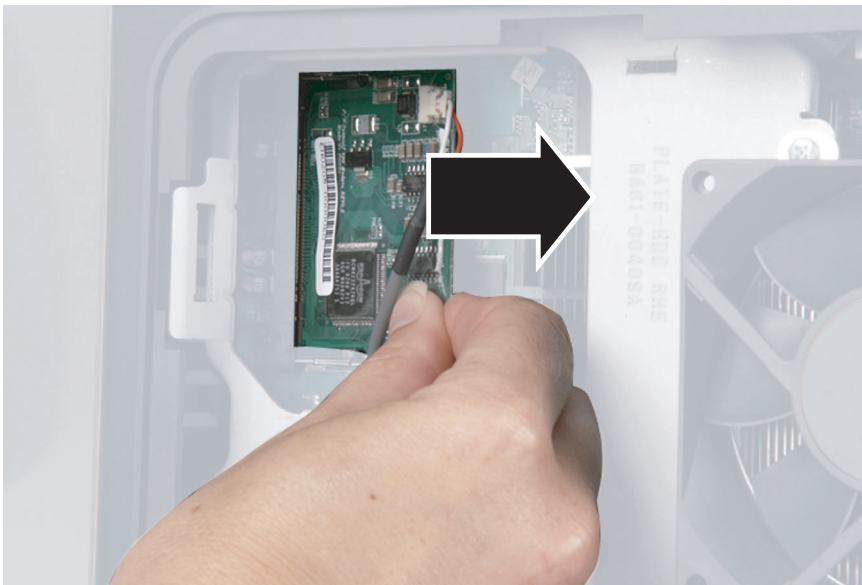

- 11 Carefully press the new network card into the card slot. The network card must be fully seated in the slot before the retaining clips will snap into place.

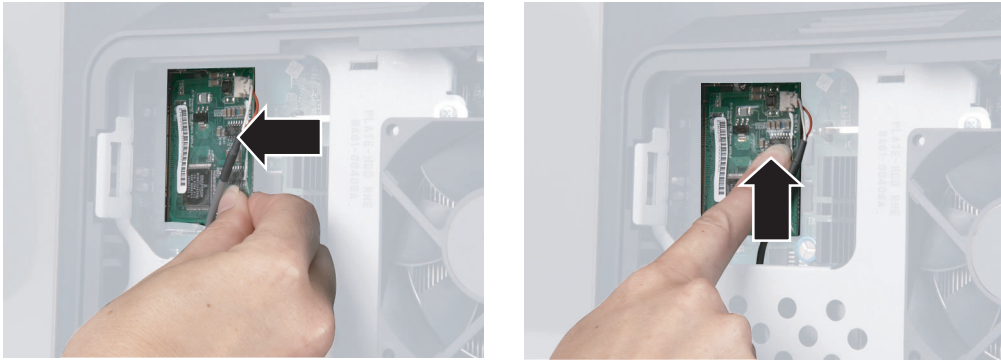

- 12 Plug the antenna cables back into the network card. The white wire connects to the post labeled **MAIN**, and the black wire connects to the post labeled **AUX**.
- 13 Secure the wires to the network card by reapplying the tape you removed in Step 7.
- 14 Connect the drive cable and power cable to the hard drive using the notes you made in Step 6.

- 15** Align the single hard drive cage tab into the case notch, then swing the hard drive cage down until the two hard drive cage tabs on the other side snap into place.



- 16** Make sure that all of the internal cables are arranged inside the case so they will not be pinched when you close the case.

- 17** Align the access panel tabs into the case notches.

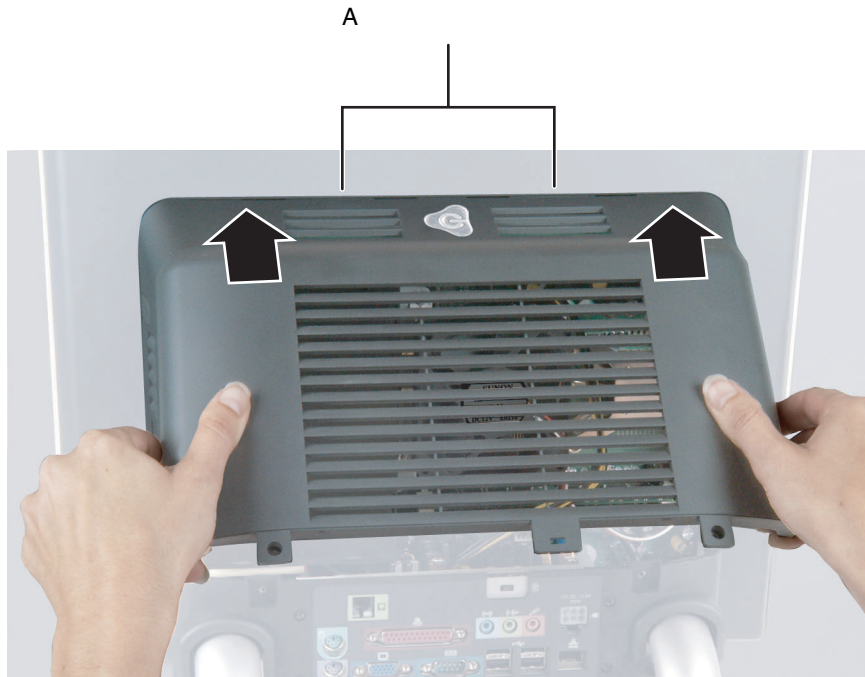

- 18** Swing the access panel down into place and secure it with the two screws removed in Step 2.



Installing or replacing DIMM memory

Important



U DDR DIMM .

Tools you need to complete this task:



P

Tips & Tricks



F . A

▶ To install or replace DIMM memory:

- 1** Turn off the computer and prepare it by following the instructions in “Preparing your computer” on page 4.
- 2** Remove the two screws that secure the access panel to the back of the computer case.

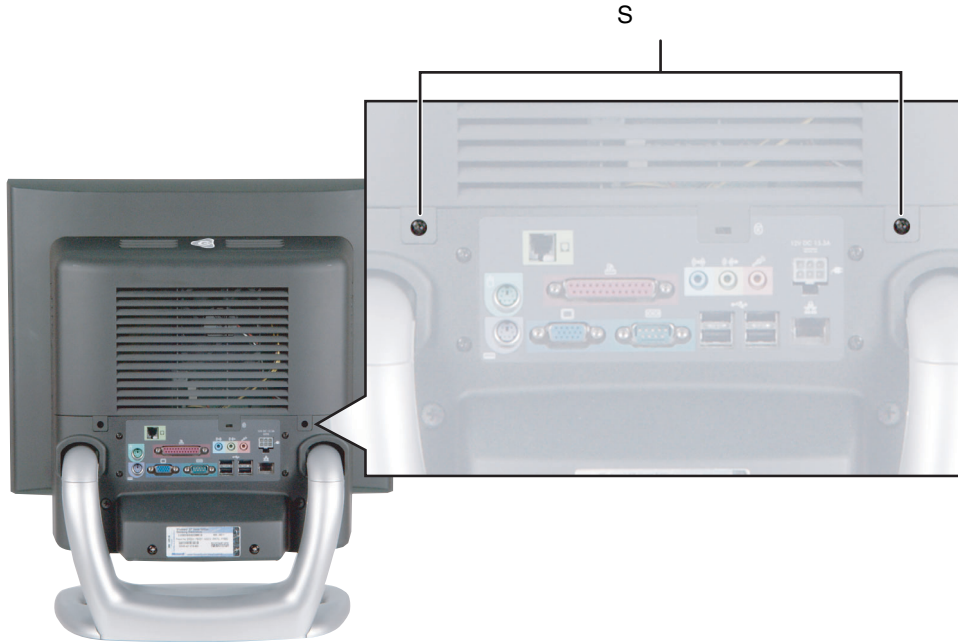

- 3 With your hands positioned on each side of the case, swing the access panel up and away from the case and set the access panel aside.

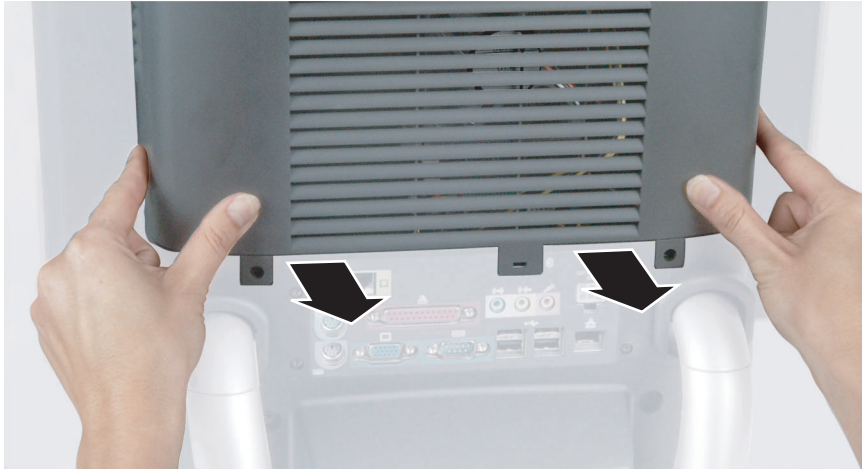

- 4 Find the memory module banks, sometimes called add-in slots, on your system board.

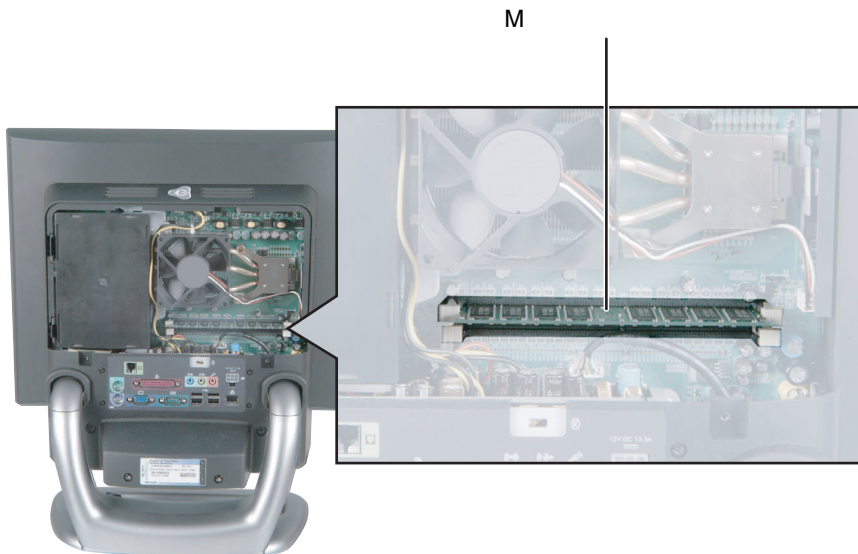

- 5 If you are removing a memory module from the memory module bank, gently pull the plastic tabs away from the sides of the memory module and remove it.

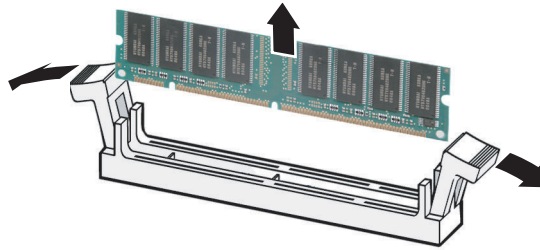

- OR -

If you are adding a memory module to an empty memory module bank, gently pull the plastic tabs away from the sides of the memory module bank.

- 6 Align the notch on the new memory module with the notch on the memory module bank and press firmly into the bank. The tabs on the sides of the memory module should secure the memory module automatically. When the module locks into place, you hear a click.

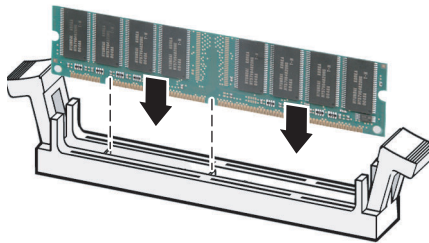

- 7 Make sure that all of the internal cables are arranged inside the case so they will not be pinched when you close the case.

- 8 Align the access panel tabs into the case notches.

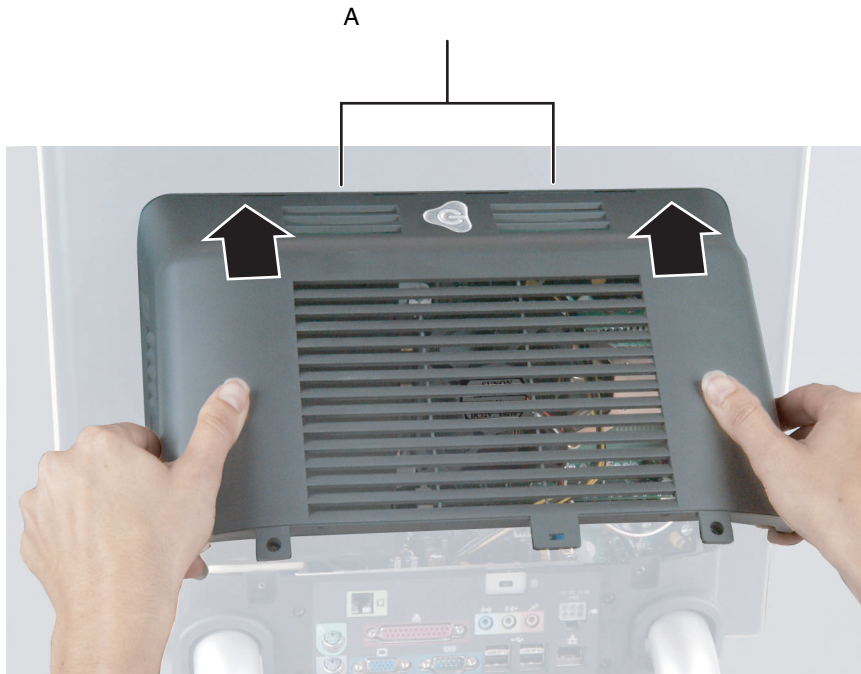

- 9 Swing the access panel down into place and secure it with the two screws removed in Step 2.
- 10 Reconnect the external cables and power cord.
- 11 Turn on your computer. Windows starts and the Windows desktop appears.
- 12 In Windows XP, click **Start**, **Control Panel**, then click **Performance and Maintenance** (if in Category View). Click/Double-click **System**. The amount of memory in your computer is shown at the bottom of the *System Properties* window in the General tab.

- OR -

In Windows 2000, right-click the **My Computer** icon, then click **Properties**. The amount of memory in your computer is shown at the bottom of the *System Properties* window in the General tab.



Replacing the fan

Tools you need to complete this task:



Tips & Tricks



F

. A

 **To replace the fan:**

- 1 Turn off the computer and prepare it by following the instructions in “Preparing your computer” on page 4.
- 2 Remove the two screws that secure the access panel to the back of the computer case.

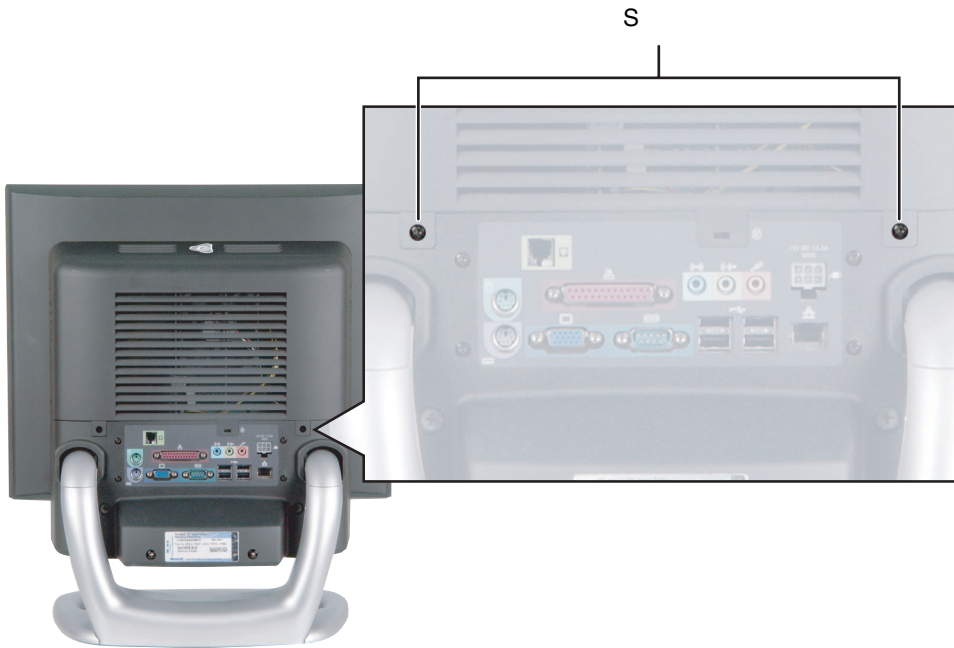

- 3 With your hands positioned on each side of the case, swing the access panel up and away from the case and set the access panel aside.

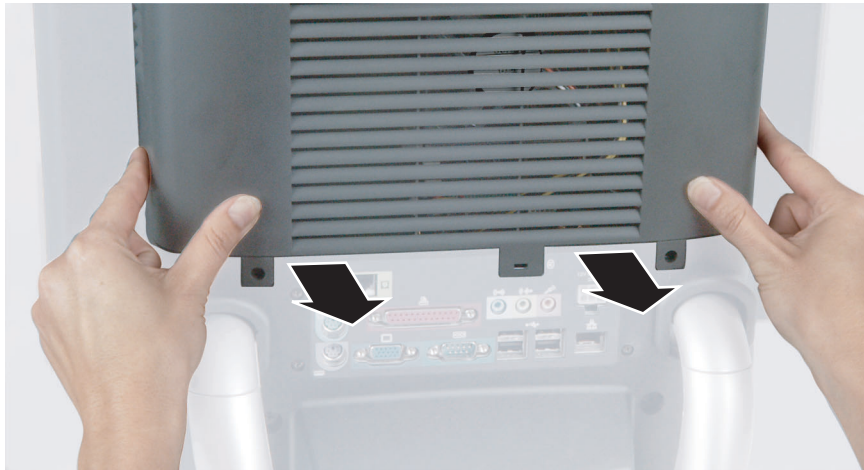

- 4 Remove the four screws that secure the fan to the heatsink.

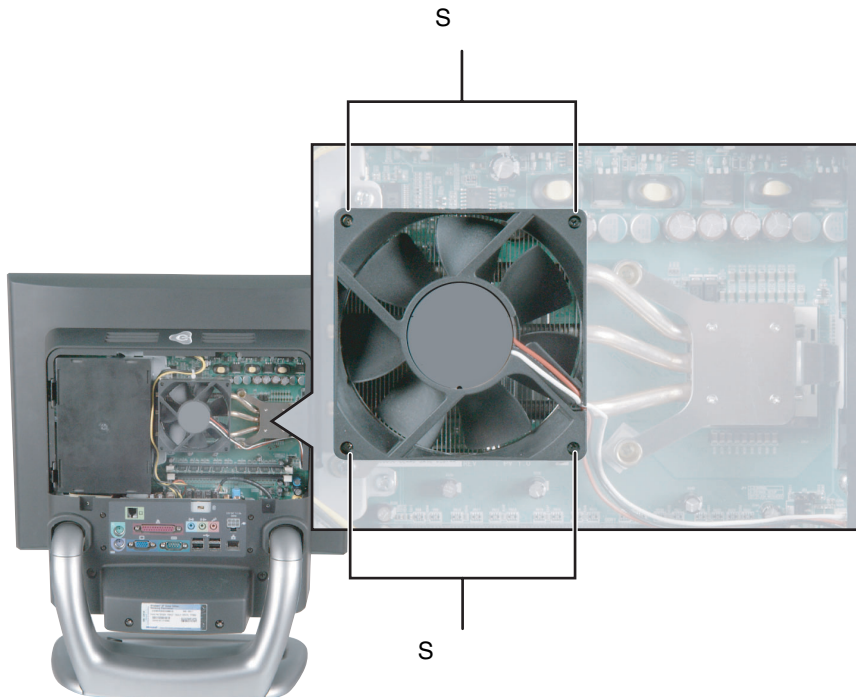

- 5** Disconnect the fan power cable. Note the location and orientation of the cable. You will reconnect this cable later.

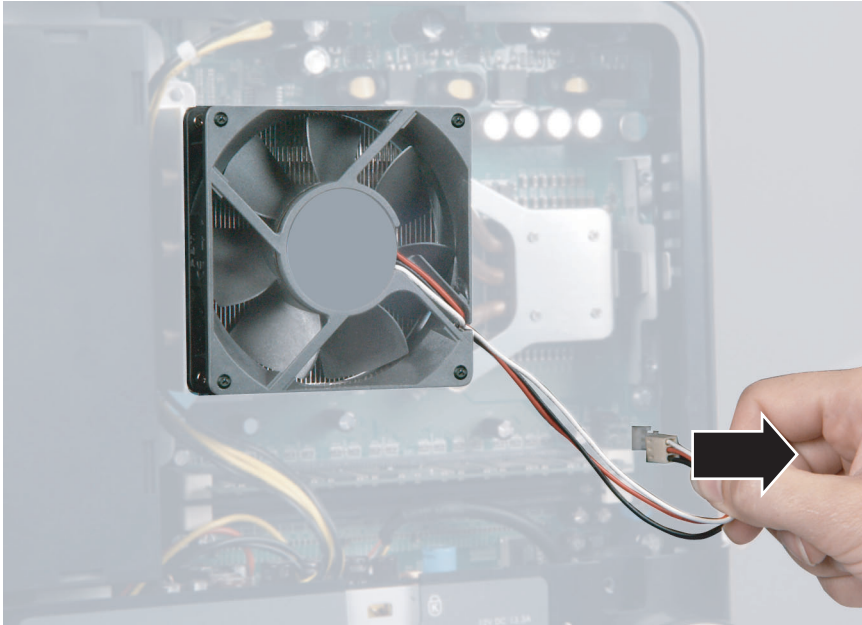

6 Remove the old fan.

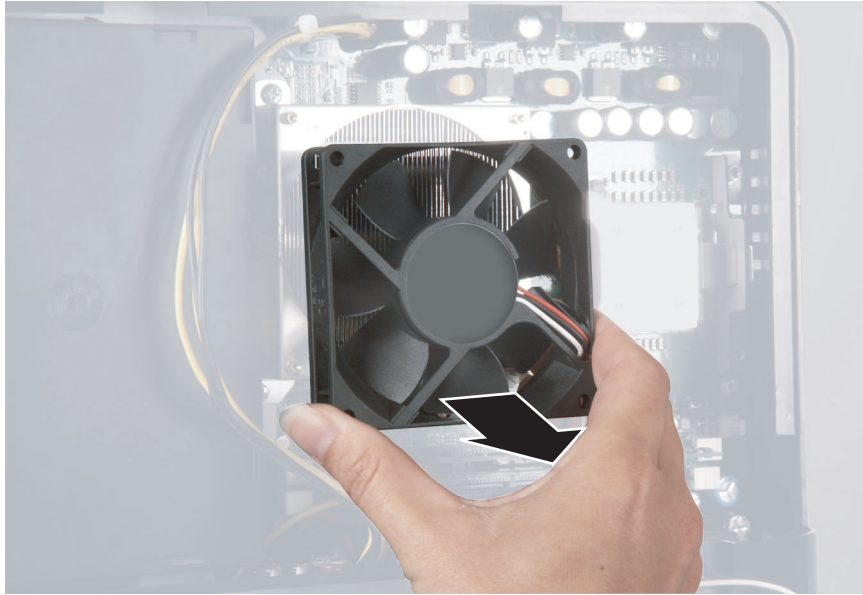

7 Secure the new fan to the heatsink with the four screws removed in Step 4.

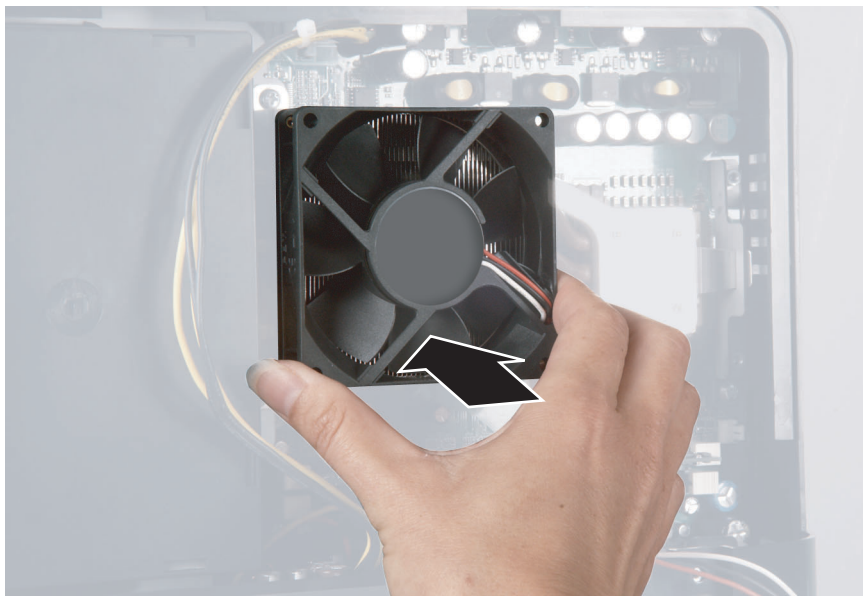

- 8 Connect the fan power cable using the notes you made in Step 5.
- 9 Make sure that all of the internal cables are arranged inside the case so they will not be pinched when you close the case.
- 10 Align the access panel tabs into the case notches.

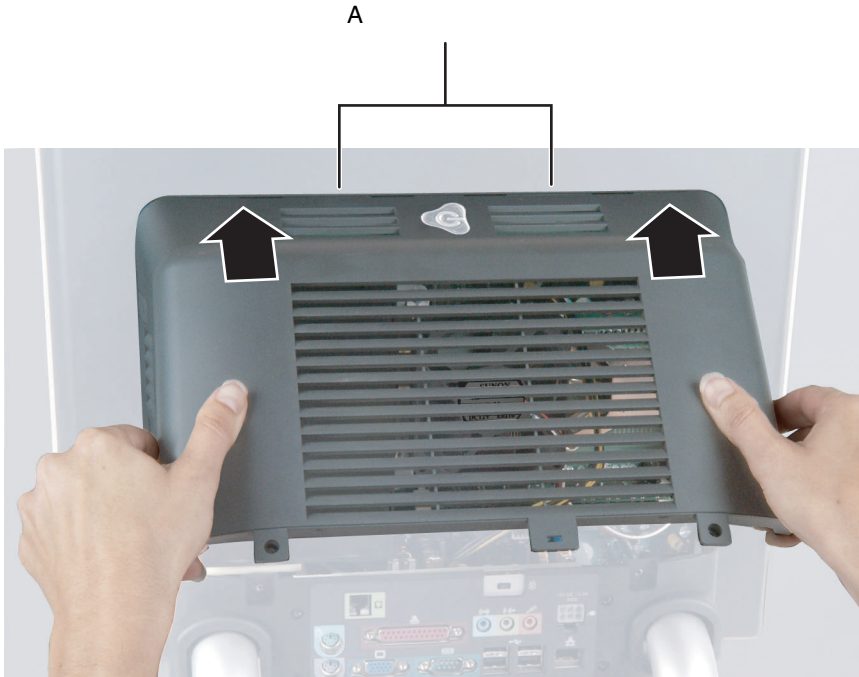

- 11 Swing the access panel down into place and secure it with the two screws removed in Step 2.



Replacing the LCD panel inverter board

Tools you need to complete this task:



 To replace the LCD panel inverter board:

- 1 Turn off the computer and prepare it by following the instructions in “Preparing your computer” on page 4.
- 2 Lay the computer down on its back.

- 3 Starting at the bottom center of the LCD panel bezel, carefully work your fingers under the plastic to pry the bezel away from the LCD panel. Work your fingers between the LCD glass and the bezel, not underneath the outside of the bezel.
- 4 Continue to work your fingers around each side of the screen while carefully prying the plastic tabs on the bezel away from the LCD panel.

Warning



A

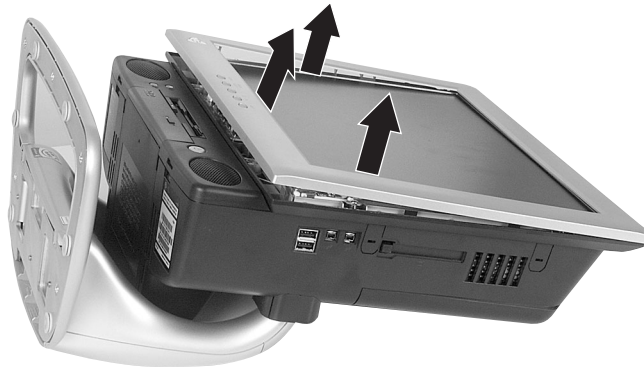

- 5 Remove the four screws that hold the LCD panel to the case.

Warning



LCD

LCD

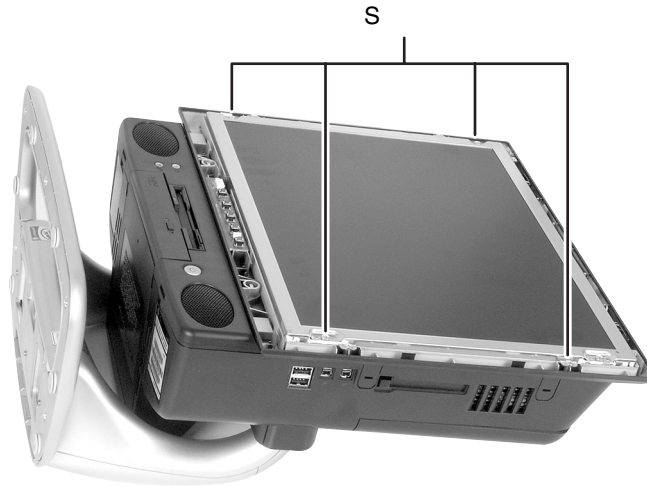

- 6 Carefully tilt the bottom of the LCD panel slightly away from the case to access the cables behind the panel.

- 7 Unplug the cable from the side of the inverter board closest to you (nearest the “open” side of the tilted LCD panel).

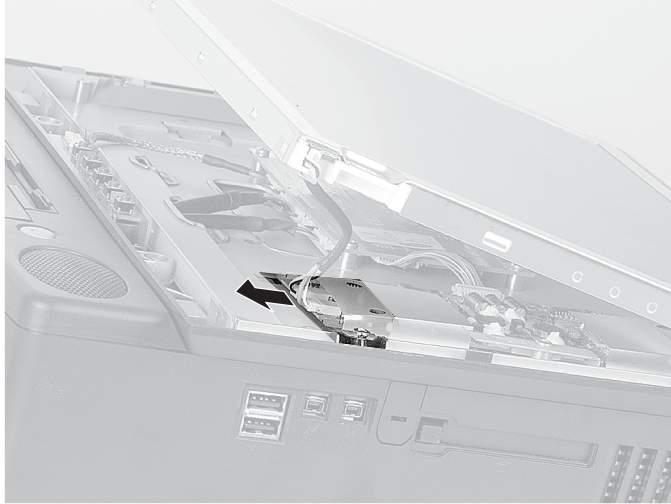

- 8 Tilt the LCD panel up further and unplug the other cable from the inverter board, then unplug the scaler board connector from the LCD panel.

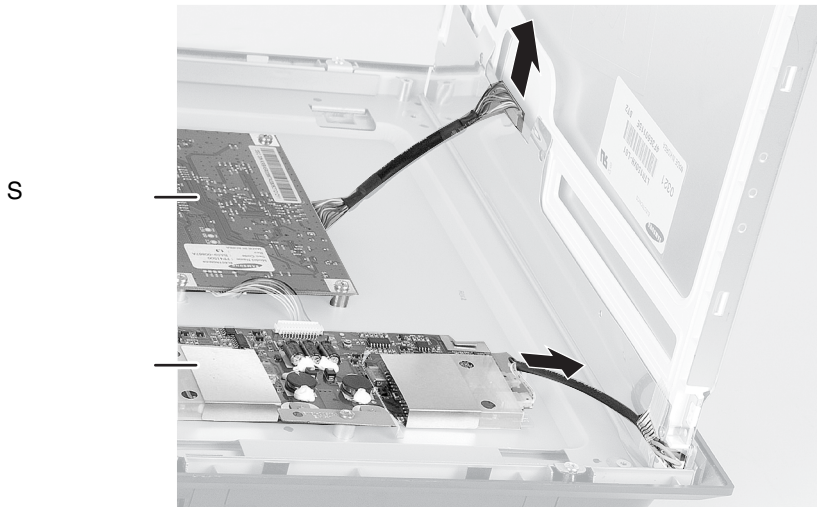

- 9 Remove the LCD panel from the computer and set it aside.

- 10 Unplug the cable that connects the inverter board to the scaler board, then remove the mounting screw on the inverter board.

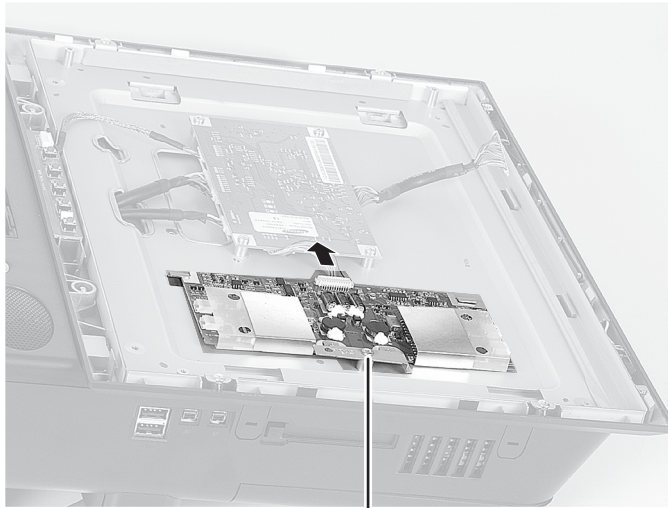

S

- 11 Remove the inverter board from the computer.

Tips & Tricks

M

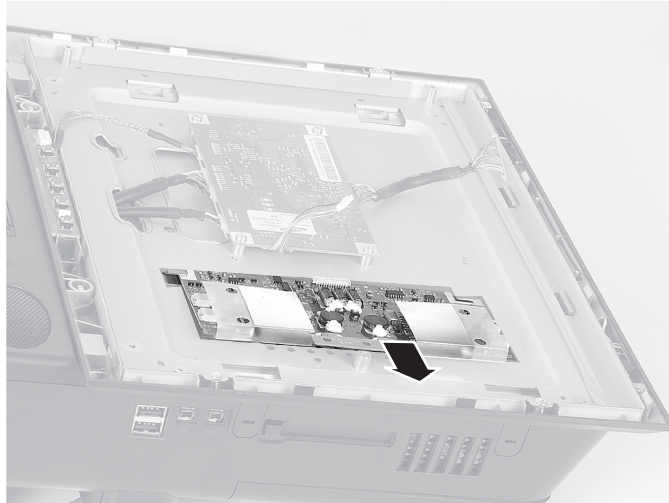

- 12 Hold the new inverter board by its edges, then align the mounting holes with the standoffs and attach the screw to the new board.

Warning

D



- 13 Place the LCD panel back onto the computer.
- 14 Reattach the scaler board cable to the LCD panel.
- 15 On the side of the inverter board closest to the top of the LCD panel, connect:
 - The blue and black cable to the connector labeled CN4.
 - The pink and white cable to the connector labeled CN5.

- 16** On the side of the inverter board closest to the bottom of the LCD panel, connect:
- The pink and white cable to the connector labeled CN2.
 - The blue and black cable to the connector labeled CN3.

Warning



- 17** Press the LCD panel into place, and make sure that all cables are safely inside the computer behind the LCD panel. If you have difficulty pressing the LCD panel back into place, first press the top of the panel into place, then press the bottom forward and down.
- 18** Attach the LCD panel with the four screws, then set the computer upright.
- 19** Plug in the power cord, then turn on the computer to make sure that the display has been repaired. If the display appears to be working, turn off the computer and lay the computer down on its back again.

- 20** Align the plastic bezel's tabs with the tab slots on the computer, then firmly press the bezel into place. Make sure all four edges are correctly attached and that the bezel has a tight fit.



Replacing the system board

Tools you need to complete this task:



 To replace the system board:

- 1 Turn off the computer and prepare it by following the instructions in “Preparing your computer” on page 4.
- 2 Remove the two retaining screws located on either side of the Microsoft Certificate of Authenticity label on the back of your computer.

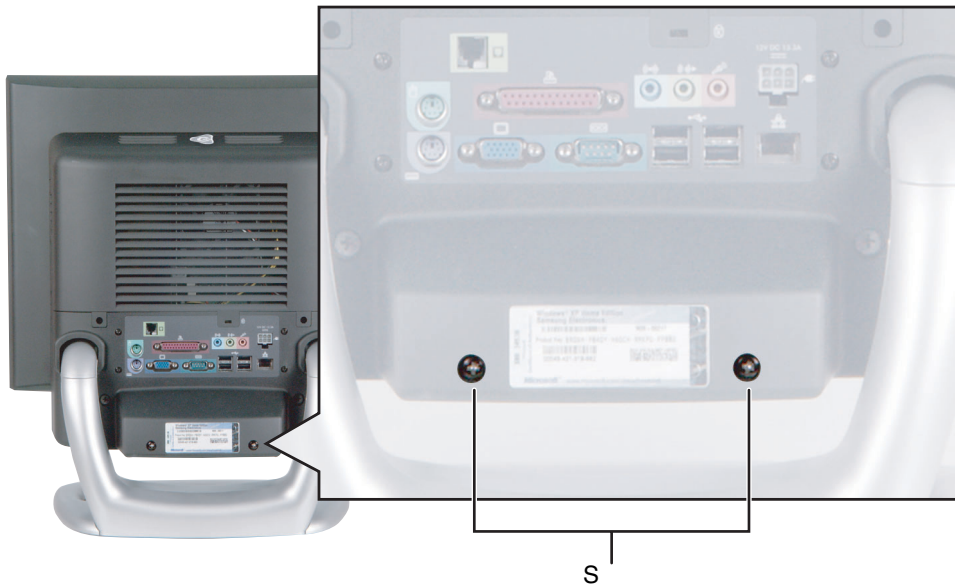

- 3 Slide the drive pack forward, then down.



- 4 Disconnect the two drive cables from the drive adapter card and set the drive pack aside. Note the location and orientation of each cable. You will reconnect these cables later.

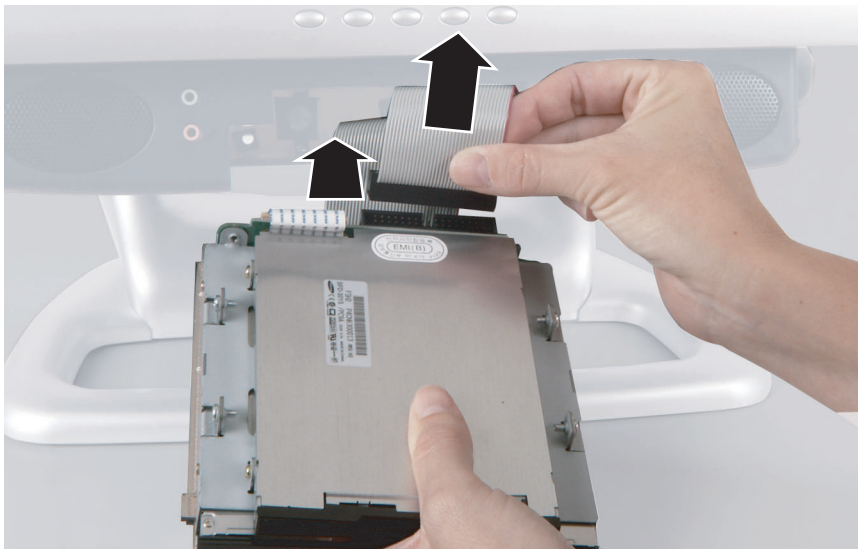

- 5 Remove the two screws that secure the access panel to the back of the computer case.

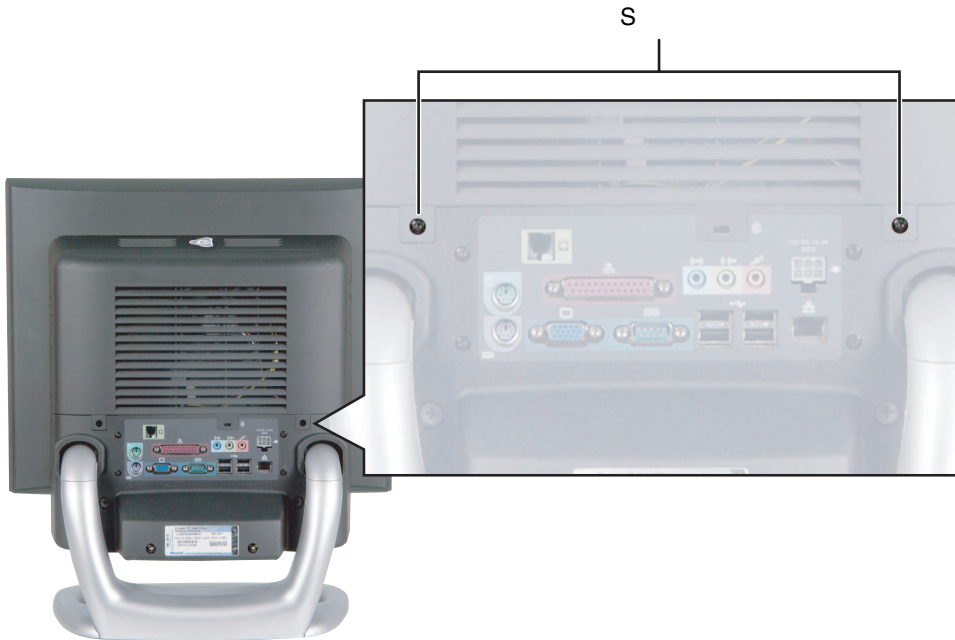

- 6 With your hands positioned on each side of the case, swing the access panel up and away from the case and set the access panel aside.



- 7 Unsnap the two hard drive cage tabs.



- 8 Remove the hard drive cage from your computer.

- 9 Disconnect the drive cable and power cable. Note the location and orientation of each cable. You will reconnect these cables later.

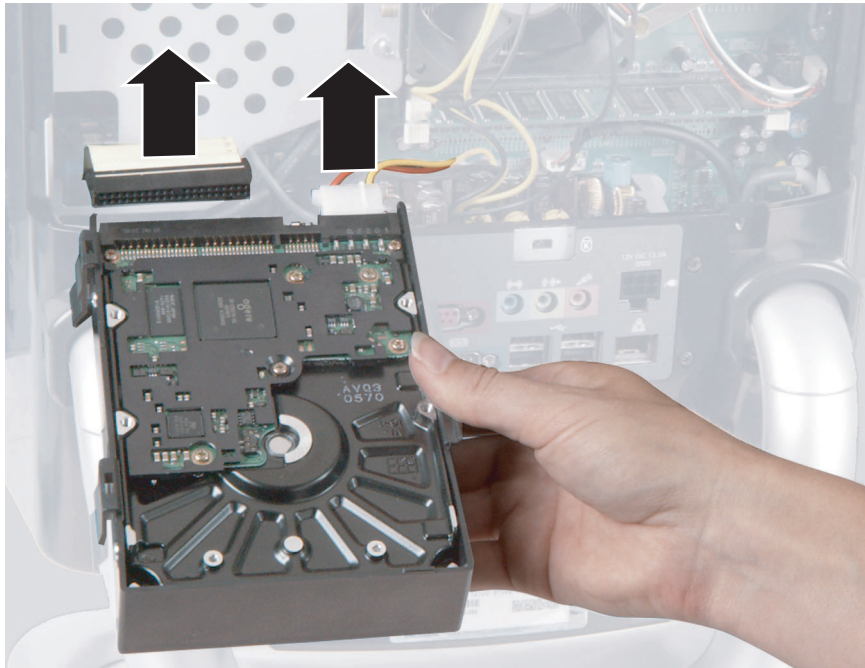

- 10 Press the PC Card eject button so the eject button is extended.

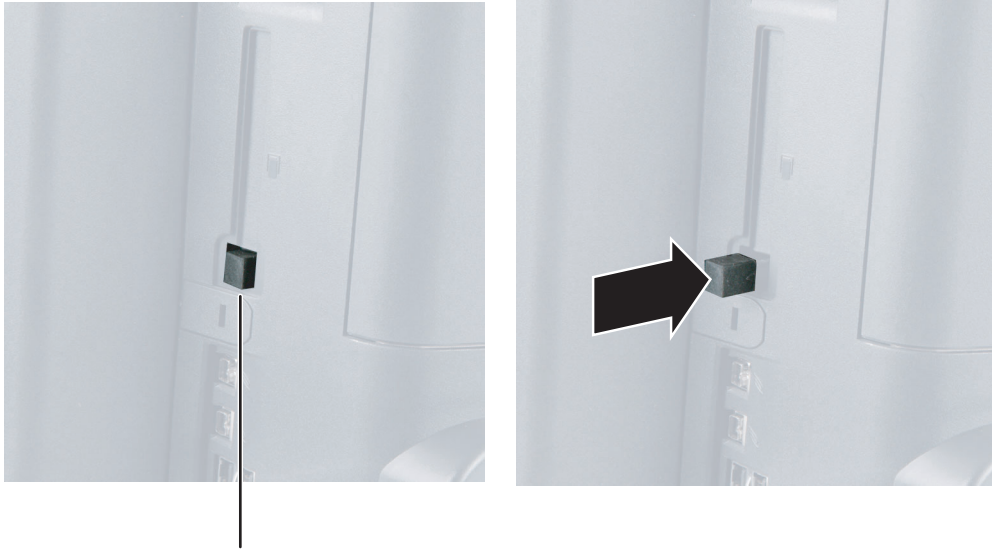

PC C

- 11 Pull off the rubber eject button cover, then push the PC Card eject button back in so it is flush with the system case.
- 12 Remove the tape that secures the antenna cables to the network card.

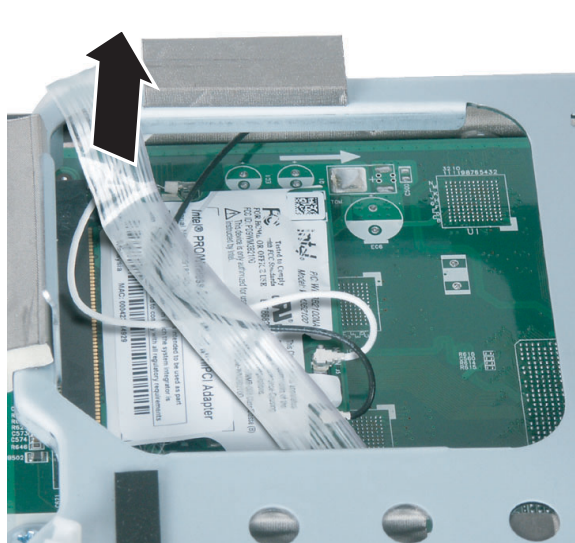

- 13 Disconnect the antenna cables from the network card.

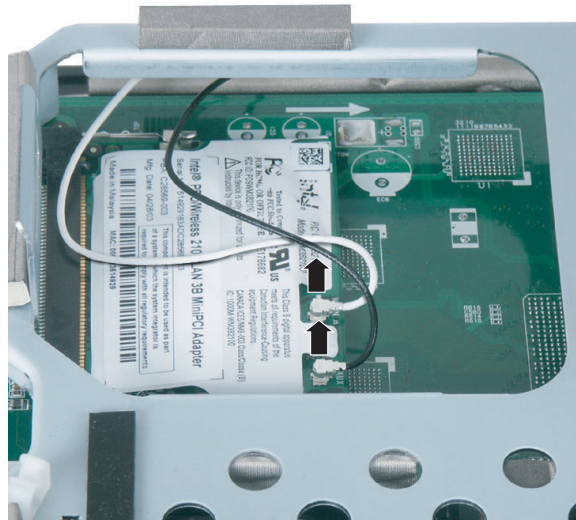

- 14 Disconnect the fan power cable. Note the location and orientation of the cable. You will reconnect this cable later.

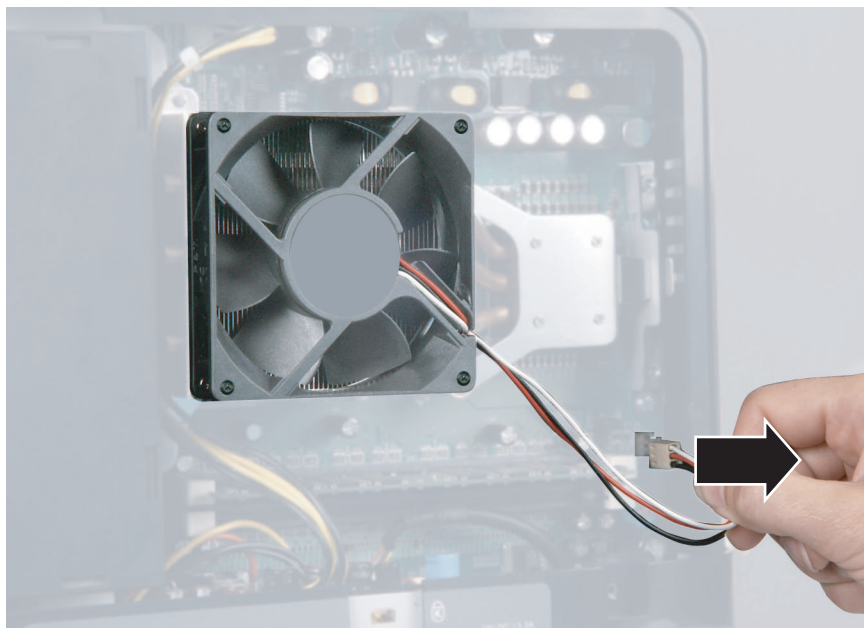

15 Remove the four heatsink screws.

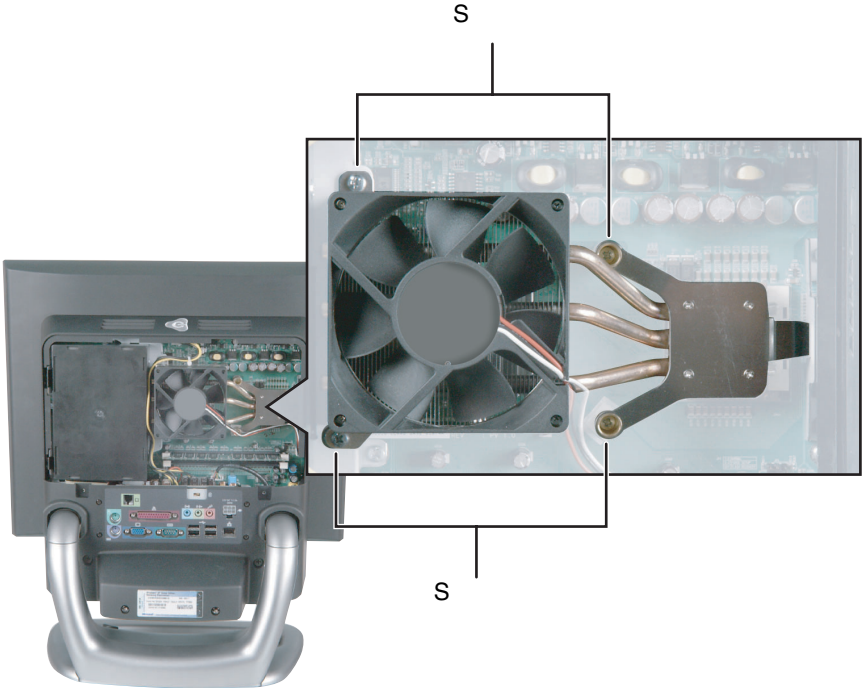

- 16** Gently move the heat sink side to side to make sure that the seal on the processor is loosened, then swing the heatsink up and away from the computer.

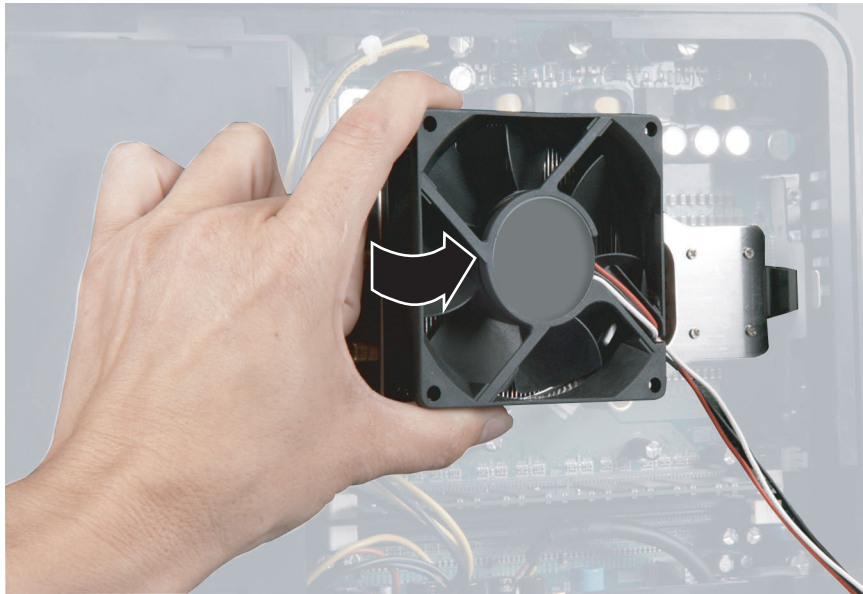

17 Remove the six back case cover screws.

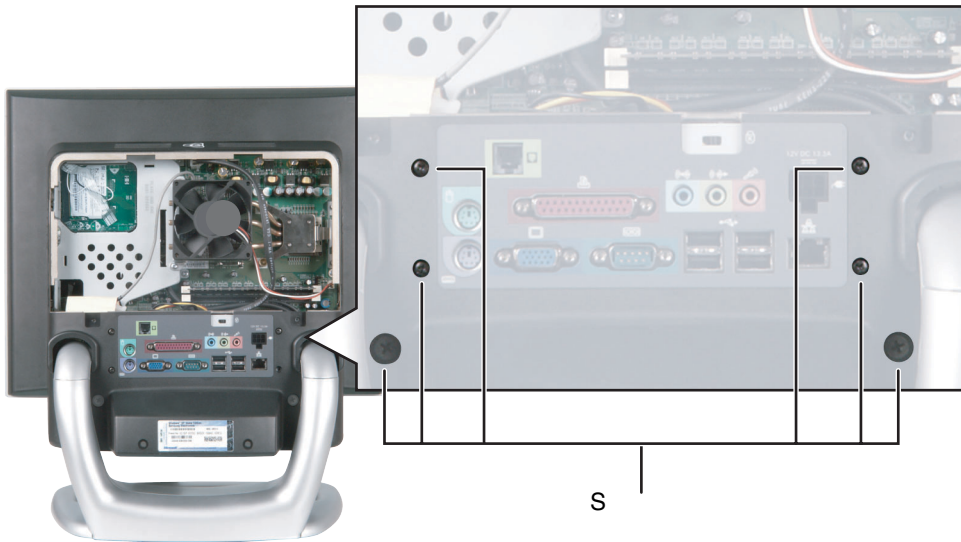

18 Place your computer face down. Avoid scratching the computer display by placing it on a towel or other non-abrasive surface.

- 19** Use a flat-blade screwdriver to push out the four side screw caps from inside the case, then use the screwdriver to remove the screw caps (two on each side of the case).

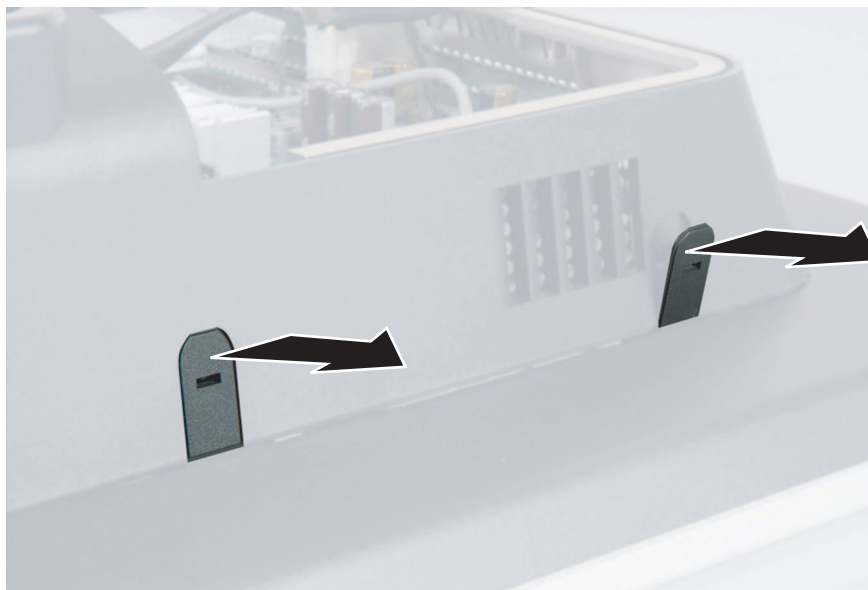
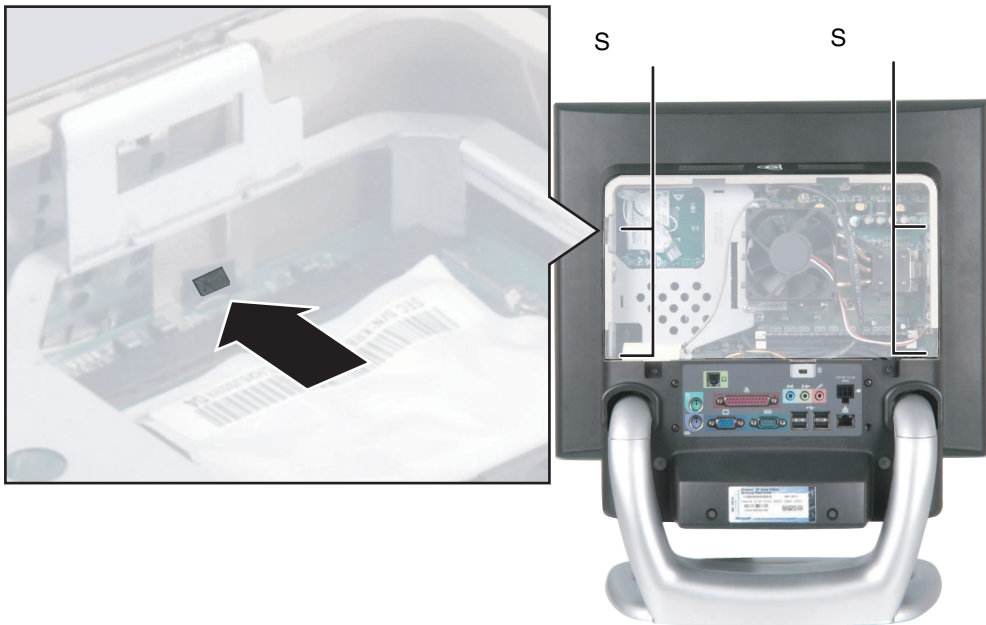

- 20** Use a Philips screwdriver to remove the four case cover side screws (two on each side of the case).

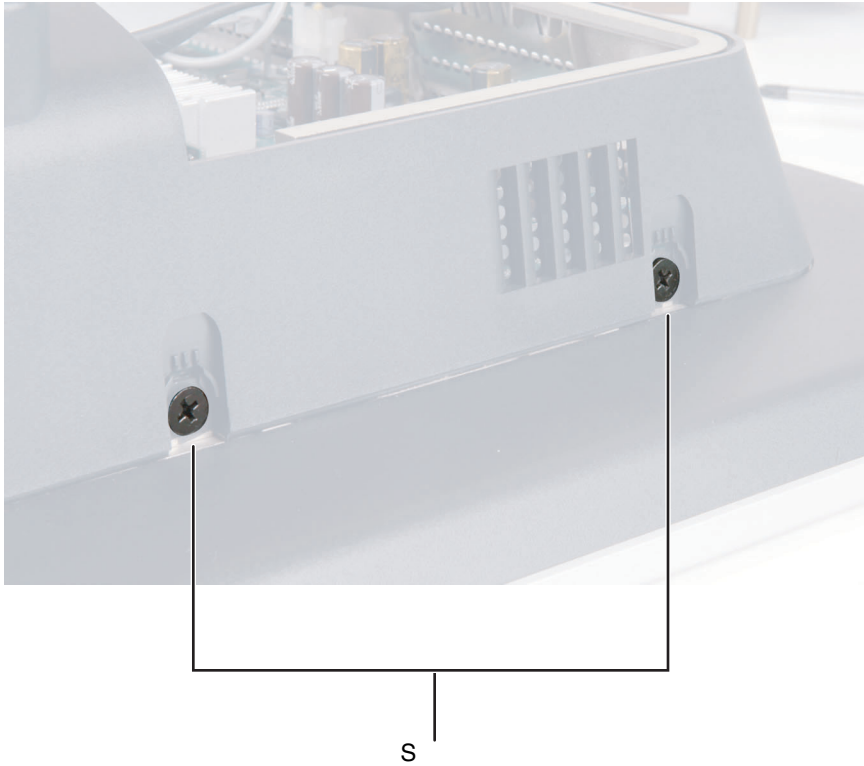

- 21** Push up slightly on the stand so you can release the two case retaining tabs on the bottom of the computer.

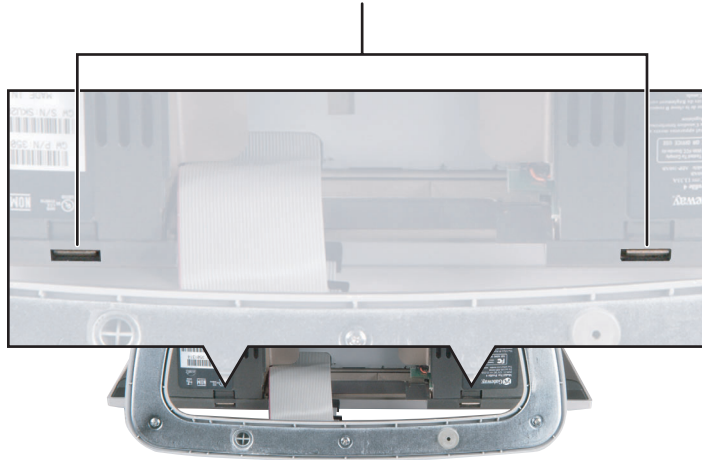

- 22** Press in on the case cover to release the case retaining tabs.

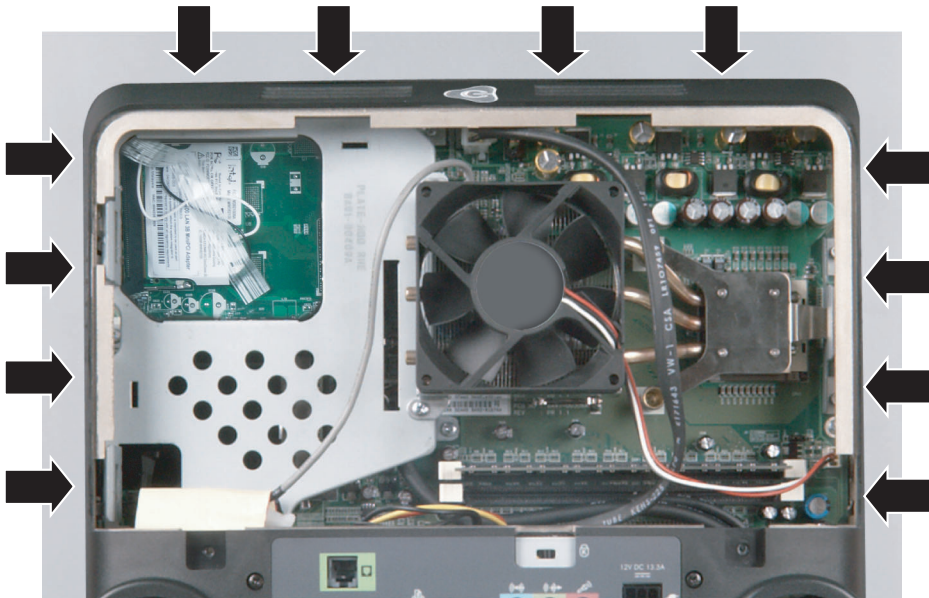

23 Lift the case cover straight up, then set it aside.

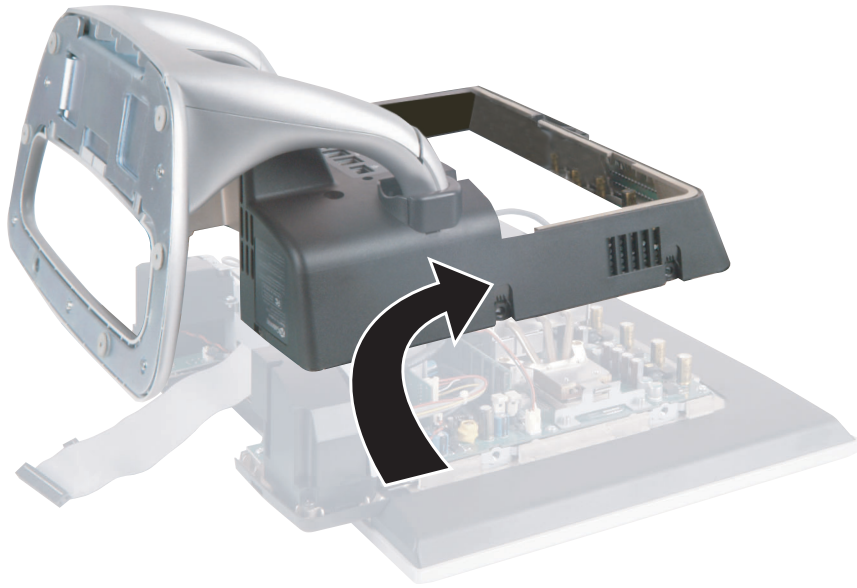

- 24** Disconnect the hard drive, power, and LED cables from the system board. Disconnect the speaker and headphone/microphone jack cables from the audio card. Note the location and orientation of each cable. You will reconnect these cables later.

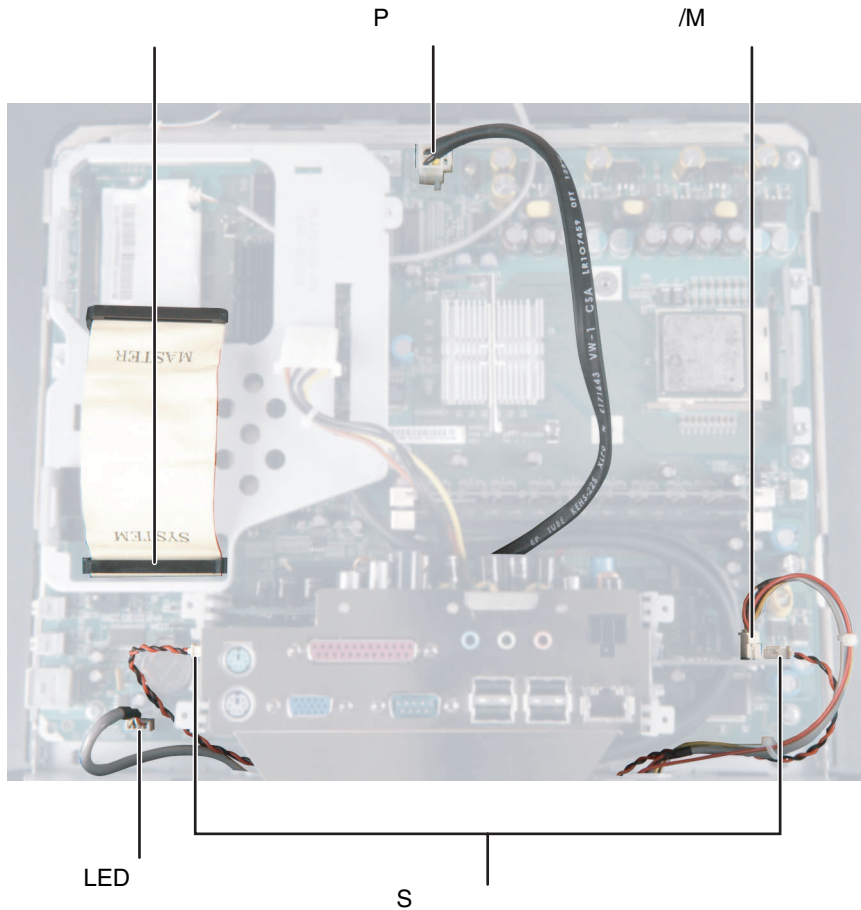

- 25** Remove the five screws holding the hard drive suspension plate to the system board, then remove the plate.

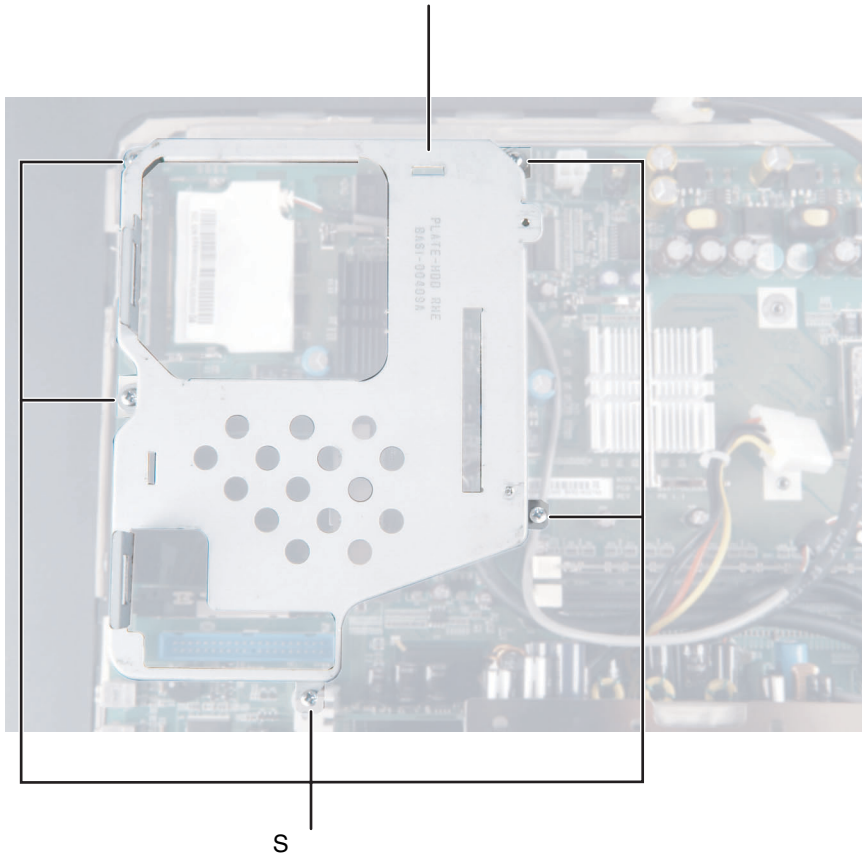

- 26** Remove the two screws holding the card retention plate to the computer chassis, then remove the plate.

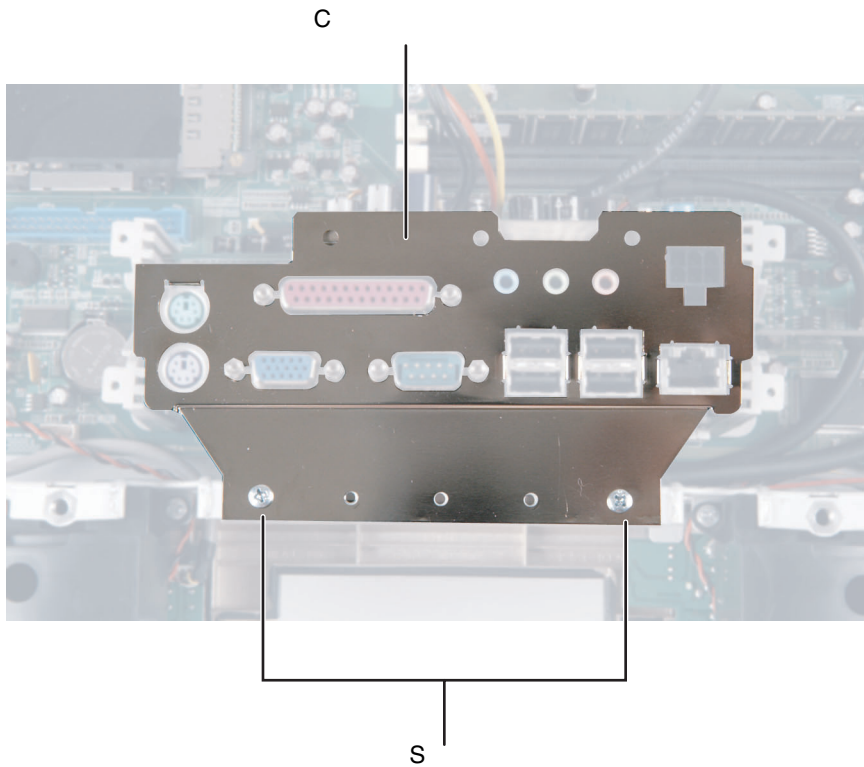

- 27** Remove the three screws securing the two gray card brackets to the system board.

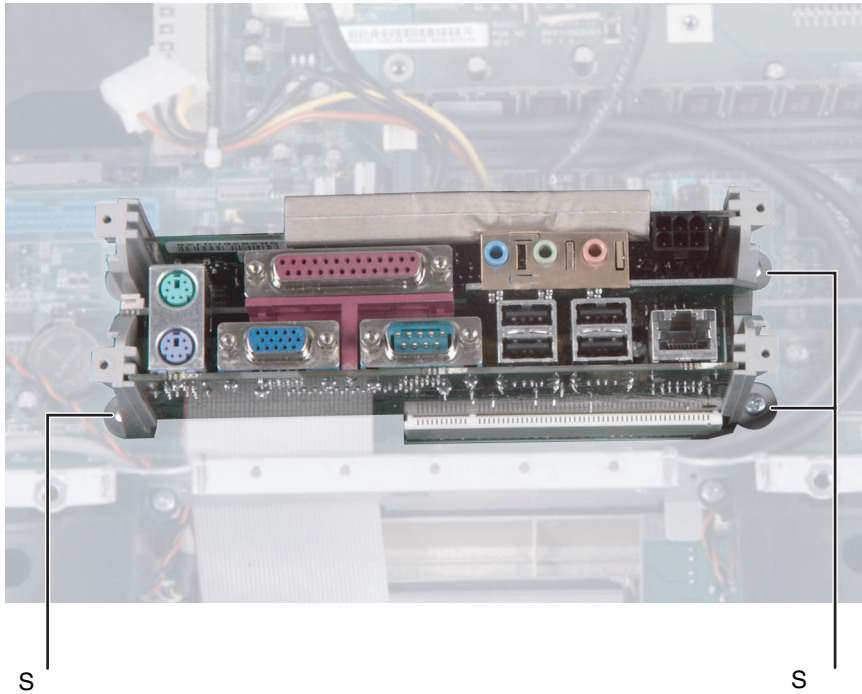

- 28** Remove the two gray card brackets.
- 29** Remove the three cards from the system board. Note each card's location and orientation. You will reinstall these cards later. You can slightly seesaw a card end-to-end as you work it out of the slot, but **do not bend the card sideways**.

- 30 Disconnect the LCD video, LCD power, diskette drive, and optical drive cables from the system board. Note the location and orientation of each cable. You will reconnect these cables later.

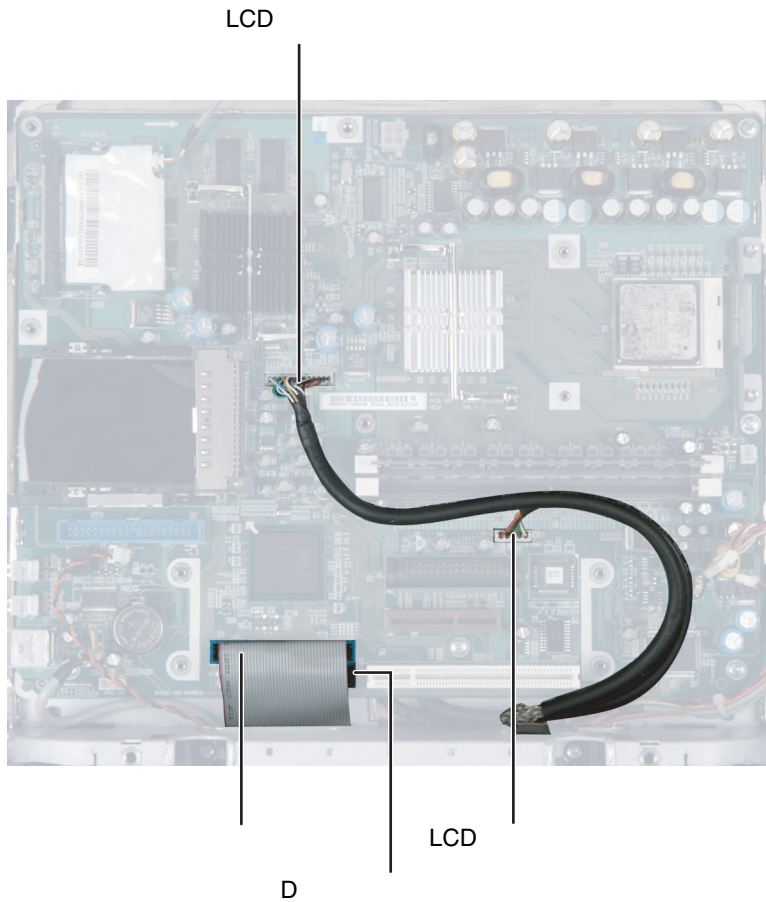

31 Remove the five additional system board retaining screws.

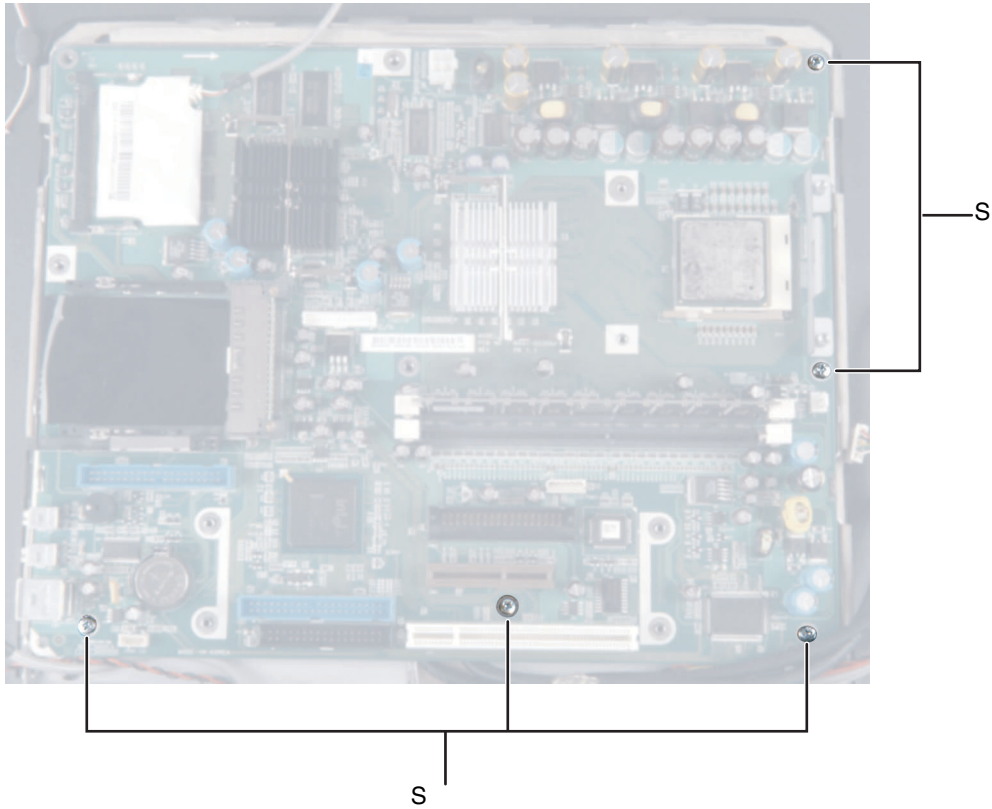

32 Lift the system board away from the computer.

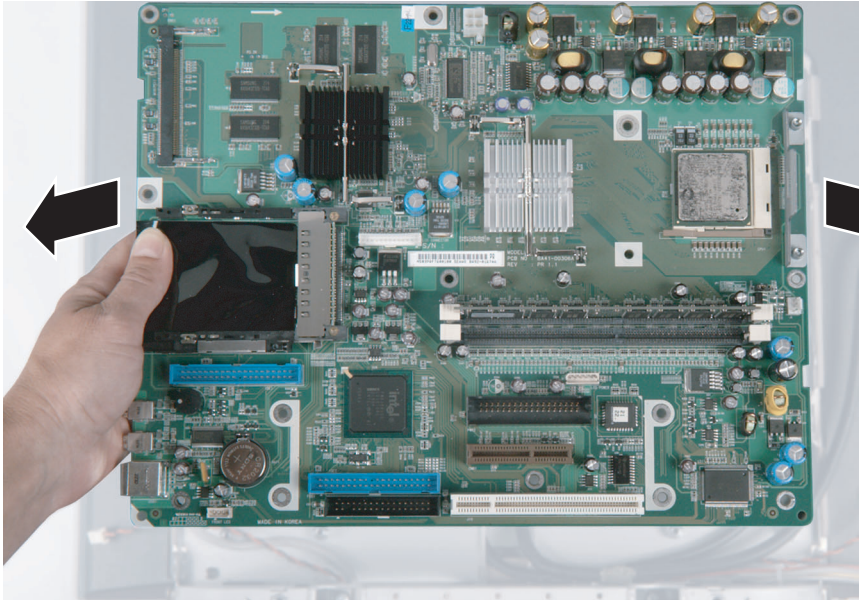

33 Secure the new system board to the computer with the five screws removed in Step 31.

- 34 Connect the LCD video, LCD power, diskette drive, and optical drive cables to the system board using the notes you made in Step 30.

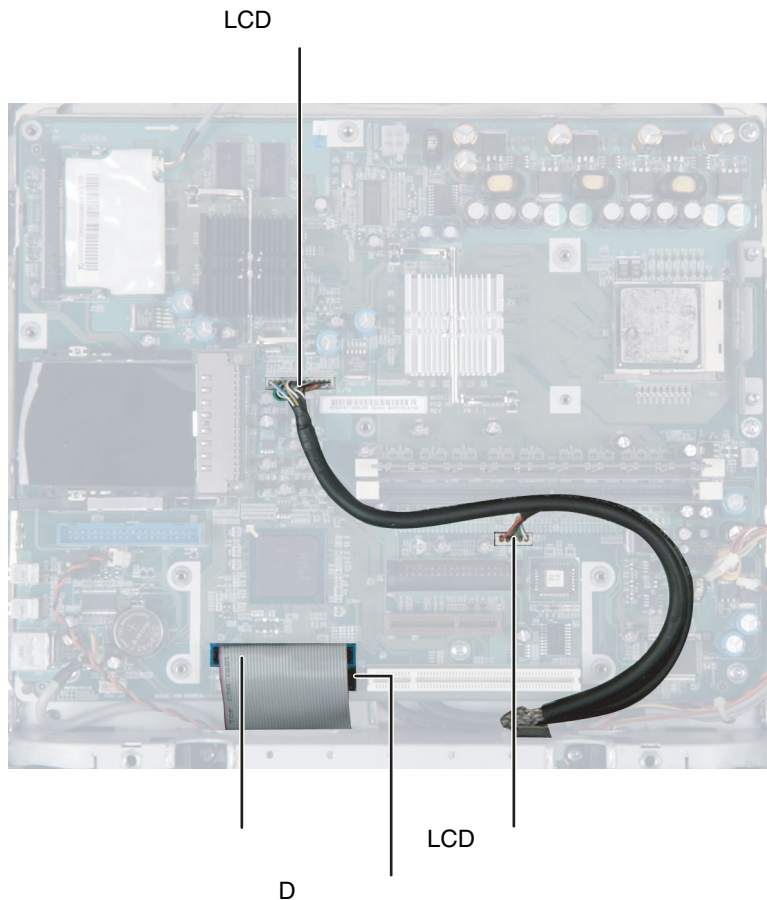

- 35 Secure the two card brackets to the system board with the three screws removed in Step 27.
- 36 Insert the three cards into the slots using the notes you made in Step 29. You can slightly seesaw a card end-to-end as you insert it into the slot, but **do not bend the card sideways**.
- 37 Secure the card retention plate to the computer chassis with the two screws removed in Step 26.

- 38 Secure the hard drive suspension plate to the system board with the five screws removed in Step 25.
- 39 Connect the hard drive, power, and LED cables to the system board, then connect the speaker and headphone/microphone jack cable to the audio card using the notes you made in Step 24.

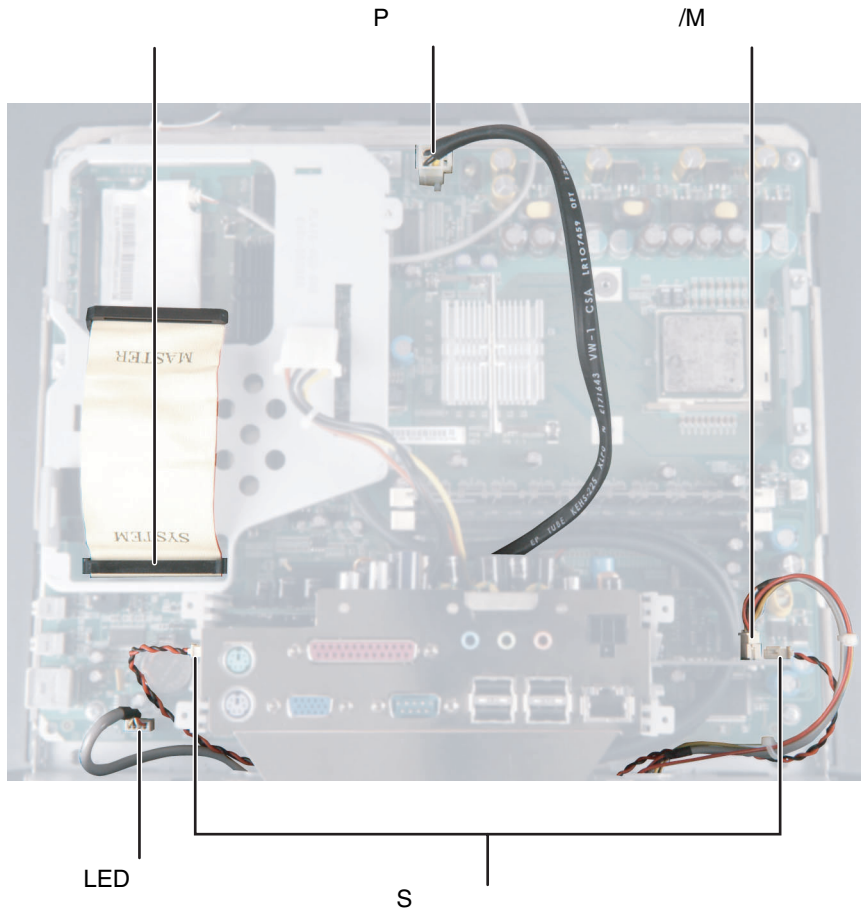

- 40 Replace the case cover making sure that the case retaining tabs snap into place.

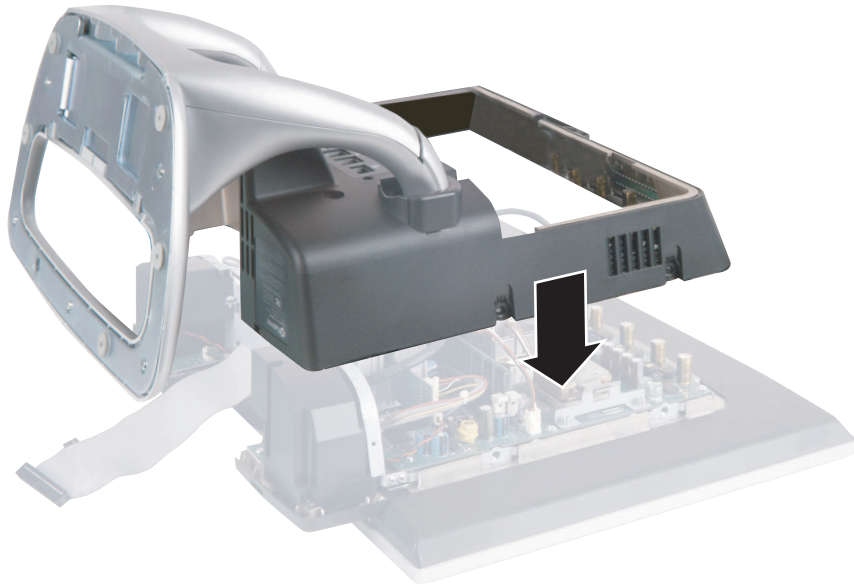

- 41 Replace the four side screws and screw caps removed in Step 19 and Step 20.
- 42 Replace the six back case cover screws removed in Step 17.
- 43 Plug the antenna cables back into the wireless network card. The white wire connects to the post labeled **MAIN**, and the black wire connects to the post labeled **AUX**.
- 44 Secure the wires to the wireless network card by reapplying the tape you removed in Step 12.

- 45** Align the heatsink tab into the slot on the system board and swing the heatsink back into place, then secure the heatsink with the four screws removed in Step 15.

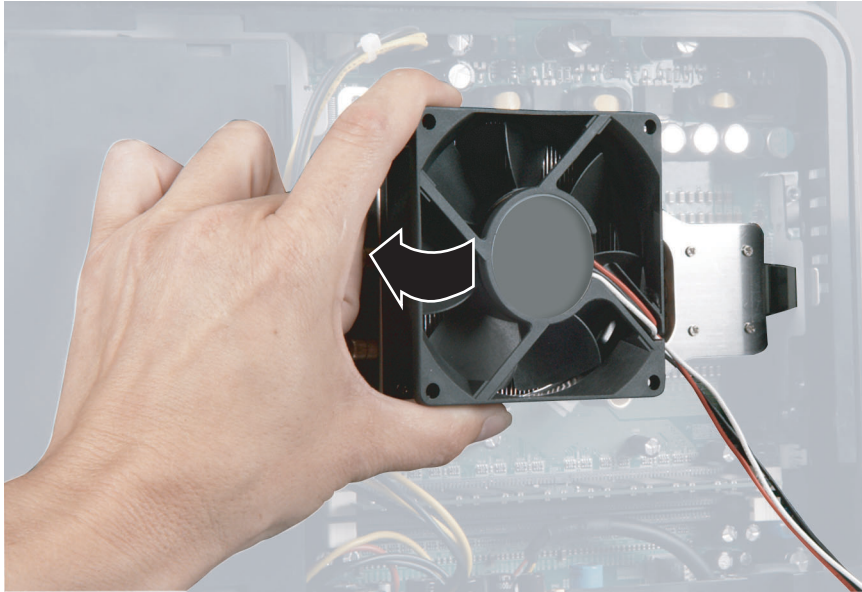

- 46** Connect the fan power cable.
- 47** Connect the drive cable and power cable to the hard drive pack using the notes you made in Step 9.

- 48** Align the single hard drive cage tab into the case notch, then swing the hard drive cage down until the two hard drive cage tabs on the other side snap into place.



- 49** Make sure that all of the internal cables are arranged inside the case so they will not be pinched when you close the case.
- 50** Replace the PC Card eject button cover.

- 51** Align the access panel tabs into the case notches.

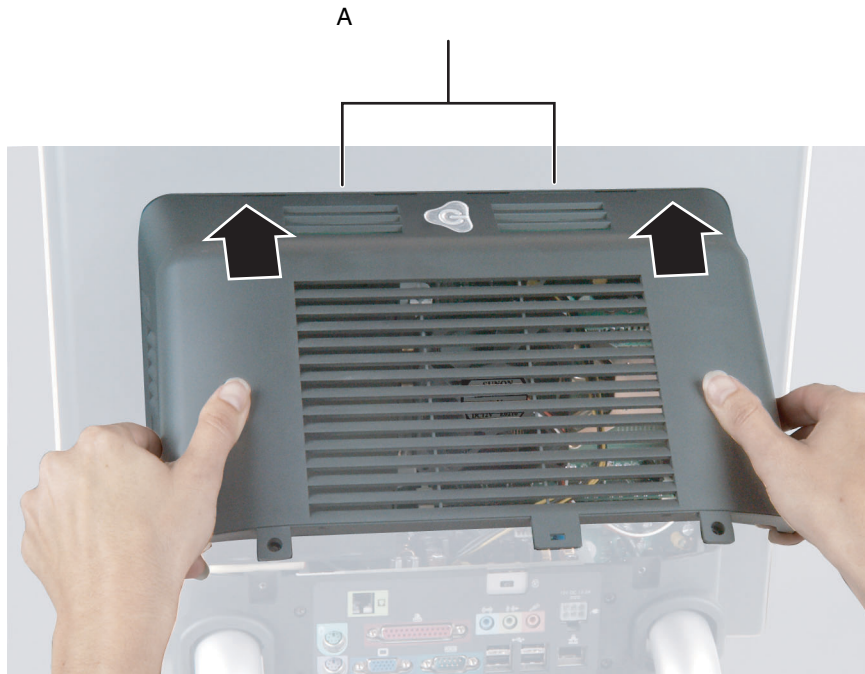

- 52** Swing the access panel down into place and secure it with the two screws removed in Step 5.
- 53** Return the computer to the upright position.
- 54** Connect the drive cables to the drive adapter card on the drive pack using the notes you made in Step 4. The drive cables and connectors are “keyed,” which means that they can only be plugged in one way.
- 55** Push the cables carefully up into the top of the drive bay.

- 56** Align the tabs on the drive pack with the notches on the drive bay, then slide the drive pack back until it is flush with the front of the case.

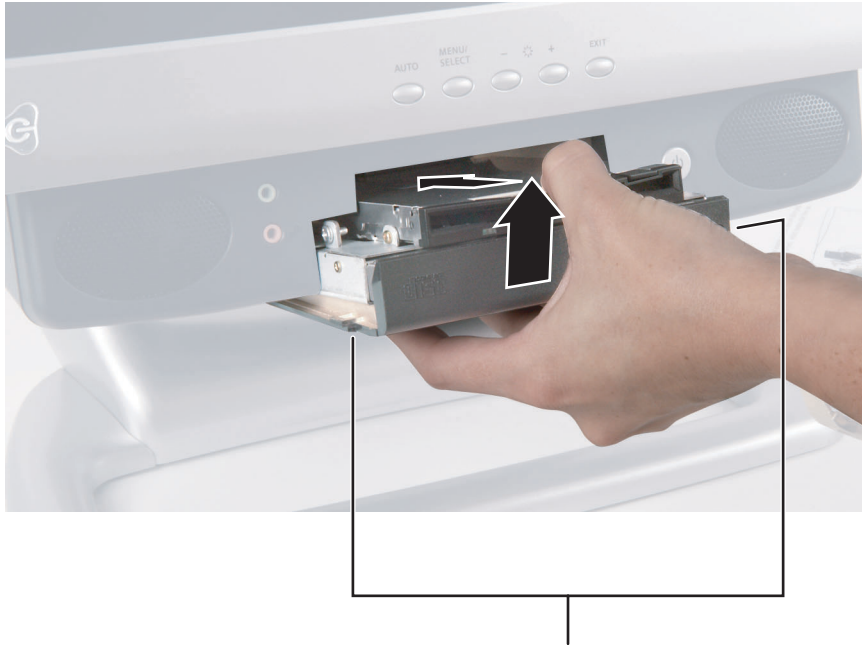

- 57** Secure the drive pack with the two screws removed in Step 2.



MAN US PFL4.5 SERVICE GDE R1 10/03



8509571