HP OmniBook Port Replicator

User's Guide

Notice

This manual and any examples contained herein are provided “as is” and are subject to change without notice. Hewlett-Packard Company makes no warranty of any kind with regard to this manual, including, but not limited to, the implied warranties of merchantability and fitness for a particular purpose. Hewlett-Packard Co. shall not be liable for any errors or for incidental or consequential damages in connection with the furnishing, performance, or use of this manual or the examples herein.

Consumer transactions in Australia and the United Kingdom: The above disclaimers and limitations shall not apply to Consumer transactions in Australia and the United Kingdom and shall not affect the statutory rights of Consumers.

© Copyright Hewlett-Packard Company 1997. All rights reserved. Reproduction, adaptation, or translation of this manual is prohibited without prior written permission of Hewlett-Packard Company, except as allowed under the copyright laws.

The programs that control this product are copyrighted and all rights are reserved. Reproduction, adaptation, or translation of those programs without prior written permission of Hewlett-Packard Co. is also prohibited.

Portions of the programs that control this product may also be copyrighted by Microsoft Corporation, SystemSoft Corp., Advanced Micro Devices, Inc., Crystal Semiconductor Corporation, and Chips & Technologies, Inc. See the individual programs for additional copyright notices.

Microsoft, MS, MS-DOS, and Windows are registered trademarks of Microsoft Corporation (U.S. patent numbers 4955066 and 4974159). Pentium is a U.S. registered trademark of Intel Corporation. TrackPoint is a U.S. trademark of International Business Machines.

For warranty information, see the *Support and Service* booklet.

Hewlett-Packard Company
Mobile Computing Division
1000 N.E. Circle Blvd.
Corvallis, OR 97330, U.S.A.

HP Software Product License Agreement

Your HP OmniBook PC contains factory-installed software programs. Please read the Software License Agreement before proceeding.

Carefully read this License Agreement before proceeding to operate this equipment. Rights in the software are offered only on the condition that the customer agrees to all terms and conditions of the License Agreement. Proceeding to operate the equipment indicates your acceptance of these terms and conditions. If you do not agree with the terms of the License Agreement, you must now either remove the software from your hard disk drive and destroy the master disks, or return the complete computer and software for a full refund.

Proceeding with configuration signifies your acceptance of the License Terms.

Unless otherwise stated below, this HP Software Product License Agreement shall govern the use of all software that is provided to you, the customer, as part of the HP computer product. It shall supersede any non-HP software license terms that may be found online, or in any documentation or other materials contained in the computer product packaging.

Note: Operating System Software by Microsoft is licensed to you under the Microsoft End User License Agreement (EULA) contained in the Microsoft documentation.

The following License Terms govern the use of the software:

Use. Customer may use the software on any one computer. Customer may not network the software or otherwise use it on more than one computer. Customer may not reverse assemble or decompile the software unless authorized by law.

Copies and Adaptations. Customer may make copies or adaptations of the software (a) for archival purposes or (b) when copying or adaptation is an essential step in the use of the software with a computer so long as the copies and adaptations are used in no other manner.

Ownership. Customer agrees that he/she does not have any title or ownership of the software, other than ownership of the physical media. Customer acknowledges and agrees that the software is copyrighted and protected under the copyright laws. Customer acknowledges and agrees that the software may have been developed by a third party software supplier named in the copyright notices included with the software, who shall be authorized to hold the Customer responsible for any copyright infringement or violation of this Agreement.

Product Recovery CD-ROM. If your computer was shipped with a product recovery CD-ROM: (i) The product recovery CD-ROM and/or support utility software may only be used for restoring the hard disk drive of the HP computer with which

the product recovery CD-ROM was originally provided. (ii) The use of any operating system software by Microsoft contained in any such product recovery CD-ROM shall be governed by the Microsoft End User License Agreement (EULA).

Transfer of Rights in Software. Customer may transfer rights in the software to a third party only as part of the transfer of all rights and only if Customer obtains the prior agreement of the third party to be bound by the terms of this License Agreement. Upon such a transfer, Customer agrees that his/her rights in the software are terminated and that he/she will either destroy his/her copies and adaptations or deliver them to the third party.

Sublicensing and Distribution. Customer may not lease, sublicense the software or distribute copies or adaptations of the software to the public in physical media or by telecommunication without the prior written consent of Hewlett-Packard.

Termination. Hewlett-Packard may terminate this software license for failure to comply with any of these terms provided Hewlett-Packard has requested Customer to cure the failure and Customer has failed to do so within thirty (30) days of such notice.

Updates And Upgrades. Customer agrees that the software does not include updates and upgrades which may be available from Hewlett-Packard under a separate support agreement.

Export Clause. Customer agrees not to export or re-export the software or any copy or adaptation in violation of the U.S. Export Administration regulations or other applicable regulation.

U.S. Government Restricted Rights. Use, duplication, or disclosure by the U.S. Government is subject to restrictions as set forth in subparagraph (c)(1)(ii) of the Rights in Technical Data and Computer Software clause in DFARS 252.227-7013. Hewlett-Packard Company, 3000 Hanover Street, Palo Alto, CA 94304 U.S.A. Rights for non-DOD U.S. Government Departments and Agencies are as set forth in FAR 52.227-19(c)(1,2).

Edition History

Edition 1 May 1997



This manual is printed on recycled paper.

Contents

1. Using the port replicator	1-7
Understanding the Basics	1-10
To update the OmniBook BIOS	1-10
To dock the OmniBook	1-11
To undock the OmniBook	1-12
To attach a security cable	1-13
Making Connections	1-14
To connect an external keyboard	1-15
To connect a PS/2 mouse	1-15
To switch back to the internal pointing device	1-16
To connect a serial mouse	1-16
To connect a serial device	1-17
To connect an external display	1-18
To enable the built-in and external displays simultaneously	1-18
To connect a parallel device	1-19
To connect your audio equipment	1-19
To connect a MIDI/Joystick device	1-20
2. Troubleshooting	1-21
Solving Problems	1-23
3. Specifications and Regulatory Information	1-25
Specifications	1-27
Regulatory Information	1-28
U.S.A.	1-28
Canada	1-29
Japan	1-29
Declaration of Conformity	1-30



Using the Port Replicator

Using the Port Replicator

With the OmniBook port replicator, you can significantly increase the capabilities of your OmniBook. By making one connection—plugging your OmniBook into the port replicator—you can get convenient access to these types of connections:

- ◆ Printer or other parallel device
- ◆ Modem or other serial device.
- ◆ External keyboard and external mouse.
- ◆ External monitor.
- ◆ Audio connections.
- ◆ Power.
- ◆ MIDI/Joystick.

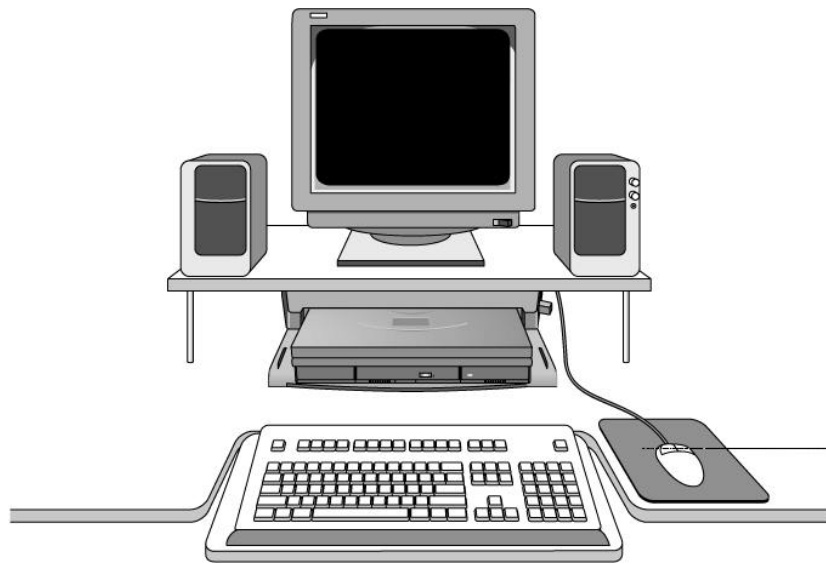

How to Use This manual

The procedures in this manual differ slightly depending on the operating system you've installed—Windows 95 or Windows for Workgroups. Read each step carefully to see if it applies to your operating system.

What About Other Operating Systems?

If you've installed another operating system on the OmniBook—Windows NT or OS/2, for example—follow the general procedures under Windows for Workgroups. Instead of exiting Windows (when so instructed), exit the operating system you are using.

Your OmniBook provides these additional manuals:

- The online OmniBook *User's Guide* : This introduces the OmniBook and shows you how to operate and maintain your OmniBook. It also contains troubleshooting information. Look in the OmniBook Library group.
- The *Introducing Microsoft Windows 95* manual: This is shipped with your OmniBook and contains information about using the standard features of Windows 95.
- The online *Windows Quick Start* and *MS-DOS Quick Start* manuals: These are in the OmniBook Library group for Windows® for Workgroups.
- The OmniBook Website at <http://www.hp.com/go/omnibook>
The Corporate Evaluator's Guide at our Website provides complete information about installing alternate operating systems, as well as how to configure the OmniBook in a corporate, networked environment.

Understanding the Basics

This section shows you how to get your port replicator and OmniBook up and running quickly, including how to

- ◆ Update the OmniBook BIOS to enable docking.
- ◆ Docking the OmniBook.
- ◆ Undocking the OmniBook.
- ◆ Attach a security cable.

To update the OmniBook BIOS

Depending on when you purchased the OmniBook, you may need to update the OmniBook BIOS to enable docking. The Update program automatically checks your BIOS version and displays a message if you do not need to update the BIOS. .

1. Important
Attach ac power to the OmniBook.
2. Insert the BIOS Update disk in drive A: and turn on the OmniBook.
Be careful to check the label of the floppy disk for the correct language to install.
3. When the Update BIOS screen appears, press C to continue.
Do not interrupt the update process.
4. When prompted, remove the Update disk and reset the OmniBook.

To dock the OmniBook

1. Plug the power cord into the ac adapter, then into a grounded ac outlet. Plug the ac adapter into the port replicator.

Important

Never connect the OmniBook to the port replicator without *first* connecting ac power. An extra ac adapter is provided to ensure that the port replicator is always usable and ready to support the OmniBook.

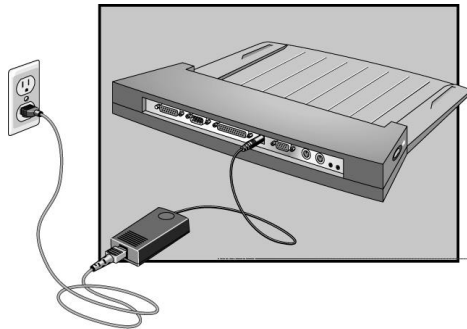

2. Unplug all cables from the back of the OmniBook.
3. Open the OmniBook's docking port door and slide the door under the port.

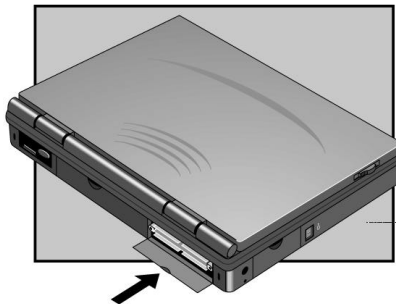

Using the Port Replicator
Understanding the Basics

4. While firmly holding the OmniBook against the docking pins, slide the docking lever back and release, then press the blue On/Suspend button.

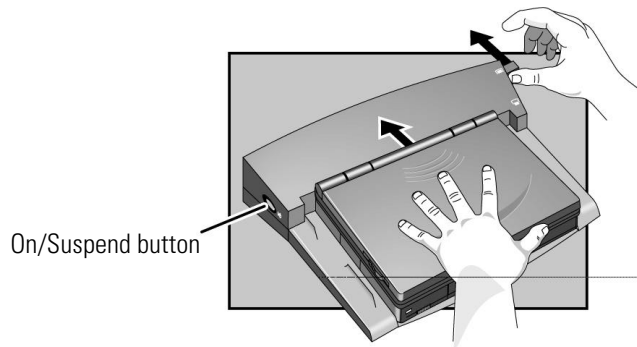

To undock the OmniBook

1. Make sure ac power is connected to the port replicator.
2. Exit Windows and turn off the OmniBook (blue On/Suspend button).
3. Slide the docking lever forward to release the OmniBook, then slide the OmniBook completely out of the port replicator.

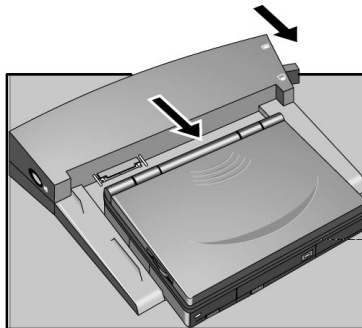

To attach a security cable

Your port replicator has a built-in security port that allows you to secure the port replicator with a cable. Kensington MicroSaver lock systems work with these ports and are available at many computer stores.

1. Dock the OmniBook in the port replicator.
2. Wrap the cable around a stationary object, such as a table leg.
3. Loop the cable to create a slip knot around the stationary object.
4. Insert the lock into the port replicator's security port and release the key. The lock prevents the undock lever from releasing the OmniBook. Store the key in a safe place away from the OmniBook.

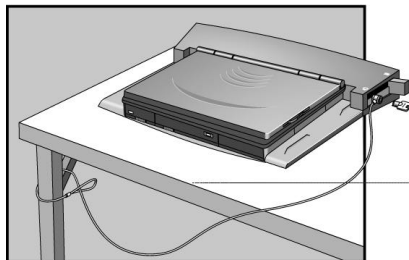

Making Connections

This section describes how to connect devices to the port replicator, including the following:

- ◆ AC adapter (see page 1-11 for instructions).
- ◆ External keyboard.
- ◆ External PS/2 or serial mouse.
- ◆ External display.
- ◆ Printer or other parallel device (25-pin).
- ◆ Modem or other serial device (9-pin).
- ◆ MIDI or game device.
- ◆ External audio device.
- ◆ Headphones or external (amplified) speakers.

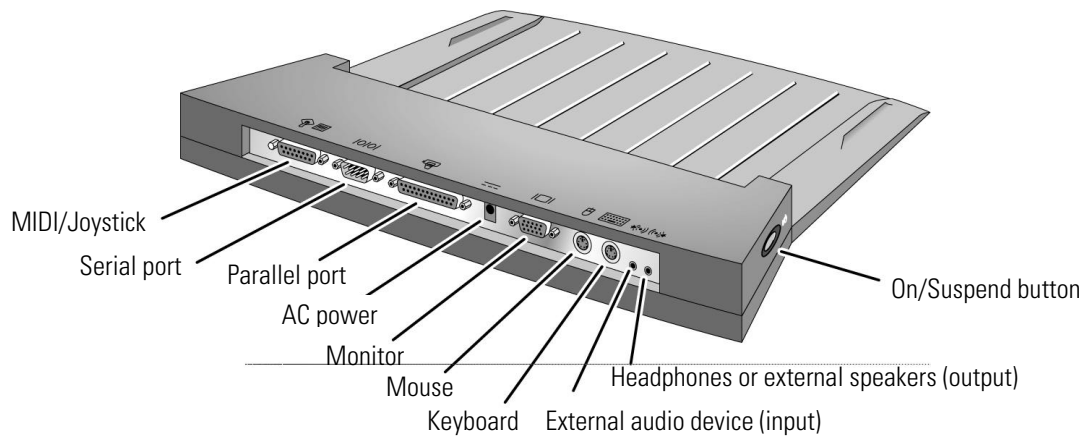

To connect an external keyboard

You can use both the built-in keyboard and external keyboard while docked.

1. Attach the keyboard cable to the port replicator.
2. Dock the OmniBook in the port replicator.

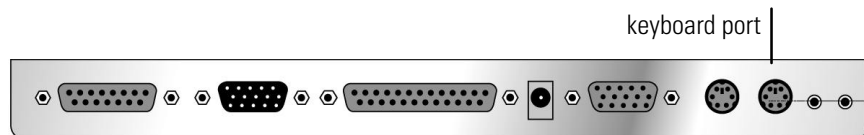

Hint

If you are using a port replicator with an external keyboard, substitute the keystrokes CTRL+ALT for Fn. You must also enable the “external” Fn key.

1. Press Fn+F2 to open the System Configuration Utility.
2. Press ALT+I to open the Input/Output menu.
3. Select External Devices.
4. Select the Enable External Fn Key check box.

To connect a PS/2 mouse

The OmniBook has a PS/2 mouse driver installed. When you dock, the OmniBook automatically detects and sets up the mouse.

1. Attach the mouse cable to the docking system.
2. Dock the OmniBook in the port replicator.
3. If you're not using Windows 95, reboot the OmniBook.

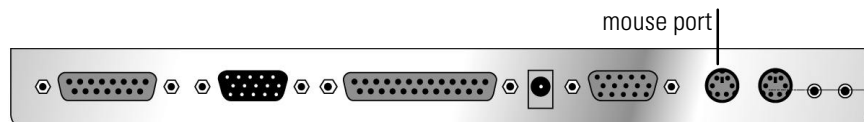

To switch back to the internal pointing device

Use this procedure to switch back to the built-in pointing device from an external PS/2 mouse.

1. Save your work.
2. Disconnect the mouse cable from the docking system.
3. Turn the OmniBook off, then back on.

Hint

You can also disable the external pointing device from the System Configuration Utility.

1. Press Fn+F2 to open the System Configuration Utility.
 2. Press ALT+I to open the Input/Output menu.
 3. Select External Devices.
 4. Select the Ignore External Pointing Device check box.
-

To connect a serial mouse

1. If you're using Windows 95, go to step 2.

–or–

If you're using Windows for Workgroups, save your work and exit Windows. You'll be rebooting the OmniBook.

2. Attach the serial mouse to the port replicator.

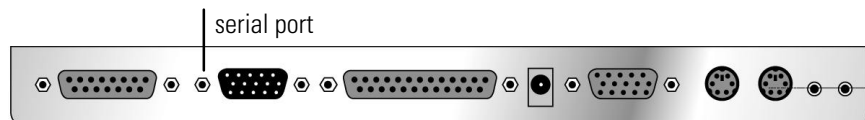

3. Dock the OmniBook in the port replicator.

4. If you're using Windows 95, go to step 5.

–or–

If you're using Windows for Workgroups, reboot the OmniBook.

5. If you're using Windows 95

- Click Start, Settings, Control Panel, Mouse, General.
- Click Change, then select Standard Serial Mouse.

–or–

If you're using Windows for Workgroups

- From Program Manager, run Windows Setup, then Change Systems Setting.
- Select Serial Mouse.

To connect a serial device

The port replicator's nine-pin serial port is a standard PC serial port. Serial connections typically are to printers, modems, or other computers. You can make such connections using standard serial cables and adapters available at computer dealers and electronic supply stores.

Use the following procedure to connect a modem, serial printer, or serial cable.

1. Attach the serial cable to the serial port.
2. Dock the OmniBook in the port replicator.

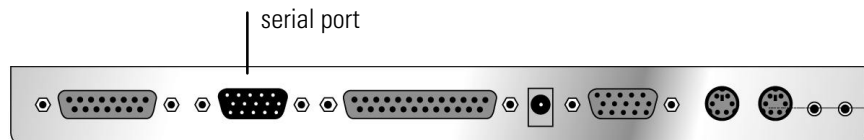

To connect an external display

Use this procedure to connect an external display to your OmniBook. Before beginning, check the documentation for your display and make sure that the external display supports standard VGA, SVGA, or XGA format.

1. Attach the display cable to the display port.
2. Dock the OmniBook in the port replicator.

The OmniBook automatically recognizes and activates the external display. The built-in display turns off. If you want to run the built-in display and an external display simultaneously, see the following topic for instructions.

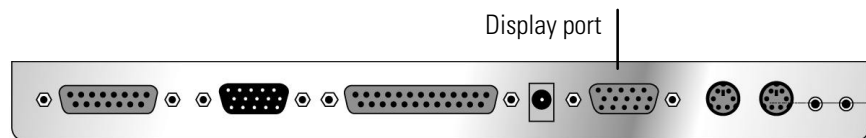

To enable the built-in and external displays simultaneously

The System Configuration Utility provides a setting for turning the built-in display on and off.

1. Press Fn+F2 to open the System Configuration Utility.
2. Press ALT+I to open the Input/Output menu.
3. Select External Devices.
4. Select the Both External VGA and LCD check box.
5. Save and exit.

Hint

You can also use Fn+F5 to switch between the external and built-in displays.

To connect a parallel device

The port replicator's 25-pin parallel port is a standard enhanced (EPP/ECP) parallel port. Parallel connections typically are to printers or other computers.

1. Attach the parallel cable to the parallel port.
2. Dock the OmniBook in the port replicator.
3. If necessary, install your printer or other device driver.
See your Windows manual for instructions.

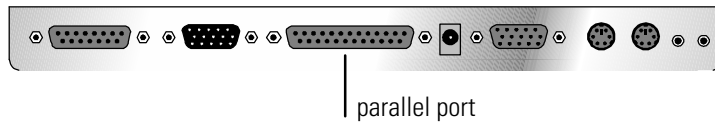

To connect your audio equipment

The port replicator provides one audio-output port and one audio-input port. You can connect headphones, external (amplified) stereo speakers, or an external audio source (such as a CD player) to the port replicator.

1. Attach the audio cable to the input or output port.
2. Dock the OmniBook in the port replicator.

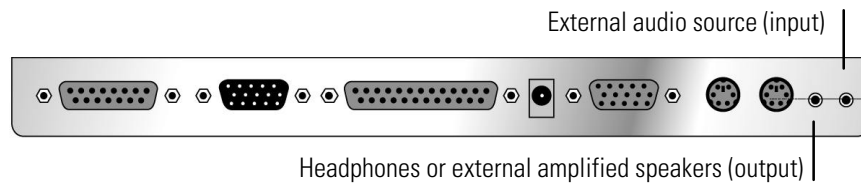

To connect a MIDI/Joystick device

1. Attach the cable to the MIDI/Joystick port.
2. Dock the OmniBook in the port replicator.

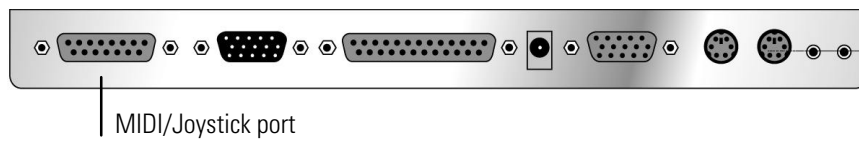



———— Troubleshooting

Troubleshooting

There are many ways to get information and technical support for your OmniBook and port replicator. If you have a question about your port replicator that this manual does not answer, you can try any of the following sources:

- The online OmniBook *User's Guide*

The online manual provides complete instructions about how to operate and maintain your OmniBook. You can view the manual online or print it.

- The World Wide Web

The HP Web site provides information about HP mobile-computing products. You can download new software and drivers, get detailed setup instructions, or view a list of common questions and answers. You can also find out how to get information and ask questions through CompuServe and America Online. The HP Web site address is <http://www.hp.com/go/omnibook>.

- Technical Support

If you'd like to talk to a trained representative, you can call Technical Support. If the product is under warranty, the technical assistance is normally free. Your only charge will be the telephone call and you will speak directly to a support specialist.

The Technical Support telephone number for your area is listed in the *Support and Service* booklet that you received with your OmniBook.

- HP First (automated fax service)

You can also use the HP automated fax service. Through HP First, you can access thousands of documents that provide help or information by fax.

The HP First telephone number is:

(800) 333-1917 (inside U.S. and Canada).

(208) 344-4809 (outside U.S. and Canada).

Solving Problems

If you have a problem using the port replicator, find the symptom that matches your situation. Try the suggestions one at a time.

If you need to replace a lost or damaged power cord

For the replacement part number for the ac adapter power cord, contact the number in the *Support and Service* booklet.

If a serial or parallel device or external display doesn't work

- Make sure the OmniBook is fully inserted in the port replicator. The connection should be snug.
- Make sure the ends of the serial or parallel cable are connected properly.
- Make sure the device and the port replicator are connected and both have power.
- Reboot the OmniBook.

If an external PS/2 mouse or keyboard doesn't work

- Make sure the OmniBook is fully inserted in the port replicator. The connection should be snug.
- Make sure the mouse is plugged into the correct port. The mouse and keyboard ports look the same. See page 1-15.
- Reboot the system.
- Undock the OmniBook, unplug and reconnect the ac adapter, then dock again.

If your docking password isn't accepted

- Check whether Num Lock and/or Caps Lock are off.
- If you've forgotten your password, have your OmniBook and proof-of-purchase at hand and call Hewlett-Packard support. See your OmniBook *Support and Service* booklet.

**Specifications and Regulatory
Information**

Specifications and Regulatory Information

Your OmniBook port replicator is designed to provide trouble-free operation. The following suggestions can help you while working with your OmniBook:

- ◆ If you have problems, see the problem-solving suggestions and references listed in chapter 2.
- ◆ If you think your port replicator might need repair service, see the warranty and service information in the *Support and Service* booklet.

To contact Hewlett-Packard

If you have questions that the OmniBook manuals don't answer (even after looking in the contents and index), you can contact Hewlett-Packard at the address or phone number listed in the *Support and Service* booklet or in OmniBook Support in the online OmniBook Library. Please have your OmniBook with you.

Specifications

Ports Replicated	Parallel DB25 (EPP/ECP). Serial DB9 (115,200-bps). PS/2 keyboard. PS/2 mouse. MIDI/joystick DB15. Video-out DB15. Audio line in. Audio headphone out.
Convenience features	EasyTouch docking lever assists user with inserting and removing notebook from port replicator. GlideRail ramp facilitates notebook alignment. Side-located power switch provides convenient access while notebook is closed or located under a monitor stand.
Power	Includes F1044B universal ac adapter. ac adapter 100 to 240 Vac (50 to 60 Hz) input; 12 Vdc, 3.3 A output.
Security features	Kensington lock slot prevents docking lever from releasing notebook.
Size	36.8 x 26.7 x 5.7 cm. (14.5 x 10.5 x 2.25 in).
Weight	1.07 kg (2.35 lb).
Warranty	1-year return-to-HP for repair.
Ordering information	F1349A port replicator . Options available for different power cords.
3rd-party accessories	Monitor stand from: CNF Inc. Morgan Hill, CA USA 408 778-1160 www.cnfinc.com

Regulatory Information

This section presents information that shows how the port replicator complies with regulations in certain regions. Any modifications to the port replicator not expressly approved by Hewlett-Packard could void the authority to operate the port replicator in these regions.

This port replicator is for use only with the I.T.E. (Information Technology Equipment) notebook computer, model HP OmniBook 2000/5700.

U.S.A.

The port replicator generates and uses radio frequency energy and may interfere with radio and television reception. The port replicator complies with the limits for a Class B computing device as specified in Part 15 of FCC Rules, which provide reasonable protection against such interference in a residential installation. The FCC label for this product is visible on the bottom of the unit. In the unlikely event that there is interference to radio or television reception (which can be determined by undocking the OmniBook and unplugging the ac adapter), try the following:

- Reorienting or relocating the receiving antenna.
- Relocating the port replicator with respect to the receiver.
- Connecting the ac adapter to another power outlet.

To maintain compliance with FCC Rules and Regulations, use properly shielded cables when connecting peripheral devices to this device. Use cables supplied with the OmniBook when appropriate.

For more information, consult your dealer, an experienced radio/television technician, or the following booklet, prepared by the Federal Communications Commission: *How to Identify and Resolve Radio-TV Interference Problems*. This booklet is available from the U.S. Government Printing Office, Washington, DC 20402, Stock Number 004-000-00345-4. At the first printing of this manual, the telephone number was (202) 783-3238.

Canada

This digital apparatus does not exceed the Class B limits for radio noise emissions from digital apparatus as set out in the radio interference regulations of the Canadian Department of Communications.

Le présent appareil numérique n'émet pas de bruits radioélectriques dépassant les limites applicables aux appareils numériques de Classe B prescrites dans le règlement sur le brouillage radioélectrique édicté par le Ministère des Communications du Canada.

Japan

この装置は、情報処理装置等電波障害自主規制協議会（VCCI）の基準に基づく第二種情報技術装置です。この装置は、家庭環境で使用することを目的としていますが、この装置がラジオやテレビジョン受信機に近接して使用されると、受信障害を引き起こすことがあります。

取扱説明書に従って正しい取り扱いをして下さい。

Declaration of Conformity

Products sold by Hewlett-Packard and its authorized dealers meet the specifications listed below, according to ISO/IEC Guide 22 and EN 45014.

Manufacturer:	Hewlett-Packard Company
Address:	Hewlett-Packard Co. Mobile Computing Division 1000 NE Circle Blvd. Corvallis, OR 97330 declares that the following product
Product name:	HP F1349A port replicator
Options:	All conforms to the following product specifications
Safety:	IEC 950:1991+A1,A2 / EN 60950 (1992)+A1,A2
EMC:	CISPR 22:1993 / EN 55022 (1994): Class B [1] EN 50082-1:1992 IEC 1000-4-2:1995 / prEN 55024-2 (1992): 4kV CD, 8kV AD IEC 1000-4-3:1995 / prEN 55024-3 (1991): 3V/m IEC 1000-4-4:1995 / prEN 55024-4 (1992): 0.5kV signal lines, 1.0kV power lines ANSI C63.4:1992
Supplementary Information:	The product herewith complies with the requirements of the EMC Directive 89/336/EEC, Part 15 of the FCC Rules (97-6430-004-I), and carries the CE mark accordingly. [1] The product was tested in a typical configuration with Hewlett-Packard personal computer peripherals.

Quality Department
Hewlett-Packard Company
Mobile Computing Division

Index

A

- ac power, 1-11
- ac power cord, 1-23
- amplified speakers, 1-19

B

- BIOS
 - updating, 1-10

C

- cables
 - security lock, 1-13
- CD player, 1-19
- connecting, 1-17
 - ac power, 1-11
 - audio equipment, 1-19
 - external display, 1-18
 - keyboard, 1-15
 - MIDI/Joystick, 1-20
 - parallel device, 1-19
 - PS/2 mouse, 1-15
 - serial device, 1-17
 - serial mouse, 1-16
- contacting HP, 1-26

D

- display
 - enabling, 1-18
 - external, 1-18
 - troubleshooting, 1-23

- docking port, 1-11
- documentation, 1-22

E

- enabling
 - external display, 1-18
 - external Fn key, 1-15

F

- fax service, 1-22

H

- headphones, 1-19
- HP First, 1-22

J

- joystick, 1-20

K

- Kensington lock, 1-13
- keyboard, 1-15
 - troubleshooting, 1-23

L

- license agreement, 1-3

M

- MicroSaver lock, 1-13
- MIDI, 1-20

- modem, 1-17
- monitor. *See* display

O

- OmniBook
 - documentation, 1-22
 - repair, 1-26
 - specifications, 1-27
- On/Suspend, 1-12
- OS/2, 1-9

P

- parallel device, 1-19
 - troubleshooting, 1-23
- ports
 - ac, 1-11
 - audio, 1-19
 - display, 1-18
 - docking, 1-11
 - keyboard, 1-15
 - MIDI/Joystick, 1-20
 - parallel device, 1-19
 - PS/2 mouse, 1-15
 - serial device, 1-17
 - serial mouse, 1-16
- power cord, 1-23
- protection
 - security cable, 1-13
- PS/2 mouse
 - connecting, 1-15
 - switching back to TrackPoint, 1-16
 - troubleshooting, 1-23



R

- regulatory information, 1-28
- repair, 1-26
- replacing
 - power cord, 1-23

S

- SCU, 1-15
- security
 - cable, 1-13
- serial
 - device, 1-17, 1-23
 - mouse, 1-16
 - service (repair), 1-26
- software license, 1-3

- speakers, 1-19
- specifications, 1-27
- support, 1-22, 1-26
- SVGA, 1-18
- System Configuration Utility, 1-15

T

- technical specifications, 1-27
- technical support, 1-22
- troubleshooting, 1-23

U

- updating the BIOS, 1-10
- User's Guide, 1-22

V

- VGA, 1-18

W

- Windows NT, 1-9
- WWW, 1-22

X

- XGA, 1-18