

# HP OmniBook 5500

## User's Guide

(Windows 95)

<b>INTRODUCTION .....</b>	<b>5</b>
<b>Using This Online Manual .....</b>	<b>5</b>
<b>Finding More Information .....</b>	<b>5</b>
<b>Notice .....</b>	<b>5</b>
<b>1. GETTING COMFORTABLE .....</b>	<b>7</b>
<b>Identifying Parts of the OmniBook .....</b>	<b>7</b>
<b>Adjusting the Display .....</b>	<b>9</b>
To locate the display controls .....	9
To adjust the display .....	9
<b>Using the Pointing Device.....</b>	<b>10</b>
To use the pointing device .....	10
To clean the pointing device .....	10
To customize the pointing device .....	11
<b>Using Sound .....</b>	<b>12</b>
To adjust the speaker volume .....	12
To connect a microphone, speakers, or headphones.....	13
To record sound .....	14
To play sound .....	15
<b>Using the OmniBook Keyboard .....</b>	<b>15</b>
To use special features of the OmniBook keyboard.....	15
<b>Learning About Windows.....</b>	<b>16</b>
To learn about Windows .....	16
<b>2. OPERATING THE OMNIBOOK .....</b>	<b>18</b>
<b>Checking the Status of the OmniBook .....</b>	<b>18</b>
To check keyboard status .....	18
To check data storage status.....	18
To check power status .....	19
<b>Turning the OmniBook On and Off.....</b>	<b>19</b>
To turn off the OmniBook (Instant On mode) .....	20
To turn off the OmniBook (Save-To-Disk mode).....	20

To shut down the OmniBook .....	20
<b>Restarting the OmniBook.....</b>	<b>21</b>
To reboot from drive C .....	21
To reboot from a floppy disk .....	21
To reset the OmniBook .....	22
<b>Using Storage Devices.....</b>	<b>22</b>
To install the floppy drive .....	23
To remove the CD-ROM or floppy drive .....	24
To insert and eject a floppy disk.....	24
To install the CD-ROM drive.....	25
To insert and remove a CD .....	25
To insert a PC card .....	26
To remove a PC card .....	27
<b>Upgrading the OmniBook .....</b>	<b>28</b>
To find the system software version and memory size .....	28
To add memory to the OmniBook .....	28
To remove the hard drive.....	30
To install the hard drive.....	31
<b>Restoring Files .....</b>	<b>31</b>
To recover Windows 95 .....	31
To set up a PCMCIA or parallel port CD-ROM drive.....	32
To recover Windows for Workgroups.....	33
To make DOS 6.22 and Windows for Workgroups backup disks .....	34
To recover HP software programs .....	34
To read the online User's Guide.....	35
To install device drivers for other operating systems .....	35
<b>3. MANAGING BATTERY POWER .....</b>	<b>37</b>
<b>Recharging and Replacing Batteries .....</b>	<b>38</b>
To recharge the battery or run on ac power .....	38
To respond to a low-battery warning .....	39
To replace the battery.....	39
To install a second battery.....	41
<b>Monitoring Battery Power .....</b>	<b>41</b>
To get the battery status .....	42
To save battery power .....	42
To adjust the battery charging order.....	42
To change how power is managed.....	43
<b>4. PROTECTING YOUR OMNIBOOK .....</b>	<b>44</b>
<b>Attaching a Security Cable.....</b>	<b>44</b>
To attach a security cable.....	44
<b>Setting Up Password Protection .....</b>	<b>44</b>
To record your name or other PC identification.....	45

To set up a user password .....	45
To delete a password.....	47
To set up an administrator password.....	47
<b>Protecting Your Data.....</b>	<b>49</b>
To repair and clean up a disk .....	49
To delete a set of OmniBook files.....	49
<b>5. THE PERSONAL INFORMATION APPLICATIONS .....</b>	<b>51</b>
<b>Managing Your Time with Appointment Book .....</b>	<b>51</b>
To start Appointment Book.....	51
To view your appointments .....	51
To add a new appointment.....	52
To add a new event.....	53
To delete an appointment or event .....	54
To exit Appointment Book.....	54
<b>Finding People with the Phone Book.....</b>	<b>54</b>
To start Phone Book .....	54
To add a name to the Phone Book .....	55
To search for a name .....	56
To exit Phone Book .....	56
<b>Getting Answers from HP Financial Calculator.....</b>	<b>56</b>
To start HP Calculator .....	56
To perform a math function on one number .....	56
To do simple arithmetic.....	57
<b>6. MAKING CONNECTIONS .....</b>	<b>59</b>
<b>Connecting a Printer .....</b>	<b>59</b>
To install a printer.....	59
To change the printer's settings .....	60
<b>Connecting an External Display.....</b>	<b>60</b>
To connect an external monitor.....	61
To change the display type.....	61
To switch between external and built-in displays.....	62
To connect a television or VCR.....	62
To change the television type (NTSC or PAL) .....	62
To connect an SVHS device.....	63
<b>Connect an External Mouse and Keyboard .....</b>	<b>63</b>
To connect an external mouse or keyboard.....	63
To enable external FN keys.....	64
To connect an external mouse and keyboard .....	64
<b>Making Serial Connections .....</b>	<b>65</b>
To connect a serial device .....	65
To view or change serial port assignments .....	65
To specify serial port settings.....	66

<b>Making Parallel Connections .....</b>	<b>66</b>
To connect a parallel device .....	66
To view or change parallel port assignments .....	67
<b>Making Infrared Connections .....</b>	<b>67</b>
To make an infrared connection .....	67
To print on an infrared printer .....	68
<b>7. USING THE DOCKING SYSTEM .....</b>	<b>69</b>
<b>Setting Up Your Docking System .....</b>	<b>69</b>
To set up the docking system .....	70
To dock the OmniBook .....	71
To undock your OmniBook .....	72
To install an ISA card .....	73
To install a PCI card .....	75
<b>8. TROUBLESHOOTING .....</b>	<b>77</b>
<b>Solving Problems .....</b>	<b>77</b>
Printing Problems .....	77
Memory Problems .....	78
Pointing Device and Mouse Problems .....	78
File, Drive, and PC Card Problems .....	79
Serial and Infrared Communications Problems .....	80
Sound Problems .....	81
Display Problems .....	81
Power and Startup Problems .....	81
Lockup Problems .....	84
<b>INDEX .....</b>	<b>ERROR! BOOKMARK NOT DEFINED.</b>

## Introduction

---

### Using This Online Manual

This online *User's Guide* looks similar to a printed manual—and it works like a printed manual in many ways, too. But you can do several handy things you can't do with a manual. For example, you can make the type larger or smaller. You can click pictures to enlarge them. You can add electronic bookmarks for marking key information. And you can print all or part of the manual on your printer.

- Press F1. You'll quickly see how to use this manual.

---

### Finding More Information

This OmniBook *User's Guide* introduces the OmniBook and shows you how to operate and maintain your OmniBook. For more information about using your OmniBook, look in these additional places:

- The *Introducing Microsoft Windows 95* manual, shipped with your OmniBook, contains information about using the standard features of Windows 95.
- The online Help for Windows applications provides information about those applications—use the Help menu or Help button, or just press F1.
- The OmniBook Notes icon gives late-breaking information available after the online manuals were completed—double-click the OmniBook Notes icon in Program Manager (in the OmniBook Library group).
- Many bookstores have books about Windows and MS-DOS for people with different levels of experience.

---

### Notice

This manual and any examples contained herein are provided “as is” and are subject to change without notice. Hewlett-Packard Company makes no warranty of any kind with regard to this manual, including, but not limited to, the implied warranties of merchantability and fitness for a particular purpose. Hewlett-Packard Co. shall not be liable for any errors or for incidental or consequential damages in connection with the furnishing, performance, or use of this manual or the examples herein.

Consumer transactions in Australia and the United Kingdom: The above disclaimers and limitations shall not apply to Consumer transactions in Australia and the United Kingdom and shall not affect the statutory rights of Consumers.

© Copyright Hewlett-Packard Company 1995–1996. All rights reserved.  
Reproduction, adaptation, or translation of this manual is prohibited without prior written permission of Hewlett-Packard Company, except as allowed under the copyright laws.

The programs that control this product are copyrighted and all rights are reserved. Reproduction, adaptation, or translation of those programs without prior written permission of Hewlett-Packard Co. is also prohibited.

Portions of the programs that control this product may also be copyrighted by Microsoft Corporation, Adaptec, Inc., Microcom Systems, Inc., SystemSoft Corp., and Chips & Technologies, Inc. See the individual programs for additional copyright notices.

Microsoft, MS, and MS-DOS are registered trademarks and Windows is a trademark of Microsoft Corporation (U.S. patent numbers 4955066 and 4974159). Carbon Copy is a trademark of Microcom Systems, Inc. SystemSoft is a registered trademark and CardWizard, CardView, CardSoft, and CardID are trademarks of SystemSoft Corporation.

For warranty information, see the *Support and Service* booklet.

Hewlett-Packard Company  
Mobile Computing Division  
1000 N.E. Circle Blvd.  
Corvallis, OR 97330, U.S.A.

Edition 1    March 1996

Edition 2    July 1996

# 1. Getting Comfortable

- [Identifying Parts of the OmniBook.](#)
- [Adjusting the Display.](#)
- [Using the Pointing Device.](#)
- [Using Sound.](#)
- [Using the OmniBook Keyboard.](#)
- [Learning About Windows.](#)

Congratulations! Your OmniBook sets a new standard in personal computing. Although it's compact and easy to carry, the OmniBook is equipped with a full-size keyboard, and a built-in CD-ROM or floppy drive.

This chapter introduces the OmniBook and helps you get familiar with your new computer.

---

## Identifying Parts of the OmniBook

The illustrations below point out key parts of the OmniBook.

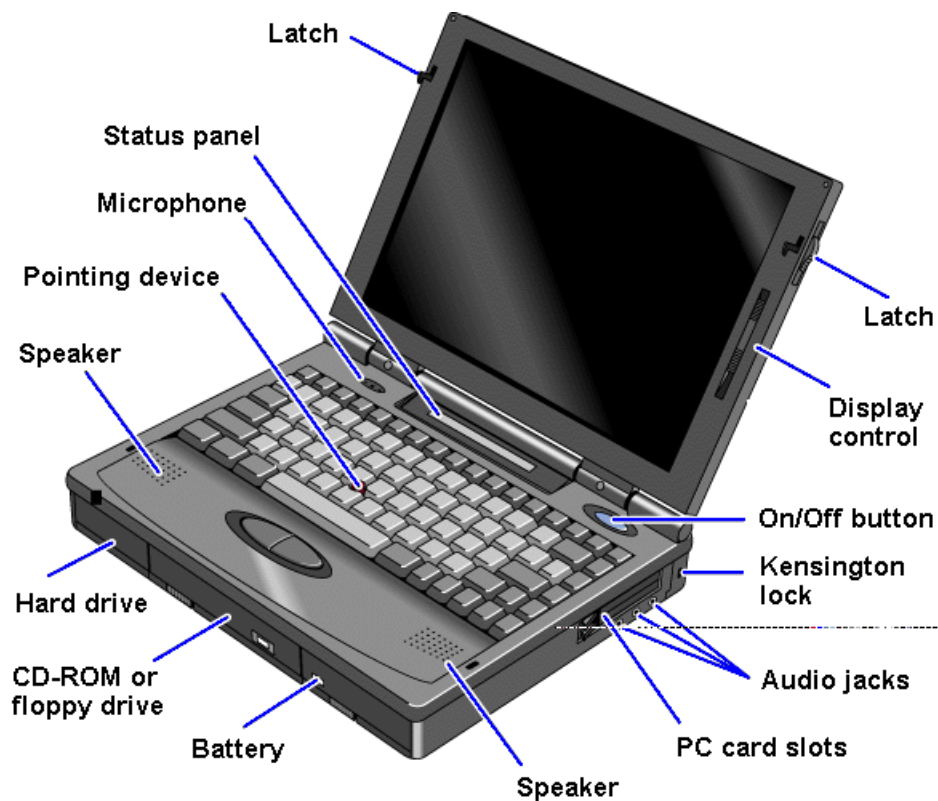

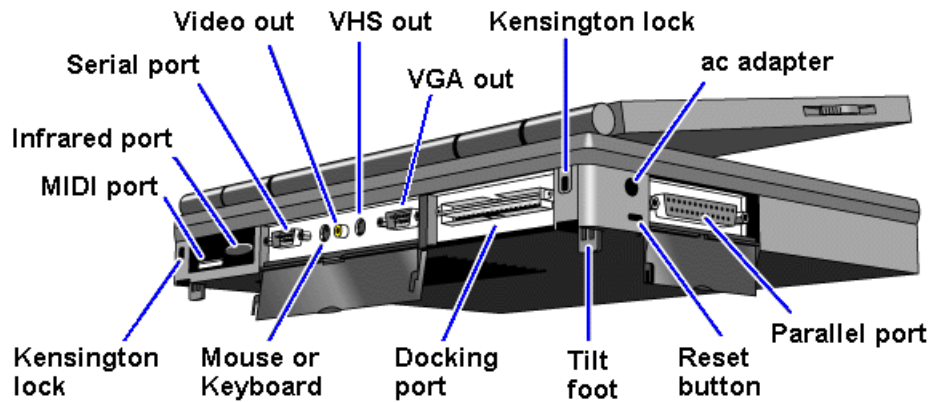

Depending on the accessories you purchased with your OmniBook, the center drive bay can hold an internal CD-ROM drive, a floppy disk drive, or a high-capacity battery for extra battery power. Alternatively, you can connect the floppy drive to the OmniBook externally.

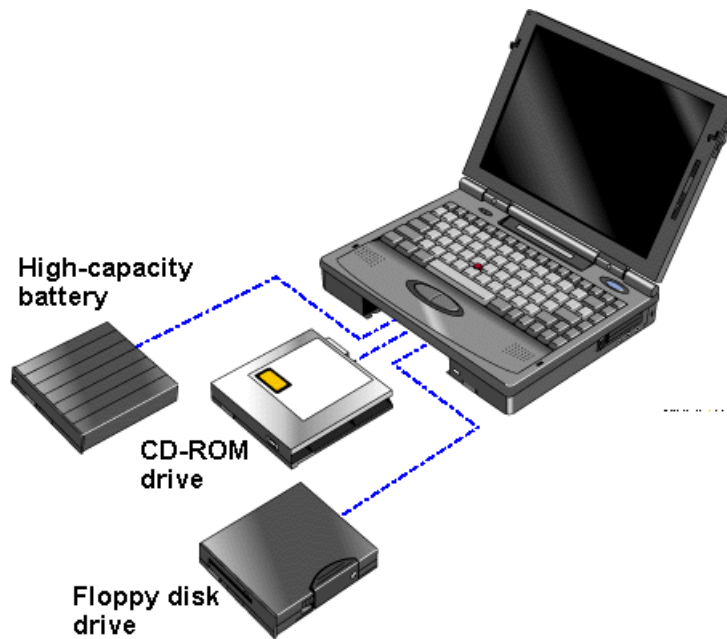



---

**Note**

To connect the floppy drive to the OmniBook externally, pull out the floppy drive cable and connect it to the parallel port.

---

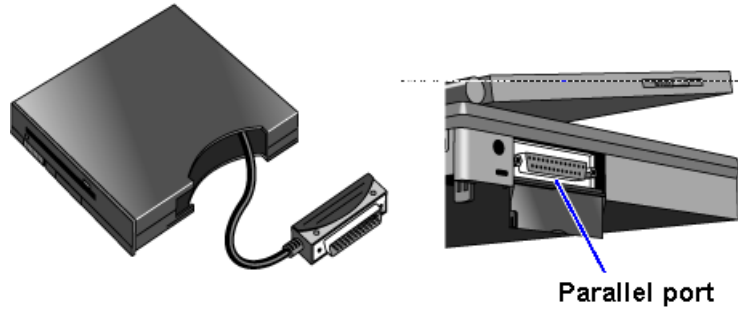



---

## Adjusting the Display

- All OmniBooks are equipped with a brightness control. ☀
- Some models also have a contrast control. ⓘ

In this section you'll learn how to

- [Locate the display controls.](#)
- [Adjust the display.](#)

### To locate the display controls

Your OmniBook display controls are located either to the right of the display or under the display. If you have two controls, the upper slider controls the brightness, and the lower slider controls the contrast.

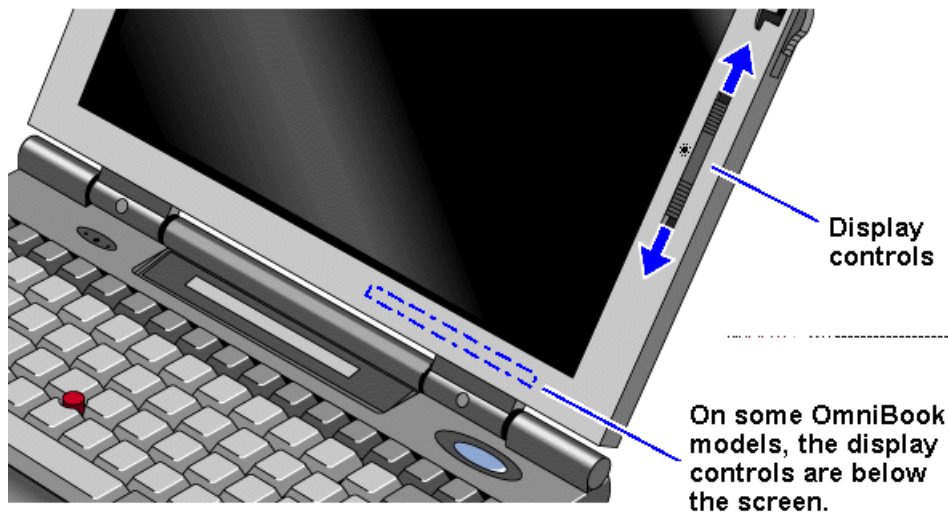

### To adjust the display

- Slide the control up to increase the brightness or contrast, and slide the control down to decrease it.

If your controls appear under the screen, slide right to increase brightness or contrast, and slide left to decrease it.

---

### Hint

Keep in mind that a higher brightness setting gives a shorter battery operating time—because the internal light is using more power. (The contrast setting doesn't affect the operating time.)

---

---

## Using the Pointing Device

The pointing device is positioned in the center of the keyboard and the two click buttons are positioned below the keyboard.

The pointing device controls the motion of the cursor on the screen by detecting pressure. The pointing device itself does not move. The cursor speed corresponds to the amount of pressure. The click buttons work like those on a standard mouse—what they do depends on the software that is used.

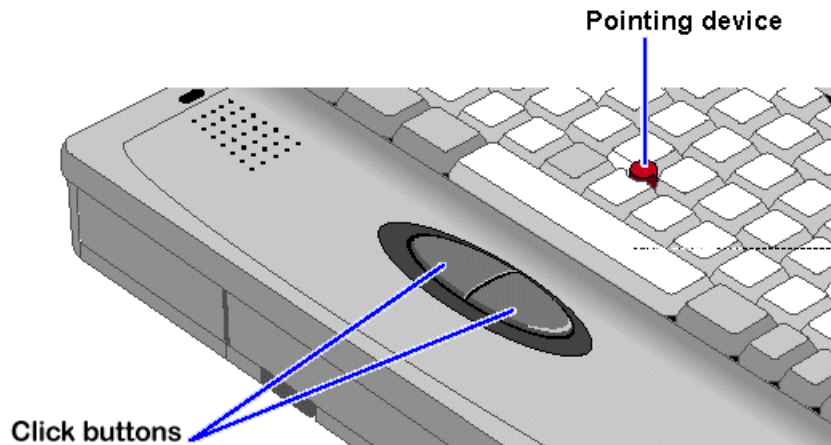

In this section you'll learn how to

- [Use the pointing device.](#)
- [Clean the pointing device cap.](#)
- [Customize the pointing device.](#)

### To use the pointing device

1. Place your hands in the typing position.
2. With your index finger, press the pointing device in the direction you want the pointer to move.
3. Pressing the pointing device away from you moves the cursor up the screen and pressing it toward you moves the cursor down the screen.
4. Click the buttons with your thumb to select and drag.

### To clean the pointing device

The cap on the end of the pointing device is removable.

- To maintain a smooth pointing operation, occasionally remove the cap and clean it with a soft moistened cloth. When the cap wears out, you can replace it with one of the spares shipped with your OmniBook.

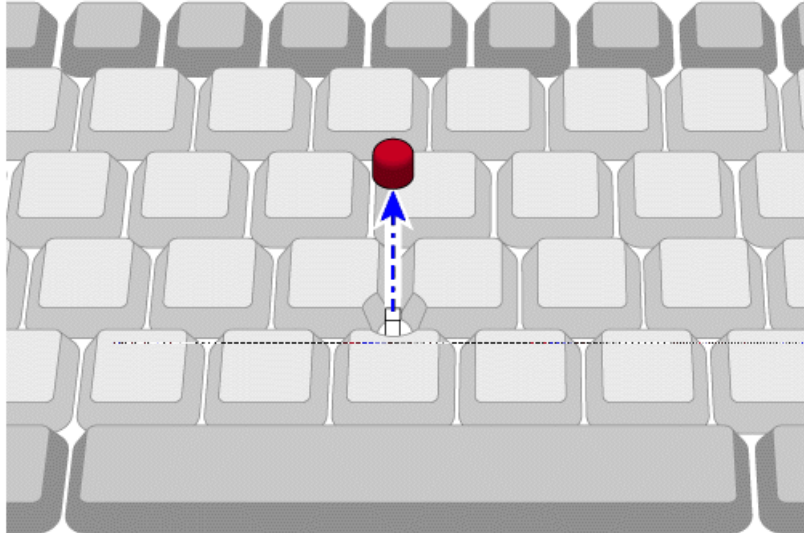

### To customize the pointing device

The following changes apply to the built-in pointing device—or an external mouse, if you've enabled one. If you connect an external PS/2 mouse, it disables the pointing device.

1. Click Start, then Settings.
2. Open the Control Panel.
3. Double-click the Mouse icon to open the Mouse Properties box.

The tabs at the top of the Mouse Properties box let you

- Swap the left and right buttons.
- Change the appearance of the pointing device.
- Change the response speed of the pointing device.
- Change the type of mouse used.

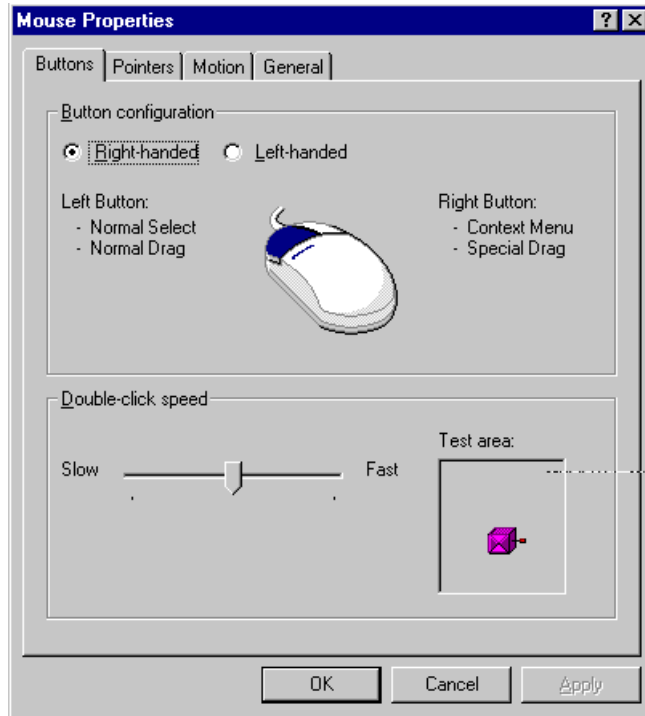

4. Click the setting you want, then click OK.

–or–

If you want to select more than one setting, click Apply after each.

---

## Using Sound

All OmniBook 5500 models support Sound Blaster compatible sound.

In this section you'll learn how to

- [Adjust the speaker volume.](#)
- [Connect a microphone, speakers, or headphones.](#)
- [Record sound.](#)
- [Play sound.](#)

### To adjust the speaker volume

- Hold down FN and press F8 or F9 as needed to gradually increase or decrease the maximum volume.

–or–

1. Click the speaker symbol in the taskbar.



2. Drag the volume control up to increase the volume or down to decrease the volume.

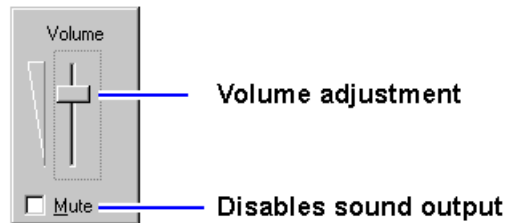

To temporarily silence the speaker output without changing the volume setting, click Mute in the Volume window. You can use the other controls in Volume-Mixer Control to control the volumes of individual sound sources—see [“To record sound”](#) and [“To play sound”](#).

---

### **Important**

When you adjust the volume using the Fn+F8 or Fn+F9 key combinations, you are adjusting the current volume and you are also setting the maximum volume that can be played in Windows. If the volume in Windows is too low, you may want to adjust it with the FN keys.

---

### **To connect a microphone, speakers, or headphones**

Your OmniBook has a built-in microphone above the keyboard and two stereo speakers.

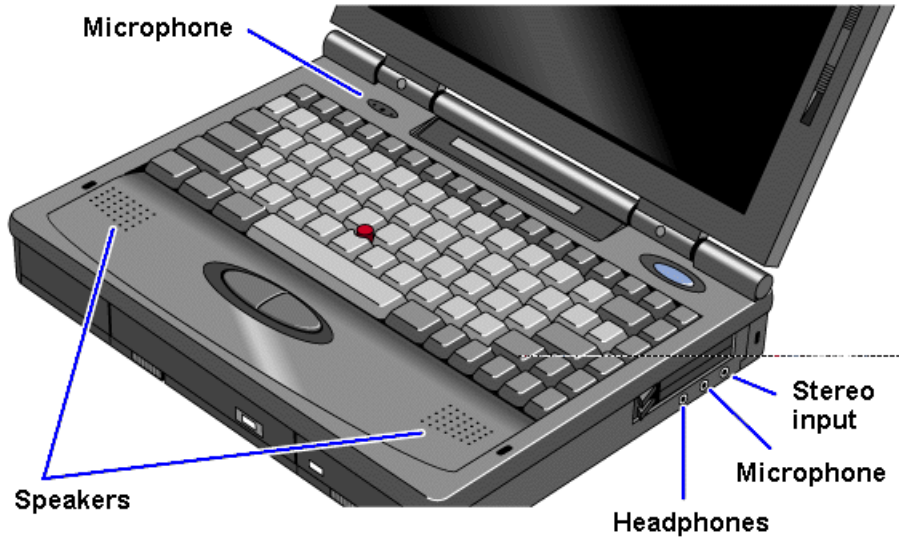

You can also plug in an external microphone, external speakers or headphones, and a stereo input source—such as a CD player.

- Plug the microphone into the microphone jack—the built-in microphone turns off.
- Plug the stereo speakers or headphones into the output jack—the built-in speakers turn off.
- Plug a stereo input source into the input jack.

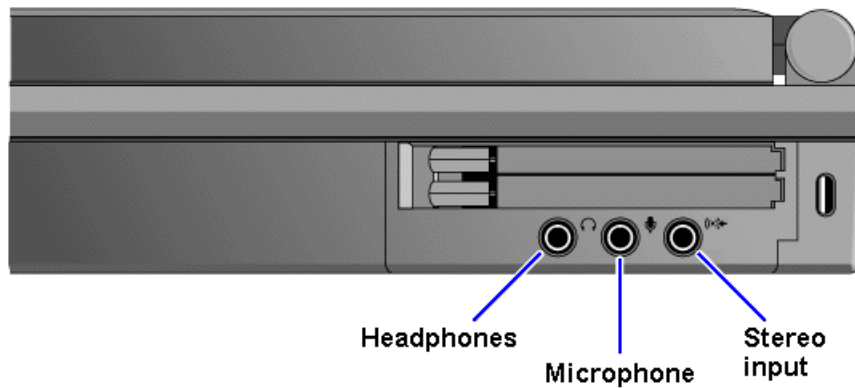

## To record sound

The OmniBook contains a built-in microphone for recording sound. You can also connect an external microphone in the built-in microphone jack.

1. Click Start, Programs, Accessories, Multimedia, Sound Recorder.

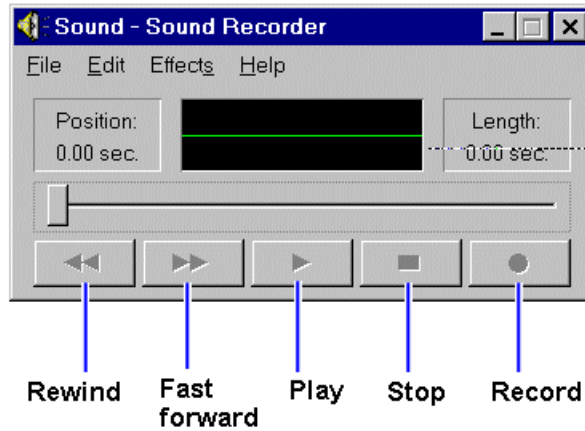

2. Click the Record button and speak into the microphone.
3. When finished, click Stop.

### To play sound

- To play back the sound you recorded, simply press the rewind button, then press the Play button.  
If you cannot hear the recording, you can increase the volume from the Effects menu.
- To play back an existing sound file, open the file, then press the Play button.

---

## Using the OmniBook Keyboard

You can tilt the OmniBook keyboard to a more comfortable typing angle with the built-in tilt feet located on the bottom of the OmniBook.

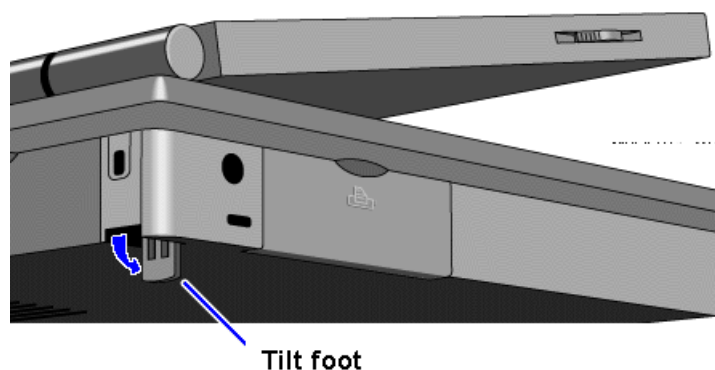

### To use special features of the OmniBook keyboard

In addition to the standard typing keys, the OmniBook keyboard contains the following special keys and features:

### Fn combination keys

Use the gold FN key in combination with other keys to execute special functions—for example, FN+F8 decreases the speaker volume. You press *and hold* the FN key, then you press the other key.

### Embedded numeric keypad

Press the NUM LOCK (number lock) key to use the numeric keypad. With the keypad active, keys change to the designations shown on their slanted faces.



### ALT GR key

If your keyboard has an ALT GR key to the right of the spacebar, you hold that key to type the characters printed at the bottom-right corners of keys. For keys that have four characters, hold SHIFT and ALT GR to type the upper-right characters.

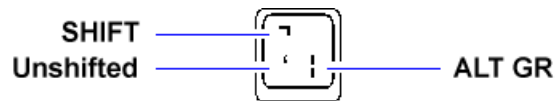

---

## Learning About Windows

### To learn about Windows

The OmniBook *User's Guide* introduces the OmniBook and shows you how to operate and maintain your OmniBook. For information about Windows, see the following sources.

- Start the 10-minute tour of Windows 95.  
Click Start, Programs, OmniBook Library, Tour of Windows 95.



- See the Windows online Help. Click Start, then Help.
- See the Introducing Microsoft Windows 95 manual shipped with your OmniBook.
- Many bookstores have books about Windows for people with different levels of experience.

## 2. Operating the OmniBook

- [Checking the Status of the OmniBook.](#)
- [Turning the OmniBook On and Off.](#)
- [Restarting the OmniBook.](#)
- [Using Storage Devices.](#)
- [Upgrading the OmniBook.](#)
- [Restoring OmniBook Files.](#)

Your OmniBook has been specifically designed for ease-of-use on the road. It features “instant-on” power that immediately restores your last screen. Advanced Power Management (APM) helps to minimize the amount of power you need to run your programs. And the OmniBook supports a wide variety of storage devices—all infused with the quality and the attention to detail that are the hallmarks of Hewlett-Packard.

---



### Checking the Status of the OmniBook

The OmniBook status panel, located above the keyboard, contains indicators that show the current status of the OmniBook. There are three groups of icons on the status panel that indicate

- [Keyboard status.](#)
- [Data storage status.](#)
- [Power status.](#)

#### To check keyboard status





The icons on the right indicate Caps Lock, Num Lock, and Scroll Lock.

	Caps Lock	This icon appears when Caps Lock is active.
	Num Lock	This icon appears when Num Lock is active.
	Scroll Lock	This icon appears when Scroll Lock is active.

#### To check data storage status



The center icons indicate data storage areas—CD-ROM activity, floppy disk activity, hard disk activity, and PC card status.

	CD-ROM	This icon appears when the OmniBook is reading from the built-in CD-ROM drive.
---	--------	--

	Floppy disk	This icon appears when the OmniBook is reading or writing to the floppy disk drive.
	Hard disk	This icon appears when the OmniBook is reading or writing to drive C.
	PC card	This icon appears when you insert PC cards into the card slots. The two cards identify when one or two of the slots are occupied.
	Power off	This icon appears when the OmniBook is turned off; the “bookmark” icon reminds you that the state of the computer has been saved.

## To check power status

The left icons indicate power conditions—ac adapter use, battery status, charging status.

	ac power	This icon appears when the ac adapter is plugged in.
	Battery status	The shading of the battery symbol shows the approximate charge level of the battery relative to a full charge.
	Battery charging	The lightning bolt symbol appears when the battery is charging. The battery symbol blinks when the battery is low.

The Windows 95 taskbar also shows status information about ac power or battery use, sound, infrared, and PC card use. The indicators shown vary depending on the current state of the OmniBook—whether a PC card is present or whether ac power is connected, for example.



Some of the taskbar indicators provide information or control when you move the mouse pointer over the indicator—or when you click the indicator (or double-click, or right-click). For example, double-click the battery icon to find out how much battery power remains.

---

## Turning the OmniBook On and Off

The OmniBook has several On/Off modes that save power when the ac adapter isn't connected. The most obvious of these is automatic shutdown—when your OmniBook has been idle for 3 minutes with no ac power, it turns itself off automatically.

In this section you'll learn how to:

- [Turn off the OmniBook \(Instant On mode\).](#)
- [Turn off the OmniBook \(Save-To-Disk mode\).](#)
- [Shut down the OmniBook.](#)

## To turn off the OmniBook (Instant On mode)

Use Instant On to temporarily turn off the OmniBook when you're away from it for short periods. In this mode, the OmniBook display turns off, but the computer saves the state of the computer in memory, exactly where you were working.

- Press the blue On/Off button.



The bookmark icon appears in the status panel when the OmniBook is in Instant On mode.

When you press On/Off again, the last screen displayed appears—there's no waiting through a lengthy reboot.

---

### Caution

**If you plan to leave the OmniBook in Instant On for a long period of time without ac power, be sure to *save your work* first.**

**If you are connected to a local area network (LAN), be sure to connect the ac adapter before you press the blue button. Without ac power, Instant On mode disconnects you from the LAN.**

---

## To turn off the OmniBook (Save-To-Disk mode)

Use Save-To-Disk to turn off the OmniBook when you're away from it for periods longer than a week. This mode saves the state of the OmniBook to the hard disk when you turn it off.

1. Unplug the ac adapter if it is connected and undock if docked.
2. Press FN+F12 to save to disk.

When you press On/Off to start the OmniBook again, the last screen displayed appears—ready for you to resume working.

## To shut down the OmniBook

In some situations, you may want to completely shut off the OmniBook so it reboots when you turn it on. For example, if you are using the OmniBook on a network, shutting down the OmniBook disconnects it from network resources.

1. **Important**  
Save your work.
2. Exit windows.
3. Press CTRL+ALT+blue On/Off button.

When you restart the OmniBook by pressing the blue On/Off button, the OmniBook reboots.

---

## Restarting the OmniBook

If an application has trouble starting or seems slow, you may need to close some documents or even exit some applications to make more memory available. If this doesn't fix the problem, you may need to reboot or reset the OmniBook.

In this section you'll learn how to

- [Reboot from the hard drive \(drive C\).](#)
- [Reboot from the floppy drive.](#)
- [Reset the OmniBook.](#)

### To reboot from drive C

Rebooting restarts the OmniBook software—your current work session is discarded and the operating system rereads the system files to determine the proper configuration.

1. Click Start, click Shut Down.

If the OmniBook floppy drive is installed, make sure there's no disk in the drive.

2. Click Restart the Computer, then click Yes.

If the OmniBook does not respond, try pressing CTRL+ALT+DEL. In certain situations, you may need to press the [reset](#) button.

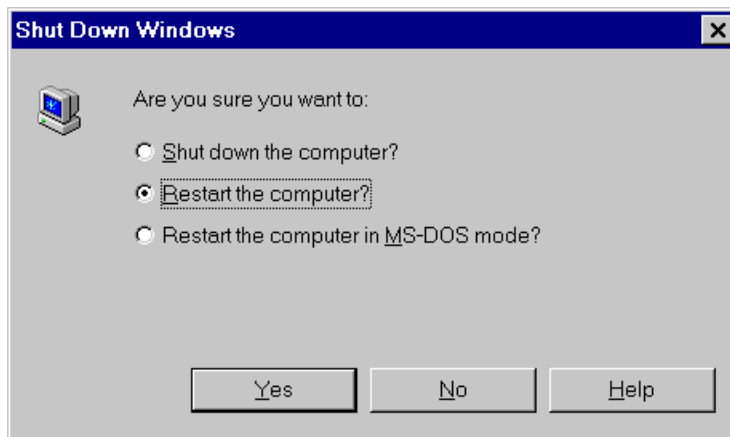

If your system doesn't reboot properly, you can reboot from the floppy drive using the *Support Utility* disk that came with the OmniBook. See ["To reboot from a floppy disk."](#)

### To reboot from a floppy disk

1. Install the OmniBook floppy drive. See ["To install the floppy drive."](#)
2. Insert a boot disk—you can use your *Support Utility* disk.
3. Press CTRL+ALT+DEL to reboot from the floppy disk.

## To reset the OmniBook

If the OmniBook unexpectedly hangs up in a state where nothing seems to work, you may need to reset it. When you reset the system, the OmniBook

- Discards your current work session.
  - Resets and checks the hardware.
  - Rereads the system files.
1. If the floppy drive is installed, make sure there's no disk in the drive.
  2. Insert a ball-point pen tip or other slender object into the small opening on the left side of the computer below the ac adapter socket. Push in momentarily—the system resets and reboots.

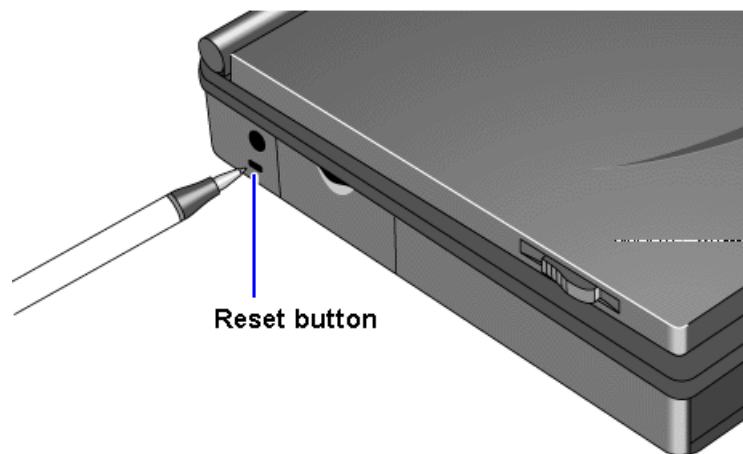

If the reset button has no effect, remove the battery and ac adapter and press the reset button—then install the battery or plug in the ac adapter and try pressing the reset button again.

---

## Using Storage Devices

Your OmniBook can access information in the following four places:

- The floppy disk drive—drive A (if present).
- The internal hard disk drive—drive C.
- The CD-ROM drive—drive D (if present).
- Two PC card slots—drives D and E (or drives E and F if a CD-ROM drive is present).

The PC card slots and the CD-ROM drive have higher drive letters when a SCSI hard drive is present—as with a docking system.

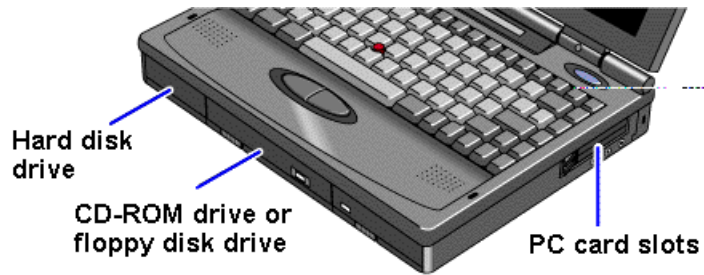

In this section you'll learn how to

- [Install a floppy disk drive.](#)
- [Remove the CD-ROM or floppy drive.](#)
- [Insert and remove a floppy disk.](#)
- [Install a CD-ROM drive.](#)
- [Insert and remove a CD.](#)
- [Insert a PC card.](#)
- [Remove a PC card.](#)

## To install the floppy drive

You can install the floppy drive or attach it externally to the parallel port.

1. If necessary, [remove the CD-ROM drive](#) (or super battery) from the OmniBook.
2. Slide the floppy drive into the OmniBook until it clicks into place.



–or–

- To connect the floppy drive to the OmniBook externally, pull out the floppy drive cable and connect it to the parallel port on the left side of the OmniBook.

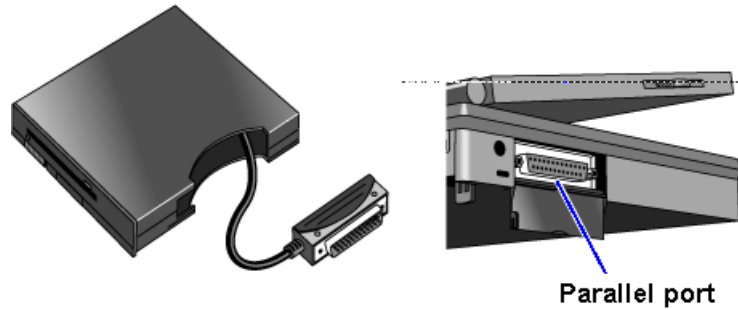

### To remove the CD-ROM or floppy drive

1. Slide the switch to the right. A pull-tab pops out.
2. Pull the pull-tab firmly to remove the CD-ROM or floppy drive from the OmniBook.
3. Push the pull-tab back into the drive after you remove the drive from the OmniBook.

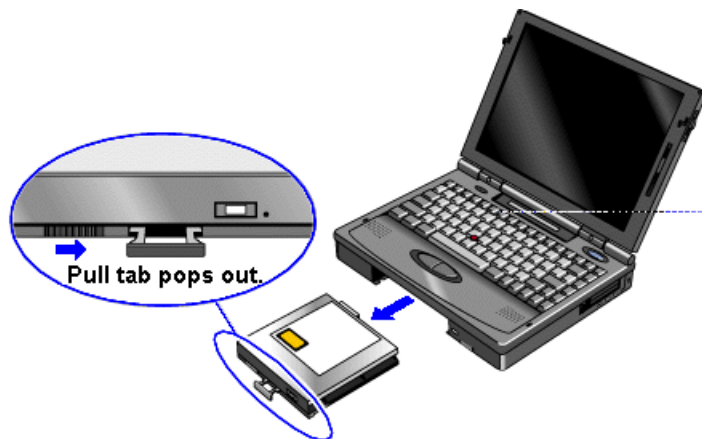

### To insert and eject a floppy disk

When the OmniBook is reading or writing data to the floppy drive, the floppy disk icon appears on the Status panel.



---

#### **Caution**

**Do not insert or remove a floppy disk while the OmniBook is actively reading or writing data. Wait until the floppy drive is done—otherwise, you could lose data or the OmniBook could stop responding.**

---



1. Hold the disk with its face up, then slide it into the floppy drive slot until it clicks into place.
2. To remove the floppy disk, press the eject button.

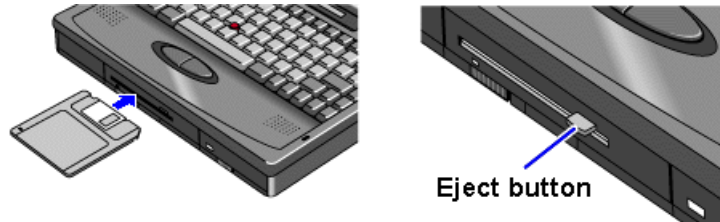

### To install the CD-ROM drive

1. If necessary, [remove the floppy drive](#) or super battery from the OmniBook.
2. Slide the CD-ROM drive into the OmniBook until it clicks into place.



### To insert and remove a CD

When the OmniBook is reading data from the CD-ROM drive, the CD disk icon appears on the Status panel.



---

#### **Caution**

**Do not insert or remove a CD while the OmniBook is actively reading data. Wait until the CD-ROM drive is done—otherwise, the OmniBook could stop responding.**

---

1. Press the open button on the front of the CD-ROM drive .

2. Place the CD in the drive and gently press down to seat it on the spindle.
3. Close the door to the drive.
4. To remove the CD, press the open button on the front of the CD-ROM drive.

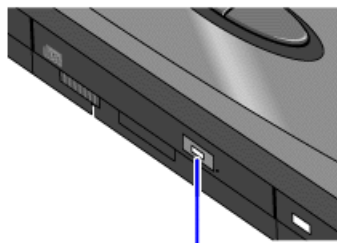

Press to open CD-ROM drive.



CD label up.

## To insert a PC card

The OmniBook PC card slots are available for devices that store data and expand the communication capabilities of the OmniBook. The OmniBook supports the following two kinds of plug-in PC cards:

- Data storage cards—cards that function as disks for storing data.
- Input/Output (I/O) cards—cards that typically provide external connections, such as modems and network cards.

The OmniBook works with type I, II, and III data storage cards such as Hewlett-Packard ATA-type hard disks and flash disks. You can use two thin cards or one thick card. If you have one thick card inserted, it is drive E. If you have two cards inserted, the upper card is drive E and the lower card is drive F.

For more information about compatible cards, contact Hewlett-Packard—see the *Support and Service* booklet.

---

### Caution

**Do not install Card Services or Socket Services software if it comes with your PC card. The OmniBook includes Card Services 2.1 and Socket Services 2.1, which automatically detect and set up PC cards you install in the upper and lower card slots. Different versions of this software will disrupt this support.**

**Never insert or remove a plug-in card while an OmniBook PC card drive is actively reading or writing data. Wait until the PC card drive is done—otherwise, you could lose data or the OmniBook could stop responding.**

---

The OmniBook card slots support standard version 2.1 Type I, II, and III PC cards. The computer automatically detects and sets up a card when you insert it in a card slot. A new data storage card may already be formatted and contain preinstalled software—check its instructions.

1. Hold the card with its face up and its connector holes toward the card slot, then slide it into a PC card slot until it won't go any further.

When the card is fully inserted, the PC card icon appears on the Status panel. A double beep signals that the card has been recognized and is successfully configured by your computer.



2. Inserting a card causes the slot's eject button to protrude from the case. You can rotate the button towards the front to make it flush with the case.

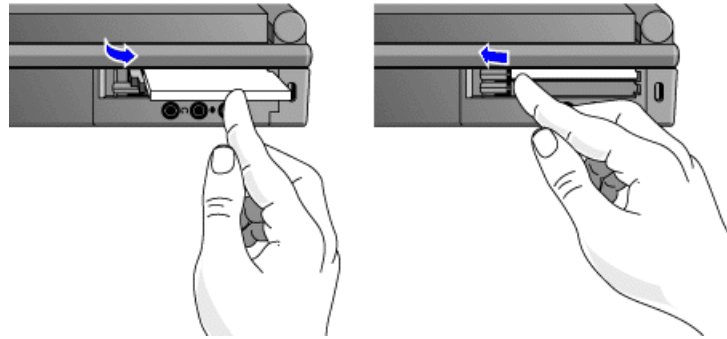

### About RAM Cards

If you're using a RAM card with the OmniBook, keep these suggestions in mind:

- For a new RAM card, install its battery before you insert the card.
- Replace the RAM card battery yearly.

When you want to replace a RAM card battery, plug the card into the OmniBook and make sure the OmniBook stays turned on while you replace the battery—you can plug in the ac adapter to keep it from turning off. Otherwise, the data on the card will be lost.

### To remove a PC card

---

#### Caution

**Never remove an I/O card while an application is open that's set up to use that card—exit the application first. If you remove the card, the application (or the OmniBook) might behave unpredictably or stop responding until you restart the OmniBook.**

**Never insert or remove a plug-in card while the PC card drive is actively reading or writing data. Wait until the PC card drive is done—otherwise, you could lose data or the OmniBook could stop responding.**

---

1. Click the PC card indicator in the taskbar, then click Stop.

This protects your data and avoids unexpected problems. You can restart the card by removing it, then inserting again.

2. If necessary, rotate the ejector button so that it protrudes from the case.
3. Press the black ejector button until the card pops out, then pull out the card.

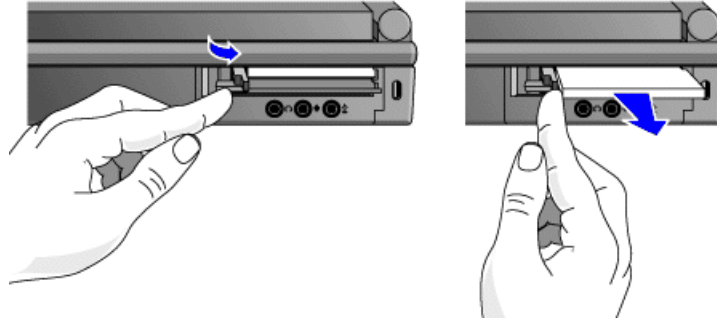

---

## Upgrading the OmniBook

You can upgrade or add to the OmniBook system by changing or installing certain components.

In this section you'll learn how to

- [Find your system software version and amount of memory.](#)
- [Add memory to the OmniBook.](#)
- [Remove the hard drive.](#)
- [Install a new hard drive.](#)

### To find the system software version and memory size

- Click Start, HP User Tools, Information 2, OmniBook System Information.  
The software version and amount of memory are displayed.

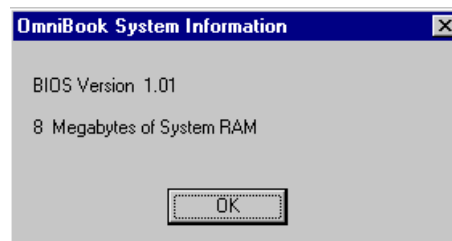

### To add memory to the OmniBook

The OmniBook memory slots accommodate two memory-expansion boards. You can install a memory-expansion board to increase the total amount of memory. To find out your OmniBook memory size, see [“To find the system software version and memory size.”](#)

---

#### Caution

**Take precautions against damage from static electricity: Gather all the parts you need so you can complete the installation in one sitting. Don't remove the**

memory-expansion board from its packaging until you've removed the slot cover from the OmniBook.

**When you remove the board from its packaging, hold it only by its edges. Don't touch the electronic components or gold traces. Also, turn off the unit, unplug the ac adapter, and remove the battery. Otherwise, the OmniBook or memory-expansion board may be damaged.**

---

1. Exit Windows—your current session and any data not saved will be lost.
  - If you're using Windows 95, use the shutdown option from the Start menu.
  - If you're using Windows for Workgroups, exit Windows, then press CTRL+ALT+blue On/Off button simultaneously.
2. Unplug the adapter.
3. Remove all batteries from the OmniBook.
4. Use your fingernail or a flat-blade screwdriver to remove the cover from the memory-expansion slot.
5. If a memory-expansion board is already present in both slots, pull out the board you want to replace. Use the tape tab to loosen the card from its connectors, then lift.
6. Position the memory-expansion board over the connectors and press in the board until it seats fully. Carefully check the shapes of the connectors to be sure the card is positioned properly.

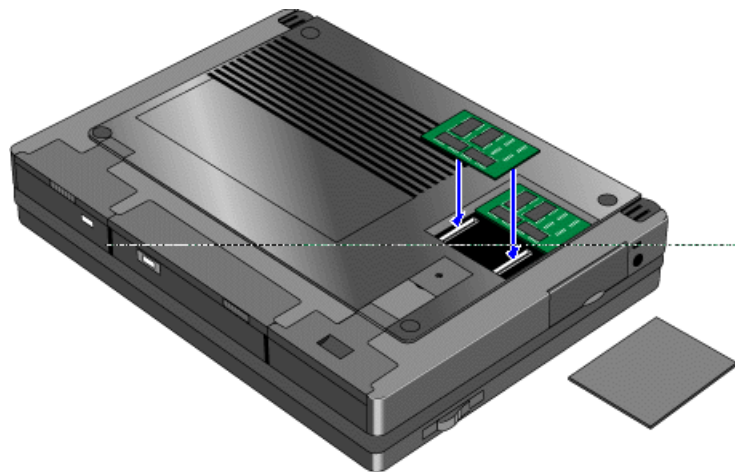

---

**Caution**

**Be careful not to press in the center of the board as this could crack it.**

---

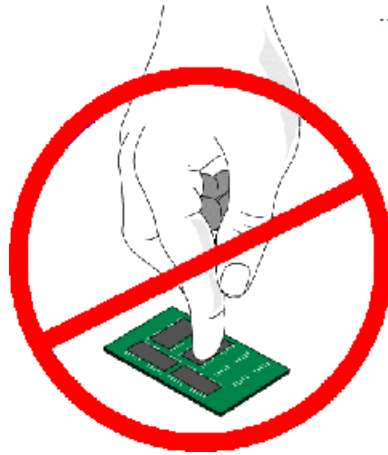

7. Replace the slot cover.
8. Insert the battery, then press the blue ON/OFF button.
9. When you see the following message:  
WARNING - UNEXPECTED AMOUNT OF MEMORY - RUN SCU  
press F2 to go to the System Configuration Utility.
10. Press ALT+X to open the SCU Exit menu.
11. Click Save and Exit to update the system configuration.

## To remove the hard drive

### 1. Important

Back up all the files on your current drive C. You can back up the files to a tape drive, a network drive, a PC card, or a flexible disk.

2. Unplug the adapter.
3. Exit Windows.
  - If you're using Windows 95, use the shutdown option from the Start menu.
  - If you're using Windows for Workgroups, exit Windows, then press CTRL+ALT+blue On/Off button simultaneously.
4. Remove all batteries from the OmniBook.
5. Close the cover and turn your computer over.
6. Remove the screw and security cover located at the back end of the hard disk drive.
7. Firmly slide the drive out of the drive compartment. (This requires some force.)

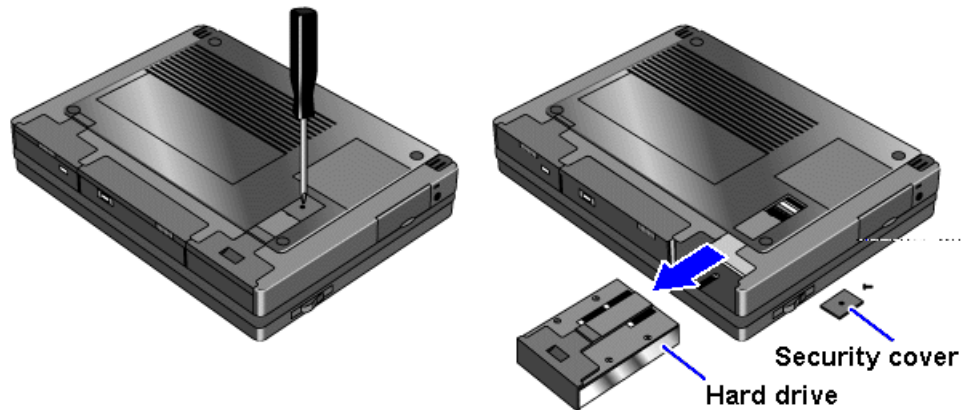

## To install the hard drive

After following the instructions for removing drive C, use the next procedure to install the new hard drive.

1. Gently press downwards on the hard drive while you slide it into the drive bay.
2. Make sure the drive is fully inserted.
3. Replace the screw and security cover.
4. Replace the battery or attach ac power.
5. Press the reset button.

---

## Restoring Files

Your OmniBook package includes a *Recovery CD ROM* and a *Support Utilities* floppy disk.

In this section you'll learn how to

- [Recover the Windows 95 operating system.](#)
- [Modify the Support Utility Disk to setup a PCMCIA or parallel port CD-ROM drive.](#)
- [Recover the Windows for Workgroups and MS-DOS 6.22 operating systems.](#)
- [Make backup disks for Windows for Workgroups and MS-DOS 6.22.](#)
- [Recover individual software applications—such as the Appointment Book and the online User's Guide.](#)
- [Read the online manual from the CD.](#)
- [Access device drivers for various operating systems and networks.](#)

## To recover Windows 95

The following procedure describes how to restore Windows 95 and your original OmniBook software. *These steps will format the hard drive. Back up any files you would like to save.*

The entire recovery process takes approximately 1 hour. To recover your Windows 95 operating system, you'll need a CD-ROM drive, floppy disk drive, the Recovery CD, and the Support Utility disk.

1. **If you have an internal CD-ROM drive**, connect the floppy disk drive to the OmniBook's parallel port and install the CD-ROM drive in the OmniBook.

–or–

**If you have a SCSI CD-ROM drive and a docking system**, connect the SCSI CD-ROM drive to the docking system and install the floppy disk drive in the OmniBook.

–or–

**If you have a PCMCIA or Parallel Port CD-ROM drive**, connect the PCMCIA or Parallel CD-ROM drive and install the floppy disk drive in the OmniBook. See ["To set up a PCMCIA or parallel port CD-ROM drive."](#)

2. Connect the ac adapter to the OmniBook.
3. Insert the *Recovery CD* in the CD-ROM drive.
4. Insert the *Support Utility* disk in the floppy disk drive.
5. Press the reset button.

The DOS 6.22 Startup menu appears.

6. Choose option 2:

#### **Recover Windows 95 from Recovery CD**

7. Choose the type of CD-ROM drive you're using—internal OmniBook, SCSI with docking system, or PCMCIA or parallel port.

*Do not interrupt the recovery process or unplug the ac adapter until recovery is completed.*

## **To set up a PCMCIA or parallel port CD-ROM drive**

The general steps for setting up a PCMCIA CD-ROM drive are as follows:

1. Copy the device drivers—from the installation software provided with the CD-ROM drive—to the HP Support Utility Disk into the **A:\tools** directory.
2. Add the **device=driver** statements to the **CONFIG.SYS** file on the Support Utility disk. The device statements should immediately follow the [USERCD] label.
3. Check the **AUTOEXEC.BAT** file to make sure that the CD-ROM drive is assigned as **drive G:**.

Before the OmniBook can recognize the CD-ROM drive, you'll need to edit the CONFIG.SYS and AUTOEXEC.BAT files on the Support Utility disk. The required device-drivers statements come from the CD-ROM manufacturer.

### **What you'll need from your CD-ROM manufacturer**

1. The names of the device drivers to copy to the Support Utility disk.
2. The device=drivers statements to add the CONFIG.SYS file.



3. Statements that the CD-ROM drive that *may* require to be added to the AUTOEXEC.BAT file.

---

## Hint

Both the CONFIG.SYS and AUTOEXEC.BAT files contain comments that should help your CD-ROM manufacturer advise you in editing the files to meet the particular requirements for your device.

---

## To recover Windows for Workgroups

The following procedure describes how to restore Windows for Workgroups and your original OmniBook software.

The entire recovery process takes approximately 1 hour. To recover your Windows for Workgroups operating system, you'll need a CD-ROM drive, floppy disk drive, your Windows for Workgroups backup disks, your MS-DOS 6.22 backup disks, the Recovery CD, and the Support Utility disk. If you don't have backup disks, you can make them—see ["To make DOS 6.22 and Windows for Workgroups backup."](#)

1. **If you have an internal CD-ROM drive**, connect the floppy disk drive to the OmniBook's parallel port and install the CD-ROM drive in the OmniBook.  
—or—  
**If you have a SCSI CD-ROM drive and a docking system**, connect the SCSI CD-ROM drive to the docking system and install the floppy disk drive in the OmniBook.  
—or—  
**If you have a PCMCIA or parallel port CD-ROM drive**, connect the PCMCIA or Parallel CD-ROM drive and install the floppy disk drive in the OmniBook. See ["To set up a PCMCIA or parallel port CD-ROM drive."](#)
2. Connect the ac adapter to the OmniBook (and the docking system if you're using one).
3. Insert MS-DOS disk #1 into the floppy drive.
4. Press the reset button.
5. Press F3 twice at the Welcome to Setup screen to return to the DOS prompt.
6. Type FORMAT C: /U to format drive C.
7. Press Ctrl+Alt+Del to reboot the OmniBook and continue with the MS-DOS 6.22 installation.  
  
When prompted for installation choices, choose the defaults.
8. When the MS-DOS installation is complete, insert disk 4 of the DOS disks and type A:. This is the MS-DOS Supplemental disk.
9. Type SETUP C:\DOS to install the MS-DOS Supplemental files.
10. Install Windows for Workgroups (from back-up installation disks or from purchased software) to drive C as follows:
  - Insert disk #1 and type **A:SETUP**.
  - Choose **Express Setup**.

- Select all defaults for this installation. *Do not install any printers or networks.* Install them after the rest of this installation is complete.
11. Insert the Recovery CD in the CD-ROM drive.
  12. Insert the Support Utility disk in the floppy disk drive.
  13. Press the reset button.  
The DOS 6.22 Startup menu appears.
  14. Choose option 3:  
**Recover Windows for Workgroups drivers and HP Application Software**
  15. Choose the type of CD-ROM drive you're using: internal OmniBook, SCSI with docking system, or PCMCIA or parallel port.  
*Do not interrupt the recovery process or unplug the ac adapter until recovery is completed.*

### To make DOS 6.22 and Windows for Workgroups backup disks

When you set up the Windows for Workgroups operating system, you should have been prompted to create a set of backup disks for Windows for Workgroups and DOS 6.22. If you did not make backup disks, you can do so now with the following procedure.

- From the OmniBook group, double-click Make Backup Installation Disks.  
Follow the instructions on the screen.

### To recover HP software programs

1. **If you have an internal CD-ROM drive**, install it in the OmniBook.  
–or–  
**If you have a SCSI CD-ROM drive and a docking system**, connect the SCSI CD-ROM drive to the docking system.  
–or–  
**If you have a PCMCIA or parallel port CD-ROM drive**, connect the PCMCIA or parallel port CD-ROM drive. See ["To set up a PCMCIA or parallel port CD-ROM drive."](#)
2. Insert the *Recovery CD* in the CD-ROM drive.
3. From the `\omnibook\hputils\disk1` directory on the CD, double-click **setup.exe**.  
The OmniBook Application Software Setup menu appears.

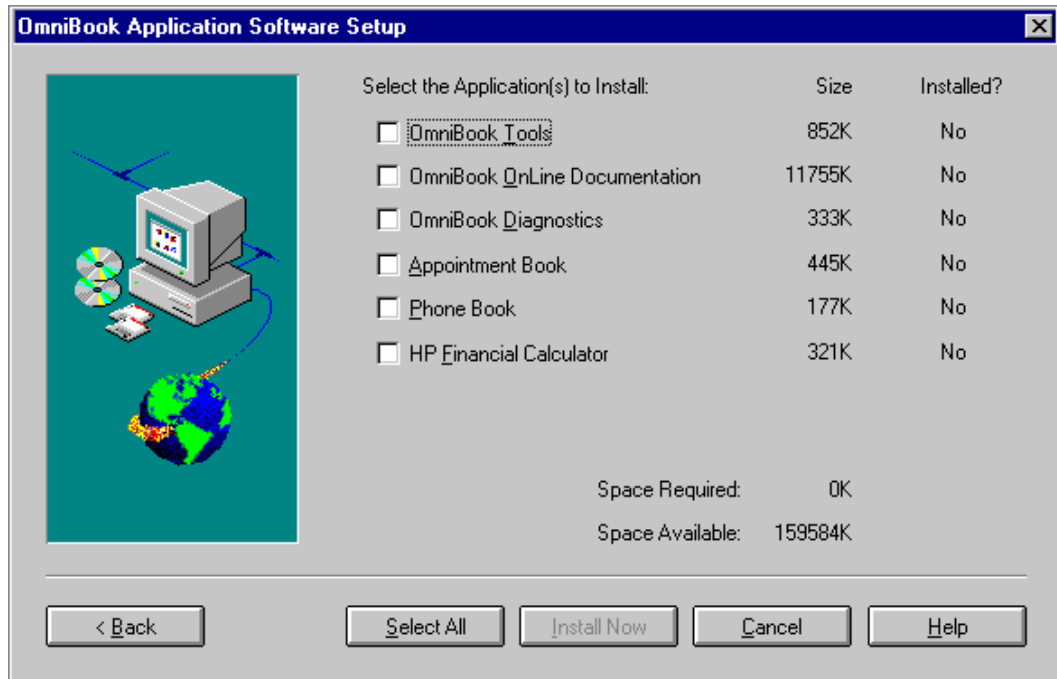

4. Click the HP applications you'd like to install.

–or–

Click Select All to install all of the HP applications.

5. Choose Install Now.

## To read the online User's Guide

If you want to save OmniBook disk space, you have the option of reading the online User's Guide directly from the Recovery CD.

1. **If you have an internal CD-ROM drive**, install it in the OmniBook.

–or–

**If you have a SCSI CD-ROM drive and a docking system**, connect the SCSI CD-ROM drive to the docking system.

–or–

**If you have a PCMCIA or parallel port CD-ROM drive**, connect the PCMCIA or parallel port CD-ROM drive. See ["To set up a PCMCIA or parallel port CD-ROM drive."](#)

2. Insert the *Recovery CD* in the CD-ROM drive.

3. To read the Windows for Workgroups manual, double-click **hpbook.exe** from  
**\omnibook\manualslwfw**

4. To read the Windows 95 manual, double-click **hpbook.exe** from  
**\omnibook\manualslwin95**

## To install device drivers for other operating systems

If you've installed a commercial version of Windows 95, Windows for Workgroups, or an alternate operating system, you'll need to manually install the required drivers. The CD-ROM contains drivers for the following operating systems:

- Window for Workgroups.
- Windows 95.
- Windows NT.
- OS/2.
- Novell.

The drivers are located on the CD in the **\omnibook\drivers** directory.

HP publishes application notes that give current information about installing operating systems and special device drivers. They are available from several electronic support services, including the HP Mobile Computing Web site:

**<http://www.hp.com/go/omnibook>**

These same application notes are also available from these electronic support services:

- America Online  
**Keyword: HP**
- CompuServe Information Services  
**Command: GO HP**
- Hewlett-Packard Bulletin Board  
**(208) 344-1691**  
**(up to 14400 baud, 8, N, 1)**

### **Window for Workgroups Driver Installation**

In the Support area of the Web page, search for these OmniBook 5500 application note identifiers:

<b>Identifier</b>	<b>Subject</b>
bpi01114	Installing Windows for Workgroups
bpi01102	Power management drivers
bpi01115	CD-ROM drivers
bpi01116	PC card drivers
bpi01117	SCSI drivers
bpi01118	Sound drivers
bpi01119	Video drivers
bpi01120	Using Windows for Workgroups

### **Windows 95 Driver Installation**

In the Support area of the Web page, search for these OmniBook 5500 application note identifiers:

<b>Identifier</b>	<b>Subject</b>
bpi01107	Installing Windows 95
bpi01102	Power management drivers
bpi01108	CD-ROM drivers
bpi01109	Infrared drivers
bpi01110	PC card drivers
bpi01111	Sound drivers
bpi01112	Using Windows 95
bpi01113	Video drivers

### **Window NT Driver Installation**

In the Support area of the Web page, search for these OmniBook 5500 application note identifiers:

<b>Identifier</b>	<b>Subject</b>
bpi01093	Installing Windows NT
bpi01094	PC card drivers
bpi01095	Sound drivers
bpi01096	Using Windows NT
bpi01097	Video drivers

### **OS/2 Driver Installation**

In the Support area of the Web page, search for these OmniBook 5500 application note identifiers:

<b>Identifier</b>	<b>Subject</b>
bpi01098	Installing OS/2
bpi01099	PC card drivers
bpi01100	SCSI drivers
bpi01101	Using OS/2
bpi01103	Sound drivers
bpi01104	Video drivers

## **3. Managing Battery Power**

- [Recharging and Replacing Batteries.](#)
- [Monitoring Battery Power.](#)

The primary source of power for the OmniBook is its rechargeable battery. The OmniBook provides several safeguards so that you won't be surprised by a dead-battery condition—the status panel shows the remaining battery charge and built-in warnings are displayed for low-battery conditions.

To preserve your current work session, the OmniBook automatically turns off when the battery charge gets too low—your session continues when you plug in the ac adapter or insert a fresh battery.

---

## Recharging and Replacing Batteries

You can use the ac adapter to recharge the battery—or to run on ac power to preserve the battery. The OmniBook conserves power by using Advanced Power Management (APM), software that controls battery charging and power drain.

Data on any of the drives is not affected by a low battery—unless the battery runs down completely while writing data to the drive.

In this section you'll learn how to

- [Recharge the battery or run on ac power.](#)
- [Respond to a low-battery warning.](#)
- [Replace the battery.](#)
- [Install a second battery.](#)

### To recharge the battery or run on ac power

- Plug the power cord into the adapter, then into a grounded ac outlet.
- Insert the adapter plug into the socket on the left side of the OmniBook.

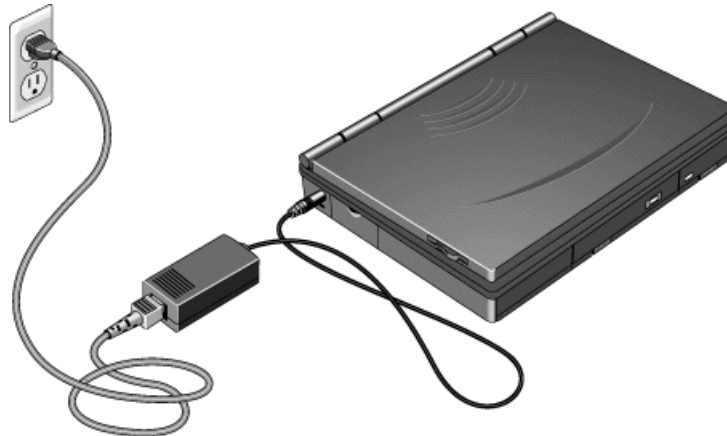

---

### Caution

Use only an HP F1044B ac adapter (the type shipped with the HP OmniBook 5500). *Using any other adapter could damage the OmniBook and void your warranty.* Always plug it into a grounded outlet. Note that the

**adapter plug has negative polarity—the inner contact is negative, and the outer is positive.**

---

The ac adapter is normally warm to the touch whenever it's plugged into an ac outlet. The OmniBook is normally warm while it's charging—don't charge it in a briefcase or other small space.

It's a good idea to use the ac adapter during operations that take more power—for example, those involving external connections, such as using a floppy drive or serial port.

The orange charging light on the battery turns on while the ac adapter is plugged in. When the light is on, the battery is less than 90% charged. The light turns off when the battery is more than 90% charged—or the ac adapter is unplugged.

---

### Hint

To get the longest battery operating time, allow the battery to charge fully—until the battery symbol in the status panel fills completely. Continued charging maintains the full charge.

You can continue working while the battery is charging, however, the battery will charge faster—up to 30% less time—if you turn off the computer.

---

## To respond to a low-battery warning

When battery power is critically low, the battery status indicator in the LCD status panel appears empty and starts to flash. The OmniBook automatically shuts off to preserve your current session as long as possible. You won't be able to turn it on again until you restore power by one of the following actions:

- Plug in the ac adapter. See [“To recharge the battery or run on ac power.”](#)
  - Replace the battery or install a second battery. See [“To replace the battery”](#) or [“To install a second battery.”](#)
- 

### Caution

**If you don't restore power and you don't save your work before the OmniBook turns itself off, your current session will be lost if the battery runs down completely—within as little as several hours after the warning.**

---

## To replace the battery

You may never need to remove the rechargeable battery in ordinary use—just connect the ac adapter to the OmniBook and recharge the battery while you work. However, you can replace a low battery with another that is more fully charged.

### 1. Important

Save your work.

2. If available, plug in the ac adapter.
3. Slide the battery switch to the right and slide the battery out of its compartment.
4. Slide the new battery all the way into the battery compartment.

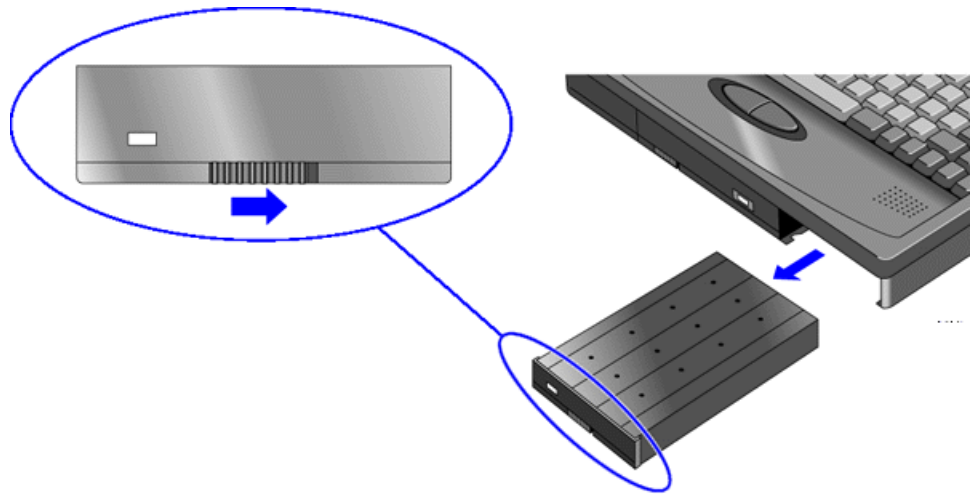



---

## Caution

Do not mutilate, puncture, or dispose of the battery in fire. The battery can burst or explode, releasing hazardous chemicals. A rechargeable battery pack must be recycled or disposed of properly.

---

## To install a second battery

To increase the time you can work on a battery, you can install a second, high-capacity battery in the floppy or CD-ROM drive bay.

### 1. Important

Save your work.

2. If necessary, [remove the floppy drive](#) or CD-ROM drive from the OmniBook.
3. Slide the high-capacity battery into the OmniBook until it clicks into place.

A second Battery Status icon appears in the LCD status panel, showing the charge level of the new battery.



---

## Monitoring Battery Power

The battery status indicator on the LCD status panel shows the approximate charge level of the battery graphically. For more detailed information, you can see the battery status in the Power dialog box.

In this section you'll learn how to

- [Get the battery status.](#)
- [Save battery power.](#)

- [Adjust the battery charging order.](#)
- [Change how power is managed.](#)

## To get the battery status

- Move the mouse pointer onto the battery indicator at the right end of the taskbar—the approximate battery time remaining is displayed in a pop-up window.



## To save battery power

To preserve your current work session, the OmniBook automatically turns off when the battery charge gets too low—your session continues when you plug in the ac adapter or insert a fresh battery.

You can follow these suggestions for conserving battery power.

- Plug in the ac adapter, especially while using the floppy drive, the CD-ROM drive, or any external connections.
- Turn down the brightness of the display to the lowest comfortable level—this reduces the backlight power, which can increase the battery operating time.
- Set power management to an option that emphasizes saving power—see [“To change how power is managed.”](#)
- If you work with an application that uses the serial port or an I/O card, exit the application when you’re done using it.
- If you access one or more files or programs on a hard disk or floppy disk frequently, consider copying or moving those files or programs to a flash disk or RAM card in the upper or lower card slot—at least while you’re using the files.
- If you have a PCMCIA I/O card—that is, a card having an external connection, such as a modem or network card—remove it when you’re not using it. Some I/O cards use significant power, even while they’re inactive.

## To adjust the battery charging order

If you have two batteries installed, you can specify the order in which they charge. Only one battery charges at a time.

### 1. **Important**

Save your work—you will be rebooting your OmniBook.

2. Press FN+F2 to start the System Configuration utility.
3. From the Power menu, select Battery Charging.
4. Select the battery charging order you want, and then select OK.
5. From the Exit menu, select Save And Reboot.

6. Select OK in the Save And Reboot dialog box.

## To change how power is managed

You can change power-management settings that affect power usage and performance. For ideas about how to save battery power, see [“To save battery power.”](#)

1. Click Start, HP User Tools, Setup, OmniBook, Power.
2. Select the power-management option that matches the balance you want between battery life and response time.

If you choose the Custom option, you can change the individual time-out settings, such as the automatic turn-off time. *The greater the idle time before turn off, the more battery power you will use.*

3. Click OK.

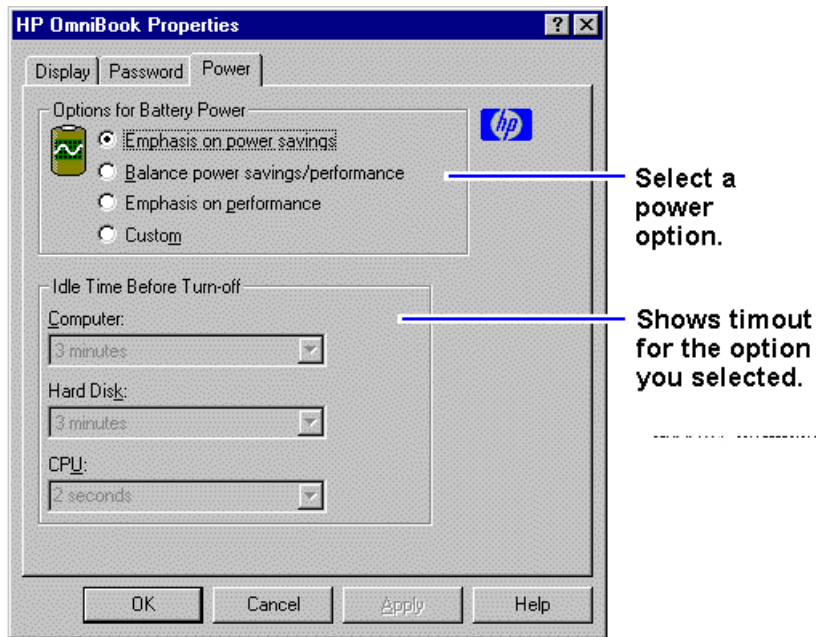

---

### Note

The OmniBook automatic turn-off feature operates only when the OmniBook is running on battery power. If the ac adapter is powering the unit, the OmniBook does not automatically turn off.

---

## 4. Protecting Your OmniBook

- [Attaching a Security Cable.](#)
- [Setting Up Password Protection.](#)
- [Protecting Your Data.](#)

Your OmniBook provides several ways for you to identify and protect your computer.

---

### Attaching a Security Cable

Your OmniBook has three built-in connectors that allow you to secure the OmniBook with a cable—two on the back of the computer and one on the right side. The Kensington lock systems work with these connectors and are available at many computer stores.

#### To attach a security cable

1. Wrap the cable around a stationary object, such as a table leg.
2. Loop the cable to create a slip knot around the stationary object—make sure it can't slip off.
3. Insert the lock into one of the OmniBook security connectors and release the key. *Store the key in a safe place away from the OmniBook.*

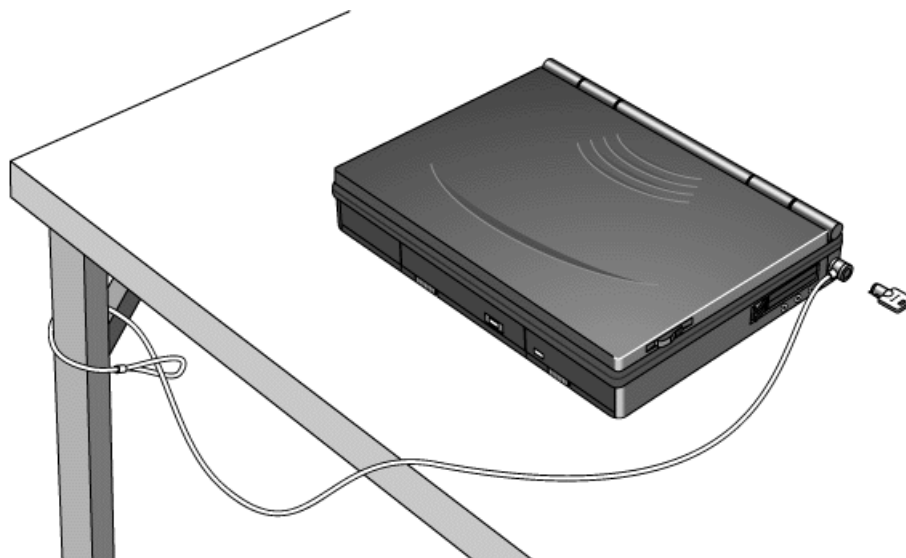

---

### Setting Up Password Protection

You can protect your OmniBook against unauthorized use by activating password security. You can create a user password for normal protection against unauthorized use. You can also create an administrator password for a system administrator or as

a backup for the user password—or your system administrator might set up this password.

In this section you'll learn how to

- [Record your name for identification purposes.](#)
- [Set up a user password.](#)
- [Delete a password.](#)
- [Set up an administrator password.](#)

## To record your name or other PC identification

By recording your name and other information, you identify your OmniBook and make a record of purchase information that will be handy if you have to contact Hewlett-Packard for support or service. Your personal information is displayed each time you reboot the OmniBook.

1. Click Start, HP User Tools, Advanced.
2. Click the PC Identification button.
3. Type your name or any other information, then click OK.

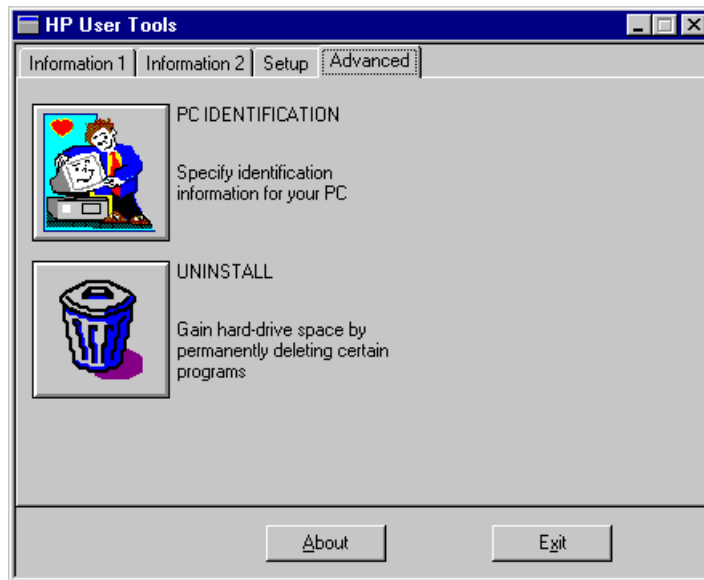

## To set up a user password

If you use password security, you must enter the password at certain times when you turn on the OmniBook. Your password protects your hard disk even if the hard disk is installed in another OmniBook.

1. Click Start, HP User Tools, Setup, OmniBook, Password.
2. Click Set User Password.

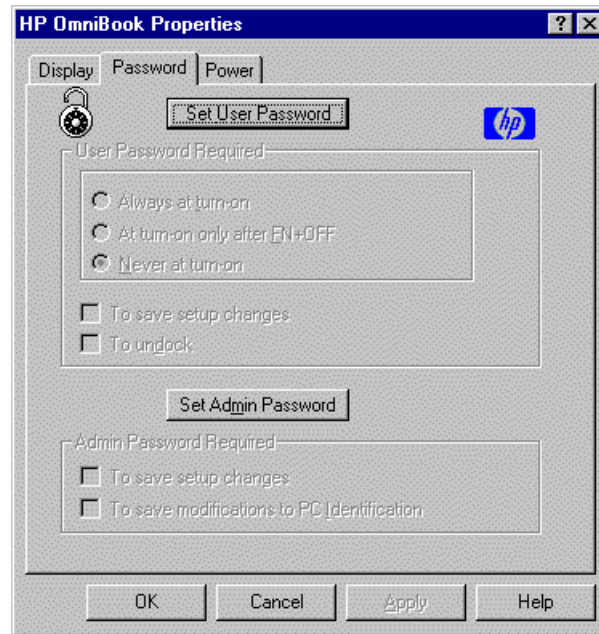

3. Type your new password—it can contain up to eight characters—then press TAB. The display shows \* for each character in your password.

---

### Hint

Before you type a password, check the status of Num Lock—normally, you'd want it off so you can type letters.

---

4. Type the new password again (in the Verify box), then click OK.
5. Select or clear the following password options you want.

#### **Never At Turn-On**

You do not need to enter your password when you turn on the OmniBook—even if it turned itself off after a period of inactivity.

#### **Always At Turn-On**

You must enter your password every time you turn on the OmniBook—even if it turned itself off after a period of inactivity.

#### **At Turn-On After FN+OFF**

The only time you must enter your password is when you turn on the OmniBook after you deliberately turned it off by pressing FN+On/Off. (If you turned it off with just On/Off, you're not prompted for your password.)

#### **To Undock**

You must enter your password each time you undock the OmniBook from a docking station.

#### **To Save Setup Changes**

You must enter your password every time you save changes in the System Configuration utility or OmniBook Tools.

6. Click OK to activate the changes.

---

## Caution

Be sure you record your password in a safe place. To restore operation if you forget your password, call Hewlett-Packard at the number in the *Support and Service* booklet.

---

## To delete a password

1. Click Start, HP User Tools, Setup, OmniBook, Password.
2. Click Set User Password or Set Admin Password—depending on which password you are deleting.

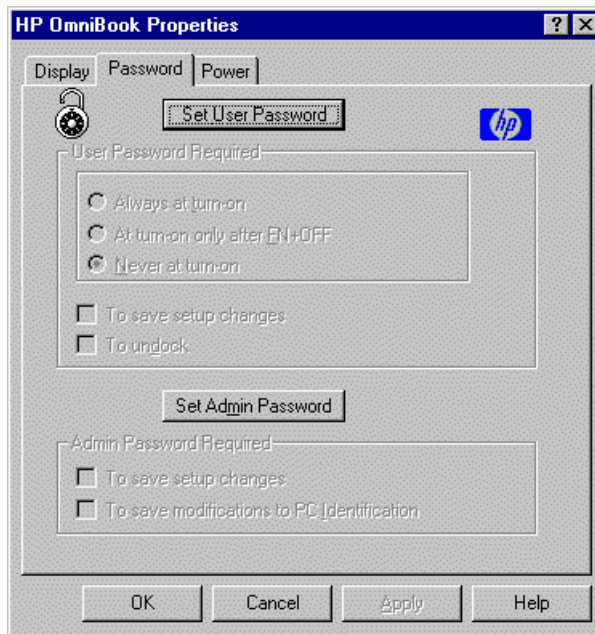

3. Type your old password.
4. Leave the New Password box empty, then click OK.

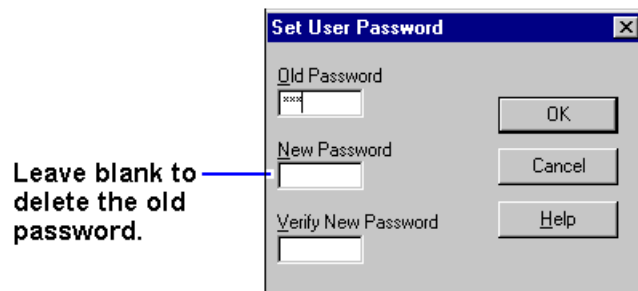

## To set up an administrator password

You can also set up an administrator password on your OmniBook. The administrator password can serve as a backup for the user password—you can enter

it any time the user password is requested—or you can use the administrator password to keep your PC identification and configuration secure.

1. Click Start, HP User Tools, Setup, OmniBook, Password.
2. Click the Set Admin Password button.

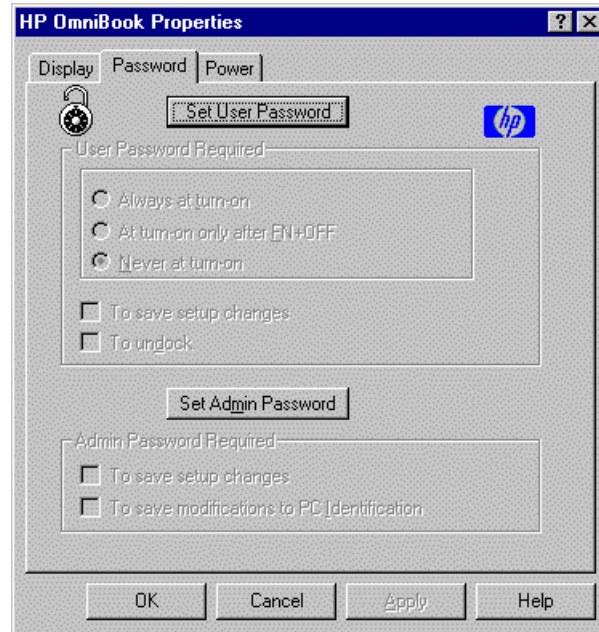

3. Type your new password—it can contain up to eight characters—then press TAB. The display shows \* for each character in your password.

---

### Hint

Before you type a password, check the status of Num Lock—normally, you'd want it off so you can type letters.

4. Type the new password again (in the Verify box), then click OK.
5. Select or clear the Administration Password options you want.

#### To Change PC Identification

You must enter your administrator password every time you save changes to the PC identification.

#### To Save Setup Changes

You must enter your administrator password every time you save changes in the System Configuration utility or OmniBook Tools.

6. Click OK to activate the changes.

---

### Hint

When moving a password-protected hard disk to another OmniBook, do one of the following:

- Remove password protection before transferring the hard disk to another OmniBook.



- Set the password of the new OmniBook to match the current password on your hard disk.
- 

## Protecting Your Data

As you create or add information on your OmniBook, the need to make backup copies of that information becomes more important. By making backup copies of key files, you can reduce the chance of accidentally losing that data. You can back up individual files to floppy disks using the Windows File Manager. For more elaborate backup storage, you might need to obtain one of the many commercially available software packages.

In this section you'll learn how to

- [Repair and clean up a disk.](#)
- [Delete a set of OmniBook files.](#)

### To repair and clean up a disk

After a period of use, the file structure on a disk may develop corrupted sections or disjointed files, causing errors or slightly longer response time in some situations. If you clean up the disk every few months or so, you can optimize your disk's operation.

---

#### **Caution**

**Back up your files periodically, especially before doing maintenance.**

---

1. Plug in the ac adapter.
2. Click Start, Programs, Accessories, System Tools, Disk Defragmenter to optimize the use of space on a disk.
3. Select the drive you want to defragment.
4. If Disk Defragmenter finds errors on the disk, you can click Start, Programs, Accessories, System Tools, ScanDisk to repair disk errors.

### To delete a set of OmniBook files

If you need to make more disk space available on drive C, you have the option of removing certain sets of OmniBook files. The files you can remove vary depending on the operating system you selected.

1. Click Start, HP User Tools, Advanced.
2. Click the Uninstall button.
3. Select the set of files you want to remove from your OmniBook.
4. Click Uninstall to delete the selected files.

–or–

Click Cancel to close the dialog box without deleting files.



## 5. The Personal Information Applications

- [Managing Your Time with Appointment Book.](#)
- [Finding People with the Phone Book.](#)
- [Getting Answers from HP Financial Calculator.](#)

This chapter introduces three applications to help you manage your day—meetings and appointments, addresses and telephone numbers, personal records and finances—to mention just a few.

---

### Managing Your Time with Appointment Book

Appointment Book in your OmniBook is the perfect replacement for that old pocket calendar or bulky scheduler you may have used in the past. Appointment Book helps allocate your time, and is as easy to use as other Windows applications.

In this section you'll learn how to

- [Start Appointment book.](#)
- [View appointments.](#)
- [Add an appointment.](#)
- [Add an event.](#)
- [Delete an appointment or event.](#)
- [Exit Appointment Book.](#)

#### To start Appointment Book

- Click Start, Programs, OmniBook, and Appointment Book.

#### To view your appointments

- Click the day, week, month, or year button on the toolbar.

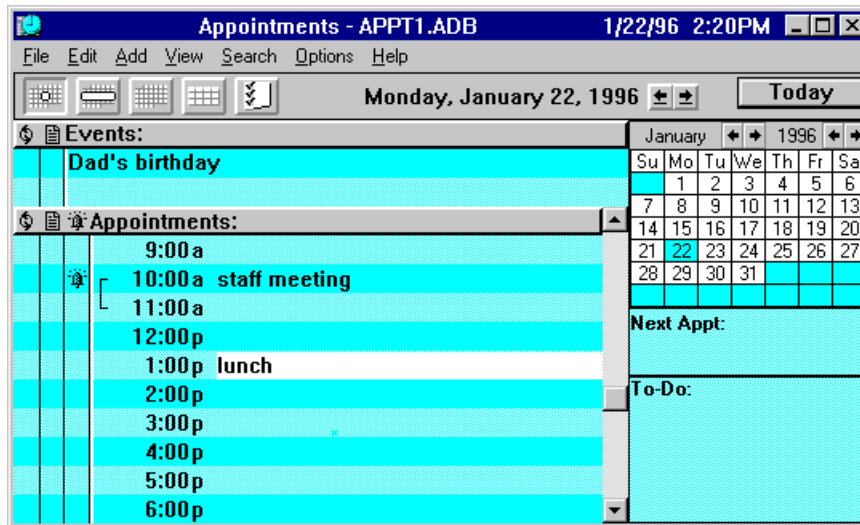

## To add a new appointment

1. If necessary, click the day in the Calendar to display the day of your new appointment.
2. Double-click the line next to the desired time in the Appointment area. The Add Appointment/Event box appears.
3. Type a description of the appointment.
4. Click OK to add the appointment and close the box.

—or—

If you want to add several appointments, click Save after each.

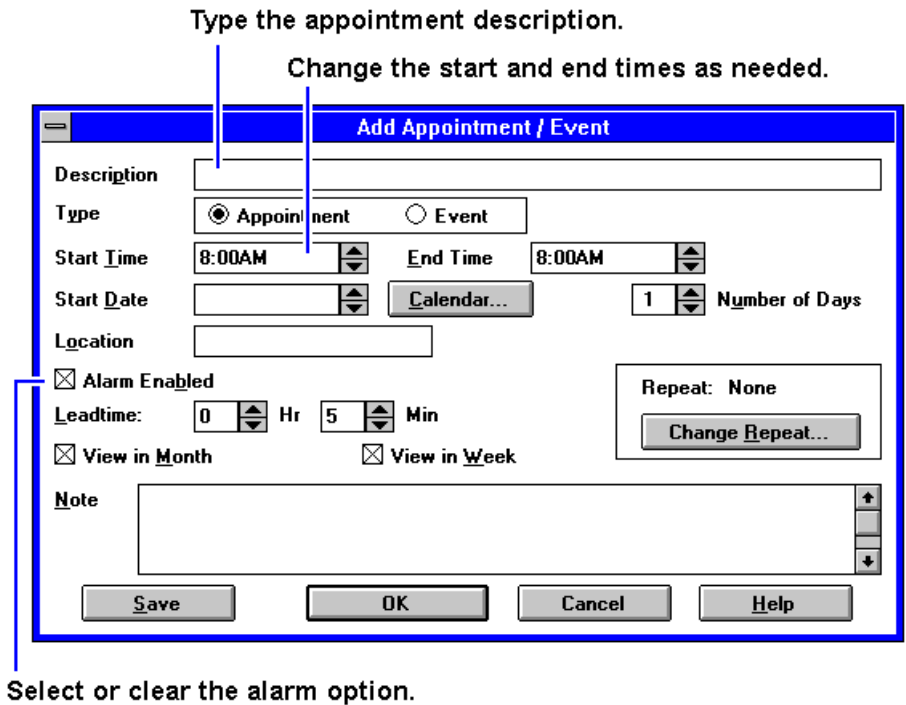

When the OmniBook signals an appointment, it displays a dialog box to signal the alarm, even if you have exited Appointment Book or are working in another application. If the OmniBook is off, it turns on to display the box and signal your alarm.

## To add a new event

Events (like holidays and anniversaries) are special days you don't want to forget.

1. If necessary, click the Day button to display and change to the day of your new event.
2. Double-click a blank line in the Event area. The Add Appointment/Event box appears.
3. Type a description of the event.
4. Click OK to add the event and close the box.

—or—

If you want to add several events, click Save after each.

## To delete an appointment or event

1. Click the appointment or event to move the highlight there.
2. Press DEL to delete the appointment or event.

Appointment Book saves every change to your schedule for you as you make it. So when you exit the Appointment Book application, you don't need to worry about saving changes first.

## To exit Appointment Book

Exit Appointment Book when you're not using it—or before you turn off your OmniBook. If the Appointment Book is open and your OmniBook has an unexpected problem, it could corrupt the current appointment file.

- From the File menu, click Exit.

---

## Finding People with the Phone Book

Phone Book is another valuable part of your portable OmniBook. It is actually a personal database containing names, addresses, and telephone numbers, all ready for handy reference. You can add entries, delete them, search for a specific name, or even search for specific text.

In this section you'll learn how to

- [Start Phone Book.](#)
- [Add a new name.](#)
- [Search for a name.](#)
- [Exit Phone Book.](#)

## To start Phone Book

- Click Start, Programs, OmniBook, and Phone Book.

## To add a name to the Phone Book

1. Double-click a blank line in the display area.

–or–

Press F2.

Type the last name first.

Names are sorted alphabetically.

2. In the Name box, type a person’s name—for example, “Martin, Jean-Claude.”

Remember to type the last name first, because when you sort or search the list of items, the operation begins by looking at the leftmost character. Putting last names first will make it easier to find people later.

3. Type information in the rest of the Add New Item box. Here are a few hints:

4. Click OK to enter the item into the list.

–or–

Click Save to enter the item into the list and open a new, blank item. This is a good way to add several items to the list, one after another.

When you add new persons to the list, they’re automatically placed in alphabetical order.

---

### Hints

- For ease of typing, you can use the TAB key to tab between fields. Press SHIFT+TAB to tab backwards.
  - The Category entry allows you to sort your list into sections for relatives, personal acquaintances, business contacts, and so on.
  - You can leave almost any field blank.
-

## To search for a name

When you start typing a name, Phone Book's Fast Goto dialog box pops up and searches as you type. The highlight moves to the name as you type it.

1. Type the first letters of the name you want to find.
2. When the highlight is on the name you want, press ENTER to close the Fast Goto dialog box.

## To exit Phone Book

Exit the Phone Book when you're not using it—or before you turn off your OmniBook. If the Phone Book is open and your OmniBook has an unexpected problem, it could corrupt the current Phone Book file.

- From the File menu, click Exit.

---

## Getting Answers from HP Financial Calculator

HP Financial Calculator gives you all the power and convenience of a full-fledged Hewlett-Packard calculator. It lets you quickly perform mathematical operations, as well as sophisticated financial and scientific calculations. Here's a sample of what you can do with this handy OmniBook application:

- Perform general arithmetic problems involving addition, subtraction, multiplication, and division.
- Execute sophisticated TVM (time value of money) and financial calculations.
- Produce analyses of financial alternatives.
- Do conversions involving currency, length, temperature, and other units.
- Perform calculations using scientific functions like sine, cosine, polar/rectangular functions, and more.
- Solve algebraic equations with the Solver.
- Switch between conventional algebraic mode and the RPN (Reverse Polish Notation) familiar to many HP calculator users.

In this section you'll learn how to

- [Start the HP Calculator.](#)
- [Perform a math function on one number.](#)
- [Do simple arithmetic.](#)

## To start HP Calculator

- Click Start, Programs, OmniBook, and HP Financial Calculator.

## To perform a math function on one number

1. Type the number. The number appears in the Calc line.



2. Click the button for the desired math function.

—or—

Press the key on the OmniBook keyboard corresponding to the desired math function.

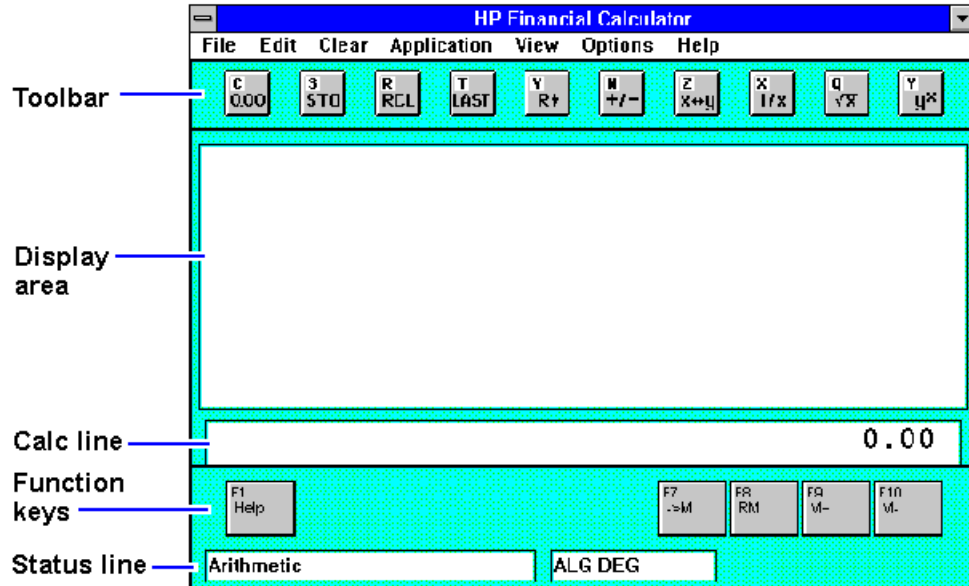

HP Calculator “takes over” part of your OmniBook’s keyboard and reassigns functions to it. You can see these functions and the applicable keys on the display of the calculator buttons—for example, pressing the Q key takes the square root of the number in the Calc line.

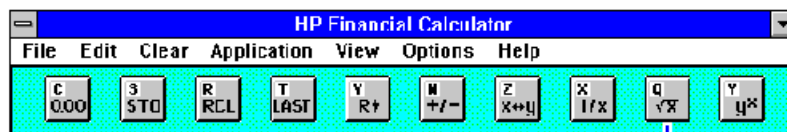

The Q key performs this function.

---

## Hints

Use BACKSPACE to correct a single keystroke on the Calc line.

Use DEL to erase the entire Calc line and reset it to zero.

---

## To do simple arithmetic

1. Type the calculation in the Calc line.
2. Press ENTER (or the = key).

Your OmniBook’s HP Calculator application starts in algebraic mode, shown by the letters ALG in the status line. When algebraic mode is active, you can type a number into the Calc line, then type an arithmetic operator like +, then type another number and press ENTER or the = key to see the answer.

If you are entering a multi-step problem, intermediate results are calculated when you type the next arithmetic operator. You can also type parentheses to group different parts of a calculation.

## 6. Making Connections

- [Connecting a Printer.](#)
- [Connecting an External Display.](#)
- [Connect an External Mouse and Keyboard.](#)
- [Making Serial Connections.](#)
- [Making Parallel Connections.](#)
- [Making Infrared Connections.](#)

Your OmniBook is a powerful computer in its own right—but you'll greatly expand its capabilities by connecting other devices.

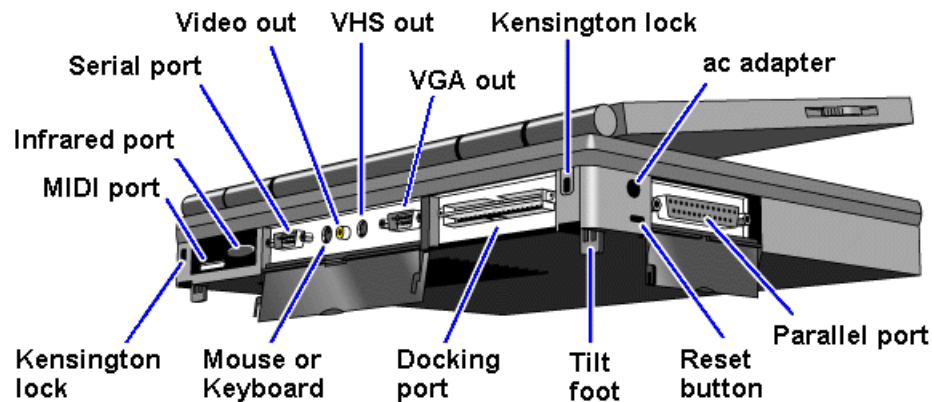

For information about connecting audio devices, see [“To connect a microphone, speakers, or headphones.”](#)

---

### Connecting a Printer

Before you can print from your OmniBook, you have to set up the OmniBook so it knows how to communicate with the printer.

You can set up the OmniBook to print on several types of printers. However, you can select only one printer as the default printer.

In this section you'll learn how to

- [Install a printer.](#)
- [Change printer settings.](#)

#### To install a printer

Setting up a printer includes specifying the type of printer, specifying the port where the printer will be connected, and possibly defining other printer options. You don't need to connect a printer in order to install it—you can install printers in advance.

1. Click Start, then HP User Tools.
2. From the Setup tab, click Printers. If your printer isn't listed, double-click Add Printer to start the Add Printer wizard. Follow the Add Printer wizard's instructions.
  - A parallel printer is normally at the LPT1 port.
  - An infrared printer is normally at the LPT3 port (a "virtual" port).
  - A serial printer is normally at the COM1 port.

For information about connecting the printer and the OmniBook:

- For a parallel printer, see ["Making Parallel Connections."](#)
- For an infrared printer, see ["Making Infrared Connections."](#)
- For a serial printer, see ["Making Serial Connections."](#)

### To change the printer's settings

1. Click Start, Settings, Printers.
2. Using the right mouse button, click the Printer you want to change. Click Properties from the shortcut menu.
3. From the Details tab select the options you want change.

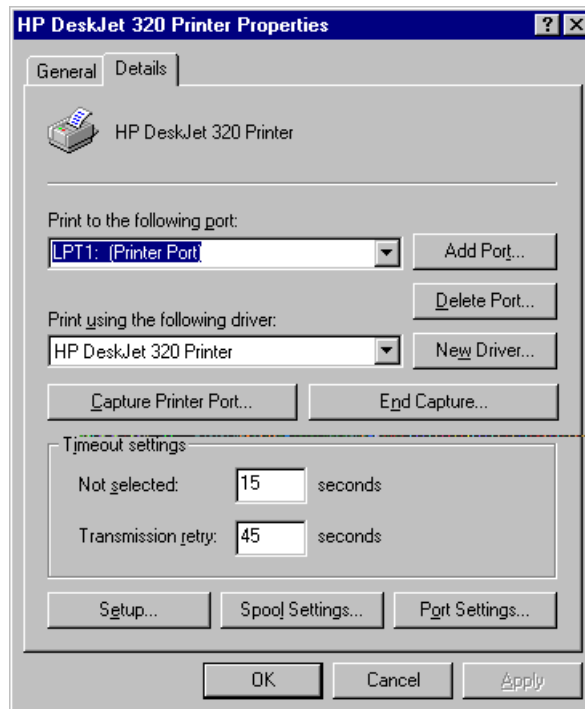

---

## Connecting an External Display

You can connect an external display device to your OmniBook. For example, you can connect a VGA projection panel, a VGA display, a television, or an SVHS VCR.

The OmniBook supports either PAL or NTSC video modes when connected to a television.

In this section you'll learn how to

- [Connect to a VGA, SVGA, or XGA monitor.](#)
- [Change the display type.](#)
- [Switch between the internal and an external display.](#)
- [Connect to a television or VCR.](#)
- [Change the television type.](#)
- [Connect to an SVHS device.](#)

## To connect an external monitor

1. Make sure the external monitor supports VGA, super VGA, or XGA format.
2. Plug the VGA cable from the external display into the SVGA-out connector at the back of the OmniBook.

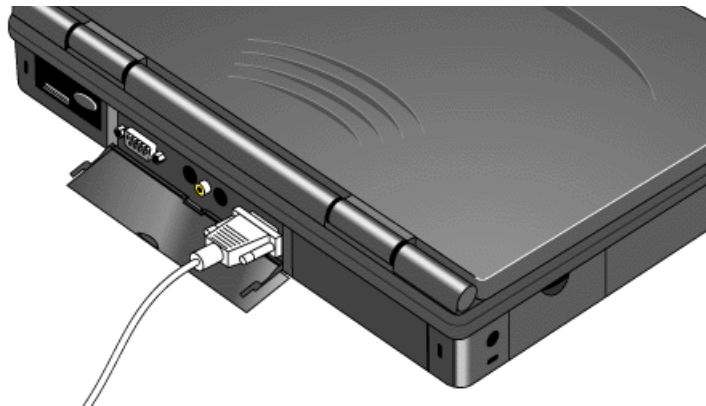

The OmniBook automatically recognizes and activates the external monitor. The built-in display normally turns off to conserve power and backlight life—but if you keep it on, you may notice a slight dimming while the external display is connected.

## To change the display type

The default display setting provides optimum performance for the OmniBook display. However, in certain situations, you may want to select different display options instead.

1. Click Start, HP User Tools, Setup, Display, Settings.
2. If you only want to change the resolution (for example, 640x480), use the Desktop area slider.
3. If you want to change monitor types, click Change Display Type.

4. Change the type of monitor to match the model you're using. If the external display has higher resolution than the OmniBook display, you'll have to turn off the OmniBook display to see the higher resolution.

### To switch between external and built-in displays

- Press FN+F5 to switch between the external and built-in display.

### To connect a television or VCR

You can use your television as an external monitor. You can also videotape procedures by connecting your OmniBook to your VCR. If you have an SVHS television or VCR see "[To connect an SVHS device.](#)"

1. Make sure the television or VCR has a standard Video In RCA connector. Plug a video cable into the connector.
2. Set the OmniBook's display resolution to 640x480 (other resolutions will not work). See "[Changing the Display Type](#)" for more information.
3. Plug the video cable from the television or VCR into the Video Out connector on the back of the OmniBook.

The OmniBook automatically senses and enables video output.



### To change the television type (NTSC or PAL)

The OmniBook supports the European standard (PAL) and US standard (NTSC) video formats.

1. **Important**  
Save all of your work—you will be rebooting your OmniBook.
2. Press FN+F2 to start the System Configuration utility.
3. From the Input/Output menu, click External Device.

4. In the Television Type box, select NTSC or PAL, then click OK.
5. From the Exit menu, click Save and Reboot. Click OK in the Save and Reboot dialog box.

### To connect an SVHS device

1. Make sure the device has an SVHS connector. Plug an SVHS video cable into the connector.
2. Set the OmniBook's display resolution to 640x480 (other resolutions will not work). See "[To change the display type](#)" for more information.
3. Plug the SVHS video cable from the device into the SVHS Out connector on the back of the OmniBook.

The OmniBook automatically senses and enables SVHS output.

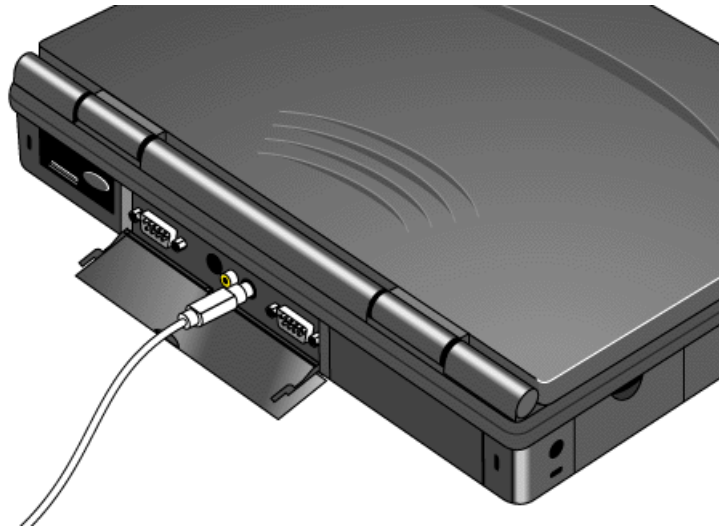

---

## Connect an External Mouse and Keyboard

Although the OmniBook comes with a full-sized keyboard, you can attach an external keyboard and an external mouse.

In this section you'll learn how to

- [Connect an external mouse or keyboard.](#)
- [Enable external FN keys.](#)
- [Connect an external mouse and keyboard at the same time.](#)

### To connect an external mouse or keyboard

If you attach an external mouse, you cannot use the built-in pointing device.

1. Plug the mouse or keyboard cable into the external mouse/keyboard port on the back of the OmniBook.

2. Turn the OmniBook off and on again with the blue On/Off button.

See also ["To connect an external mouse and keyboard."](#)

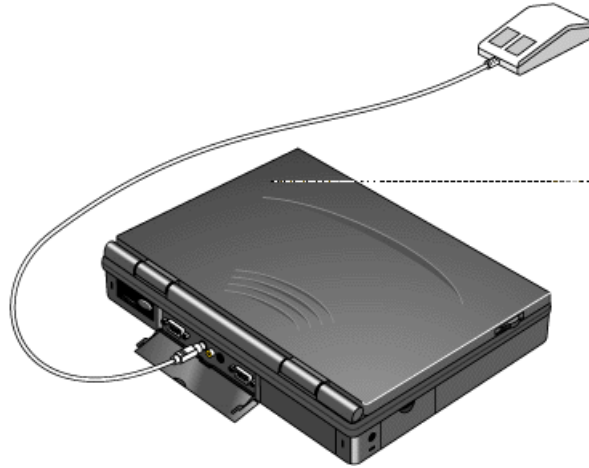

### To enable external FN keys

If you've connected an external keyboard, you need to enable the external FN keys.

1. Press Fn+F2.
2. From the Input/Output menu, select External Devices.
3. Check Enable External FN Key.

To access the FN key on your external keyboard, use CTRL+ALT. For example, to access Fn+F2, press CTRL+ALT+F2.

### To connect an external mouse and keyboard

1. Purchase a standard Y-adapter available at computer dealers and electronic supply stores.
2. Plug the Y-adapter into the external mouse/keyboard port.
3. Connect the external mouse and keyboard to the Y-adapter. You cannot use the built-in pointing device while an external mouse is attached.



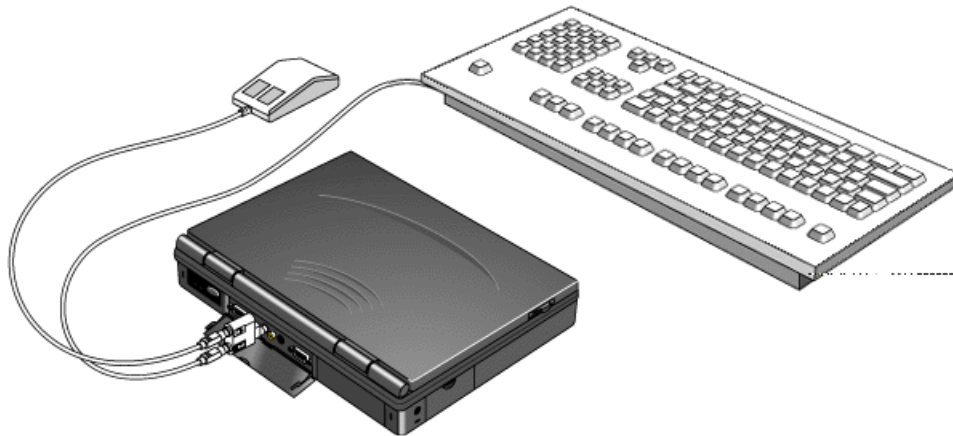

---

## Making Serial Connections

The OmniBook serial port is a standard 9-pin serial port. It supports hardware handshaking, a method of data-flow control that uses signals sent over reserved wires in the serial cable.

This section shows how to

- [Connect a serial device.](#)
- [View or change the serial port assignments.](#)
- [Specify serial port settings.](#)

### To connect a serial device

The OmniBook 9-pin serial port is a standard serial port, just like those found on many PCs. The most common types of serial connections involve printers, modems, and other computers. You can make such connections using standard serial cables and adapters available at computer dealers and electronic supply stores.

You can use Direct Cable Connection to link two PCs and share files, drives, and printers between them. You can make a serial connection with a serial or null-modem cable (using the COM1 port).

- To start the Direct Cable Connection wizard, click Start, Programs, Accessories, Direct Cable Connection on each computer. One computer must be the “host,” and the other computer must be the “guest.”

### To view or change serial port assignments

You can see and change the serial communications port names (COM1, COM2, COM3, and COM4) assigned to the serial port and infrared port.

1. Press FN+F2 to start the System Configuration utility.
2. Use the Input/Output menu COM Ports command to change the COM names for the serial port and the physical infrared port (normally COM1 and COM2). PCMCIA serial-type cards use the remaining COM names.
3. Exit the utility without rebooting—then click Start and Shut Down to restart the OmniBook. You must restart to make the new assignments active.

## To specify serial port settings

Many applications provide a way for you to adjust the settings for serial ports they use. Other applications don't let you change serial port settings. However, you can use Control Panel to set the basic serial port settings—the ones used by an application that doesn't change settings.

1. Open the System Properties window.
2. Click the Device Manager tab to see a list of serial (COM) ports.
3. To view the settings for a COM port, select the port and click Properties. (The serial port is normally COM1, and the physical infrared port is normally COM2.)

To find out the port name for a particular serial connection, see the previous topic.

The changes you make to the *advanced* settings for a serial port should match your hardware settings. The built-in advanced settings are listed below—you shouldn't use different settings in any applications.

- COM1: address 3F8 hex, interrupt 4.
- COM2: address 2F8 hex, interrupt 3.
- COM3: address 3E8 hex, interrupt 4.
- COM4: address 2E8 hex, interrupt 3.

---

## Making Parallel Connections

The OmniBook parallel port is a standard EPP 25-pin parallel port. It supports bi-directional data transfer.

This section shows how to

- [Connect a parallel device.](#)
- [View or change the serial port assignments.](#)

## To connect a parallel device

The OmniBook 25-pin parallel port is a standard parallel port. The most common types of parallel connections involve connections to printers and to other computers.

- For a printer connection, use a standard parallel printer cable available at computer dealers or electronic supply stores.
- For any other connection, such as a bi-directional connection, use a special parallel cable designed for that purpose. See the manual for the software you're using.

You can use Direct Cable Connection to link two PCs and share files, drives, and printers between them. You can make a parallel connection with a parallel cable (using the LPT1 port).

To start the Direct Cable Connection wizard, click Start, Programs, Accessories, Direct Cable Connection on each computer. One computer must be the “host,” and the other computer must be the “guest.”

## To view or change parallel port assignments

You can see and change the parallel port names (LPT1, LPT2, LPT3) assigned to the printer port.

1. Save any open files—you may need to reboot your OmniBook.
2. Press FN+F2 to enter the System Configuration utility.
3. From the Input/Output menu, click LPT Port.
4. Select the new port assignment and click OK.
5. From the Exit menu, click Save and Reboot.  
If you're prompted, enter your password, then click OK.
6. Click OK to reboot your OmniBook.

The parallel address are as follows:

- LPT1: address 378 hex.
- LPT2: address 278 hex.
- LPT3: address 3BC hex.

---

## Making Infrared Connections

The infrared port provides a type of serial connection that doesn't require cables—you just have to line up the device's infrared port with the right rear of your OmniBook.

In this section you'll learn how to

- [Make an infrared connection.](#)
- [Connect to an infrared \(IrDA-compatible\) printer.](#)

## To make an infrared connection

Keep the distance within about 3 feet (1 meter) for optimum performance. For example, you can establish a connection to an infrared printer by simply aiming the back of the OmniBook at the printer.

You can use Direct Cable Connection to link two PCs and share files, drives, and printers between them. You can make a wireless infrared connection using the COM4 port, a “virtual” port.

The infrared port provides a type of serial connection that doesn't require cables—you just have to line up the device's infrared port with the back-center of your

OmniBook. Keep the distance within about 3 feet (1 meter) for optimum performance.

For example, to establish a connection to another OmniBook

1. Align the two infrared devices to communicate.
2. Click Start, Programs, Accessories, Direct Cable Connection on each computer.

One computer must be the "host," and the other computer must be the "guest."



## To print on an infrared printer

To connect to an infrared (IrDA-compatible) printer, set the OmniBook printer port to be the infrared printer port, LPT3. See ["To change a printer's settings."](#) You can print to an infrared printer only while Windows and the Infrared Monitor are running.

The Infrared Monitor provides visual status for infrared communications and helps you resolve infrared communication problems.

### To start the Infrared Monitor

- Click Start, Infrared. Use the tabs in the infrared window to set options.

You can disable infrared printing by unchecking the Enable infrared communication box in the Options tab.

For more information about IrMonitor, see its online help.

## 7. Using the Docking System

- [Setting up the docking system.](#)
- [Docking the OmniBook.](#)
- [Undocking the OmniBook.](#)
- [Installing an ISA card.](#)
- [Installing a PCI card.](#)

With the HP Docking System, you can significantly increase the capabilities of your OmniBook. Your docking system helps you connect your OmniBook quickly and easily to your office equipment and software. If you use the docking system with a 101/102-key keyboard, a mouse, and an external display, your OmniBook is transformed into a “desktop workstation.” When you work at your desk, you can use a standard keyboard, mouse, and display—all tied into your OmniBook.

In addition, with a network connection, you can easily tap into the services available on your local network.

---

### Setting Up Your Docking System

With a docking system, your OmniBook becomes even more convenient whenever you work at your desk. By making one connection—plugging your OmniBook into the docking system—you can get convenient access to these types of connections:

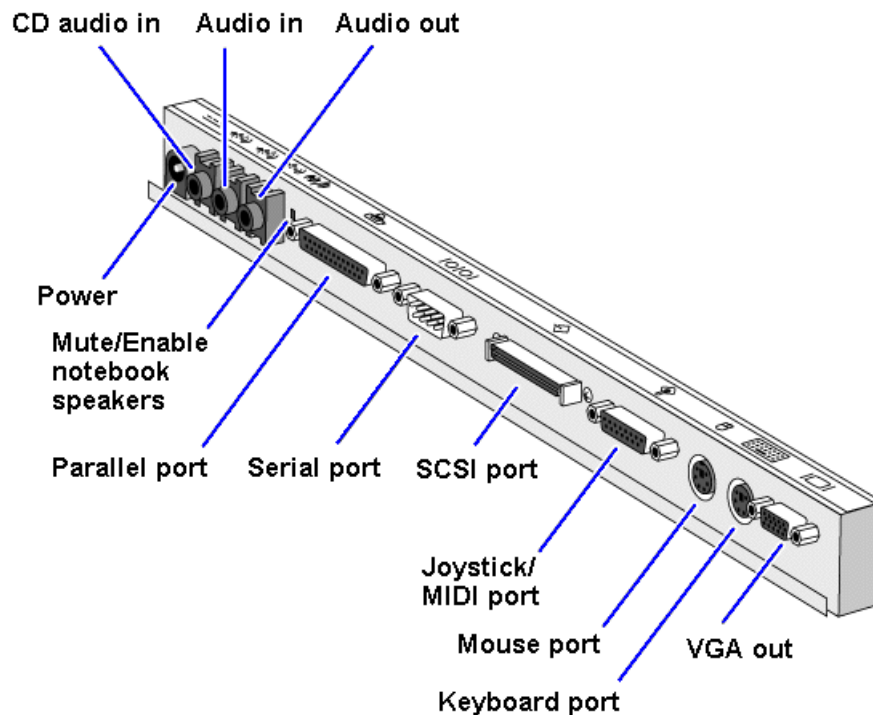

## To set up the docking system

### 1. Optional

To adjust the typing angle of keyboard, you can connect the tilt legs to the docking system. Gently press inward on the tilt feet and snap on at one of the three height settings shown below.

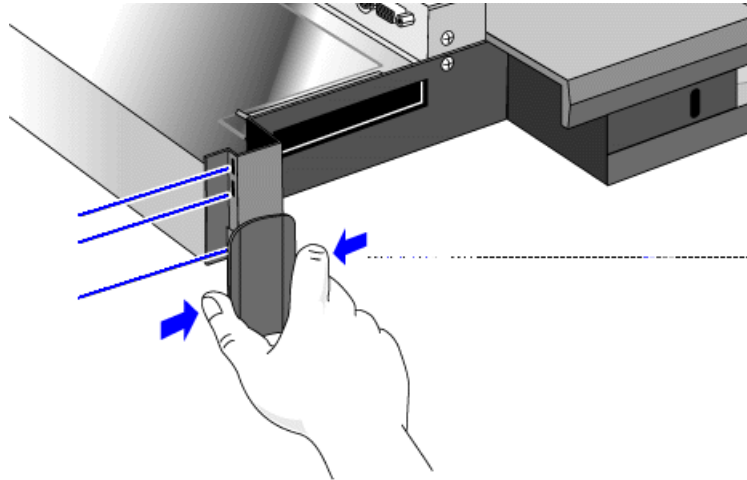

2. Unplug the OmniBook's ac adapter and cables, then close the cable door.
3. Open the OmniBook's docking port door and slide the door under the port.



4. Plug the power cord into the ac adapter, then into a grounded ac outlet. Plug the connector from the ac adapter into the port on the back of the docking system.

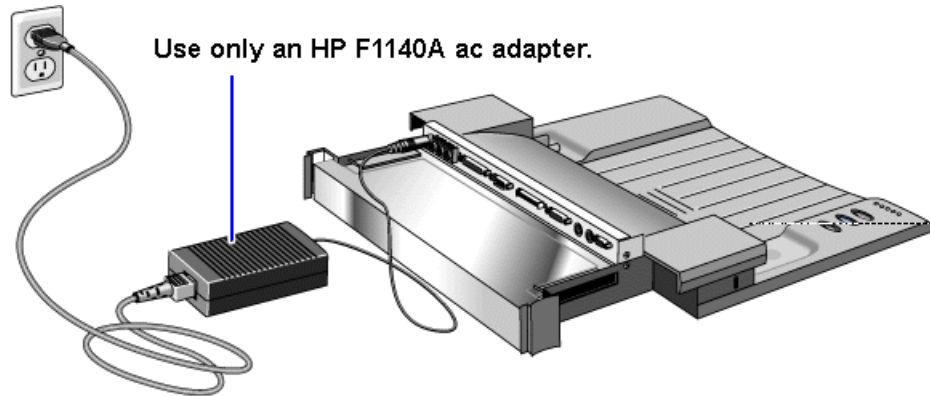

---

### Caution

Use only an HP F1140A ac adapter (the type shipped with the docking system)—do not use the ac adapter from the OmniBook or another product. Using an improper adapter could damage your equipment and will make your warranties invalid.

---

5. Place the cable cover on the docking system.

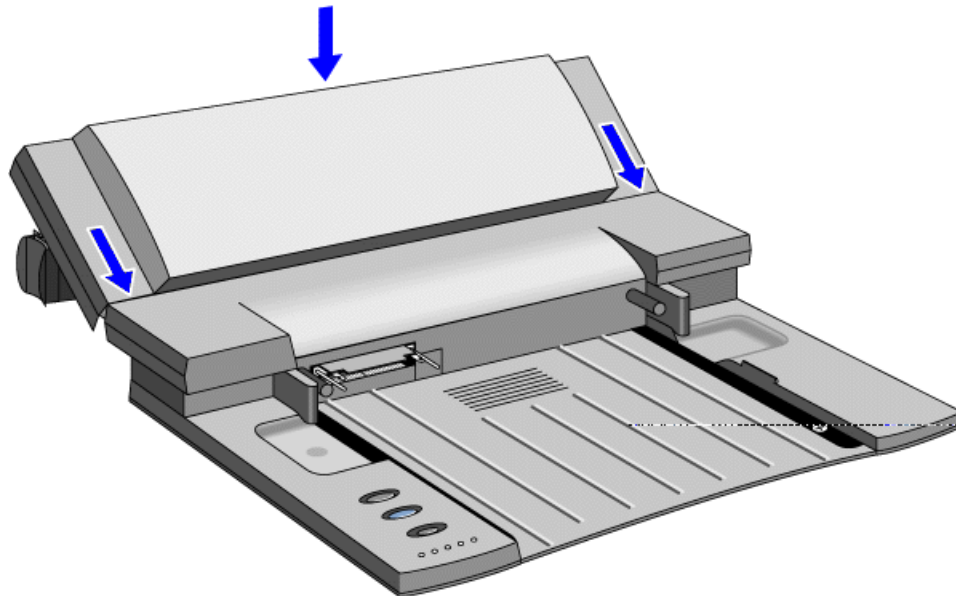

### To dock the OmniBook

1. Collapse the OmniBook tilt feet. The OmniBook will not align correctly with the docking port if the tilt feet are extended.

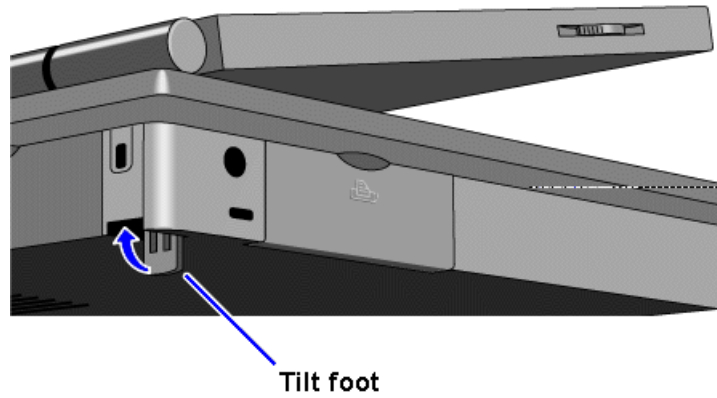

2. Place the OmniBook on the docking system and firmly push toward the docking pins until the docking system's motor pulls the computer into the dock.

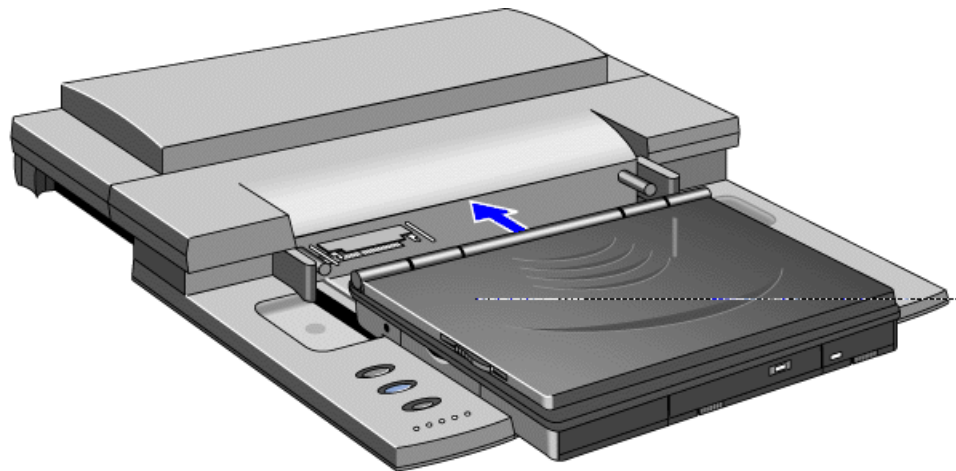

### To undock your OmniBook

- Turn the OmniBook on and press the Undock button.

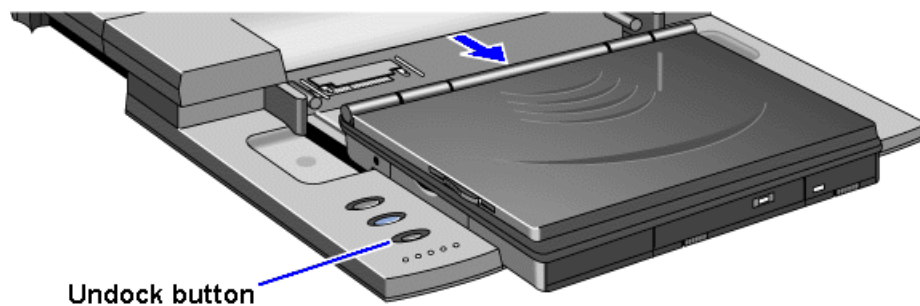

The OmniBook closes down any connections to the docking system and ejects the computer.



You can protect against unauthorized undocking using your OmniBook password. See [“To set up a user password.”](#)

If for some reason you can't undock the OmniBook using the Undock button, you can manually undock it. Insert a long thin object—such as an auto key—into the security opening and press firmly. Continue holding, and slide the OmniBook forward. Since manual undocking overrides any password, you need to keep a Kensington lock in the security slot to absolutely enforce password protection.

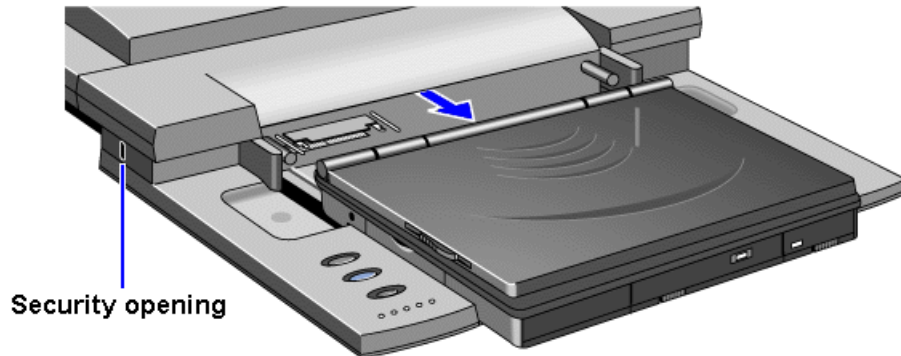

### **About the OmniBook buttons and status lights**

The docking system has 3 buttons used for the following:

Top button	Resets the OmniBook
Center button	Turns the OmniBook on and off.
Bottom button	Releases the OmniBook from the docking system.

The docking system has 5 status lights. The following table describes what each light indicates—starting from left to right.

Light on	indicates hard drive activity.
Light on	indicates floppy disk drive activity.
Blinking light	indicates password required.
Light on	indicates OmniBook docked successfully.
Red light only	indicates docking system has power.
Red and green light	indicates that both the docking system and the OmniBook have power.

### **To install an ISA card**

You can add up to two ISA cards, such as network (LAN) cards, to the docking system.

---

### **Caution**

**Before removing the card from its bag, equalize static electricity by touching the bag and the port replicator's metal back plate at the same time. Handle the card by its edges. Avoid touching electronic components.**

---

1. Undock the OmniBook and unplug the ac adapter from the docking system.
2. Remove the cable cover.
3. Slide the metal shield from the base.  
If the shield is difficult to slide, you can insert a pen or small screwdriver into the gap between the shield and base and gently work the shield loose. Be sure to loosen the shield evenly on both the right and left sides before attempting to remove it.

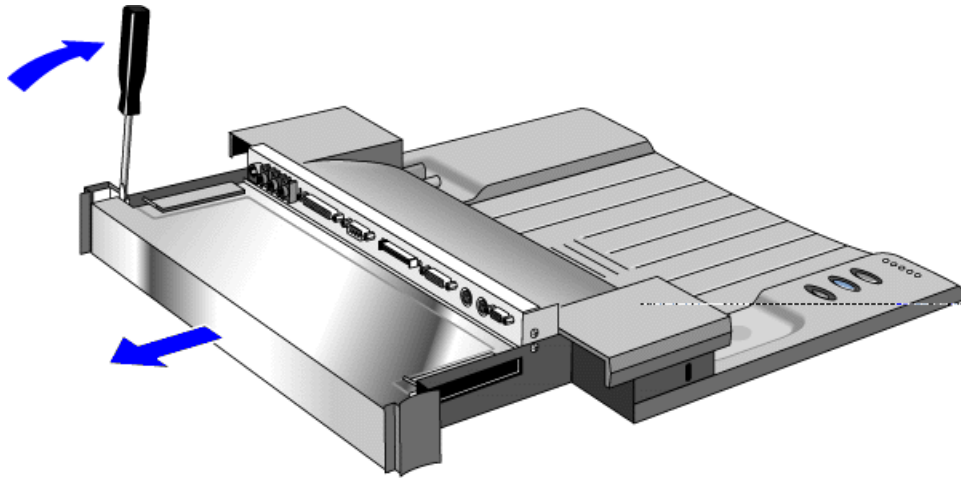

4. Unscrew and remove the slot cover next to the card slot you want to use.
5. Slide the ISA card firmly into the connector and replace the slot cover screw.

**Important** If you have already installed a PCI card, you can only install one ISA card—and it must be in the lower ISA slot.

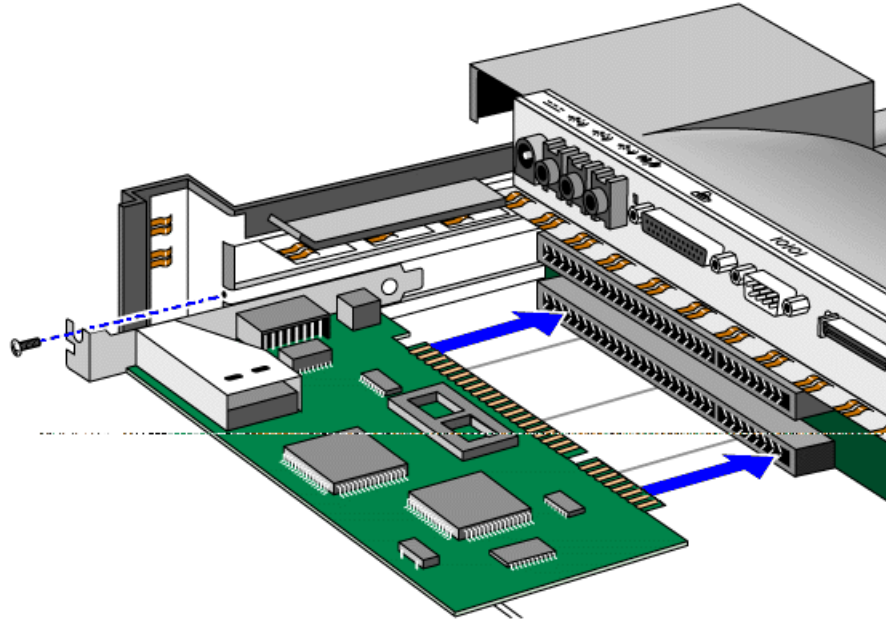

6. Replace the shield.
7. Replace the cable cover.
8. Plug in the ac adapter and dock the OmniBook.
9. If the card isn't detected, contact the card manufacturer.

### To install a PCI card

You can add one PCI card to the docking system. If you install a PCI card, you can only install one ISA card—and it must be in the lower ISA slot.

---

#### Caution

**Before removing the card from its bag, equalize static electricity by touching the bag and the port replicator's metal back plate at the same time. Handle the card by its edges. Avoid touching electronic components.**

---

1. Undock the OmniBook and unplug the ac adapter from the docking system.
2. Remove the cable cover.
3. Slide the metal shield from the base.  
If the shield is difficult to slide, you can insert a pen or small screwdriver into the gap between the shield and base and gently work the shield loose. Be sure to loosen the shield evenly on both the right and left sides before attempting to remove it.

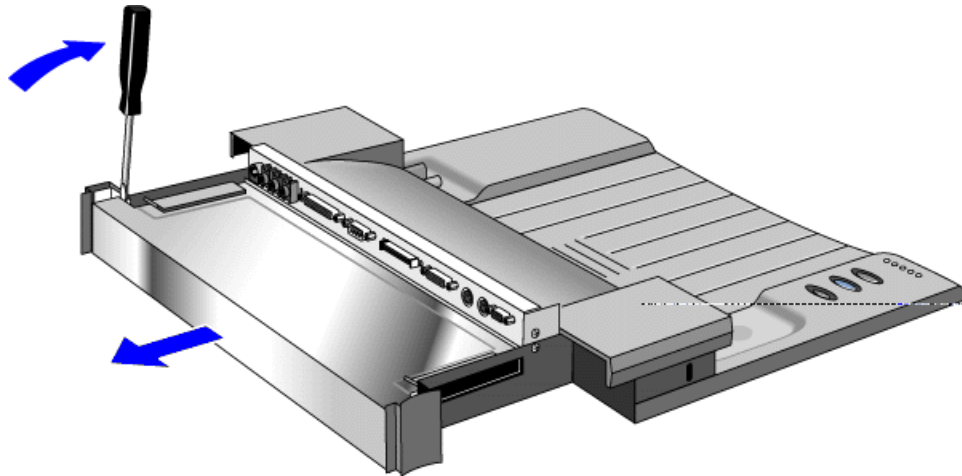

4. Unscrew and remove the slot cover next to the card slot you want to use.
5. Slide the ISA card firmly into the connector and replace the slot cover screw.
6. Replace the shield.
7. Replace the cable cover.
8. Plug in the ac adapter and dock the OmniBook.
9. Install the software for the card.
10. If the card isn't detected, in Control Panel double-click Add New Hardware.

## 8. Troubleshooting

- [Solving Problems.](#)

If you run into problems using your OmniBook, you can use the suggestions in this chapter for getting back on track. Also check the contents and index for pointers to related information.

If you have questions that this manual doesn't answer, you can

- Look at the online Help for Windows and other applications.
- Check with your computer system administrator, if you have one.
- Check your local library or bookstore for other books about Windows, MS-DOS, and other applications.
- Contact your dealer, or contact Hewlett-Packard—see the OmniBook *Support and Service* booklet.
- Windows provides “troubleshooters” for several types of common problems. Click Start and Help. On the Contents tab, open the Troubleshooting book, then start the desired troubleshooter.

---

### Solving Problems

This section separates problems into the following categories:

- [Printing problems.](#)
- [Memory problems.](#)
- [Pointing device and mouse problems.](#)
- [File, drive, and PC card problems.](#)
- [Serial and infrared communications problems.](#)
- [Sound problems.](#)
- [Display problems.](#)
- [Power and startup problems.](#)
- [Lockup problems.](#)

### Printing Problems

#### **If the serial printer doesn't print**

- Check that you're using a proper cable or cable adapter.
- Select the Fast Printing Direct To Port option—in OmniBook Tools click Connections and Printers, then select the serial printer and click Connect.
- In Windows Help, use the Print Troubleshooter.

#### **If the infrared printer doesn't print**

- If you're printing to an infrared printer, make sure its port is set to LPT3 (not COM2 or LPT1). Check the printer's property sheet.
- Start Infrared Monitor before you print. Click Start, Infrared.
- For infrared printing from an MS-DOS program, run the program in an MS-DOS window instead of in MS-DOS mode.
- In Windows Help, use the Print Troubleshooter.
- Make sure the infrared light path is not blocked. See ["To make an infrared connection."](#)
- Make sure Windows is running—infrared printing is supported only while Windows is running.
- Make sure the infrared printer is IrDA compatible.
- Make sure you have not disabled IrDA support on your OmniBook.

#### **If the parallel printer doesn't print**

- Check that you're using a standard parallel printer cable.
- If you can print from another application, check the current application. The application itself may be at fault.

#### **If the printer stops when you turn off the OmniBook**

- If the ac adapter is connected, don't turn off the OmniBook until the job is finished printing. When you turn off the OmniBook while the ac adapter is connected, it sends a reset signal to the printer. (If you're not using the ac adapter, no reset signal is sent.)

#### **If the left edge of printed output is missing**

- If the printer you're using is a 600-dpi (dots per inch) printer, try selecting a compatible printer driver for a 300-dpi printer. For example, for a 600-dpi HP LaserJet printer, try using the HP LaserJet IIIsi driver (300-dpi). Certain applications may not work properly with 600-dpi printers.

## **Memory Problems**

#### **If a message says you're out of memory**

To find out how much memory is in your OmniBook, see ["To find the system software and memory size."](#)

- It's recommended that your OmniBook have at least 8 MB of memory for running Windows 95. Performance should increase noticeably with even more memory.
- In Windows Help, use the memory troubleshooter.
- If you're having memory problems running MS-DOS programs, in Windows Help use the MS-DOS troubleshooter.

## **Pointing Device and Mouse Problems**

#### **If the cursor is difficult to control**

You can adjust the cursor movement in the Mouse Properties box.

1. Click Start, Settings, Control Panel.
2. Double-click the Mouse icon to open the Mouse Properties box.
3. Click Motion to adjust the cursor speed.

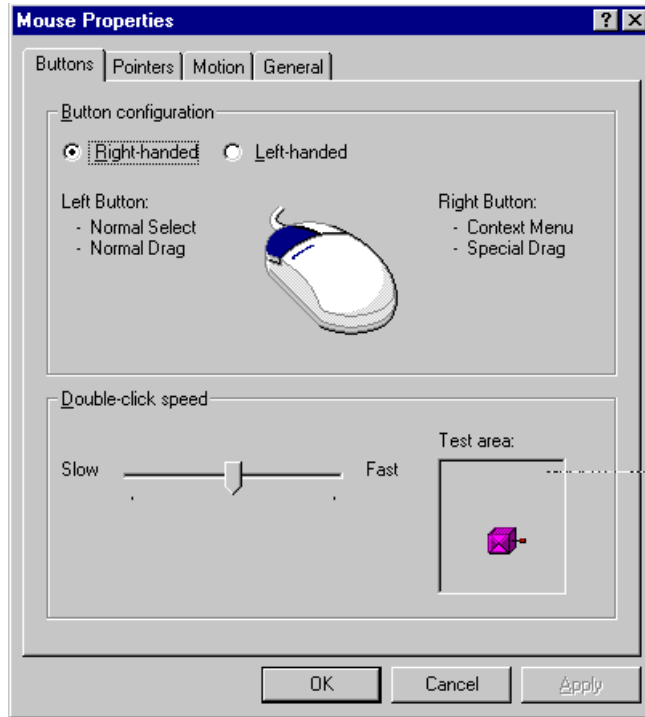

#### **If the pointing device doesn't work**

- Make sure you don't have an external mouse connected to the OmniBook.
- If you just disconnected an external mouse, try exiting and restarting Windows to make the OmniBook pointing device active again.
- Try cleaning the pointing device cap. See ["To clean the pointing device."](#)

#### **If a mouse connected to the serial port doesn't work properly**

- If you connect a serial mouse, you must set it up manually.
  1. Click Start, Settings, Control Panel.
  2. Double-click Add New Hardware.
  3. Follow the instructions on the screen.
  4. When you have finished installing the serial mouse, you'll be prompted to restart the OmniBook. Keep the serial mouse connected when you restart.

### **File, Drive, and PC Card Problems**

For information about maintaining your disk drives, see ["Protecting Your Data."](#)

### **If a PC card doesn't work properly in a card slot**

- Try removing and reinserting the card.
- Try inserting the card in the other card slot to check the connector.
- Try removing a PC card from the other card slot, if another card is present.
- For a data storage card, check that you're using the correct drive letter.
- If a data storage card doesn't work properly, check if it has a write-protect switch and that it is set properly.
- If a modem card doesn't work properly, in Windows Help use the modem troubleshooter.

### **If a floppy drive doesn't work**

- Check to see that the floppy disk drive configuration is correct. Note that the floppy drive will not work on the dock parallel port—only on the OmniBook parallel port.
  1. Press FN+F2 to start the Software Configuration utility.
  2. From the Disks menu, click Floppy Disk Drive.
  3. Select 1.44 Mb and click OK.
  4. From the Exit menu, click Save and Exit.
  5. Click OK.

## **Serial and Infrared Communications Problems**

### **For serial and infrared problems**

- If a modem doesn't work properly, in Windows Help use the modem troubleshooter.

### **If an application can't access a serial port**

- Check that the COM name you're using is actually assigned to the port you're using—in OmniBook Tools click Connections and COM Ports.
- If an application doesn't support the COM port number you're using, change the port names—in OmniBook Tools click Connections and COM Ports.
- Check whether another application is preventing access to the port—even if it's not actively using it.
- Check in the communications application that you haven't changed the address and interrupt for the OmniBook port—for settings, see ["To specify serial port settings."](#)

### **If the OmniBook stops responding after accessing a serial port**

- If the OmniBook stops working, try turning it off and on.
- Press CTRL+ALT+DEL to reboot. If nothing happens, see ["To reset the OmniBook."](#)

### **If errors occur at serial speeds of 9600 baud or higher**



- Select a lower baud rate in the application.
- Use OmniBook Tools to temporarily disable Power Management. (In OmniBook Tools, click Power, click Custom, and clear the Power Management option.) If this fixes the problem, check to see if your communications software may have an update to avoid power-management problems. *Remember to enable Power Management when you're done.*

#### **If an I/O card stops communicating properly**

- It may have been reset if the OmniBook turned off. Exit and restart the application—and plug in the ac adapter, if possible.

#### **If you have problems with infrared communications**

- Check that only one application is using the infrared port.
- Check that both devices are using the same protocol, such as IrDA.

## **Sound Problems**

#### **If sounds aren't audible**

- Check the playback or recording sound levels, channels, and muting—double-click the speaker symbol in the taskbar.



- Press FN+F9 several times to make sure the volume isn't set too low.
- If you've connected an external keyboard, make sure you've enabled the external FN keys.
  1. Press Fn+F2.
  2. From the Input/Output menu, select External Devices.
  3. Check Enable External FN Key.
  4. Press CTRL+ALT+F9 several times to make sure the volume isn't set too low.

## **Display Problems**

- Check whether the display resolution is set to its default setting—see [“To change the display type”](#)
- Try changing the display setting to the VGA option. See [“To change the display type.”](#)

#### **If the display scrolls when the pointer reaches the edge**

- A high-resolution display setting is active—you can use an external display and turn off the OmniBook display, or you can choose the default OmniBook display setting. See [“To change the display type.”](#)

## **Power and Startup Problems**

### **If the OmniBook doesn't reboot successfully**

- If drive C (the hard disk) isn't working properly, insert the *Support Utility* floppy disk in the floppy drive, then press CTRL+ALT+DEL to reboot from drive A—then choose the Minimum Startup option. At the MS-DOS prompt, type **scandisk c:** to fix certain problems with drive C. You can use other commands on drive A to try to repair drive C. Then remove the floppy disk and try rebooting again. If it still doesn't start, you could try reinstalling all of the original files on drive C—see [“Restoring Files.”](#)

### **If the OmniBook doesn't reboot successfully from drive A**

- If the OmniBook doesn't reboot from drive A, press FN+F2 to start the System Configuration utility. Check that the floppy drive is the first boot device.

### **If the battery runs down too fast**

- Try conserving power using any of the suggestions listed under [“To save battery power”](#)
- If you have custom Power settings, check the Power Management option. See [“To change how power is managed.”](#) If Custom is selected, make sure the Power Management option is enabled.
- If the operating time has gotten shorter and the battery pack is more than a year or two old, you may need a new battery pack.

### **If the OmniBook turns off immediately after it turns on**

- Battery power is probably extremely low. Plug in the ac adapter, or turn off the OmniBook and insert a fresh battery—see [“To replace the battery.”](#)

### **If the OmniBook doesn't turn off automatically**

- If the ac adapter is connected, the OmniBook doesn't turn off by itself.
- If you have a connection to another computer, the OmniBook doesn't turn off if the connection is actively in use.
- If you have custom Power settings, check them. If Custom is selected, check the following settings:

Make sure the Power Management option is enabled.

Check the Computer time-out setting to see if it's set too long.

### **If the OmniBook doesn't turn on**

- Connect the ac adapter.
- Press On/Off to try turning on the unit.
- Try adjusting the display. See [“To adjust the display.”](#)
- Insert a ball-point pen tip or other slender object into the [reset](#) button on the left side of the case. Push in momentarily—the system should reset and reboot.

If you get no response, remove the battery and ac adapter and press the [reset](#) button again—then install the battery or plug in the ac adapter and try resetting again.

### **If the OmniBook doesn't turn on with a fresh battery**

- If the new battery pack is low, plug in the ac adapter.

### **If the OmniBook doesn't turn off immediately**

- If the OmniBook is performing an operation, it normally waits for the operation to finish.
- If you're using MS-DOS Prompt in the full screen (not inside a window), it normally takes about 10 to 15 seconds to turn off.

### **If the OmniBook reboots every time you turn it on**

- Advanced power management (APM) is probably disabled—in OmniBook Tools click Power, then select one of the options. If you select Custom, make sure the Power Management option is enabled.

#### **If the battery pack doesn't charge or stops charging**

- Check that the battery is fully installed and locked in place.
- Turn off the OmniBook, then check that the battery contacts are clean and that the ac adapter cables are fully plugged in.
- Move the OmniBook away from any nearby heat source. Unplug the ac adapter and allow the battery to cool down. An elevated battery temperature prevents charging or turns off the battery.

#### **If the OmniBook won't undock**

- Try turning it on and then undocking.

#### **If your system password doesn't work**

- Check whether Num Lock is off. Try changing it.
- If you've forgotten your password, have your OmniBook at hand and call Hewlett-Packard at the phone number in the *Service and Support* booklet.

#### **If the screen is difficult to read**

- Try adjusting the display. See ["To adjust the display."](#)
- If the OmniBook is cold, allow it to warm up.

## **Lockup Problems**

#### **If an application stops responding**

- Press CTRL+ALT+DEL to reboot. If nothing happens, see ["To reset the OmniBook."](#)

#### **If a screen saver causes lockup**

- If you've previously set up an OmniBook password, you should delete the OmniBook password (use the Password icon in OmniBook Tools). Screen savers conflict with password protection, and together they can lock up the OmniBook.

# Index

## —A—

- ac adapter
  - connecting, 38
  - recharges battery, 38
  - socket for, 7
- adapter
  - external mouse and keyboard, 64
- adding
  - appointments, 52
  - events, 53
  - external keyboard, 63
  - external keyboard and mouse, 64
  - external mouse, 63
  - memory to OmniBook, 28
  - phone entries, 55
- addresses
  - serial ports, 66
- adjusting
  - display, 9
  - typing angle, 15
  - volume, 12
- admin password (OmniBook Tools), 47
- Advanced Power Management, 18
- advanced settings
  - serial ports, 66
- alarms, 53
- ALT GR key, 16
- APM (Advanced Power Management), 18
- Appointment Book
  - adding appointments, 52
  - adding events, 53
  - exiting, 54
  - introduction to, 51
  - starting application, 51
  - viewing appointments, 51
- arithmetic
  - with calculator, 57
- audio system
  - adjusting volume, 12
  - connecting microphone, 13
  - connecting speakers or headphones, 13
  - connecting stereo input, 13
  - Sound Blaster compatible, 12
  - turning off sound, 13
- automatic shutdown, 19

## —B—

- backlight, 61
- backup disks
  - creating, 34
- battery
  - charge level, 42

- charging light, 39
- charging order, 42
- installing a second battery, 41
- location, 7
- power management, 43
- RAM card, 27
- recharging, 38
- replacing, 39
- safeguards, 37
- saving power, 42
- status, 42
- warning, 39
- battery (high-capacity)
  - installing, 41
  - removing, 24
- boot disks, 21
- brightness adjustment, 9
- buttons
  - docking system, 73

## —C—

- cables
  - floppy drive, 24
  - parallel printer, 66
  - serial, 65
  - VGA adapter, 61
- calculator
  - introduction to, 56
  - performing a function, 56
  - simple arithmetic, 57
  - starting application, 56
- cap
  - cleaning, 11
- cards
  - data storage, 26
  - I/O, 26, 81
  - I/O port names, 65
  - inserting, 26
  - ISA, 73
  - PCI, 75
  - RAM, 27
  - removing, 27
  - troubleshooting, 79
- CD-ROM drive
  - inserting a CD, 25
  - installing, 25
  - removing, 24
- changing
  - printer settings, 60
- charge level indicator, 42
- charging
  - battery order, 42
  - light, 39
  - status, 19

- click buttons, 10
- connecting
  - external keyboard and mouse, 64
  - infrared device, 67
  - microphone, 13
  - parallel device, 66
  - printer, 59
  - serial device, 65
  - speakers or headphones, 13
  - SVHS device, 63
  - television or VCR, 62
  - two computers, 65
  - VGA display, 61
- Connections (OmniBook Tools), 59, 65, 67
- contrast adjustment, 9
- cord
  - power, 38
- creating
  - backup disks, 34
- cursor
  - controlled by pointing device, 10
  - customizing, 11

## —D—

- data cards
  - inserting, 26
  - removing, 27
- data storage status, 18
- defragmenting disks, 49
- deleting
  - appointments, 54
  - OmniBook files, 49
  - password, 47
- Direct Cable Connection, 65
- disable infrared printing, 68
- disks
  - cleaning up, 49
  - defragmenting, 49
  - repairing, 49
- display
  - adjusting brightness and contrast, 9
  - external, 61
  - problems, 81
  - turning off, 19
  - VGA, 61
- Display (OmniBook Tools), 61
- displaying
  - appointments, 51
- docking port, 7
- docking system
  - buttons, 73
  - docking OmniBook, 71
  - setup, 70
  - status lights, 73
  - undocking OmniBook, 72
- drive A
  - booting from, 21
  - location, 22

- drive C
  - defragmenting, 49
  - installing, 31
  - location, 22
  - removing, 30
  - removing files, 49
  - repairing, 49
- drives
  - CD-ROM, 8
  - connecting floppy, 23
  - drive C, location, 22
  - drive D, location, 22
  - drive E, location, 22
  - drive F, location, 22
  - floppy, 8
  - installing drive C, 31
  - not affected by low battery, 38
  - removing CD-ROM drive, 24
  - removing drive C, 30
  - removing floppy drive, 24
  - troubleshooting, 79

## —E—

- events (Appointment Book), 53
- exiting
  - Appointment Book, 54
  - Phone Book, 56
- expansion slot, 28
- external display
  - changing type, 61
  - connecting, 61
  - switching to and from, 62
- external keyboard
  - adding, 63
- external keys
  - enabling, 64
- external mouse
  - adding, 63
  - and keyboard, 64

## —F—

- files
  - deleting OmniBook, 49
  - removing, 49
  - troubleshooting, 79
- financial calculator
  - functions, 56
  - introduction to, 56
  - performing a function, 56
  - simple arithmetic, 57
  - starting application, 56
- finding
  - appointments, 51
  - names in Phone Book, 56
- floppy drive, 8
  - booting from, 21
  - connecting externally, 23

- drive A, 22
- removing, 24
- saving power, 42
- FN keys
  - combination, 16
  - enabling external, 64
- functions (Calculator), 56

## —G—

- getting help
  - about Windows, 16
  - finding more information, 5
  - online manual, 5

## —H—

- hard disk
  - conserving power, 42
  - installing, 31
  - location, 7
  - removing, 30
- hardware handshaking, 65
- headphones, 13
- help
  - about Windows, 16
  - finding more information, 5
  - online manual, 5
- high-capacity battery
  - drive for, 8
  - installing, 41
  - removing, 24
- HP Financial Calculator
  - introduction to, 56
  - performing a function, 56
  - simple arithmetic, 57
  - starting application, 56

## —I—

- I/O cards
  - description, 26
  - initializing, 81
  - inserting, 26
  - port names, 65
  - remove after use, 42
  - removing, 27
  - resetting, 81
- icons
  - status panel, 18
- infrared port
  - connections, 67
  - for printer, 59
  - location, 7
  - names, 65
  - problems, 80
  - range, 67
- initializing
  - I/O cards, 81

- input line, 13
- inserting
  - CD, 25
  - PC cards, 26
- installing
  - CD-ROM drive, 25
  - drive C, 31
  - ISA card, 73
  - PCI card, 75
  - printers, 59
  - second battery, 41
- Instant On, 20
- interrupts
  - serial ports, 66
- ISA card
  - installing, 73

## —K—

- Kensington lock
  - attaching, 44
- keyboard
  - adapter for external, 64
  - adding external, 63
  - connecting with external mouse, 64
  - FN key, 16
  - numeric keypad, 16
  - shifted keys, 16
  - status, 18

## —L—

- learning (Windows), 16
- light (orange charging), 39
- lights
  - docking system, 73
- linking two computers, 65
- lookup
  - problems, 84
- low battery
  - recharging, 38
  - replacing, 39
  - warning, 39

## —M—

- math, 56
- memory
  - adding, 28
  - finding size, 28
  - in OmniBook, 78
  - problems, 78
- microphone
  - connecting external, 13
  - location of built-in, 13
- modems
  - external, 65
- mouse
  - adapter for external, 64

adding external, 63  
mute, 13

## —N—

names  
  finding in Phone Book, 56  
NTSC output  
  location, 7  
Num Lock  
  operation, 16  
numeric keypad, 16

## —O—

OmniBook  
  adding memory, 28  
  docking, 71  
  identifying, 45  
  recovering applications, 34  
  recovering device drivers, 35  
  recovering online manual, 35  
  removing files, 49  
  resetting, 22  
  restoring files, 31  
  setting up docking system, 70  
  turning display off, 19  
  turning on and off, 19  
  undocking, 72  
  upgrading, 28  
OmniBook Tools  
  admin password, 47  
  Connections, 59, 65, 67  
  Display, 61  
  Personalize, 45  
  Power, 43  
  user password, 45  
On/Off button, 19  
online User's Guide, 5  
orange light, 39

## —P—

PAL output  
  location, 7  
parallel cables  
  connecting, 66  
  printer, 66  
  types, 66  
parallel devices, 66  
parallel ports  
  connections, 66  
  for printer, 59  
  location, 7  
  name assignments, 67  
  renaming, 67  
passwords  
  admin, 47  
  deleting, 47

  options, 46  
  user, 45  
PC cards  
  data storage, 26  
  I/O, 26  
  inserting, 26  
  removing, 27  
  slots for, 7  
  troubleshooting, 79  
PCI card  
  installing, 75  
Personalize (OmniBook Tools), 45  
Phone Book  
  adding a name, 55  
  exiting, 56  
  introduction to, 54  
  starting application, 54  
playing sound, 15  
pointing device, 10  
  cleaning cap, 11  
  customizing, 11  
  troubleshooting, 78  
  using, 10  
ports  
  conflicts, 80  
  locations, 7  
power  
  cord, 38  
  managing, 43  
  OmniBook Tools, 43  
  problems, 81  
power management, 18  
  adjusting, 43  
  checking power status, 19  
  introduction, 37  
printer  
  changing settings, 60  
  installing, 59  
  problems, 77  
  setting up, 59  
protecting OmniBook  
  with admin password, 47  
  with Kensington lock, 44  
  with user password, 45

## —R—

RAM cards  
  battery, 27  
rebooting  
  from drive C, 21  
  from floppy drive, 21  
rechargeable battery, 37  
recording sound, 14  
recovering  
  device drivers, 35  
  OmniBook applications, 34  
  online manual, 35  
  Windows 95, 31



- Windows for Workgroups, 32, 33
- removing
  - appointments and events, 54
  - battery, 39
  - CD-ROM drive, 24
  - drive C, 30
  - drive C files, 49
  - files, 49
  - floppy drive, 24
  - I/O cards, 27
  - memory-expansion board, 28
  - PC cards, 27
  - pointing device cap, 11
  - second (high-capacity) battery, 24
  - turn-on password, 47
- replacing
  - battery, 39
  - pointing device cap, 11
- resetting
  - I/O cards, 81
  - OmniBook, 22
- resolution
  - external display, 61
- restoring files, 31

## —S—

- Save-To-Disk, 20
- saving battery power, 42
- searching (Phone Book), 56
- securing the OmniBook, 44
- security
  - admin password, 47
  - attaching cable, 44
  - user password, 45
- serial
  - adapters, 65
  - devices, 65
  - port connections, 65
  - port location, 7
  - problems, 80
- serial ports
  - addresses, 66
  - advanced settings, 66
  - basic settings, 66
  - conflicts, 80
  - conserving power, 42
  - hardware handshaking, 65
  - interrupts, 66
  - name assignments, 65
  - renaming, 65
- setting
  - admin password, 47
  - parallel port names, 67
  - printer, 60
  - serial port names, 65
  - serial port settings, 66
  - user password, 45
- setting up

- docking system, 70
- printer, 59
- software version, 28
- sound
  - external jacks, 13
  - playing, 15
  - problems, 81
  - recording, 14
  - turning off, 13
- speaker, 13
- startup
  - problems, 81
- status lights
  - docking system, 73
- status panel
  - description of icons, 18
- stereo input, 13
- super VGA, 61
- SVHS device
  - connecting, 63
- system disks, 21

## —T—

- television
  - connecting, 62
- tilt feet, 15
- tour Windows, 16
- troubleshooting
  - display problems, 81
  - files and drives, 79
  - infrared problems, 80
  - lockup problems, 84
  - memory problems, 78
  - PC cards, 79
  - pointing device, 78
  - power problems, 81
  - printing problems, 77
  - serial problems, 80
  - sound problems, 81
  - startup problems, 81
- turning on and off
  - manually, 19
- TV
  - connecting, 62
- typing angle
  - adjusting, 15
- typing special characters, 16

## —U—

- upgrading the OmniBook, 28
- user passwords
  - deleting, 47
  - override with docking system, 73
  - setting up, 45

—V—

- VCR
  - connecting, 62
- VGA display, 61
- VGA output
  - connecting, 61
  - location, 7
  - resolutions, 61
- viewing
  - appointments, 51
- volume
  - adjusting, 12
  - muting, 13

—W—

- warning
  - low battery, 39
- Window for Workgroups
  - creating backup disks, 34
- Windows
  - learning about, 16
- Windows 95
  - recovering, 31
- Windows for Workgroups
  - recovering, 32, 33

—Y—

- Y adapter, 64