

PROPRIETARY NOTICE AND LIABILITY DISCLAIMER

The information disclosed in this document, including all designs and related materials, is the valuable property of NEC Corporation (NEC) and/or its licensors. NEC and/or its licensors, as appropriate, reserve all patent, copyright and other proprietary rights to this document, including all design, manufacturing, reproduction, use, and sales rights thereto, except to the extent said rights are expressly granted to others.

The NEC product(s) discussed in this document are warranted in accordance with the terms of the Warranty Statement accompanying each product. However, actual performance of each such product is dependent upon factors such as system configuration, customer data, and operator control. Since implementation by customers of each product may vary, the suitability of specific product configurations and applications must be determined by the customer and is not warranted by NEC.

To allow for design and specification improvements, the information in this document is subject to change at any time, without notice. Reproduction of this document or portions thereof without prior written approval of NEC is prohibited.

FastFacts, and NEC SVGA, are U.S. trademarks of NEC Technologies, Inc.

All other product, brand, or trade names used in this publication are the trademarks or registered trademarks of their respective trademark owners.

First Printing — August 1995

Copyright 1995
NEC Technologies, Inc.
1414 Massachusetts Avenue
Boxborough, MA 01719
All Rights Reserved

Copyright 1995
NEC Corporation
7-1 Shiba 5-Chome, Minato-Ku
Tokyo 108-01, Japan
All Rights Reserved

Preface

This service and reference manual contains the technical information necessary to set up, and maintain the NEC Versa™ 4000 Series notebook systems. It also provides hardware and interface information for users who need an overview of the computer system design. The manual is written for NEC-trained customer engineers, system analysts, service center personnel, and dealers.

Please refer to the training module provided on CD-ROM for system disassembly/assembly procedures.

The manual is organized as follows:

Section 1 — Technical Information, provides an overview of the hardware and interface components. System specifications are listed including computer dimensions, weight, environment, safety compliance, power consumption, and system memory specifications.

Section 2 — Setup and Operation, takes the user from unpacking to setup and operation. The section includes a description of operating controls, setting parameters and accessing the NEC bulletin board system (BBS).

Section 3 — Illustrated Parts Breakdown (IPB), provides an exploded-view diagram of the NEC Versa 4000 series system and part numbers.

Appendix A — Connector Locations and Pin Assignments, provides a list of the main board internal connector pin assignments and a list of external pin assignments.

An **Index** is included for convenience.

Contents

Preface.....	vii
Abbreviations.....	ix
Section 1 Technical Information	
Hardware Overview.....	1-2
Liquid Crystal Display (LCD).....	1-2
CPU Board.....	1-3
I/O Board.....	1-3
Sound Board.....	1-3
Infrared (IR) Front Assembly, Rear Assembly.....	1-4
Battery Pack.....	1-4
CMOS Battery.....	1-4
Bridge Battery.....	1-4
PCMCIA Slots.....	1-4
Diskette Drive and the NEC VersaBay II.....	1-5
Keyboard.....	1-5
NEC VersaGlide.....	1-5
System Memory.....	1-5
Memory Map.....	1-6
System Video.....	1-7
Parallel Interface.....	1-11
Serial Interface.....	1-12
NEC Versa 4000 Series Chip Set.....	1-12
Intel Pentium P54LM.....	1-12
Cache Controller, Address Logic, Data Controller.....	1-13
System Logic, IDE Interface, Peripheral Controller.....	1-13
Flash ROM.....	1-13
ROM BIOS.....	1-14
VGA Controller.....	1-14
Video Controller Architecture.....	1-15
Diskette Controller, Serial Interface, Parallel Interface.....	1-15
Keyboard Controller.....	1-15
PCMCIA Controller.....	1-15
Interrupt Controllers.....	1-16

Power Management Overview	1-17
System Power Management	1-17
Local Power Management.....	1-18
Plug and Play	1-18
Specifications.....	1-19

Section 2 Setup and Operation

Unpacking the System.....	2-1
Hardware Setup.....	2-1
Cable Connections	2-2
Operating Controls	2-3
Status Bar	2-4
Status Icons	2-5
Battery Status	2-5
Function Keys (Fn Keys).....	2-6
Smart Power Switch	2-6
Dip Switch.....	2-7
Power-on Self-Test (Post).....	2-8
POST Errors.....	2-9
Setup Utility	2-10
Accessing Setup.....	2-10
With an Error at POST	2-10
With No Errors at POST.....	2-10
Setup Screen.....	2-11
Setup Keys.....	2-11
Changing/Setting Parameter Settings.....	2-11
Parameter Options	2-13
Parameter Descriptions	2-14
Time/Date.....	2-14
Drives	2-14
Peripherals	2-14
Security	2-15
Power Savings	2-15
Security Options	2-16
System Password	2-16
Using the System Password.....	2-16
Keyboard Lock Hotkey.....	2-17

BIOS Update Utility (BUU).....	2-17
Precautions	2-17
Downloading the Update Utility.....	2-17
Using the Update Utility.....	2-18
Menu Functions	2-20
Power Sources.....	2-23
AC Adapter	2-23
Battery Power.....	2-24
Recharging the Battery Pack	2-24
Replacing the Battery Pack	2-24
Saving Battery Power	2-26
Automatic Power-Saving Features	2-27

Section 3 Illustrated Parts Breakdown

Appendix A Connector Locations and Pin Assignments

List of Figures

1-1	NEC Versa 4000 Series System Features	1-1
1-2	NEC Versa 4000 Series (Rear View).....	1-2
2-1	Power and I/O Connector Locations	2-2
2-2	Keyboard Panel Controls.....	2-3
2-3	Right Side Panel Controls	2-3
2-4	Status Bar Location	2-4
2-5	Status Bar Icons.....	2-5
2-6	Dip Switch Location	2-7
2-7	Dip Switch Settings.....	2-7
2-8	Connecting the AC Adapter	2-23
2-9	Battery Cover Latch Location	2-25
2-10	Battery Pack Replacement.....	2-25
2-11	Battery Bay Cover Replacement.....	2-26
3-1	NEC Versa 4000 Series Illustrated Parts Breakdown.....	3-3
A-1	System Board Connector Locations	A-1

List of Tables

1-1	NEC Versa 4000 Series System Memory Map	1-6
1-2	CRT Display Mode (CRT only).....	1-7
1-3	LCD Display Modes (640 x 480 TFT, Simultaneous CRT).....	1-9
1-4	LCD Display Modes (640 x 480 DSTN, Simultaneous CRT)	1-10
1-5	NEC Versa 4000 Series Chip Types and Technologies	1-12
1-6	NEC Versa 4000 Series Interrupt Level Assignments	1-16
1-7	Maximum Performance Default Settings.....	1-18
1-8	Specifications	1-19
2-1	I/O Connector Descriptions.....	2-2
2-2	Control and Switch Functions	2-4
2-3	FnKey Operations	2-6
2-4	POST Error Messages.....	2-9
2-5	Setup Key Functions	2-11
2-6	System Parameter Settings	2-13
2-7	Automatic Power-Saving Features	2-27
3-1	NEC Versa 4000 Series Field-Replaceable Parts.....	3-1
3-2	Option and Documentation Part Numbers	3-4
A-1	CPU Board Connectors.....	A-1
A-2	Keyboard/Mouse Connector Pin Assignments	A-1
A-3	Serial Port Connector Pin Assignments	A-2
A-4	CRT Connector Pin Assignments	A-2
A-5	Parallel Printer Pin Assignments	A-3
A-6	Expansion Connector Pin Assignments.....	A-4
A-7	Power Connector	A-8
A-8	Hard Disk Drive Connector.....	A-9
A-9	Diskette Drive Connector.....	A-10

Section 1

Technical Information

The NEC Versa 4000 series computers integrate the Intel® Pentium-75 MHz, or 90-MHz chips. The systems offer a unique transportable unit in the following configurations:

- NEC Versa 4000D — 75-MHz CPU, 540-MB hard disk drive, 10.4-inch Dual-Scan Super Twisted Nematic (DSTN) color LCD, 8-MB standard RAM, 1-MB video memory, 256-KB ROM
- NEC Versa 4000C — 75-MHz CPU, 540-MB hard disk drive, 10.1-inch thin-film transistor (TFT) color LCD, 8-MB standard RAM, 1-MB video memory, 256-KB ROM
- NEC Versa 4000H — 75-MHz CPU, 810-MB hard disk drive, 10.4-inch, high resolution, thin-film transistor (TFT) color LCD, 8-MB standard RAM, 1-MB video memory, 256-KB ROM
- NEC Versa 4050C — 90-MHz CPU, 810-MB hard disk drive, 10.1-inch thin-film transistor (TFT) color LCD, 8-MB standard RAM, 1-MB video memory, 256-KB ROM
- NEC Versa 4050H — 90-MHz CPU, 810-MB hard disk drive, 10.4-inch, high resolution, thin-film transistor (TFT) color LCD, 8-MB standard RAM, 1-MB video memory, 256-KB ROM
- NEC Versa 4000 — 120-MHz CPU, 1 gigabyte (GB) hard disk drive, 10.4-inch Super Video Graphics Array (SVGA) color LCD, 8-MB standard RAM, 1-MB video memory, 256-KB ROM

Figure Section 1-1 shows system features.

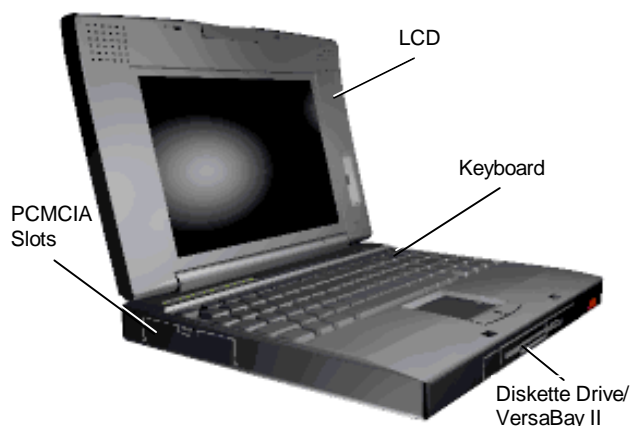

Figure Section 1-1 NEC Versa 4000 Series System Features

HARDWARE OVERVIEW

The base unit includes a color LCD panel, a 2 1/2-inch 540-MB, or 810-MB hard disk drive, a 3 1/2-inch, 1.44-MB diskette drive, a battery pack, and a PS/2 compatible 83-key keyboard. A 79-key keyboard is used for U.K. and Germany. The NEC VersaGlide touch-pad is positioned at the front of the keyboard, and takes the place of a mouse.

Multimedia features include built-in stereo speakers and a built-in microphone. Multimedia ports include line-in, line-out, headphone and external microphone.

One memory card slot is available for the addition of a 4-, 8-, 16-, or 32-MB capacity memory card. Two Personal Computer Memory Card International Association (PCMCIA) card slots, supported by the Cirrus Logic PD6722 PCMCIA controller, allow for the addition of either two PCMCIA Type 1/Type II cards or one PCMCIA Type III card.

Figure Section 1-2 shows the standard I/O interface ports on the system's rear panel. These include one 6-pin shared PS/2-style keyboard/mouse port, one 9-pin (RS-232C) serial port, one 25-pin enhanced printer (parallel) port, one 15-pin Super VGA CRT port, one Infrared (IR) port, one expansion connector, and one 4-pin power connector port.

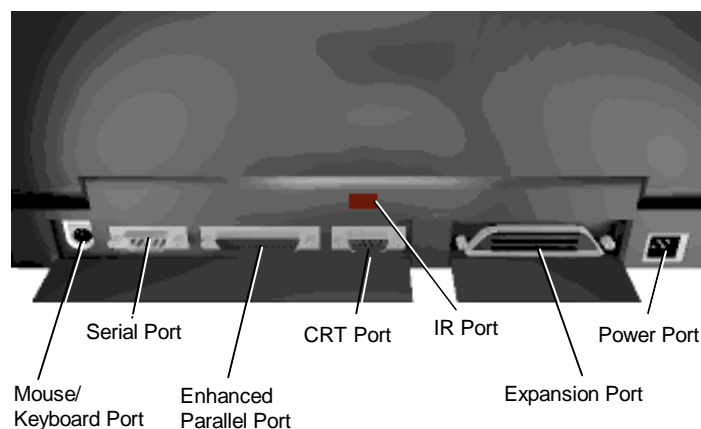

Figure Section 1-2 NEC Versa 4000 Series (Rear View)

Liquid Crystal Display (LCD)

The system integrates a built-in LCD. The LCD supports VESA Local (VL) bus video. The LCD operates with the Chips & Technologies 65545B1-5 VGA controller. The controller supports Super VGA. For more information on the 65545B1-5 or 65545B2-H VGA controller, read the description provided in the NEC Versa 4000 Series Chip Set subsection.

The NEC Versa 4000 series system features the following types of LCDs.

- TFT — 10.1-inch thin-film transistor backlit color LCD, 0.32 mm dot pitch, 18-bit digital interface, 640 x 480 resolution, 256,000 colors.
- DSTN — 10.4-inch dual-scan super twisted nematic color LCD, 0.33 mm dot pitch, 16-bit digital interface, 600 x 480 resolution, 256,000 colors, (64K colors on an external CRT).
- High Resolution TFT — 10.4-inch thin film transistor color LCD, 0.26 mm dot pitch, 18-bit digital interface, 800 x 600 resolution, 256,000 colors, (64K colors on an external CRT).

In addition, the CRT port on the system's rear panel allows the user to connect an optional monochrome or color external display to the system. The computer supports the LCD and external display simultaneously.

Power-saving features for controlling the LCD's backlighting include the ROM-based hot key Fn F5, and Auto Setup power management settings. See Section 2, Setup and Operation, for information on using these settings. In addition, the automatic LCD status sense feature conserves the backlight. When the LCD is closed the backlight shuts off, saving battery power.

CPU Board

The CPU board (75 Mhz, 90 MHz or 120 MHz) CPU board is an L-shaped board situated next to the audio ports. In addition to the CPU, this board houses the bridge battery and speaker. It controls important functions including power management, direct drive bus interface and memory management.

I/O Board

The I/O board (G8TUP) contains peripheral subsystems including serial, parallel and video ports. It is located underneath the sound board.

I/O board specifications are listed in Table Section 1-8 at the end of this section.

Sound Board

The sound board (G8UNA) provides the NEC Versa 4000 series system with its audio capabilities via line-in/line-out jacks, and headphone/microphone jacks. It is situated on top of the I/O board.

Infrared (IR) Front Assembly, Rear Assembly

Two IR assemblies are connected to the I/O board via connectors P10 and P11 respectively. One is located on the front of the NEC Versa, the second one is located on the rear of the NEC Versa.

Each IR assembly consists of a small board with infrared LEDs. The board allows the NEC Versa 4000 series computer to communicate with other infrared-ready computers. For example, the infrared ports allow the user to transfer files between the NEC Versa and an IR-equipped desktop, or print to an IR-equipped printer without using cables.

The NEC Versa 4000 series system ships with the rear IR assembly disabled and the front IR assembly disabled. When the NEC Versa 4000 is docked to the optional NEC Versa Docking Station 4000, the rear IR assembly is automatically disabled, and the front enabled.

Battery Pack

The system uses a rechargeable lithium-ion (Li-ION) battery as its transient power source. The battery pack installs in the compartment next to the standard diskette drive on the bottom of the Versa 4000. The battery uses 10.8 volts with a 2500 mAh capacity.

The battery pack powers the NEC Versa 4000 for approximately 5 hours with Power Management or 2.5 hours without Power management. In addition, the battery pack lets the user know how much battery power is available via the LEDs on the front of the system, or the battery gas gauge in the power panel.

When battery power is getting low, connect the AC adapter to a wall outlet and recharge the battery. It takes 2.5 hours to recharge the battery pack when the system is powered off, (Quick Charge). It takes 2.5 hours to recharge the battery while the system is powered on, (Normal Charge).

CMOS Battery

The lithium battery (3.0 Volts, 280 mAh capacity) is attached to connector P12 on the CPU board. It provides battery backup and prevents data loss in the system's complementary metal oxide semiconductor (CMOS) RAM. This memory area contains information on the system's configuration like date, time, drives, and memory. The CMOS battery lasts approximately two years.

Bridge Battery

The bridge battery saves the memory contents and system status for up to 5 minutes while in Suspend mode. It is connected to the CPU board via P8. The AC adapter maintains voltage in the bridge battery when the system is powered on or off. The bridge battery provides 6 Volts, 60 mA.

PCMCIA Slots

The Versa 4000 provides a 5 volt, or 3.3 volt interface for either two Type I/Type II PCMCIA cards, or one Type III PCMCIA card.

Diskette Drive and the NEC VersaBay II

A standard 1.44-MB diskette drive comes installed in the VersaBay II slot on the front of the system. The VersaBay II expansion slot allows the user to replace the standard diskette drive with a number of different NEC options including a CD-ROM reader, a second battery pack, or an additional hard disk drive using the release latches on the bottom of the unit.

Keyboard

The built-in, 83-key keyboard (U.S) or 79-key keyboard (UK and Germany) uses the standard QWERTY format. The keyboard provides 12 function keys and 8 cursor control keys, with an Fn key for ROM-based key functions. The numeric keypad is embedded in the standard key layout.

NEC VersaGlide

The NEC VersaGlide is a built-in mechanism that functions as the system's mouse. It controls the on-screen pointer (cursor). To use the VersaGlide, glide your finger across the NEC VersaGlide pad, and the cursor follows. The buttons on either side of the NEC VersaGlide allow the user to select or deselect menu items. Tap and double-tap are supported on the VersaGlide pad.

The NEC VersaGlide is the system's default pointing device unless a PS/2 mouse is installed. If an external mouse is installed, then the NEC VersaGlide is deactivated. A serial mouse is not supported.

SYSTEM MEMORY

The system board provides 8-MB of standard random access memory (RAM). The NEC Versa 4000 operates with 4 banks. Banks 0 to 1 are used for the standard 8-MB (with interleaved access support). Banks 2 to 4 are used for memory expansion (without interleaved access support).

Optional memory cards with a value of 4-, 8-, 16-, or 32-MB can be added to increase system memory up to a maximum of 40-MB. In addition, 256 KB of read-only memory (ROM), 1 x 28F020, enables the system BIOS to be flashed.

Cache RAM is available with L1 write-back access support providing 8 KB for code, 8 KB for data. L2 write-through access support providing 256 KB.

Memory Map

The system supports system and video shadowing, both controlled through complementary metal oxide semiconductor (CMOS). The system supports BIOS as a cacheable area with write protection. Table Section 1-1 lists the system's memory map.

To view a more complete breakdown, and to determine available space for the addition of drivers etc., type **MSD** at the DOS prompt and press **Enter**.

Table Section 1-1 NEC Versa 4000 Series System Memory Map

Memory Space	Size	Function
0027FFFFh-00C0000h	40 MB	Reserved for Extended Memory
000BFFFFh-00010000h	8 MB	Base Memory
000FFFFFh-000F0000h	64 KB	ROM BIOS
000EFFFFh-000CA000h	152 KB	Upper Memory Block (UMB)
000C9FFFh-000C0000h	40 KB	Video ROM BIOS
000BFFFFh-000A0000h	128 KB	Video Memory
0009FFFFh-0000000h	640 KB	Conventional Memory

SYSTEM VIDEO

The system's LCD operates using the Chips and Technologies 65545B1-5 or 65545B2-H VGA Controller. Video signals travel from the controller through the system's 15-pin D-SUB connector using 5 volts.

System video integrates a 32-bit VL-bus interface using local bus video. The system ships with 1 MB Video RAM (VRAM). It also supports video modes up to 1024 x 768 with 256 colors in CRT mode.

Table Section 1-2 lists CRT display modes..

NOTE: Interlaced video modes are represented with the letter I in the table below.

Table Section 1-2 CRT Display Mode (CRT only)

Mode (Hex)	Display Mode	Colors	Text Display	Resolution	Font	Refresh Rate
0, 1	Text	16	40x25	320x200	8x8	70
0*, 1*	Text	16	40x25	320x200	8x14	70
0**, 1**	Text	16	40x25	360x400	9x16	70
2, 3	Text	16	80x25	640x200	8x8	70
2*, 3*	Text	16	80x25	640x350	8x14	70
2**, 3**	Text	16	80x25	720x400	9x16	70
4,5*	Graphics	4	40x25	320x200	8x8	70
6	Graphics	2	80x25	640x200	8x8	70
7*	Text	Mono	80x25	720x350	9x14	70
7**	Text	Mono	80x25	720x400	9x16	70
D	Planar	16	40x25	320x200	8x8	70
E	Planar	16	80x25	640x200	8x8	70
F	Planar	Mono	80x25	640x350	8x14	70
10	Planar	16	80x25	640x350	8x14	70
11	Planar	2	80x30	640x480	8x16	60
12	Planar	16	80x30	640x480	8x16	60
12***	Planar	16	80x30	640x480	8x16	74
13	Packed Pixel	256	40x25	320x200	8x8	70
20	4-bit linear	16	80x30	640x480	8x16	60

Table Section 1-2 CRT Display Mode (CRT only)

Mode (Hex)	Display Mode	Colors	Text Display	Resolution	Font	Refresh Rate
22	4-bit linear	16	100x37	800x600	8x16	60
24	4-bit linear	16	128x48	1024x768	8x16	60
24l	4-bit linear	16	128x48	1024x768	8x16	43
30	8-bit linear	256	80x30	640x480	8x16	60
30***	8-bit linear	256	80x30	640x480	8x16	74
32	8-bit linear	256	100x37	800x600	8x16	60
32***	8-bit linear	256	100x37	800x600	8x16	74
34	8-bit linear	256	128x48	1024x768	8x16	60
34l	8-bit linear	256	128x48	1024x768	8x16	43
40	15-bit linear	32K	80x30	640x480	8x16	60
41	16-bit linear	64K	80x30	640x480	8x16	60
50	24-bit linear	16	80x30	640x480	8x16	55
60	Text	16	132x25	1056x400	8x16	68
61	Text	16	132x50	1056x400	8x16	68
6A, 70	Planar	16	100x37	800x600	8x16	60
6A*** 70***	Planar	16	100x37	800x600	8x16	74
72, 75	Planar	16	128x48	1024x768	8x16	60
72l, 75l	Planar	16	128x48	1024x768	8x16	43
78	Packed Pixel	256	80x25	640x400	8x16	70
79	Packed Pixel	256	80x30	640x480	8x16	60
79***	Packed Pixel	256	80x30	640x480	8x16	74
7C	Packed Pixel	256	100x37	800x600	8x16	60
7C***	Packed Pixel	256	100x37	800x600	8x16	74

Table Section 1-2 CRT Display Mode (CRT only)

Mode (Hex)	Display Mode	Colors	Text Display	Resolution	Font	Refresh Rate
7E1	Packed Pixel	256	128x48	1024x768	8x16	43
7E1	Packed Pixel	256	128x48	1024x768	8x16	60

*EGA Extension

**VGA Extension

***High Refresh Modes

Table Section 1-3 lists 640 x 480, TFT simultaneous LCD/CRT display modes.

Table Section 1-3 LCD Display Modes (640 x 480 TFT, Simultaneous CRT)

Mode (Hex)	Display Mode	Colors	Text Display	Resolution	Font	Refresh Rate
0,1	Text	16	40x25	320x200	8x8	60
2,3	Text	16	80x25	640x200	8x8	60
0*, 1*	Text	16	40x25	320x350	8x14	60
2*, 3*	Text	16	80x25	640x350	8x14	60
0**, 1**	Text	16	40x25	320x400	8x16	60
2**, 3**	Text	16	80x25	640x400	8x16	60
4, 5	Graphics	4	40x25	320x200	8x8	60
6	Graphics	2	80x25	640x200	8x8	60
7*	Text	Mono	80x25	640x350	8x14	60
7**	Text	Mono	80x25	640x400	8x16	60
D	Planar	16	40x25	320x200	8x8	60
E	Planar	16	80x25	640x200	8x8	60
F	Planar	Mono	80x25	640x350	8x14	60
10	Planar	16	80x25	640x350	8x14	60
11	Planar	2	80x30	640x480	8x16	60
12	Planar	16	80x30	640x480	8x16	60
13	Packed Pixel	256	40x25	320x200	8x8	60
20	4-bit linear	16	80x30	640x480	8x16	60

Table Section 1-3 LCD Display Modes (640 x 480 TFT, Simultaneous CRT)

Mode (Hex)	Display Mode	Colors	Text Display	Resolution	Font	Refresh Rate
30	8-bit linear	256	80x30	640x480	8x16	60
40	15-bit linear	32K	80x30	640x480	8x16	60
50	24-bit linear	16 M	80x30	640x480	8x16	55
41	16-bit linear	64K	80x30	640x480	8x16	60
78	Packed Pixel	256	80x25	640x400	8x16	60
79	Packed Pixel	256	80x30	640x480	8x16	60

*EGA Extension

**VGA Extension

Table Section 1-4 lists LCD display modes, 640 x 480 DSTN, simultaneous CRT display modes.

Table Section 1-4 LCD Display Mode (640 x 480 DSTN, Simultaneous CRT Display)

Mode (Hex)	Display Mode	Colors	Text Display	Resolution	Font	Refresh Rate
0, 1	Text	16	40x25	320x200	8x8	60
2, 3	Text	16	80x25	640x200	8x8	60
0*, 1*	Text	16	40x25	320x350	8x14	60
2*, 3*	Text	16	80x25	640x350	8x14	60
0**, 1**	Text	16	40x25	320x400	8x16	60
2**, 3**	Text	16	80x25	640x400	8x16	60
4,5	Graphics	4	40x25	320x200	8x8	60
6	Graphics	2	80x25	640x200	8x8	60
7*	Text	Mono	80x25	640x350	8x14	60
7**	Text	Mono	80x25	640x400	8x16	60
D	Planar	16	40x25	320x200	8x8	60
E	Planar	16	80x25	640x200	8x8	60

Table Section 1-4 LCD Display Mode (640 x 480 DSTN, Simultaneous CRT Display)

Mode (Hex)	Display Mode	Colors	Text Display	Resolution	Font	Refresh Rate
F	Planar	Mono	80x25	640x350	8x14	60
10	Planar	16	80x25	640x350	8x14	60
11	Planar	2	80x30	640x480	8x16	60
12	Planar	16	80x30	640x480	8x16	60
13	Packed Pixel	256	40x25	320x200	8x8	60
20	4-bit linear	16	80x30	640x480	8x16	60
30	8-bit linear	256	80x30	640x480	8x16	60
78	Packed Pixel	256	80x25	640x400	8x16	60
79	Packed Pixel	256	80x30	640x480	8x16	60

*EGA Extension

**VGA Extension

PARALLEL INTERFACE

The system's parallel interface integrates National Semiconductor's PC87334 chip. It uses a 25-pin D-subconnector. The port is located on the system's rear panel.

The modes of operation available for a PC87334 chip are

- compatibility mode
- nibble mode
- byte mode
- Enhanced Capabilitied Port (ECP)
- Enhanced Parallel Port (EPP).

The user selects between three parallel interface modes using Auto Setup. These include unidirectional, bidirectional or enhanced. Unidirectional mode sends data output from the standard ISA port only. Bidirectional mode sends data using the standard ISA port or PS/2 technology. Enhanced mode enables high speed data transmission to occur using either the unidirectional or bidirectional modes.

The parallel port address is 378h and the interrupt level is IRQ07. Pin locations for the parallel interface are listed in Appendix A.

SERIAL INTERFACE

The RS-232C serial port is a 9-pin connector on the system's rear panel. The serial port consists of a 16550 compatible serial port controller with a programmable baud rate up to 115,200 bps. The serial port connects an RS-232C device or an external modem. The serial port address is 3F8h and the interrupt level is IRQ04.

NEC VERSA 4000 SERIES CHIP SET

Refer to Table Section 1-5 for a quick summary of the chip types used in the system. See the Abbreviations section at the beginning of this manual for a translation of chip technologies.

Table Section 1-5 NEC Versa 4000 Series Chip Types and Technologies

Chip	Manufacturer	Description	Technology
Intel Pentium P54LM	Intel	75 MHz, 90-MHz, 120-MHz CPU	320-pin TCP
PT80C732 or PT80C733	Pico Power	Cache Controller, Address Logic and Data Controller	176-pin TQFP and 144-pin TQFP
PT86C718	Pico Power	System Logic AT Base, IDE Interface, Peripheral	176-pin TQFP
N28F020-150	Intel	256k x 8 Flash ROM	32-pin PLCC
C&T65545B1-5	Chips & Technologies	VGA Controller	208-pin QFP
PC87334	National Semiconductor	Diskette Controller, IDE, Parallel Interface	100-pin FQFP
M38813E4HP	Mitsubishi	Keyboard Controller	64-pin TQFP
PD6722	Cirrus Logic	PCMCIA Controller	208-pin TQFP
ES688S	ESS Technology	Sound Integrated Circuit	100-pin TQFP

Intel Pentium P54LM

The 75 MHz, 90 MHz or 120 MHz Intel Pentium microprocessor used in the NEC Versa 4000 series computer is built on Intel's advanced 3.3V BiCMOS silicon technology. The CPU has on-chip dual-processing, a local multiprocessor interrupt controller, and power management features. NEC adopted the chip specifically for its pipelined Floating Point Unit (FPU), and local interrupt management.

Cache Controller, Address Logic, Data Controller

The Golden Gate PT80C732 and PT80C733 Pico Power controller provides a dual-chip structure that connect the Pentium processor to the industry-standard 486 bus. The chip increases data reliability by integrating the following:

- 8-level write buffer
- extends battery life and efficient thermal management
- improved performance for DRAM and VL bus peripherals.

System Logic, IDE Interface, Peripheral Controller

The PT86C718 Pico Power chip consists of a 176-pin thin-quad flat-package. This chip controller supports fast graphics and I/O processing. The system logic controller adds the following features:

- built-in level 2 cache controller
- integrated active power management
- integrated battery management
- high performance DRAM controller.

Flash ROM

The N28F020 flash ROM is a 32-pin, plastic lead chip carrier (PLCC). The chip allows easy updates to the system's BIOS if needed. More specifically, the ROM is flashed electronically, installing the latest BIOS revisions to the system. It is possible to reprogram the BIOS up to 100,000 times. See Section 2, Setup and Operation, for BIOS update procedures.

The N28F020 provides the system upgrade capability as well as the following:

- 256 KB memory
- Quick-Pulse Programming Algorithm
- 150 nanoseconds (ns) maximum access time
- ETOX Nonvolatile flash technology
- CMOS low power consumption

ROM BIOS

The system uses a Flash ROM known as the system's ROM BIOS to store machine language programs. The BIOS size is 256 KB, consisting of the system utility (PCMCIA, Auto Setup), system BIOS, video BIOS, and power management.

The BIOS programs execute the power-on self-test (POST), initialize CPU controllers, and interact with the LCD indicator panel, diskette drive, hard drive, communication devices and peripherals. The system BIOS also contains Auto Setup and provides VGA controller support. The ROM BIOS is copied into RAM (shadowing) for optimum performance.

The ROM BIOS contains both the system and video BIOS. The system BIOS is located in the upper portion of the device, video BIOS is located in the lower portion. System BIOS is located between F000h-FFFFh.

The BIOS often changes after the product release to provide enhanced features or bug fixes. To acquire the latest BIOS release, the ROM is flashed electronically allowing the BIOS update to occur without removing the ROM. See Section 2, Setup and Operation, for BIOS upgrade procedures.

VGA Controller

The video architecture is maintained using the C&T65545B1-5 or C&T65545B2-H Controller and support logic. The controller supports video standards including EGA and CGA.

This powerful circuitry provides the following features for the system via the controller and LCD:

- 1-MB VRAM
- true-color and high-color display capability with 640 x 480 resolution
- supports external CRT resolutions up to 1024 x 768
- hardware windows acceleration
- bit boundary block transfer
- simultaneous LCD/CRT display in 640 x 480 VGA display mode
- optional frame memory
- high resolution graphics support.

Video Controller Architecture

The video controller architecture is broken down into several modules. The five significant modules include the sequencer, CRT controller, graphics controller, attribute controller and dithering engine.

For example, the sequencer manages CPU and display memory timing. The CRT controller controls sync and timing signals. The graphics controller permits the flow of communication between the CPU data bus and the 32-bit internal data bus. The attribute controller produces a 4-bit wide video data stream that refreshes the display.

Diskette Controller, Serial Interface, Parallel Interface

The PC87334 chip is a 100-pin plastic Thin Quad Flat Plastic (TQFP) chip. The controller changes 8-bit parallel data into serial data and writes the data to the diskette. Conversely, the serial data is transmitted from the diskette into parallel data, where it remains until the read operation takes place.

Additional PC8733 chip operations include:

- ISA compatibility
- low-power CMOS with enhanced power-down mode

Keyboard Controller

The keyboard controller (M38813E4HP) supports a PS/2-style keyboard, mouse and security features such as keyboard hot keys and password. Refer to Appendix A for keyboard interface connector pin assignments.

When data is written to the output buffer, the controller generates an interrupt, and requests the CPU to receive the data. The controller automatically adds an even parity bit to the data sent and waits for a response. The device must acknowledge that the data was successfully received by sending a response to the controller for each byte of data received.

PCMCIA Controller

The controller (PD6722) interfaces with the ISA bus, PCMCIA card socket and configuration registers to provide:

- memory address mapping, I/O address mapping
- power management for each PCMCIA card socket, controlled through power and RESETDRV control registers
- the elimination of interrupt conflicts using interrupt steering.

Interrupt Controllers

Using interrupts, it is possible to change the code sequence. To change the sequence, reassign the interrupt-levels. Fifteen interrupts can be used with a cascade connection of 8259INTC x 2.

Interrupt-level assignments 0 through 15 are listed in Table Section 1-6, in order of decreasing priority.

Table Section 1-6 NEC Versa 4000 Series Interrupt Level Assignments

Controller Master/Slave	Priority	Name	Device
Master	0	IRQ00	Counter/Timer 1
Master	1	IRQ01	Keyboard
Master	2	IRQ02	INT output from controller 2
Slave	3	IRQ08	Real-time Clock
Slave	4	IRQ09	Reserved
Slave	5	IRQ10	Reserved
Slave	6	IRQ11	Reserved)
Slave	7	IRQ12	PS/2 Mouse
Slave	8	IRQ13	Math Coprocessor (built into CPU)
Slave	9	IRQ14	Hard Disk Controller 1
Slave	10	IRQ15	Reserved (second IDE on optional docking station)
Master	11	IRQ03	IR Port
Master	12	IRQ04	Serial Port 1
Master	13	IRQ05	Reserved (sound)
Master	14	IRQ06	Diskette Drive Controller 1
Master	15	IRQ07	Parallel Port 1

POWER MANAGEMENT OVERVIEW

The NEC Versa 4000 series system uses power management features to prolong system battery life.

The CPU implements a System Management Interrupt (SMI) function that works transparently with the operating system and application software. When activated, the processor mode changes to real mode. Unique “SM-RAM” containing power management software is mapped at address 30000h-3FFFFh. This activity is inherent to the system and does not require any adjustment to the operating system or application software.

The power management program is located in ROM at location EA000h-0EFFFh. In on-board DRAM, the software is physically allocated at 0D0000h-0DFFFFh.

Use Auto Setup to select specific power management options. For information on how to select these options, see Section 2.

NOTE: Some power management features are unavailable when an NEC docking station is connected.

System Power Management

The system power management consists of the following operation modes. These modes are:

- Active Mode — In active mode, the system uses maximum power. It operates with the default clock speed. The system continues to run at this speeds unless overwritten by the power management features.
- Suspend Mode — When the system is powered on, but not in use it enters into Automatic Suspend mode after a specified amount of time (default timeout is 5 minutes). This shut-down mechanism conserves system power while allowing the user to return to complete the work at any time.

Or, the system can be put into Suspend mode using the suspend button. Press the suspend button to activate Suspend mode; press it again to resume active mode.

Suspend mode causes the CPU power down, local devices to shut down, and register values to be stored in RAM. System RAM is put into a slow refresh state.

Local Power Management

Use Auto Setup to select one of four power management settings for local devices. These include Longest Battery Life, Highest Performance, Custom Setup, and Power Management Off. The power management levels are also available during AC operation. The NEC Versa 4000 computer ships with Longest Battery Life as the default power management setting. See Section 2 for specific procedures on using Auto Setup to select the power management settings.

When set to Longest Battery Life, CMOS will set local device timeout values, a local standby timeout value, and a suspend timeout value to ensure the longest battery life. The Highest Performance setting selects CMOS values that will provide minimal energy savings and a shorter battery life. The custom settings enable end-users to set the timeout values of their choice. The Power Management Off selection terminates all power management timers.

Local device timers in the system control power consumption in the LCD and Hard Disk Drive. Table Section 1-7 shows NEC Versa 4000 series Maximum Performance default power management timers.

Table Section 1-7 Maximum Performance Default Settings

Power Management Mode	Automatic Suspend	Hard Disk Timer	LCD Panel Timer
Longest Battery Life	10 minutes	30 seconds	2 minutes
Highest Performance	30 minutes	10 minutes	10 minutes
Custom	15 minutes	15 seconds	2 minutes

PLUG AND PLAY

The NEC Versa 4000 has a Plug and Play functionality. This means you can suspend the system, add an external keyboard, mouse, or monitor, and when you resume working, the NEC Versa 4000 recognizes the devices that have been connected to it. Similarly, you can remove external devices in Suspend mode and the NEC Versa 4000 notices the difference when resumed.

NOTE: A plug and play operating system and BIOS are required for this option to work.

SPECIFICATIONS

Table Section 1-8 provides a complete list of NEC Versa 4000 series system specifications.

Table Section 1-8 Specifications

Item	Specification
Chassis Configuration	
Size	Width: 11.69 in. (297 mm)
	Depth: 9.4 in. (240.5 mm)
	Height: 2.1 in. (53.5 mm)
	NEC Versa 4000 (DSTN)
	Weight: 6.25lb (2.84 kg) (Exact weight depends on options)
	NEC Versa 4000/4050 (TFT)
Weight:	6.58 lb (2.98 kg) (Exact weight depends on options)
	NEC Versa 4000/4050 (High Resolution)
	6.34 lb (2.87 kg) (Exact weight depends on options)
Keyboard	PS/2 compatible, 83-key standard (79-key for UK and Germany) (includes Fn Key for ROM-based functions)
Device Slots	Two PCMCIA slots that support up to two optional cards-oriented one on top of the other
	One 3 1/2-inch x 0.75-inch high slot
	One 3 1/2-inch x 0.75-inch high slot, front access, for standard 1.44 diskette drive
	One memory slot for optional memory card, located on bottom of system, in the hard disk drive bay
Power	100 to 240 Vac at 50 or 60 Hz
	Output Voltage — 13.5 V DC, 3 A (40.5 W)
Battery Pack	Weight — .64 lb (0.29 kg)
	Voltage — 10.8 V
	Capacity — 2500 mA
	Battery Life — Approximately 3 to 5 hours (depending on model and power management settings)
	Bridge Battery — Backs up memory contents up to 5 minutes using Suspend Mode

Table Section 1-8 Specifications

Item	Specification
Front Panel Controls	Power Button
	Suspend/Resume Button
	LCD Panel Sensor
	Brightness Control
	Contrast Control (DSTN model only)
LEDs	Power LED
	Battery Status LEDs
System Board	
CPU	Intel Pentium P54LM
Clock Speed	75 MHz, 90 Mhz or 120 MHz
CPU Bus Speed	50 MHz or 60 Mhz, 60 MHz
Flash ROM	256 KB: N28F020
Connector Support	6-pin PS/2 External Keyboard/Mouse Connector
	9-pin Serial Connector
	25-pin Parallel Connector
	198-pin Expansion Connector
	15-pin CRT Connector
	2-port Infrared Assembly
	3-pin Mono MIC IN
	3-pin Stereo Headphones
	3-pin Stereo Line In
	3-pin Stereo Line Out
6-pin DC-In Power Connector	
Memory	
System Memory	8 MB high-speed interleaved access, 70 ns
Optional	One memory slot available for memory cards on underside of system.
	Expandable in 4-MB, 8-MB, 16-MB, 32-MB
	Maximum 40 MB
Video RAM	1 MB

Table Section 1-8 Specifications

Item	Specification
Video Interface (VGA)	
	10.4-inch DSTN backlit color Resolution — 640 x 480 pixels Dot Pitch — 0.33 mm Colors — 256,000
	10.1-inch TFT backlit color Resolution — 640 x 480 pixels Dot Pitch — 0.32 mm Colors — 256,000
	10.4-inch High Resolution TFT CCFT backlit color Resolution — 800 x 600 pixels Dot Pitch — 0.26 mm Colors — 256,000
Internal Device Support	
Diskette Drive	3 1/2-inch, 1.44-MB (thin-height)
Hard Disk Drives	IDE interface (built-in), 2 1/2-inch x 1-inch high (thin-height) System ships with the 540-MB, 810-MB or 1-GB hard disk drive
External Device Support	
CRT	Displays up to 1024 x 768 resolution x 256 colors
Mouse	PS/2-compatible mouse
Keyboard	PS/2-compatible
Software	
Standard	MS-DOS® version 6.22 (also provided on diskette) Windows® for Workgroups version 3.11, or Window 95 Power Management Utility SystemSoft PCMCIA Drivers with CardWizard
Recommended Environment	
Operation	Temperature: 41° to 104°F (5° to 35°C) Relative Humidity: 20% to 80% (No condensation)
Storage	Temperature: -4° to 104°F (-20° to 40°C) Relative Humidity: 20% to 80% (No condensation)

Table Section 1-8 Specifications

Item	Specification
Administrative Compliance	U.S.: FCC, UL Canada: CSA, DOC Germany: VDE, TUV, CE Australia: AS for AC adapter only
Other Compliance	PC95 Compliance Energy Star VESA & PnP VESA PnP ISA

Section 2

Setup and Operation

This section provides setup and operation information for the NEC Versa 4000 series system (including cabling, power-on verification and using Auto Setup).

UNPACKING THE SYSTEM

Find an area away from devices that generate strong magnetic fields (electric motors, transformers, etc.). Place the shipping carton on a sturdy surface and carefully unpack the system. The carton contents include the system, AC adapter, AC power cord, battery, software diskettes, and user documentation.

HARDWARE SETUP

When connecting power and signal cables, do the following.

1. Make sure that the system is powered off.

The power switch turns the system on or off. Slide the switch right to turn it on, slide the switch again to turn it off.

2. Observe connector alignment marks and keys (when present).
3. Connect the AC adapter cable to the power connector port as shown in Figure Section 2-8.
4. Connect the end of the power cord to the AC input connector on the AC adapter.
5. Connect the other end of the power cord to an AC power source.

NOTE: If operating the system on DC power, verify that the system has a charged battery pack installed. For information on connecting the AC adapter to recharge the battery pack during or after use, see “Recharging the Battery Pack” in the following section.

6. Ensure that all connections are properly seated and secure.
7. When removing or replacing cables, grasp and pull gently on the attached connectors.

Cable Connections

Figure Section 2-1 shows the external connectors for the system. Where appropriate, secure cables by tightening the cable holding screws.

Table Section 2-1 describes the I/O connectors on the rear of the system. For pin assignments, see Appendix A.

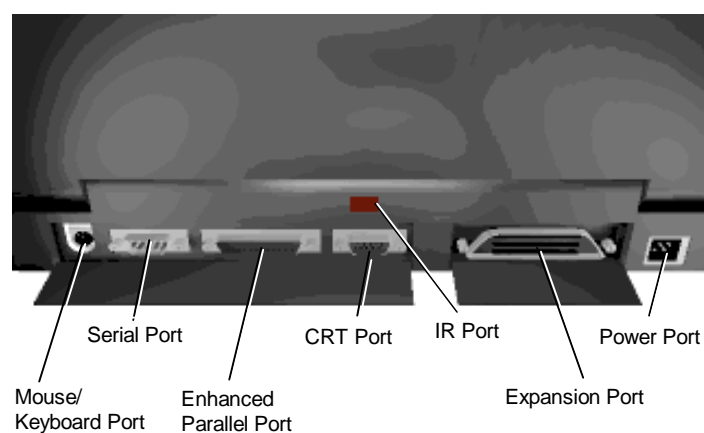

Figure Section 2-1 Power and I/O Connector Locations

Table Section 2-1 I/O Connector Descriptions

I/O Connector	Function
Mouse/Keyboard Port	Connects to a PS/2-style mouse, or a 101-key, external PS/2-style keyboard.
Serial Port	Connects to an RS-232C device.
Enhanced Parallel Port	Connects to a 25-pin parallel printer.
CRT Port	Connects to a 15-pin external CRT.
IR Ports	The infrared ports allow the user to transfer files between the NEC Versa and an IR-equipped desktop, or print to an IR-equipped printer without using cables.
Expansion Connector	Provides a 75-pin connector to attach the optional NEC Docking Station 4000.
Power Connector	This 4-pin connector provides an interface for the AC adapter. The AC adapter is then connected to a wall outlet via the AC power cord.

OPERATING CONTROLS

The following section describes system controls, the LEDs, and function keys.

Refer to Figure Section 2-2 and Figure Section 2-3 to locate system controls and switches. Table Section 2-2 describes the controls.

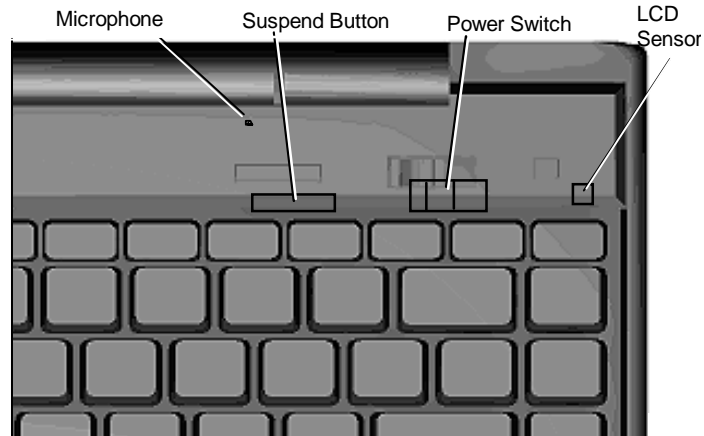

Figure Section 2-2 Keyboard Panel Controls

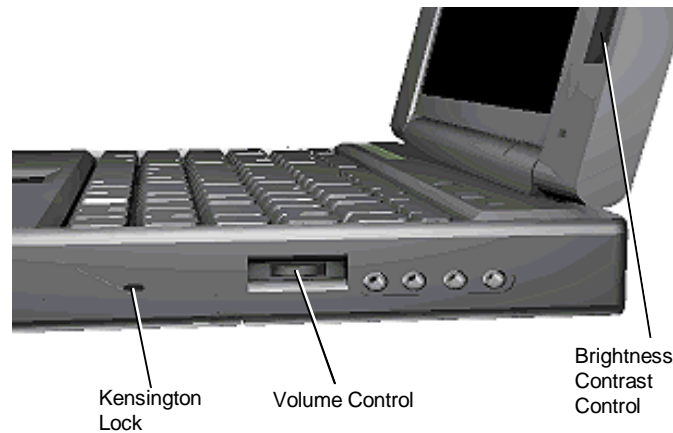

Figure Section 2-3 Right Side Panel Controls

Table Section 2-2 Control and Switch Functions

Control	Function
Microphone	Allows the user to record monophonic sound directly into the NEC Versa 4000 system.
Suspend/Resume Button	Press the button for Suspend mode, press again to resume active mode.
Power Switch	Turns the system on when pushed to the right. Turns the system off when pushed to the right again..
LCD Sensor	Senses when the LCD panel is closed, and turns off the panel.
Kensington Lock	Enables the user to add an optional Kensington Lock.
Volume Control	Controls the speaker volume.
Contrast Control	Adjust the dark/light background on the LCD using this switch (on DSTN models only).
Brightness Control	Move the control upward to increase brightness on the LCD. Lower the control to decrease brightness on the LCD. A brighter adjustment uses more battery power. For longer battery life, decrease the brightness.

Status Bar

The NEC Versa 4000 status bar is located in the upper left corner of the keyboard panel. Figure Figure Section 2-4 shows the status bar.



Figure Section 2-4 Status Bar Location

Status Icons

The NEC Versa 4000 uses eight icons to let the user determine system status, see Figure Section 2-5.

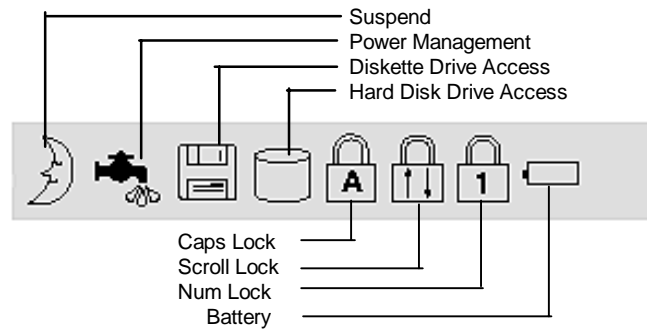

Figure Section 2-5 Status Bar Icons

- Suspend — appears when the system is in Suspend mode.
- Power Management — shows current power management mode.
- Diskette — appears when the NEC Versa writes data to, or retrieves data from a diskette.
- Hard Disk — shows when the NEC Versa writes data to, or retrieves data from the system's hard disk.
- Caps Lock — appears when caps lock is used.
- Scroll Lock — indicates that scroll lock is used.
- Num Lock — indicates that Num lock is used.

Battery Status

Battery icons (bars) also appear in the status bar. These bars represent the remaining battery charge when the system is in use as follows:

- 4 bars signify a 76-100% charge
- 3 bars signify a 51-75% charge
- 2 bars signify a 26-50% charge
- 1 bar signifies a 0-25% charge

Function Keys (Fn Keys)

Function keys set specific system parameters and are built into the ROM. When using these keys, simultaneously press **Fn** and the corresponding function key. See Table Section 2-3 for a list of ROM-based hot keys. ROM-based hot keys change system parameters temporarily. Hot Key functions operate until the system is turned off or reset.

Table Section 2-3 FnKey Operations

Key	Function
Fn F2	Highlight, toggles the contrast between standard and full.
Fn F3	LCD/CRT, toggles between LCD and CRT modes.
Fn F5	Backlight, toggles the backlight between standard and full
Fn F6	Speaker Volume, turns speaker volume on/off.
Fn F7	Power Management (P/M), sets P/M levels to highest performance, longest battery life, custom values, or off.
Fn F12	Scroll/Lock On/Off

Smart Power Switch

Provides an automatic feature that prevents you from accidentally powering off the NEC Versa 4000, and losing your data while your system is in Suspend mode. The smart power switch senses that the system is in Suspend mode and prevents you from directly powering off the system when you press the power switch.

To power off the system from Suspend mode,

1. Press the Suspend/Resume button to make the system active.
2. Press the power button to turn off the system.

Dip Switch

A four-position dip switch is located in the hard disk drive bay, under the hard disk drive, and next to the memory slot. Figure Section 2-6 shows the dip switch location. Figure Section 2-7 shows dip switch default settings.

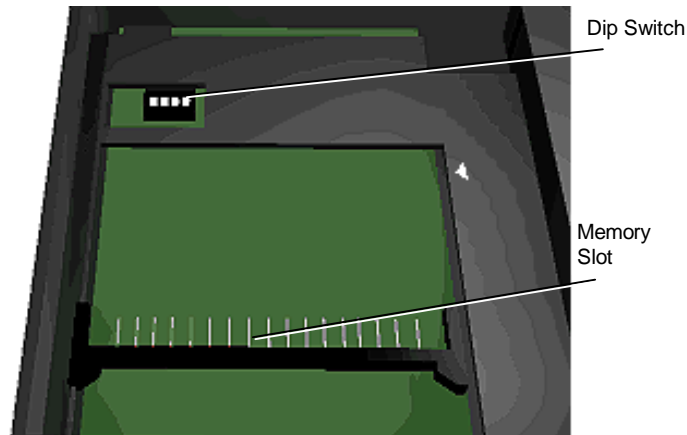

Figure Section 2-6 Dip Switch Location

NOTE: The asterisk (*) below indicates the default setting.

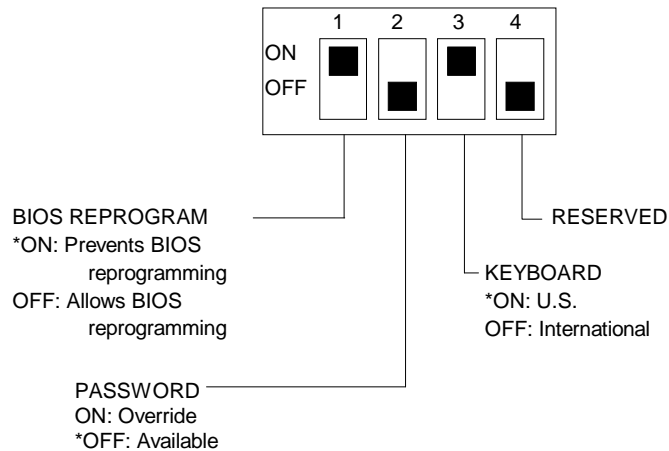

Figure Section 2-7 Dip Switch Settings

POWER-ON SELF-TEST (POST)

Each time the system is powered on, the system checks the working status of components through an automatic power-on self-test (POST). The test checks the system configuration for any discrepancies. One beep means that POST is successful. If any problems in data transfer or hardware exist, an error message appears.

If the message is an Invalid Configuration message, press **F2** to enter the Setup utility. The system collects Setup data and lists the changes detected in the current parameter settings. Press **Enter** to review the settings, and make any necessary corrections. For more complete information, see “Using Setup to Select Parameters.”

If no error messages appear but the system still malfunctions, check the items in the list below.

- The power switch for each peripheral is on.
- All cables and power cords are tightly connected.
- The electrical outlet is working.
- The brightness and contrast controls for the display are adjusted properly.
- All options have been properly installed.

NOTE: If the system parameters (date, time, options, etc.) have not been entered for the present configuration, enter them when you complete the setup procedures (see “System Parameters” in this section).

POST Errors

Error messages will appear during POST when configuration information does not match the settings stored in memory. Error message will also appear if the system loses the configuration information due to hardware failure.

Refer to Table Section 2-4 for a description of POST error messages.

Table Section 2-4 POST Error Messages

Message	Action
Diskette drive n failure	Drive n does not work or is improperly connected (drive n meaning either drive A or B). Check that drive n is securely connected and power is on. Press F2 to start Setup to check the diskette drive parameters. If a problem still exists, drive n might need repair.
Diskette read failure - press F2 to run Setup. Press any other key to retry boot.	Remove the diskette from drive A and press F2 to start the system from the hard disk. Or, insert a bootable disk in drive A and press F2 .
Non-system disk or disk error; replace and press any key when ready.	Remove the diskette from drive A and press any key to start the system from the hard disk.
No boot device available - press F2 to run Setup.	Press F2 , start Auto Setup and change the hard disk type to the correct setting. Exit and save Auto Setup.
Invalid configuration information - run Setup	One or more system configuration parameters are not properly set. Use Setup to set them correctly. Exit and save to update the parameters. Connect the AC adapter to charge the battery.
Real-time clock failure	Set time and date using Setup. Exit and save to update the parameters. Connect the AC adapter to charge the CMOS battery.
Time-of day not set - run Setup	Set time and date using Setup. Exit and save to update the parameters.
Fixed disk failure	Press F2 to start Setup. Exit and save to update the parameters. If a problem still exists, check if the drive is installed properly.
Fixed disk controller failure	Press F2 . Start Setup. Exit and save to update the parameters. The hard disk controller is inoperable and requires repair.
Keyboard clock line failure	The keyboard requires repair.
Keyboard data line failure	The keyboard requires repair.
Keyboard controller failure	The keyboard requires repair.
Keyboard stuck key failure	A key is jammed. Remove any objects interfering with data entry. If the message remains, the keyboard requires repair.

NOTE: If a display related error occurs it is indicated by beeps. Display related errors usually require a system board replacement.

SETUP UTILITY

The Setup utility is a ROM-based program. It is functional when enabled (factory default). Setup automatically detects current system parameters during the power-on self-test (POST), described in the previous section. It also provides the following functions:

- sets date and time
- signals any hardware discrepancies during POST via error messages
- verifies that any optional memory that you installed was installed correctly
- integrates security features.

Setup also includes security features that protect your system from unauthorized use.

Accessing Setup

To access Setup, press **F2** at the power-on prompt

With an Error at POST

You will need to use the Setup utility if the system detects an error during POST, it prompts you with double beep sound and a message: "Press <F2> to resume, <F2> for Setup". If you press F2, POST continues. If you want to fix the error, carefully read the error message that appears above the prompt, and press **F2**.

After you press **F2**, the system displays the Setup Main menu.

With No Errors at POST

To enter Setup when no error message is displayed during POST, press **F2** when the prompt appears.

After you press **F2**, the system displays the Setup Main screen. The main screen displays the current hardware parameters of your computer.

Setup Screen

The Setup screens have four main areas of information. These include:

- Top Line of the Screen — contains user-selectable menu options.
- Left Half of the Screen — provides current parameter information. Selecting a parameter from the list (using the menu bar) toggles through selectable parameter settings.
- Right Half of the Screen — describes each parameter and the available settings.
- Bottom Line of the Screen — displays the keys that you can use to move the cursor or to select a particular function, such as saving parameters and exiting the menu.

Setup Keys

Refer to Table Section 2-5 for a description of Setup Key functions.

Table Section 2-5 Setup Key Functions

Key	Function
Tab	Moves cursor to another field in the menu. For example, pressing Tab moves the cursor up or down a list of current parameters.
Up or down arrow	Selects fields in the current menu.
Pg Up/Pg Down	Moves to previous/next page on scrollable menus.
-	Selects lower/higher value.
F9	Loads factory-installed Setup default values.
F10	Restores previous values from CMOS.
Esc	Opens Exit screen
Enter	Selects the parameter sub menu.

CHANGING/SETTING PARAMETER SETTINGS

Use the following steps to set or change parameter settings:

NOTE: Selecting incorrect values may cause a system boot failure. Load Setup default values to recover.

1. Select a parameter menu from the menu bar by moving the cursor to the word that represents the screen you want to display.

For example, to select "Peripherals," press the arrow key until the word Peripherals is highlighted. A screen appears with the current setting for each peripheral device.

2. View the parameter settings by pressing the space bar or the **+** key. The choices appear, toggling from one to another as you press.
3. When you reach the setting you want, leave it and move to the next parameter to be changed.
4. When you are through viewing or changing parameters, press **ESC** to move to the Exit screen.
5. The Exit screen displays a list of options. Press **Enter** to select "Save Changes and Exit". The screen displays a prompt confirming that the changes were made.
6. Press **Continue**. The system reboots with the saved changes.

PARAMETER OPTIONS

Refer to Table Section 2-6 for a complete list of the parameters selectable through Setup. It also lists factory default settings in the mobile mode. Parameter descriptions follow the table. Menu selections for Setup are the same except where noted.

Table Section 2-6 System Parameter Settings

Default Configuration	Default Values	Options
Main		
System Time	HR:MIN:SEC	
System Date	MO/DAY/YEAR	
Diskette Drive A	1.44MB, 3.5"	1.2MB, 5.25"/Not Installed
Diskette Drive B	Not Installed	1.44MB, 3.5"/1.2MB, 5.25"
Internal Hard Drives	Enable	Disable
Master	Auto	BIOS Defined/None/CD/User
Slave	None	BIOS Defined/Auto/CD/User
Docking Station Hard Drives:	Disable	Enable
Master	None	BIOS Defined/CD/User/Auto
Slave	None	BIOS Defined/CD/User/Auto
Boot Docking Station IDE	No	Yes
System Memory	640K	
Extended Memory	7168KB	11264KB (w/ 4MB card) 15360KB (w/ 8MB card) 23552KB (w/ 16MB card) 39936KB (w/ 32MB card) 12MB Memory card not supported
Peripherals		
Serial Port	Enabled	Disabled/Reconfigurable
Infrared Location	Rear	Front/Disable
Infrared Serial Port	COM2	Reconfigurable
Parallel Port	LPT1	LPT2/Reconfigurable/Disabled
Parallel Mode	Unidirectional	Bi-Directional/Enhanced
NumLock	Off	On
Keyboard auto-repeat rate	30/sec	2/6/10/13/19/22/27
Keyboard auto-repeat delay	½ sec	¼, ¾, 1 sec
Security		
User Password	Disabled	
Set Password	Press Enter	Enabled
Password on boot	Disabled	Enabled
Password on resume	Disabled	Enabled
Power Savings		
Power Management under AC	Off	On
Power Savings	Custom Settings	Highest Performance/Longest Battery Life/Off
Hard Disk Timeout	15 sec	Off, 15min/10/8/6/4/2/1/ 45sec/30/10
Panel Backlight	Auto	Full/Standard
Video Timeout	2 minutes	4/6/8/10/15min/Off,/10/15/30/45sec
Serial Timeout	On	Off
Parallel Timeout	On	Off
CPU Power Save	Off	On
Standby Timeout	2 minutes	1/4/6/8/12/16 min/Off

Table Section 2-6 System Parameter Settings

Default Configuration	Default Values	Options
Suspend Mode	Suspend	Save To File
Auto Suspend Timeout	15 minutes	60/40/30/20/10/5/Off min
Auto Save to File	On	Off
Suspend Warning Tone	On	Off
PCMCIA Power	On	Off
Sound Power	On	Off
Serial Port Ring Resume	Off	On
Wake up from Resume at:	0:00:00	

Parameter Descriptions

Read the following for an understanding of each parameter's function.

Time/Date

Use this option to set the time and date. The settings remain in memory even after you turn off system power.

To set the time, enter the current hour, minute, and second in hh:mm:ss, 24-hour format. Use the Tab key to move from field to field. For example, type 13:30:00, tabbing from field to field for 1:30 p.m.

To set the date, enter the current day, month, and year in mm/dd/yyyy format.

NOTE: When setting the time and date, enter preceding zeroes. For example, to enter 9:20 a.m. and February 4, 1996, type **09:20:00** and **02/04/1996**.

Drives

The Drives option lets you check or change parameters for your diskette drives, hard disk, and docking station hard drives.

One drive option you may have to change is Boot Docking Station IDE. When set to Yes, it will boot the operating system from the optional Docking Station 4000 hard drive. Otherwise, the system will boot from either the internal IDE hard drive or the CD-ROM if one is installed in VersaBay II.

Peripherals

The Peripherals screen displays the location of the connection between the system and the Input/Output (I/O) ports.

Security

The Security screen lets you set a password to protect your data by allowing your system to boot only after you enter a password.

When a system password is set, you must enter the password before you can enter Setup. This feature allows only an authorized user to change system parameters.

You are not prompted to enter a password until you set an initial password. Your system is not protected until you enter the initial password.

See "Security Options" later in this section for instructions on setting and using the system password.

Power Savings

The Power Savings screen lets you select the level of power management, suspend mode, and suspend/resume options.

- **Power Management Under AC** — Normally, whenever AC power is connected to the NEC Versa 4000, power management is disabled. If you enable this option, the system uses the power management mode (on or off) you set using the Power Management option.
- **Power Savings** — A "Highest Performance" setting provides the greatest system performance. "Longest Battery Life" provides maximum power saving, and "Off" disables all power management timers. You can also customize the system's power management by selecting "Custom Settings" and entering values for system timeouts.
- **Suspend Mode** — Suspend mode has a method of operation called Suspend/Resume that stores information in RAM and maintains RAM contents after shutting down all local devices. You also have the option to select Save to File. This saves all your open data files to a special file on the hard disk whenever the system goes into Suspend mode. All your data is automatically recovered from where you left off when you Resume.
- **Suspend Warning Tone** — This option lets you enable or disable a warning tone when Suspend mode starts. It is best to keep this option enabled.
- **PCMCIA Power** — This option allows you to turn off power to the PCMCIA slots in order to save system power. The slot's power cannot be turned off if a card is installed in the slot.

SECURITY OPTIONS

The system supports two types of passwords for system security:

- system password
- keyboard lock hotkey.

The following contains instructions for setting and using the password feature.

System Password

Use the system password to lock the system at power-on. The system password is set using Setup. This locks the keyboard to prevent unauthorized access to the system. When a system password is set, the password must be entered before entering Auto Setup. This feature allows only authorized access to system parameters.

See the following procedures to set an initial password.

1. Select the Security option in Setup.
2. Select "Set Password" by pressing Enter.
3. At the prompt, enter a password up to seven characters long. Another window appears with a prompt to reenter your password for verification. Write your password down and keep it in a secure place in case you forget it.
4. Press **Enter** to return to the Security screen.
5. Press **ESC** to save the changes and exit Setup.

Once you have set the password, you can select Enable on Boot. This means that each time you start up (boot) your NEC Versa, you'll be prompted for a password.

Using the System Password

After setting the initial password, a password prompt appears each time the system is powered on. At the password prompt, enter your password and press **Enter** to load your operating system or to enter Setup. The characters entered do not appear on the screen.

NOTE: If a system password is set, you can't enter Setup until you enter the password.

If it takes more than three tries to enter the correct password, power off the system and try again. Repeat steps 1 and 2 above.

To remove a password, at the password prompt press **Enter**. Press **Enter** again when the re-enter prompt appears. Your password clears and you are no longer prompted to enter one when you power on the system.

Keyboard Lock Hotkey

The system supports a keyboard lock feature for additional security. The lock option appears on the Setup screen only after you have enabled a password. At this point in Setup, the lock can be enabled or disabled.

To lock the keyboard, press **Ctrl + Alt + Back Space**. To unlock the keyboard, enter the password. If the password is removed, this option is no longer available.

BIOS UPDATE UTILITY (BUU)

The BIOS Update utility updates the ROM BIOS version of the system. This software utility updates the Flash ROM installed on the system board. The utility identifies and saves the currently installed BIOS version before installing the new version.

To receive the latest BUU diskette (in the U.S. only), call the Technical Support Center at (800) 632-4525 or download the BUU by logging onto NEC's Electronic Bulletin Board System (BBS) and perform the procedures described in the following subsections.

To use the BIOS Update utility, the system configuration must be set to 640 KB of base memory with the programming voltage enabled.

Precautions

The BIOS Update utility diskette saves the old BIOS version. Make sure the diskette is not write-protected. If attempting to use a diskette that has updated another unit, a message warns that the original BIOS may not be restored. If updating more than one system, first make a copy of the original diskette for each system before using the diskette.

Downloading the Update Utility

To receive the latest version of the BIOS Update utility, perform the following steps.

1. Log onto NEC's BBS by dialing (508)-635-4706. The BBS parameters are as follows.
 - Baud rate: 300 to 14,400 Kbps
 - Parity: none
 - Data bits: 8
 - Stop bits: 1
 2. Once connected, a name and password must be entered. When connecting for the first time, a questionnaire must be completed.
 3. At the NEC/Technologies Bulletin Board main menu, type **F** and then press **Enter** for the File Menu.
-

4. At the File Menu, type **D** and then press **Enter** for download.
5. Type the file name, **L440nB3.EXE**, and press **Enter**. Insert the correct revision number in place of the *n*.
6. Press **Enter** again.
7. Set the default protocol on the BBS.
8. The BBS displays a prompt that it is ready to send the file. Perform the software's download transfer procedure. The files are sent to the hard drive. Execute the file to create a bootable disk. A message prompts you to insert a 1.44-MB diskette drive in drive A. Make sure that it is a high-density diskette. Press any key to continue.

After pressing any key, the diskette is formatted and the BIOS update files are copied to the diskette.
9. After the download is completed, log off the BBS.

NOTE: If you don't know the filename, join the laptop conference to find the BIOS or driver disk you need.

Using the Update Utility

Load the BIOS Update utility as follows.

CAUTION: Never load a BUU from another system model. That system's BIOS will be lost.

1. Power off the system unit.
2. Make sure Switch 1 on the dip switch is off.
3. Insert the BIOS Update Utility diskette into drive A.
4. Power on the system unit. The unit boots and automatically loads the utility. A message similar to the following appears:

FLASH ROM EQUIPPED

WARNING: The BIOS Update Procedure
is about to begin, press ENTER to continue.
To abort, remove the diskette and reset the unit.

5. Press **Enter** to continue. The utility checks the currently installed BIOS version and the diskette's BIOS versions. If the BIOS can be updated, the Main Menu appears (see the following screen). If there is a problem, the appropriate message is displayed.

NOTE: The Customize BIOS option shown in the following menu is no longer available.

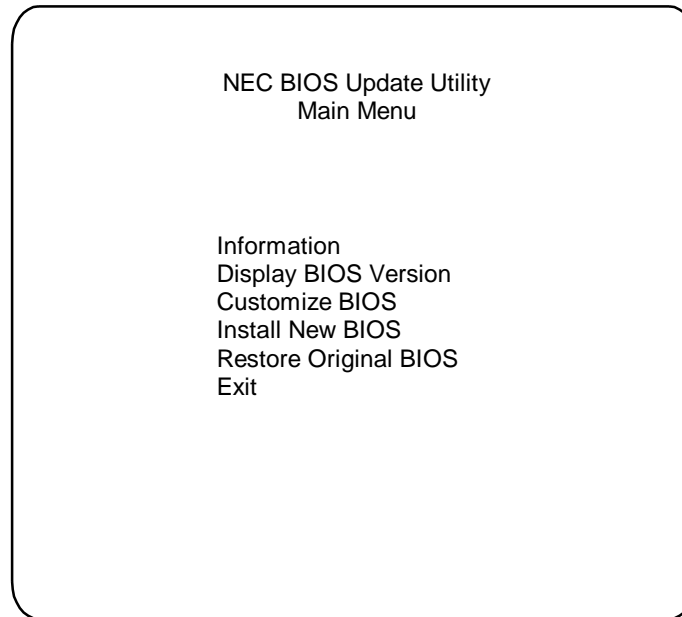

Menu Functions

Use the Main Menu to update the BIOS version; other menu functions are optional. To select a menu function, use the arrow keys to highlight the function and press **Enter**. If help is needed, press **F2** for additional information.

Information

This option provides important information about the BIOS Update utility. Read this information before proceeding with the utility.

Display BIOS Version

Use this option to display the currently installed BIOS version and the version of the new replacement BIOS. A message similar to the following appears.

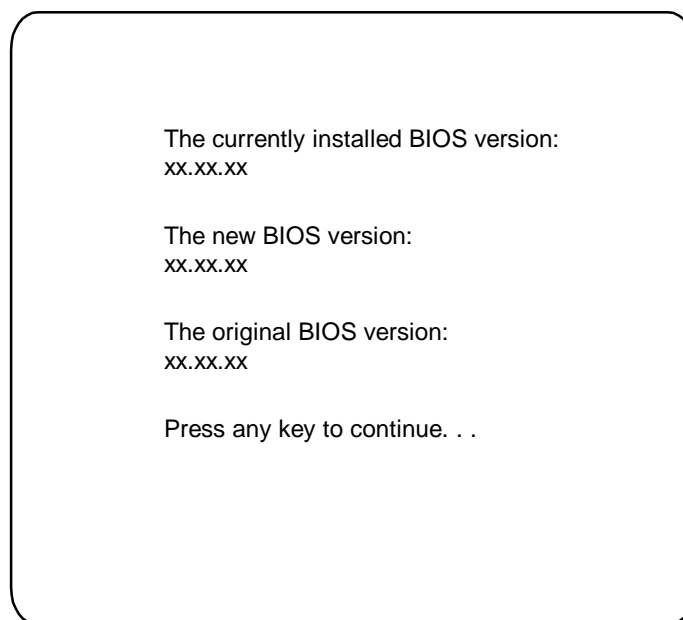

NOTE: The original BIOS version level is included if the utility was run previously.

Install New BIOS

This menu option first saves the system's original BIOS to the diskette and then installs the new BIOS. Be sure to choose the Customize BIOS feature, if desired, before selecting this option. This procedure may require 10 to 60 seconds. A continuous sound pattern means a failure.

When selecting the Install New BIOS function, a message similar to the following appears.

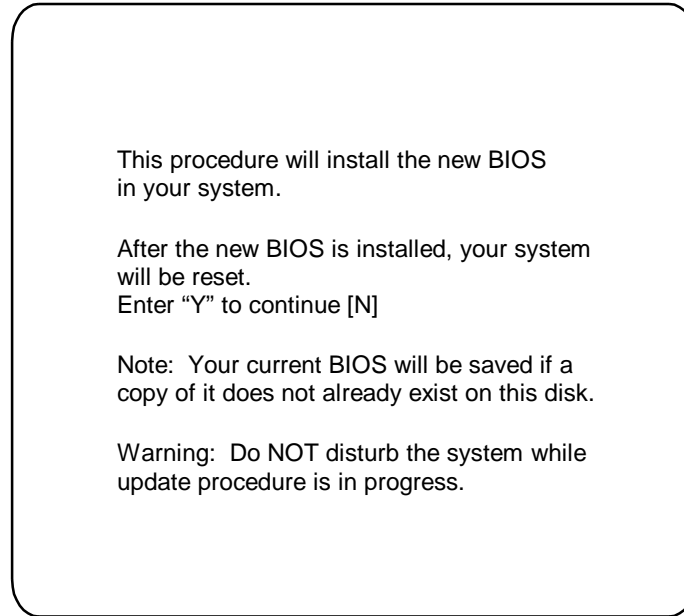

The utility updates the BIOS and resets the system to make the new version operational. To reuse the utility, power the system off and back on again with the BIOS Update Utility diskette inserted in drive A.

Restore Original BIOS

Use this option to restore the previous BIOS from the update diskette. If the system BIOS was not updated, this function does nothing. A message indicates the new BIOS must be installed before the original BIOS can be restored.

This procedure installs the previously saved BIOS in the system. Selecting this function displays a message similar to the following.

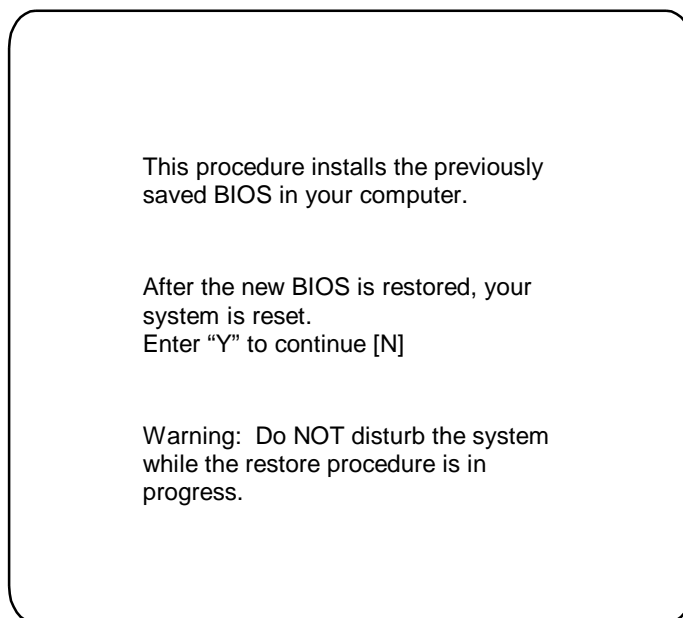

This procedure may require 10 to 60 seconds. A continuous sound pattern means a failure. The utility restores the previous BIOS and resets the system to make the previous version operational. To reuse the utility, power the system off and back on again with the BIOS Update Utility diskette inserted in drive A.

Exit

This option exits the utility and resets the system. Press **Esc** to return to the Main Menu. Press **Enter** to exit the utility.

POWER SOURCES

For optimum performance and power conservation, use the AC adapter to power the NEC Versa 4000 series system. Other power sources include the battery pack, the optional car DC adapter and the optional docking station .

AC Adapter

The AC adapter allows the system to operate with AC power, recharges the battery pack, and maintains the bridge battery. The internal backup battery allows the system to retain system parameter information.

NOTE: Make sure that the AC adapter is connected at all times. It will continue to charge the battery pack and bridge battery during operation or when the system is turned off.

If the AC adapter is used primarily, remove the battery pack to reduce system weight.

CAUTION: Only use the AC adapter model provided with the NEC Versa 4000 series system.

Connect the AC adapter as follows:

1. Connect the adapter's DC cable to the power connector on the rear of the system. Connect the other end to the AC adapter.



Figure Section 2-8 Connecting the AC Adapter

2. Connect one end of the AC power cable to the AC adapter. Connect the other end of the AC power cable to a 100- to 240-volt, AC wall outlet.

Battery Power

A fully charged battery pack lasts approximately up to 5 hours with Power Management, or 2.5 hours without Power Management.

When battery power is low, the battery outline on the battery status LCD blinks. If the system speaker is enabled, three low battery warning beeps are emitted. The actual amount of battery time depends on the use of power-saving features, the application, options installed, and the environment.

Refer to “Battery Status” in the “Operating Controls” section for information on determining how much battery power is currently available.

When battery power is low, put your system in Suspend mode, remove the battery pack, and replace it with a fully charged Li-Ion battery. Or, recharge the battery pack as follows.

Recharging the Battery Pack

To recharge the battery, leave the battery in the system and connect your NEC Versa to the AC adapter and wall outlet. If you connect the system to the AC power and continue to use it, the battery recharges in 2.5 to 7 hours. If you do not use the system while it is recharging it takes about 2.5 hours.

REPLACING THE BATTERY PACK

To replace the battery pack with a fully charged battery, press the suspend button to activate Suspend mode. It is not necessary to turn off system power as long as Suspend mode is activated. The bridge battery maintains data and system status for up to 5 minutes while in Suspend mode. Use the steps below to install a charged battery pack.

1. If power is on, push the suspend button to put the system in Suspend mode. The bridge battery saves the memory contents and system status.
2. Turn the NEC Versa 4000 over so that it is upside down with the front of the system facing you.
3. Remove the battery cover as follows:
 - Locate the battery cover latch and slide it towards the front of the system
 - Slide the cover about half an inch away from the system to align the cover tabs and notches.

- Lift the cover up and away from the system.

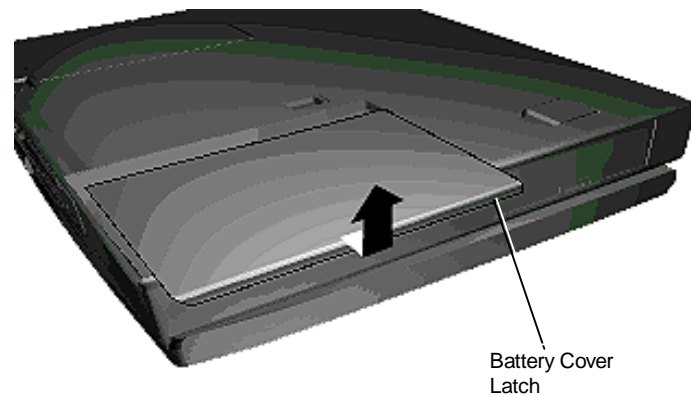

Figure Section 2-9 Battery Cover Latch Location

4. Insert the new battery as follows:

- Align the battery terminals with the terminals in the system.
- Lower the terminal end of the battery pack into the bay,
- Next, lower the notched end into the bay.

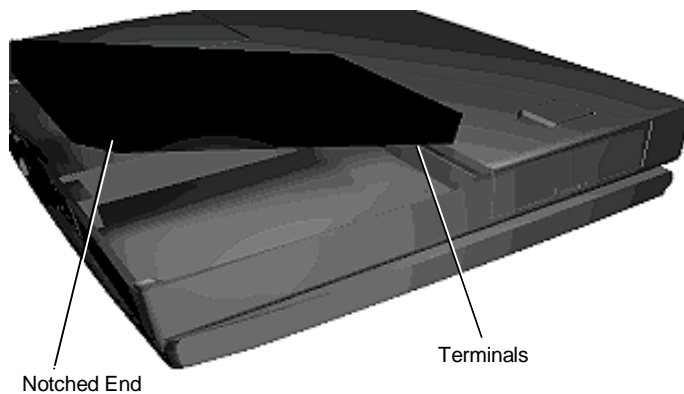

Figure Section 2-10 Battery Pack Replacement

5. Replace the battery bay cover as follows:

- Align the tabs on the battery cover with the notches in the system.
- Lower the cover onto the system.
- Slide the cover towards the middle of the unit. Tuck the tabs on the back of the cover under the chassis.



Figure Section 2-11 Battery Bay Cover Replacement

Saving Battery Power

The system utilizes two power conserving states: Active and Suspend mode. The system automatically switches between these modes to conserve battery power and prolong battery life. To save additional power, use the following guidelines:

- put the system in Suspend mode when you need to leave the system for a short time
- reduce the LCD's brightness using the Fn F5 hot key to toggle the LCD backlight between standard or full
- turn off the system when not in use.

The system also integrates automatic power-saving features. Refer to Table Section 2-7 for a complete description.

AUTOMATIC POWER-SAVING FEATURES

Table Section 2-7 lists the NEC Versa 4000 series automatic power conserving features. These features work during battery and AC operation. The features listed below do not work when the optional docking station is connected.

The default timeouts listed below can be changed using Setup.

Use the **Fn F7** key combination to set the power management level. You can toggle between Highest Performance, Longest Battery Life, Custom Values, and Off. You can modify the custom level for your specific working environment using Custom Values. Default values change depending on the type of power management you use.

Table Section 2-7 Automatic Power-Saving Features

Device	Default (timeout)	Description
LCD backlight	2 min.	When no keyboard or NEC VersaGlide input occurs for the specified timeout, the LCD backlight shuts off.
Hard Disk	10 sec.	Hard disk motor stops when not accessed for specified timeout.
Suspend Mode	5 min.	The system enters Suspend mode after total system activity.

Section 3

Illustrated Parts Breakdown

This subsection contains the illustrated parts breakdown (IPB) and NEC part numbers for the NEC Versa 4000 series system. Table Section 3-1 lists field-replaceable parts and corresponding part numbers. Table Section 3-2 lists option and documentation part numbers.

NOTE: In the U.S., call 1(800) 632-4525 to order NEC spare parts. To order options in the U.S., call your local sales office.

Table Section 3-1 NEC Versa 4000 Series Field-Replaceable Parts*

Item	Description	Part Number
1	Battery Cover	136-237721-001A
2	PCMCIA Cover	136-237720-001A
3	Bottom Base Assembly	136-237714-011A
4	Expansion Port Cover	136-237719-001A
5	I/O Port Cover	136-237718-001A
6	I/O Board	Refer to online IPB
7	Battery Charger Board	808-891789-001A
8	Sound Board (G8UNA)	158-026201-000C
9a	75 MHz CPU Board (G8TUN)	Refer to online IPB
9b	90 MHz CPU Board (G8TUNA)	Refer to online IPB
9c	120 MHz CPU Board	Refer to online IPB
11	Keyboard (U.S.)	808-897250-001A
12	Infrared Rear Assembly (G8UAQ)	136-531163-A
13	Microphone/LED Board (G8UAR)	136-531164-A
14	NEC VersaGlide	808-874649-002A

3-2 Illustrated Parts Breakdown

Table Section 3-1 NEC Versa 4000 Series Field-Replaceable Parts*

Item	Description	Part Number
15	LCD Indicator	808-872191-003A
16a	LCD Base Assembly, includes speakers (C-SVGA)	TBD
16b	LCD Base Assembly, includes speakers (C-TFT)	136-237705-001A
16c	LCD Base Assembly, includes speakers (C-DSTN)	136-237706-001A
17	NEC Logo	136-600325-A
18	LCD Lock Spring	136-604300-A
19	LCD Lock Shaft	136-617799-A
20	LCD Lock	136-617798-001A
21a	LCD Cover (SVGA)	136-617796-001A
21b	LCD Cover (TFT)	136-237711-001A
21c	LCD Cover (DSTN)	136-237712-001A
22	Intel Inside Sticker	158-030412-001A
23a	NEC Versa 4000 Logo (SVGA)	158-030781-002
23b	NEC Versa 4000 Logo (TFT)	158-030781-001
23c	NEC Versa 4000 Logo (DSTN)	158-030781-000
24	Top Cover Assembly	136-237713-011A
25	AC Adapter	808-891790-001A
26	AC Power Cord (U.S.)	808-741299-001A
27	CMOS Battery	804-021107-003A
28	Infrared Front Assembly (G8UAP)	136-531162-A
29	Speaker	802-870018-006A
30	Bridge Battery	804-021205-001A
31a	360-MB Hard Disk Drive	136-237726-001A
31b	540-MB Hard Disk Drive	136-237726-002A
31c	720-MB Hard Disk Drive	136-237726-003A
32	Hard Disk Drive Cover	136-237722-001A
33	3 1/2-inch Diskette Drive	136-237724-001A
34	Main Battery (Lithium Ion)	804-021204-001A
35*	Knob Volume	136-607428-001A
36*	Rubber Foot	808-814221-039A
37*	CD-ROM Drive	136-267770-001A

* Not shown in IPB figure

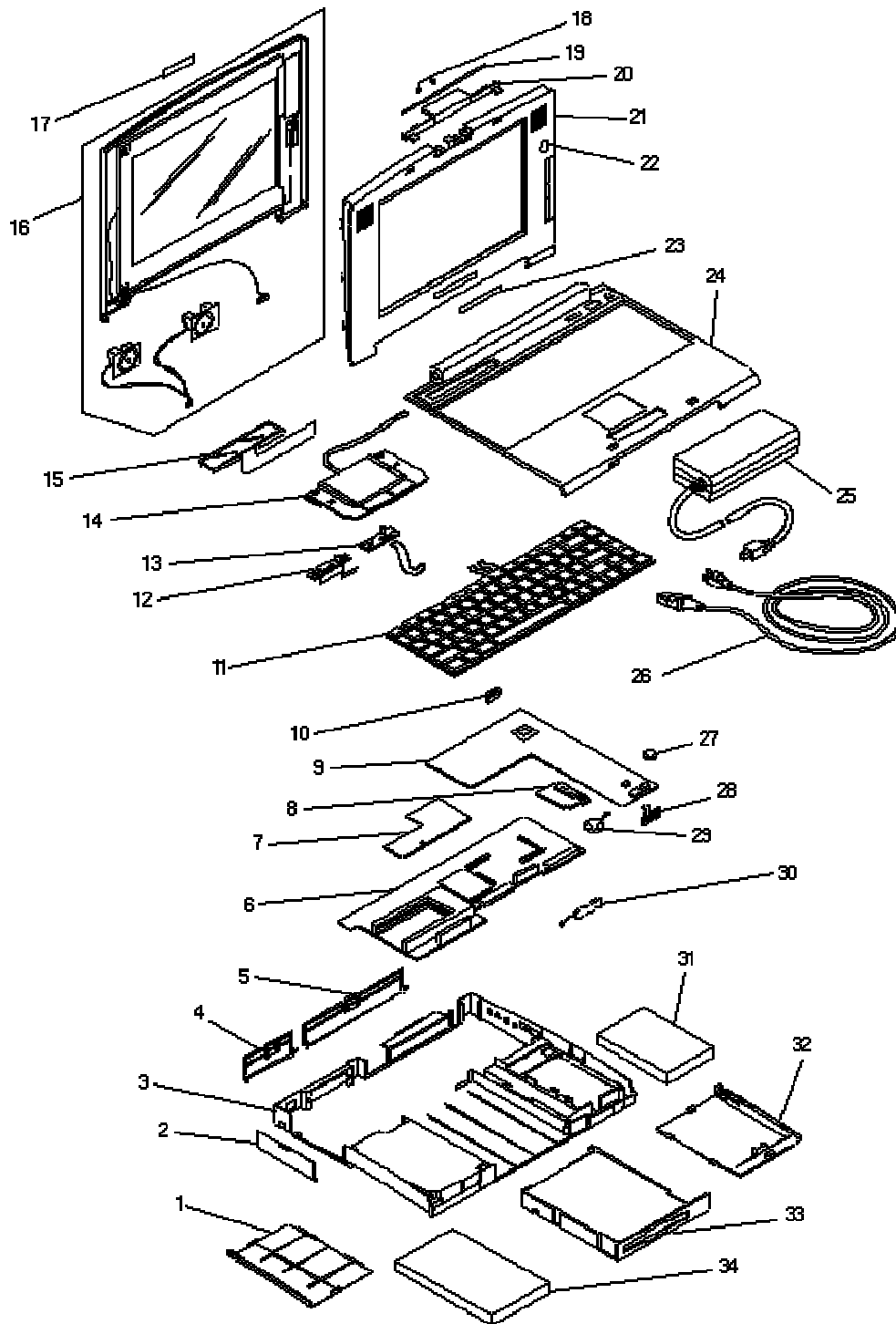

Figure Section 3-1 NEC Versa 4000 Series Illustrated Parts Breakdown*

* This data was prepared January 1998. For an up-to-date listing of spare parts, please call FaxFlash (888) 329-0088 and order document number 42200013.

3-4 Illustrated Parts Breakdown

Table Section 3-2 Option and Documentation Part Numbers *

Description	Model Number
540 MB Hard Disk Drive	OP-220-60001
720-MB Hard Disk Drive	OP-220-60002
810-MB Hard Disk Drive	OP-220-60004
Hard Disk Drive Adapter Kit	OP-540-61001
4 MB Memory Card	OP-410-4001
8 MB Memory Card	OP-410-4002
16 MB Memory Card	OP-410-4003
32 MB Memory Card	OP-410-4004
Li-ION Battery Pack	OP-570-61001
AC Adapter	OP-520-61001
Li-ION Battery Pack	OP-570-61001
Battery Charger	OP-570-61002
Port Replicator	OP-560-61001
CD ROM Reader	OP-260-61001
28.8 kbps Data/Fax Modem	OP-710-4011
14.4Kbps Data/Fax Modem (PCMCIA)	OP-710-4009
NEC VersaPage PC-Card Pager	OP-710-4411
High Performance Ethernet Card	OP-720-1201
NEC VersaVideo Portable Digital Video Card	OP-750-4701-1
500 Kbps SCSI Card	OP-740-4001
NEC Versa 4000 Series Quick Setup Sheet	819-181301-000
NEC Versa 4000 Series User's Guide	819-181300-000
NEC Versa 4000 Series Service and Reference Guide	819-200013-000
PS/2 Y Adapter	OP-510-1201

* This data was prepared January 1998. For an up-to-date listing of spare parts, please call FaxFlash (888) 329-0088 and order document number 42200013.

Appendix A

Connector Locations and Pin Assignments

Table Appendix A-1 lists connector descriptions. The remaining tables provide pin assignments for system connectors.

Table Appendix A-1 CPU Board Connectors

Connector	Description
P4	LCD Indicator Panel
P2 and P3	Keyboard Connectors
P11	Rear Infrared Assembly
P5	VersaGlide
P12	CMOS Battery
P8	Bridge Battery
P9	Speaker
P10	Front Infrared Assembly

Table Appendix A-2 Keyboard/Mouse Connector Pin Assignments

Pin	Signal
1	KeyboardData
2	MouseData
3	Ground
4	+5V
5	Keyboard Clock
6	Mouse Clock

Table Appendix A-3 Serial Port Connector Pin Assignments

Pin	Signal
1	Data Carrier
2	Receive Data
3	Transmit Data
4	Data Terminal Ready
5	Ground
6	Data Set Ready
7	Request to Send
8	Clear to Send
9	Ring Indicator

Table Appendix A-4 CRT Connector Pin Assignments

Pin	Signal
1	Red
2	Green
3	Blue
4	No Connection
5	Ground
6	Ground
7	Ground
8	Ground
9	+5V PnP VESA Vcc
10	Ground
11	No Connection
12	PnP VESA Data
13	Horizontal Sync
14	Vertical Sync
15	PnP VESA Clock

Table Appendix A-5 Parallel Printer Pin Assignments

Pin	Signal
1	- Strobe
2	Data Bit 0
3	Data Bit 1
4	Data Bit 2
5	Data Bit 3
6	Data Bit 4
7	Data Bit 5
8	Data Bit 6
9	Data Bit 7
10	- Acknowledge
11	Busy
12	PE
13	Select
14	- Auto Feed XT
15	- Error
16	- Initialize
17	- Select In
18 -25	Ground

Table Appendix A-6 Expansion Connector Pin Assignments

Pin	Signal
1	+5V
2	+5V
3	DSDET2
4-23	Ground
24	DSDET2
25-32	+12V CHG
33	Docking Station Detect
34	AGND
35	AGND
36	AGND
37	TC
38	BALE
39	IOCHCK
40	IOCHRDY
41	AEN
42	SBHE
43	MEMR
44	MEMW
45	RESET DRV
46	OWS
47	SMEMR
48	SMEMR
49	IOR
50	IOW
51	IOCS16
52	PC Detect
53	HDD Access
54	FDD Access
55	Mouse Clock
56	Mouse Data
57	Keyboard Clock

Table Appendix A-6 Expansion Connector Pin Assignments

Pin	Signal
58	Keyboard Data
59	Reserved
60	+12V Sys
61	Floppy Track 0
62	Through
66	+12V Sys
67	CRT Red
68	CRT Green
69	SA17
70	SA18
71	SA19
72	MENCS16
73	Refresh
74	Printer-Strobe
75	Printer-Acknowlg
76	Printer-Busy
77	Printer-P End
78	Printer Select
79	Printer-Auto FD
80	Printer -Error
81	Printer-Initialize
82	Printer Select In
83	FD Head Select
84	FD-Direction In
85	FD-Boot Select
86	FD-Low Density
87	FD-Write Enable
88	FD-Step
89	LA23
90	LA22

Table Appendix A-6 Expansion Connector Pin Assignments

Pin	Signal
91	LA21
92	LA20
93	LA19
94	LA18
95	LA17
96	FD-Write Protect
97	FD-Disk Change
98	FD-Read Data
99	FD-Index
100	CRT-Blue
101	CRT-HSync
102	SD8
103	SD9
104	SD10
105	SD11
106	SD12
107	SD13
108	SD14
109	SD15
110	Master
111	Serial-CD
112	Serial-TXD
113	Serial-RXD
114	Serial-DTR
115	Serial-DSR
116	Serial-RTS
117	Serial-CTS
118	Serial-RI
119	FD-Drive Select
120	FD-Motor 0
121	SD7

Table Appendix A-6 Expansion Connector Pin Assignments

Pin	Signal
122	SD6
123	SD5
124	SD4
125	SD3
126	SD2
127	SD1
128	SD0
129-132	Reserved
133	CRT-VSync
134	CLK1
135	PR-D2
136	PR-D4
137	PR-D6
138	IRQ3
139	IRQ5
140	IRQ7
141	IRQ10
142	IRQ12
143	IRQ15
144	DRQ1
145	DRQ3
146	DRQ6
147	DACK0
148	DACK2
149	DACK5
150	DACK7
151	FD-Drive Select 1
152	FD-Motor 1
153	FD-Write Data
154	SA15
155	SA13
156	SA11

Table Appendix A-6 Expansion Connector Pin Assignments

Pin	Signal
157	SA9
158	SA7
159	SA5
160	SA3
161	SA1
162	Audio Analog Ground
163	Audio Analog Ground
164	Line-in Right
165	Line-in Left
166	PR-D0
167	PR-D1
168	PR-D3
169	PR-D5
170	PR-D7
171	IRQ4
172	IRQ6
173	IRQ9
174	IRQ11
175	IRQ14

Table Appendix A-7 Power Connector

Pin	Signal
1	Not Defined
2	+19V
3	Ground

Table Appendix A-8 Hard Disk Drive Connector

Pin	Signal
1	HDD Access LED
2	+5V
3	Chip Select 0
4	+5
5	Chip Select 1
6	+5V
7	Address 0
8	+5V
9	Addrss 2
10	+5V
11	Address 1
12	+5V
13	Diagnostic
14	Not Used
15	IRQ
16	Not Used
17	IO16I
18	IO Channel Ready
19	Cable Select
20	IO Write
21	I/O Read
22	Not Used
23	Data 0
24	Data 1
25	Data 15

Table Appendix A-9 Diskette Drive Connector

Pin	Signal
1	SIDE
2	FDCNT
3	RDATA
4	No Connection
5	WPRT
6	Ground
7	Ground
8	No Connection
9	TRK0
10	Ground
11	WE
12	No Connection
13	WDATA
14	Ground
15	Ground
16	No Connection
17	STEP
18	Ground
19	DIR
20	No Connection
21	No Connection
22	MOTOR
23	DSKCHG
24	No Connection
25	DRVSEL
26	VCC
27	VCC
28	No Connection
29	INDEX
30	VCC

Index

A

AC adapter, 2-23
Accessing setup, 2-10
Active mode, 1-17
Automatic power saving, 2-27

B

Battery charging time, 2-24
Battery pack, 1-4
Battery power, 2-24
Battery status, 2-5
BIOS update, 1-14
Bridge battery, 1-4, 2-23
BUU menu functions, 2-20
BUU precautions, 2-17

C

Cable connections, 2-2
Cache controller, 1-13
Cache RAM, 1-5
Chip types, 1-12
CMOS battery, 1-4
Connecting the AC adapter, 2-23
CPU, 1-12
CPU board, 1-3
CRT connector pin assignments, A-2
CRT port, 1-3

D

Default power management settings, 1-18
Dip switch, 2-7
Dip switch settings, 2-7
Diskette connector assignments, A-10
Diskette controller, serial interface, parallel interface, 1-15
Diskette drive, 1-5
Downloading the BUU, 2-17
DSTN, 1-3

E

Expansion port pin assignments, A-8
External keyboard connector pin assignments, A-1

F

Flash ROM, 1-13, 2-17
Function keys, 2-6

H

Hard disk drive connector pin assignments, A-9
Hardware failures, 2-9
Hardware overview, 1-2
 VersaBay II, 1-5
High resolution TFT, 1-3

I

I/O board, 1-3
I/O connector descriptions, 2-2
Increasing system memory, 1-5
Infrared assembly, 1-4
Infrared port, 2-2
Interrupt level assignments, 1-16

K

Keyboard, 1-5
Keyboard controller, 1-15
Keyboard lock hot key, 2-17
Keyboard panel controls, 2-3

L

LCD
 LCD types, 1-2
LCD backlighting, 1-3
Local power management, 1-18

M

Memory
 cache RAM, 1-5
Memory map, 1-6
Microprocessor, 1-1, 1-12
Multimedia, 1-2

N

NEC Versa 4000 parts list, 3-1
NEC Versa 4000 system specifications, 1-19

O

Operating controls, 2-3
Option part numbers, 3-4

P

Parallel interface enhanced capabilities port, 1-11
Parallel port pin assignments, A-3
Parameter descriptions, 2-14
Parameter settings, 2-13
Parameters
 drives, 2-14
 peripherals, 2-14
 Power savings, 2-15
 security, 2-15
 time/date, 2-14
PCMCIA controller, 1-15
PCMCIA Slots, 1-5
Pentium, 1-1
Plug and play, 1-18
Post error messages, 2-9
Post errors, 2-9
Power connector pin assignments, A-8
Power management modes
 active, 1-17
 local standby, 1-17
 suspend, 1-17
Power management overview, 1-17
Power management settings
 default, 1-18
Power sources, 2-23
Power switch, 2-4
Power-on self test (POST), 2-8

R

Rear panel connectors, 1-2
Recharging the battery pack, 2-24
Replacing the battery pack, 2-24
ROM BIOS, 1-14

S

Saving battery power, 2-26
Security options, 2-16
Serial interface, 1-12
Serial port connector pin assignments, A-2
Setup keys, 2-11
Setup screen, 2-11
Setup utility, 2-10
Side panel controls, 2-3
Smart power switch, 2-6
Sound board, 1-3
Status bar, 2-4
Suspend mode, 1-17, 2-24
System board connectors, A-1
System configurations, 1-1
System features, 1-1
System icons, 2-5
System logic, 1-13
System memory, 1-5
System parameters, 2-8
System password, 2-16
System setup, 2-1
System status
 icons, 2-5
System video, 1-7

T

TFT, 1-3
Time/Date, 2-14

U

Unpacking, 2-1
Using the system password, 2-16
Using the update utility, 2-18

V

VersaBay II, 1-5

VersaGlide, 1-5

VGA controller, 1-14

Video controller architecture, 1-15

Video mode

640x480 DSTN, simultaneous CRT,
1-10

640x480 TFT, simultaneous CRT, 1-9
CRT only, 1-7

Video RAM, 1-7