

FIELD REPLACEABLE UNIT DOCUMENTATION

Satellite ProTM **6000 Series**

GENERAL INFORMATION

Tools Required for Proper Disassembly and Reassembly:

1. Phillips Screwdriver (Size 0&1)
2. Flat head Screwdriver
3. Security Torx (Size 7)
4. Case Separator
5. ESD Wrist Strap
6. ESD mats
7. Tweezers

Before attempting any of the following procedures, make sure that the main battery and AC adaptor is not connected to the unit and the environment in which you are working on is protected from Electro-Static Discharge(ESD).

TOSHIBA

Tough Enough for Today's World.

FIELD REPLACEABLE UNIT DOCUMENTATION

Satellite ProTM **6000 Series**

TABLE OF CONTENTS:

- 1. BATTERY PACK REMOVAL**
- 2. OPTIONAL PC CARD REMOVAL**
- 3. SELECT BAY REMOVAL**
- 4. CD-R/W/DVD-ROM DRIVE DISASSEMBLY**
- 5. MEMORY MODULE REMOVAL**
- 6. BLUETOOTH CARD REMOVAL**
- 7. MODEM BOARD REMOVAL**
- 8. HDD REMOVAL**
- 9. KEYBOARD REMOVAL**
- 10. WIRELESS LAN CARD REMOVAL**
- 11. TOP COVER REMOVAL**
- 12. COOLING MODULE REMOVAL**
- 13. CPU REMOVAL**
- 14. RTC BATTERY REMOVAL**
- 15. POWER SUPPLY BOARD REMOVAL**
- 16. SD/SOUND BOARD REMOVAL**
- 17. SYSTEM BOARD REMOVAL**
- 18. MEMBRANE SWITCH REMOVAL**
- 19. SPEAKERS REMOVAL**
- 20. 14.1" DISPLAY MASK REMOVAL**
- 21. FL INVERTER AND 14.1" LCD REMOVAL**

TOSHIBA

Tough Enough for Today's World.

FIELD REPLACEABLE UNIT DOCUMENTATION

Satellite Pro™ 6000 Series

BATTERY PACK REMOVAL

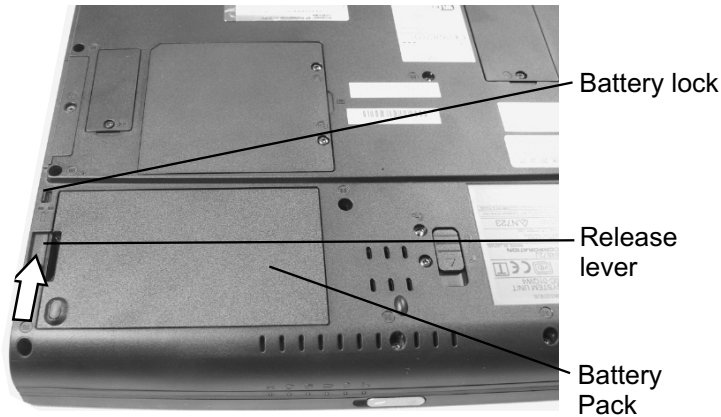

1. Turn the computer upside down as shown.
2. Slide the **battery lock** to unlock position.
3. Slide **battery release lever** in the direction of the arrow.
3. Lift out the **battery**.

OPTIONAL PC CARD REMOVAL

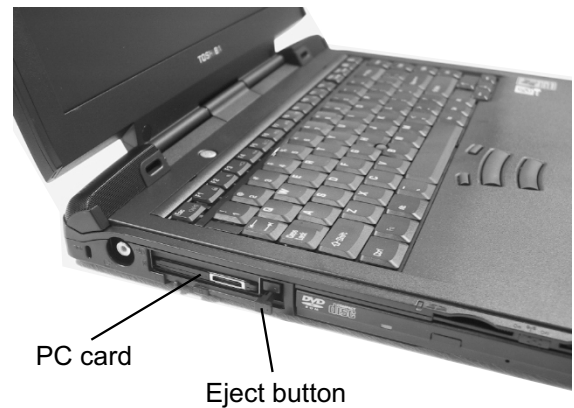

1. Press the **eject button** of the PCCard you want to remove.
 2. Press the extended eject button to pop the **PC card** out.
 3. Grasp the **PC card** and remove it.
- Note: Before removing any PC Card device, make sure it is "STOPPED" in the PC Card manager.

SELECT BAY REMOVAL

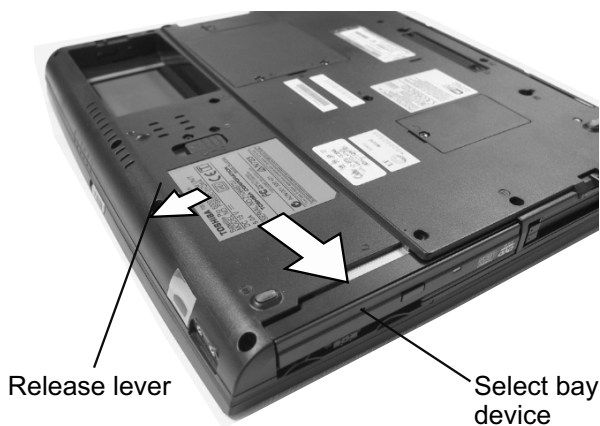

1. Turn the computer upside down.
2. Slide the **release lever** in the direction of the arrow.
3. Pull out the **select bay device** in the direction of the arrow.

CD-R/W/DVD-ROM DRIVE DISASSEMBLY

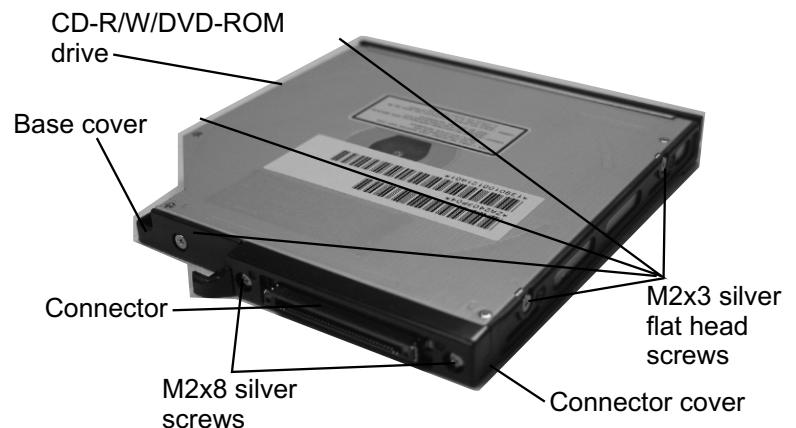

1. Remove **five M2x3 silver flat head screws** securing the base cover and lift out the **cover**.
2. Remove **two M2x8 silver screws** securing the connector cover.
3. Remove the **connector cover** and the **connector** from the CD-R/W/DVD-ROM drive.

TOSHIBA

Tough Enough for Today's World.

FIELD REPLACEABLE UNIT DOCUMENTATION

Satellite Pro™ 6000 Series

MEMORY MODULE REMOVAL

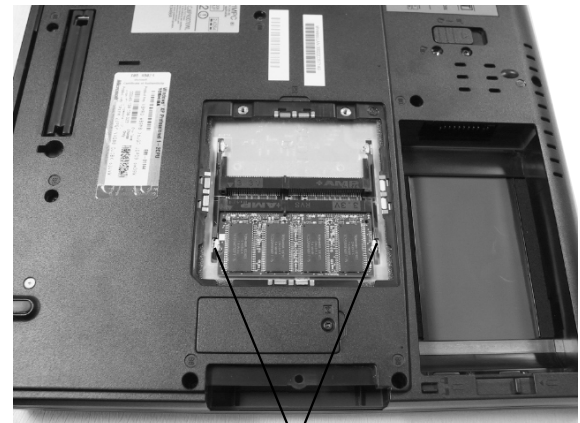
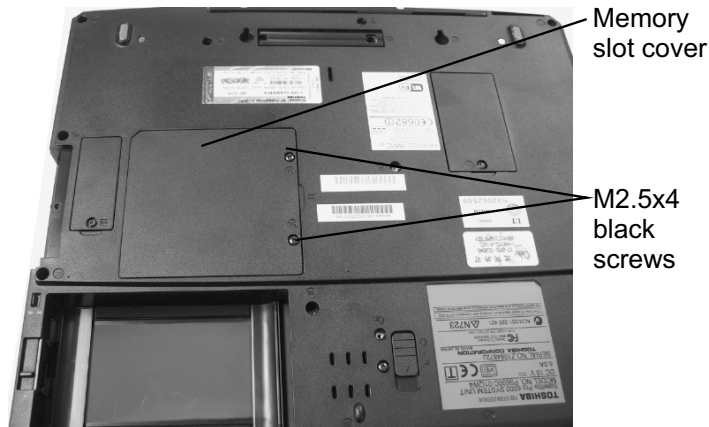

1. Turn the computer upside down.
2. Remove **two M2.5x4 black screws** securing the memory cover.
3. Lift out the **memory slot cover**.

4. Spread the **memory clips** outward and pull the **memory module** out of the connector on a 45 degree angle.

BLUETOOTH CARD REMOVAL

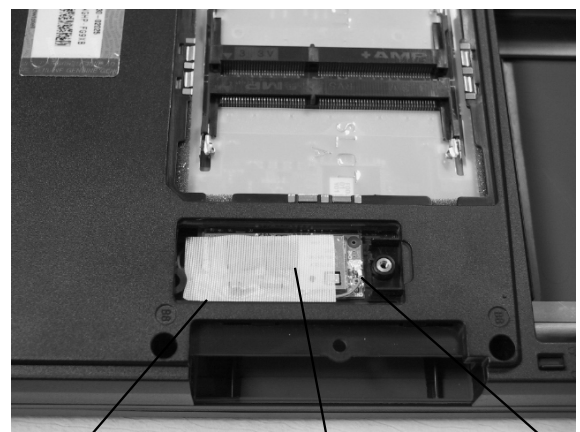
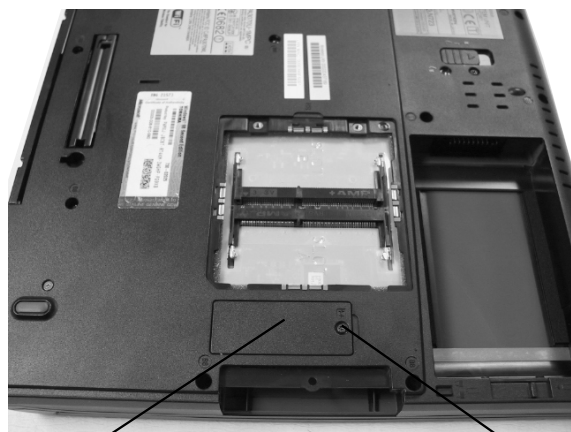

1. Remove **one M2x4 security torx screw** securing the bluetooth cover.
2. Lift out the **bluetooth cover**.

3. Disconnect the **coaxial cable** from the bluetooth card.
4. Disconnect the **bluetooth card** from the system board.

TOSHIBA

Tough Enough for Today's World.

FIELD REPLACEABLE UNIT DOCUMENTATION

Satellite Pro™ 6000 Series

MODEM BOARD REMOVAL

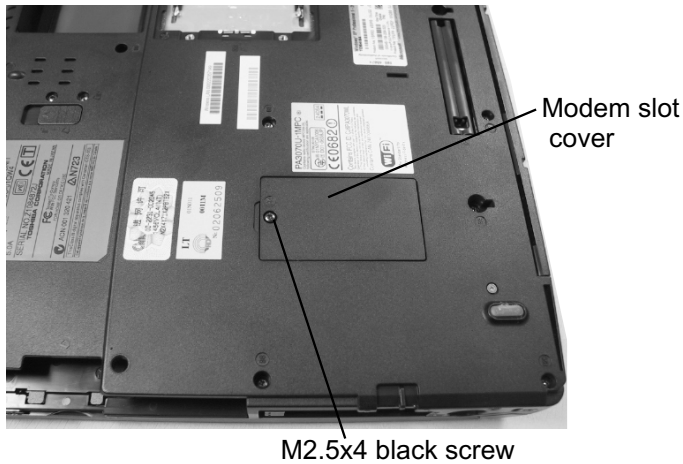

1. Remove **one M2.5x4 black screw** securing the modem slot cover.
2. Insert your finger nail or the case separator into the notched side of the cover and lift up to release the two latches securing the left side of the modem slot cover.

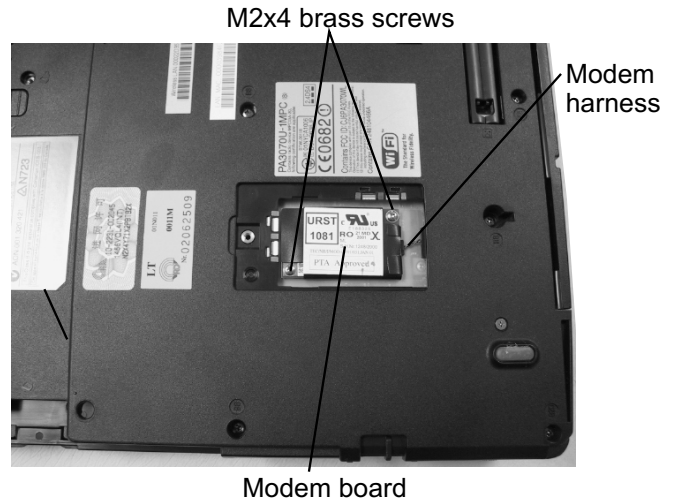

3. Disconnect the **modem harness** from the modem board.
4. Remove **two M2x4 brass screws** securing the modem board.
5. Lift up the **modem board** to disconnect it from the system board.

HDD REMOVAL

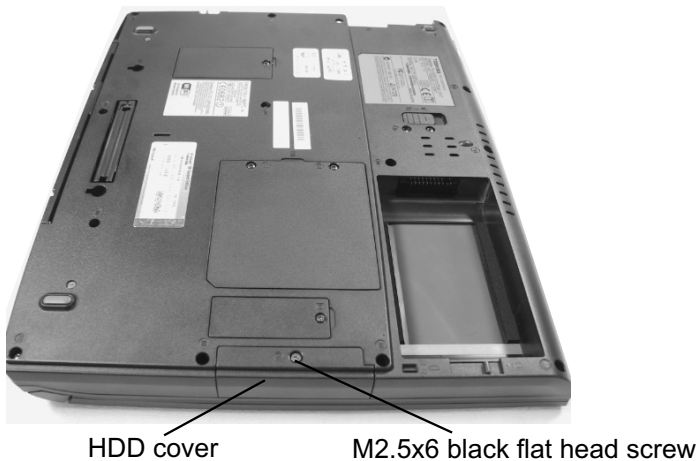

1. Turn the computer upside down.
2. Remove **one M2.5x6 black flat head screw** securing HDD cover.
3. Remove the **HDD cover**.

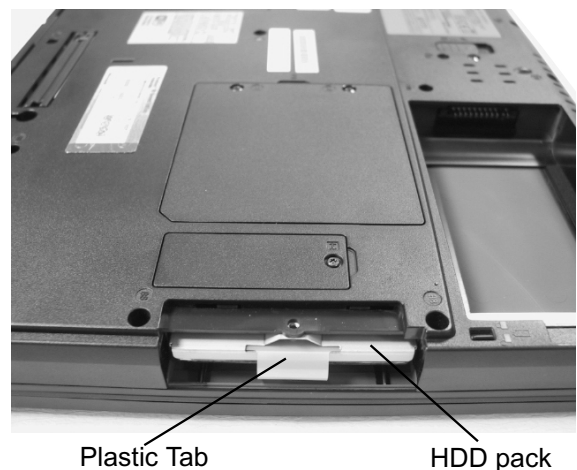

4. Unfold the **plastic tab** and pull to remove the HDD from the bay.

TOSHIBA

Tough Enough for Today's World.

FIELD REPLACEABLE UNIT DOCUMENTATION

Satellite Pro™ 6000 Series

HDD REMOVAL

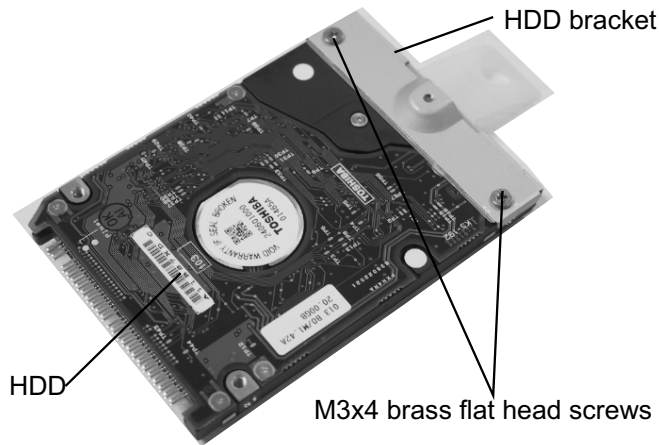

5. Remove **two M3x4 brass flat head screws** securing the HDD to the bracket and remove the HDD bracket.

KEYBOARD REMOVAL

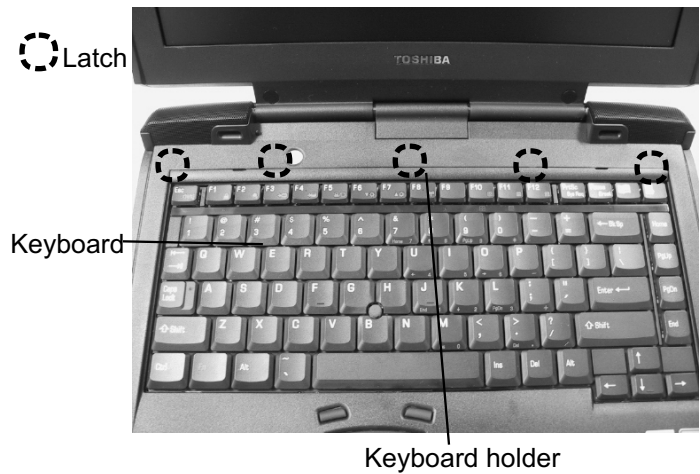

1. Turn the computer right side up and open the display panel.
2. Using the **case separator**, unlatch the **keyboard holder** at the top of the **keyboard**.

KEYBOARD REMOVAL



3. Remove **two M2.5x2.6 black screws** securing the keyboard.



4. Lift out the **keyboard** and set it as shown above.
5. Disconnect the **keyboard cable** from **PJ445** on the system board.

TOSHIBA

Tough Enough for Today's World.

FIELD REPLACEABLE UNIT DOCUMENTATION

Satellite Pro™ 6000 Series

WIRELESS LAN CARD REMOVAL

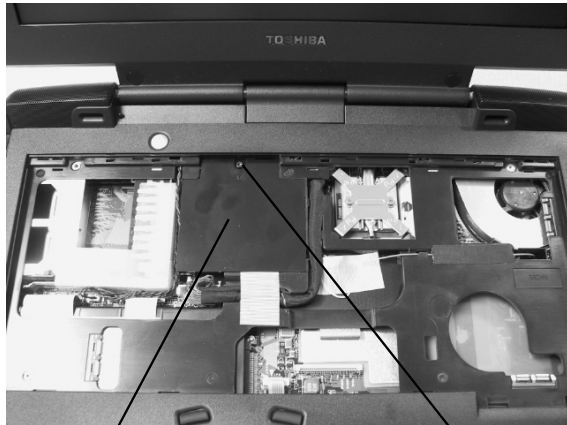

Mini PCI cover M2.5x4 security torx screw

1. Remove **one M2x4 security torx screw** securing the mini PCI cover and lift out the cover.



Mini-PCI connector clips
Wireless LAN card Black coax cable White coax cable

2. Disconnect the **black and white coax** from the wireless LAN card.
3. Spread the **Mini-PCI connector clips** and pull the **Wireless LAN card** out of the connector about 45 degree angle.

TOP COVER REMOVAL

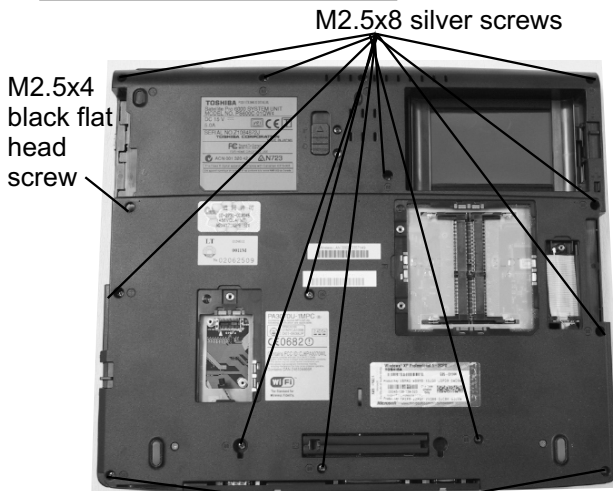

M2.5x8 silver screws

M2.5x4 black flat head screw

M2.5x20 black screws

1. Turn the computer upside down and remove the following screws:
 - 12 **M2.5x8 black screws**
 - 1 **M2.5x4 black flat head screw**
 - 2 **M2.5x20 black screws**

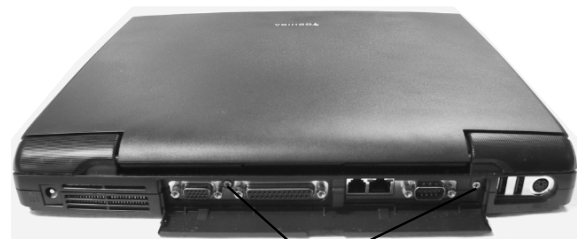

M2.5x4 black flat head screws

2. Turn the computer right side up with the rear facing you.
3. Remove **two M2.5x4 black flat head screws** securing the top cover.

TOSHIBA

Tough Enough for Today's World.

FIELD REPLACEABLE UNIT DOCUMENTATION

Satellite Pro™ 6000 Series

TOP COVER REMOVAL

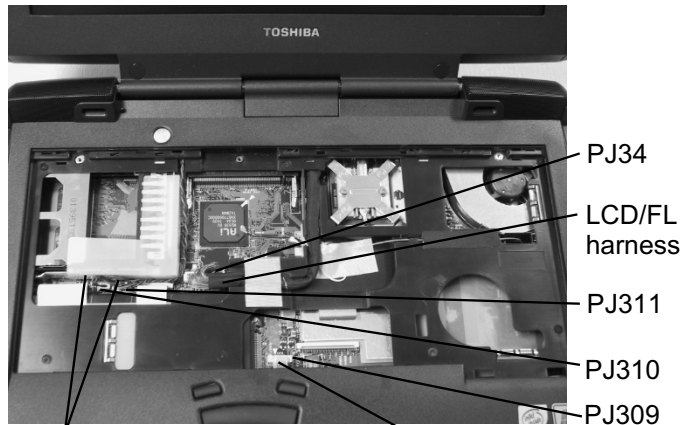

Left/Right speaker cable IPS membrane switch

3. Disconnect the **left speaker cable** from **PJ310** and the **right speaker cable** from **PJ311** on the top board.
4. Disconnect the **LCD/FL harness** from **PJ34** and the **IPS membrane switch** from **PJ311** on the system board.
5. Lift out the **top cover assembly**.

Note: When installing the top cover, ensure that the bluetooth coaxial cable is properly routed to the Bluetooth slot.

CPU REMOVAL

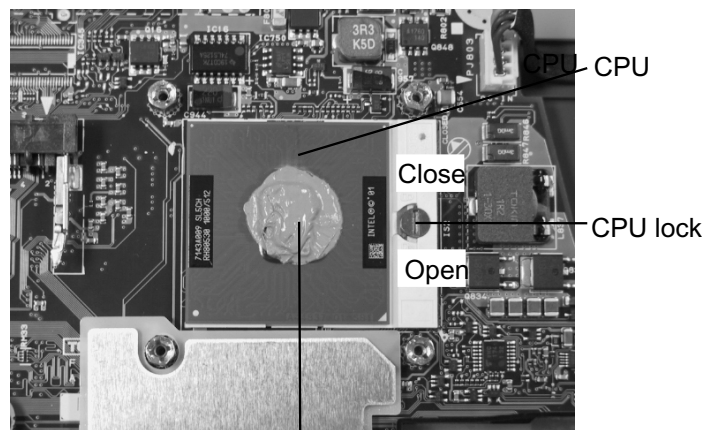

Silicone grease

1. Insert a **flat head screwdriver** in the **CPU lock** and rotate it counter-clockwise to unlock the **CPU**.
2. Lift out the **CPU**.

NOTE: When installing the CPU, make sure that a silicone grease is applied before attaching the heat sink. Please refer to FSB-200112 for the complete procedures on how to apply the silicone grease.

COOLING MODULE REMOVAL

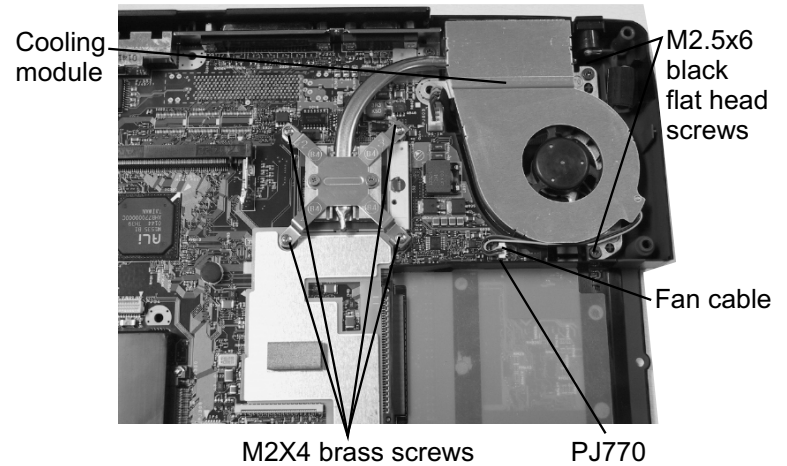

1. Disconnect the **fan cable** from **PJ770** on the top board.
2. Remove **two M2.5x6 black flat head screws** and **four M2x4 brass screws** securing the cooling module.
3. Lift out the **cooling module**.

RTC BATTERY REMOVAL

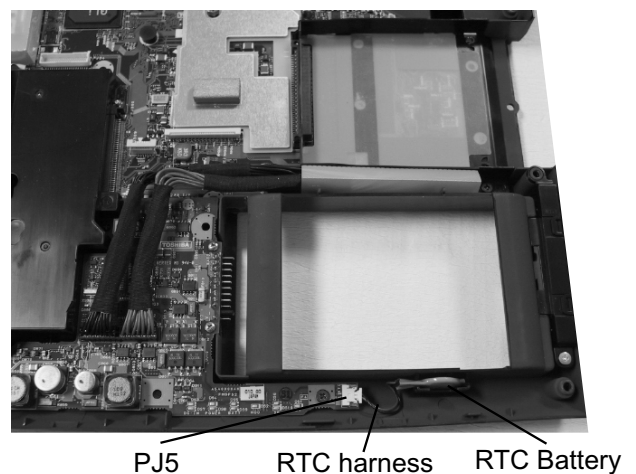

1. Disconnect the **RTC harness** from **PJ5** on the Battery/LED board.
2. Lift out the **RTC battery**.

TOSHIBA

Tough Enough for Today's World.

FIELD REPLACEABLE UNIT DOCUMENTATION

Satellite Pro™ 6000 Series

POWER SUPPLY BOARD REMOVAL

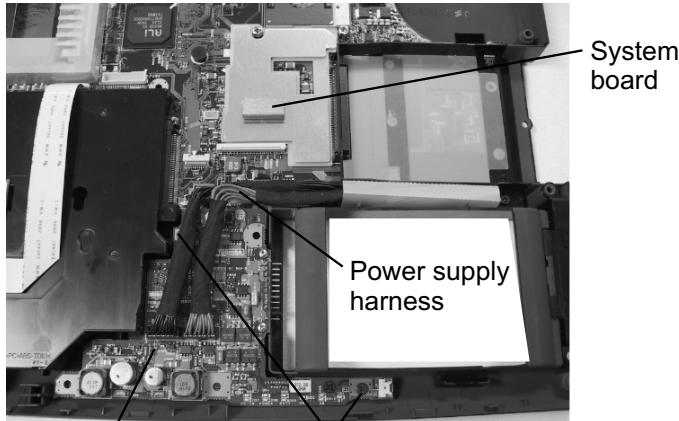

Power supply board M2.5x4 black flat head screws

1. Disconnect the **power supply harness** from **PJ850** and **PJ851** on the system board.
2. Remove **two M2.5x4 black flat head screws** securing the power supply board.
3. Disconnect the **power supply board** from the system board.

SD/SOUND BOARD REMOVAL

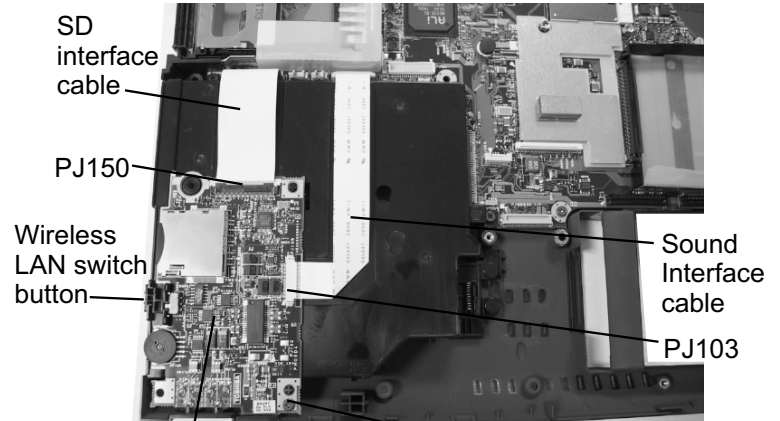

SD/Sound board M2.5x4 black flat head screw

1. Disconnect the **sound interface cable** from **PJ103** and the **SD interface cable** from **PJ150** on the SD/Sound board.
2. Remove **one M2.5x4 black flat head screw** securing the SD/Sound board.
3. Remove the **wireless LAN switch button**.
4. Lift out the **SD/Sound board**.

SYSTEM BOARD REMOVAL

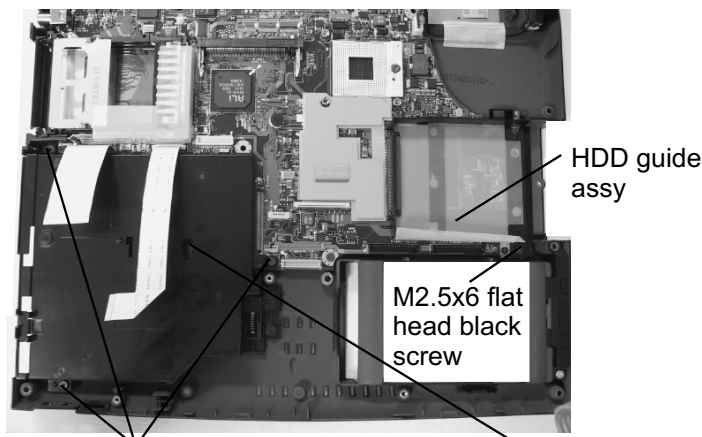

M2.5x6 black flat head screws Select bay cover

1. Remove **one M2.5x6 black flat head screw** securing the HDD guide assembly and lift out the **HDD guide assembly**.
2. Remove **three M2.5x6 black flat head screws** securing the select bay cover and lift out the **select bay cover**.

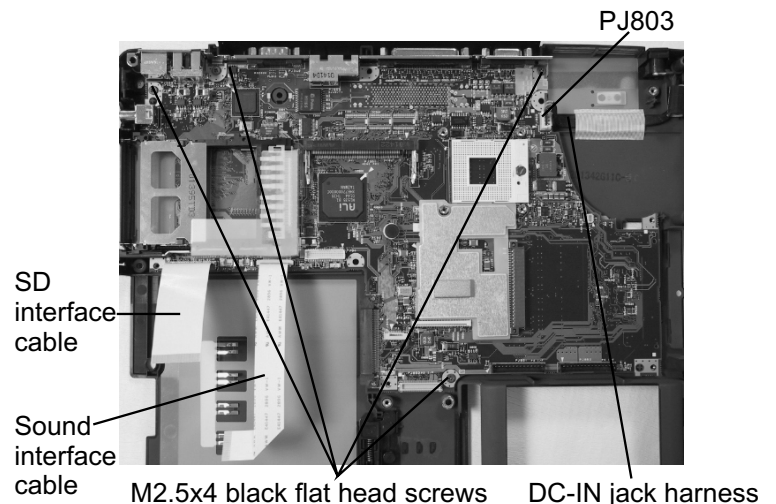

3. Disconnect following cables from the system board:
 - Sound interface cable** from **PJ103**
 - SD interface cable** from **PJ150**
 - DC-IN jack harness** from **PJ803**
4. Remove **four M2.5x4 black flat head screws** securing the system board.
5. Lift out the **system board**.

TOSHIBA

Tough Enough for Today's World.

FIELD REPLACEABLE UNIT DOCUMENTATION

Satellite Pro™ 6000 Series

MEMBRANE SWITCH REMOVAL

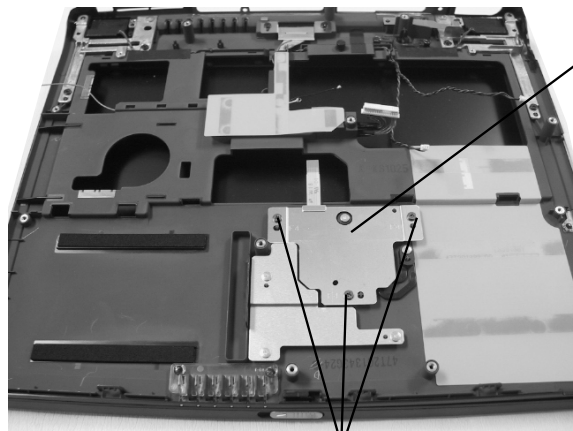

M2.5x4 black flat head screws

1. Remove **three M2.5x4 black flat head screws** securing the membrane switch.
2. Lift out the **membrane switch assembly**.

SPEAKERS REMOVAL

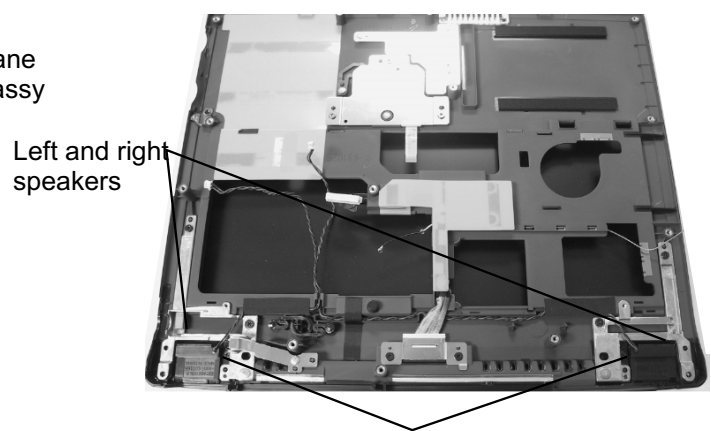

M2.5x4 black flat head screws

1. Remove **two M2.5x4 black flat head screws** securing the left and right speakers.

SPEAKERS REMOVAL

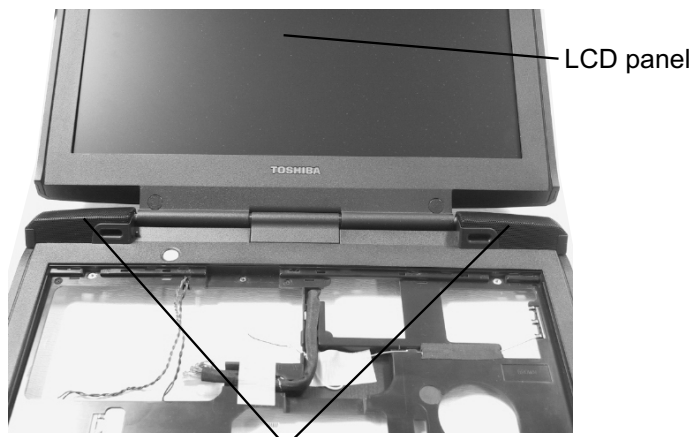

Left and Right speakers

2. Turn the display assembly right side up and open the **LCD panel**.
3. Lift out the **left and right speakers**.

TOSHIBA

Tough Enough for Today's World.

FIELD REPLACEABLE UNIT DOCUMENTATION

Satellite ProTM 6000 Series

14.1" DISPLAY MASK REMOVAL

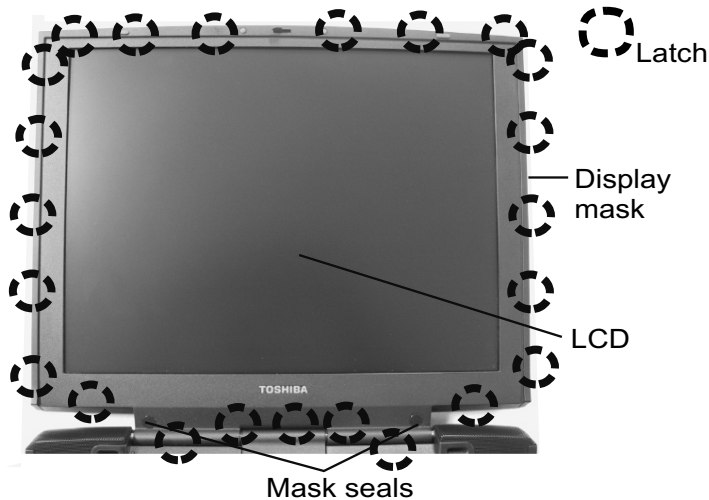

1. Remove **two mask seals** at the bottom corners of the display assembly using a pair of fine-tipped tweezers.
2. Remove **two M2.5x6 black flat head screws** securing the display mask.
3. There are **23 latches** securing the **display mask**. Carefully insert your fingers between the mask and the LCD panel and pry open the latches starting from the **six top latches**, to the **five latches on each right and left sides**, ending with the **bottom seven latches**.

FL INVERTER AND 14.1" LCD REMOVAL

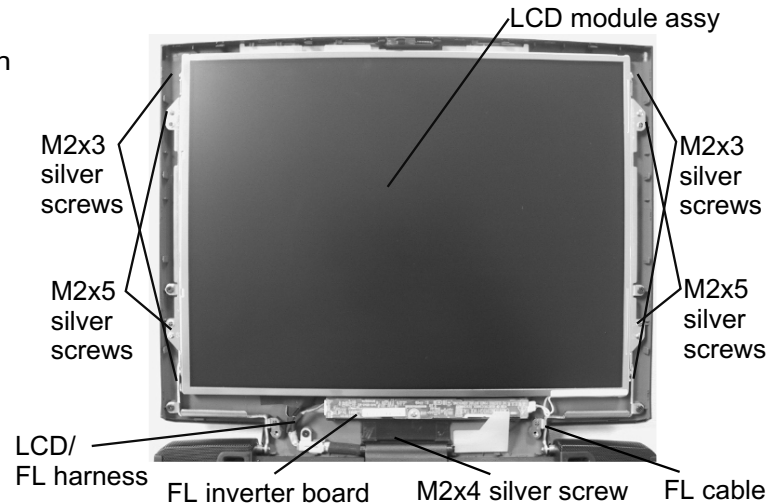

1. Remove **one M2x4 silver screw** securing the FL inverter board.
2. Carefully lift up the **FL inverter board** and disconnect the **LCD/FL cable** from **CN1** and the **FL cable** from **CN2**.
3. Remove **four mask seals** to expose four screws securing the LCD module assembly.
4. Remove **four M2x5 silver screws** securing the **LCD module assembly**.
5. Carefully rotate out the top of the **LCD module** enough to access the display cable
6. Peel off the tape securing the LCD/FL cable and disconnect the cable.
7. Remove **four M2x3 silver screws** securing the right and left LCD brackets.

TOSHIBA

Tough Enough for Today's World.