

PCM-4897

All-in-One Media GXm CPU Card
with LCD, TV-Output, Audio, &
2 COMs

FCC STATEMENT

THIS DEVICE COMPLIES WITH PART 15 FCC RULES. OPERATION IS SUBJECT TO THE FOLLOWING TWO CONDITIONS: (1) THIS DEVICE MAY NOT CAUSE HARMFUL INTERFERENCE. (2) THIS DEVICE MUST ACCEPT ANY INTERFERENCE RECEIVED INCLUDING INTERFERENCE THAT MAY CAUSE UNDESIRE OPERATION.

THIS EQUIPMENT HAS BEEN TESTED AND FOUND TO COMPLY WITH THE LIMITS FOR A CLASS "A" DIGITAL DEVICE, PURSUANT TO PART 15 OF THE FCC RULES. THESE LIMITS ARE DESIGNED TO PROVIDE REASONABLE PROTECTION AGAINST HARMFUL INTERFERENCE WHEN THE EQUIPMENT IS OPERATED IN A COMMERCIAL ENVIRONMENT. THIS EQUIPMENT GENERATES, USES, AND CAN RADIATE RADIO FREQUENCY ENERGY AND, IF NOT INSTALLED AND USED IN ACCORDANCE WITH THE INSTRUCTION MANUAL, MAY CAUSE HARMFUL INTERFERENCE TO RADIO COMMUNICATIONS. OPERATION OF THIS EQUIPMENT IN A RESIDENTIAL AREA IS LIKELY TO CAUSE HARMFUL INTERFERENCE IN WHICH CASE THE USER WILL BE REQUIRED TO CORRECT THE INTERFERENCE AT HIS OWN EXPENSE.

Copyright Notice

This document is copyrighted, 1999. All rights are reserved. The original manufacturer reserves the right to make improvements to the products described in this manual at any time without notice.

No part of this manual may be reproduced, copied, translated, or transmitted in any form or by any means without the prior written permission of the original manufacturer. Information provided in this manual is intended to be accurate and reliable. However, the original manufacturer assumes no responsibility for its use, nor for any infringements upon the rights of third parties which may result from its use.

Acknowledgements

AMI is a trademark of American Megatrends, Inc.

Award is a trademark of Award Software International, Inc.

Cyrix is a trademark of Cyrix Corporation.

IBM, PC/AT, PS/2, and VGA are trademarks of International Business Machines Corporation.

Microsoft Windows® is a registered trademark of Microsoft Corp.

SMC is a trademark of Standard Microsystems Corporation.

UMC is a trademark of United Microelectronics Corporation.

NS is a trademark of National Semiconductor, Inc.

All other product names or trademarks are properties of their respective owners.

A Message to the Customer

AAEON Customer Services

Each and every AAEON product is built to the most exacting specifications to ensure reliable performance in the harsh and demanding conditions typical of industrial environments. Whether your new AAEON equipment is destined for the laboratory or the factory floor, you can be assured that your product will provide the reliability and ease of operation for which the name AAEON has come to be known.

Your satisfaction is our primary concern. Here is a guide to AAEON's customer services. To ensure you get the full benefit of our services, please follow the instructions below carefully.

Technical Support

We want you to get the maximum performance from your products. So if you run into technical difficulties, we are here to help. For the most frequently asked questions, you can easily find answers in your product documentation. These answers are normally a lot more detailed than the ones we can give over the phone.

So please consult this manual first. If you still cannot find the answer, gather all the information or questions that apply to your problem, and with the product close at hand, call your dealer. Our dealers are well trained and ready to give you the support you need to get the most from your AAEON products. In fact, most problems reported are minor and are able to be easily solved over the phone.

In addition, free technical support is available from AAEON engineers every business day. We are always ready to give advice on application requirements or specific information on the installation and operation of any of our products.

Product Warranty

AAEON warrants to you, the original purchaser, that each of its products will be free from defects in materials and workmanship for one year from the date of purchase.

This warranty does not apply to any products which have been repaired or altered by persons other than repair personnel authorized by AAEON, or which have been subject to misuse, abuse, accident or improper installation. AAEON assumes no liability under the terms of this warranty as a consequence of such events.

Because of AAEON's high quality-control standards and rigorous testing, most of our customers never need to use our repair service. If an AAEON product is defective, it will be repaired or replaced at no charge during the warranty period. For out-of-warranty repairs, you will be billed according to the cost of replacement materials, service time, and freight. Please consult your dealer for more details.

If you think you have a defective product, follow these steps:

1. Collect all the information about the problem encountered. (For example, CPU type and speed, AAEON products used, other hardware and software used, etc.) Note anything abnormal and list any on-screen messages you get when the problem occurs.
2. Call your dealer and describe the problem. Please have your manual, product, and any helpful information readily available.
3. If your product is diagnosed as defective, obtain an RMA (return material authorization) number from your dealer. This allows us to process your return more quickly.
4. Carefully pack the defective product, a fully-completed Repair and Replacement Order Card and a photocopy proof of purchase date (such as your sales receipt) in a shippable container. A product returned without proof of the purchase date is not eligible for warranty service.
5. Write the RMA number visibly on the outside of the package and ship it prepaid to your dealer.

Packing list

Before you begin installing your card, please make sure that the following materials have been shipped:

- 1 PCM-4897 All-in-One MediaGXm CPU Card
- 1 Quick Installation Guide
- 1 Supporting CD-ROM contains the followings:
 - User's Manual (this manual in PDF file)
 - VGA drivers and utilities
 - Audio drivers and utilities
 - Latest BIOS (as of the CD-ROM was made)
- 1 hard disk drive (IDE) interface cable (44 pins)
- 1 floppy disk drive interface cable (34 pins)
- 1 6 pins mini-DIN dual outlet adapter for keyboard and PS/2 mouse

If any of these items are missing or damaged, contact your distributor or sales representative immediately.

Notice

Dear Customer,

Thank you for purchasing the PCM-4897 board. This user's manual is designed to help you to get the most out of the PCM-4897, please read it thoroughly before you install and use the board. The product that you have purchased comes with two year limited warranty, but AAEON will not be responsible for misuse of the product. Therefore, we strongly urge you to first read the manual before using the product.

To receive the latest version of the user manual, please visit our Web site at:

<http://www.aaeon.com>

Contents

Chapter 1: General Information	1
Introduction	2
Features	3
Specifications	4
Board layout	7
Board dimensions	8
Chapter 2: Installation	9
Jumpers and connectors	10
Locating jumpers	12
Locating connectors	13
Setting jumpers	14
CPU installing and upgrading	15
Installing DRAM (DIMMs)	16
CPU frequency ratio select (JBFA1)	17
CPU clock select (JCLK1).....	18
ATX power connector (PW1)	19
IrDA connector (JSIR1)	20
Wake up on modem connector (JWOM1)	21
LCD Backlight power connector (J1).....	22
Composite video output connector (J2).....	23
S-Video connector (J3)	24
Internal/external buzzer select (JP1).....	25
Hardware reset (JP2)	26
ATX Soft-Power Switch connector (JP3)	27
Power on LED (JP4).....	28
Suspend switch & LED (JP5, JP6)	29
IDE LED connector (JP7)	30
DOC address select (JP8).....	31
CPU fan power connector (JP9)	33
Wake On LAN connector (JP11).....	34

Clear CMOS (JP13)	35
LCD backlight voltage select (JP14)	36
Power LED and KB lock connector (JP15)	37
LCD driving voltage select (JP16)	38
IDE hard drive connector (CN1)	39
Connecting the hard drive	40
IDE hard drive connector (CN1)	41
Game/Joystick/MIDI connector (CN2)	42
Floppy drive connector (CN3)	43
Connecting the floppy drive	44
Floppy drive connector (CN3)	45
Display connector (CN8, CN4)	46
LCD connector (CN4)	47
CD-ROM signal input connector (CN6)	48
Audio connector (for voice modem)(CN7)	49
Parallel port connector (CN9)	50
USB connector (CN10)	51
Audio signal input connector (CN11)	52
MIC signal input connector (CN13)	53
Keyboard and PS/2 mouse connector (CN14)	54
Serial ports (COM1/COM2, CN15/CN16)	55
COM 1-2 RS-232 serial ports (CN15/CN16)	55
DiskOnChip socket (U4)	56
DiskOnChip (DOC) 2000 Installation	57

Chapter 3: Award BIOS Setup **59**

Starting setup	60
Setup keys	61
Getting help	62
In case of problem	62
Main setup menu	63
Standard CMOS setup	65

BIOS features setup	71
CHIPSET features setup	75
Power management setup	77
PNP/PCI configuration setup	80
Load BIOS defaults/Load setup defaults	82
Integrated peripherals setup	83
Supervisor/User password setting	84
IDE HDD auto detection	88
Save & exit setup	89
Exit without saving	90

Chapter 4: C&T 69000 Flat Panel/CRT controller Display Drivers and Utilities 91

Software drives	92
Hardware configuration	92
Necessary prerequisites	93
Before you begin	93
Windows 95	94
Driver installation	94
Windows 3.1	102
Driver installation	102
OS/2	103
Windows NT 3.51	105
Driver installation	105
Windows NT 4.0	106
Driver installation	106

Chapter 5: Audio setup 107

Introduction	108
Setting up in windows 95	108
Installing the drivers under Window 95	109

General Information

This chapter gives background information on the mainboard.

Sections include:

- Board specifications
- Layout and dimensions

Introduction

The PCM-4897 is an all-in-one multi-media Cyrix MediaGX MMX (abbreviated as GXm) processor based single board computer (SBC) with an integrated audio and video controller, a PCI Flat Panel controller, and one PISA expansion slot. With true Pentium MMX capability, the PCM-4897 achieves outstanding performance that surpasses other SBC in its class. In addition, the onboard SSD interface supports M-Systems DiskOnChip 2000 series, memory capacity from 2 MB to 144 MB. This compact (only 6.378" x 7.87") unit offers all the functions of a single board industrial computer.

Onboard features include two serial ports, one multi-mode parallel (ECP/EPP/SPP) port, connector for two USB (Universal Serial Bus) connector, a floppy drive controller, and a keyboard/PS/2 mouse interface. The built-in high speed PCI IDE controller supports Ultra DMA/33 mode. Up to two IDE devices can be connected, including large hard disks, CD-ROM drives, and tape backup drives, etc.

The PCM-4897 also features power management to minimize power consumption. It complies with the ACPI standard and supports two types of power saving features: Doze mode, Standby mode. In addition, the board's watchdog timer can automatically reset the system or generate an interrupt in case the system stops due to a program bug or EMI.

Highly integrated multi-media SBC

The PCM-4897 is a highly integrated multi-media SBC that combines audio, video, and TV-Output functions on a CD-ROM drive size single computer board. It provides, 16-bit full-duplex, integrated 3D audio and up to 1024 x 768 resolution @ 64K colors. Major onboard devices adopt PCI technology to achieve outstanding computing performance.

Features

- Supports Cyrix MediaGX MMX CPU 200~300 MHz
- DiskOnChip (SSD) up to 144MB
- 18-bit PCI-bus SVGA/LCD controller supports LCD & CRT display
- AC-97 2.0 audio interface, Sound Blaster compatible
- Supports Bus Master and Ultra DMA/33 IDE devices
- Two RS-232 serial ports
- USB interface & PISA slot for flexible expansion capabilities

Specifications

Standard SBC Functions

- **CPU:** Cyrix MediaGX MMX 200~300MHz
- **CPU socket:** Socket 7
- **BIOS:** Award 256KB Flash BIOS
- **Chipset:** Cyrix Media GX MMX/Cx5530
- **I/O Chipset:** NS97317
- **Memory:** Onboard one 168 pins DIMM socket supports up to 128Mbytes SDRAM
- **Enhanced IDE:** Support up to two IDE devices. Supports Ultra DMA/33 mode with data transfer rate up to 33MB/sec.
- **FDD interface:** Supports up to two floppy disk drives, 5.25" (360KB and 1.2MB) and/or 3.5" (720KB, 1.44MB, and 2.88MB)
- **Parallel port:** One bi-directional parallel port. Supports SPP, ECP and EPP modes
- **Serial ports:** Two RS-232 serial ports. Ports can be configured as COM1, COM2, COM3, COM4, or disabled individually. (16C550 equivalent)
- **IR interface:** Supports one IrDA Tx/Rx header
- **Keyboard/mouse connector:** 6 pins mini-Din connector supports PC/AT keyboard and PS/2 mouse
- **USB connectors:** Two USB ports onboard
- **Battery:** Lithium battery for data retention of up to 10 years
- **DMA:** 7 DMA channels (8237 equivalent)
- **Interrupt:** 15 interrupt levels (8259 equivalent)
- **Power management:** Supports ATX power supply. Supports PC97, LAN wake up, and modem ring-in functions. I/O peripheral devices support power saving and doze/standby/suspend modes. APM 1.2 compliant

Flat Panel/CRT Interface

- **Chipset:** Cyrix Cx 5530
- **Display memory:** UMA
- **Display type:** Supports non-interlaced CRT and LCD (TFT) displays. Can display both CRT and Flat Panel simultaneously
- **Resolution:** Up to 1024x768@64K colors

Sound Interface

- **Chipset:** Cyrix Cx5530
- **3D audio:** Supports for Microsoft DirectSound and DirectSound 3D audio technology in two-speaker mode (requires Microsoft Direct Sound 3D supported software titles)
- **16-bit stereo digital audio:** Full-duplex support enables simultaneous record and playback for Internet communications software

TV-Output

- **Chipset:** Chronitel 7003 supports both PAL and NTSC system

SSD Interface

One 32-pin DIP socket supports M-systems DiskOnChip 2000 Series up to 144MB

Expansion Slots

- **PISA slot:** One PISA slot onboard for expansion

Mechanical and environmental

- **Power supply voltage:** +5V (4.75V to 5.25V),
+12V (11.4V to 12.6V)
- **Power requirement:** +5V@0.8A (Cyrix GXm 200MHz)
- **Operating temperature:** 32 to 140°F (0 to 60°C)
- **Board size:** 8"(L) x 5.75"(W) (203mm x 146mm)
- **Weight:** 1.2 lb. (0.5 Kg)

Board layout

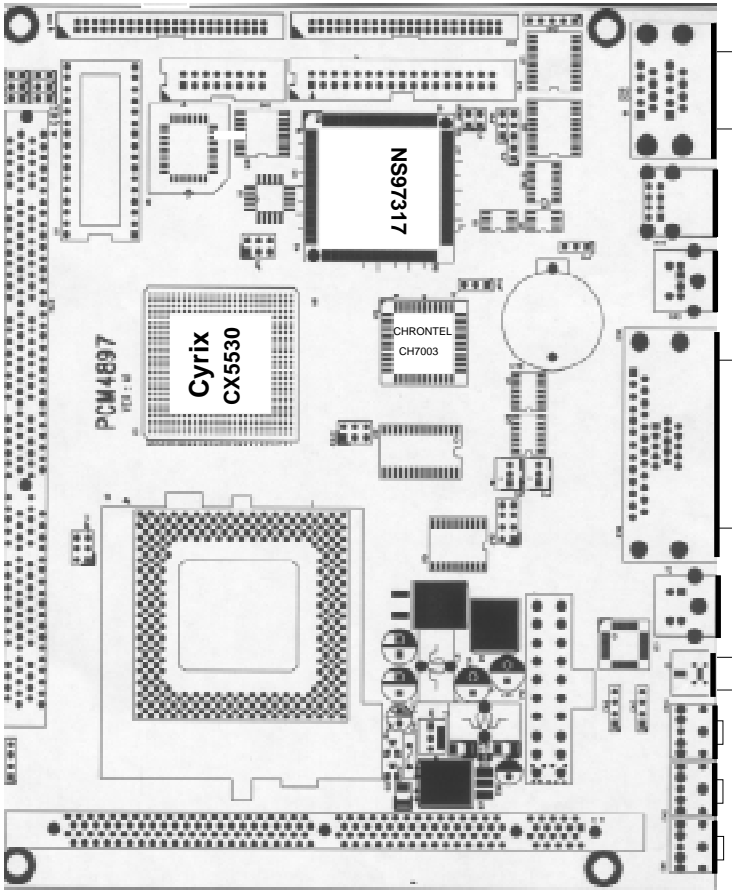

Board dimensions

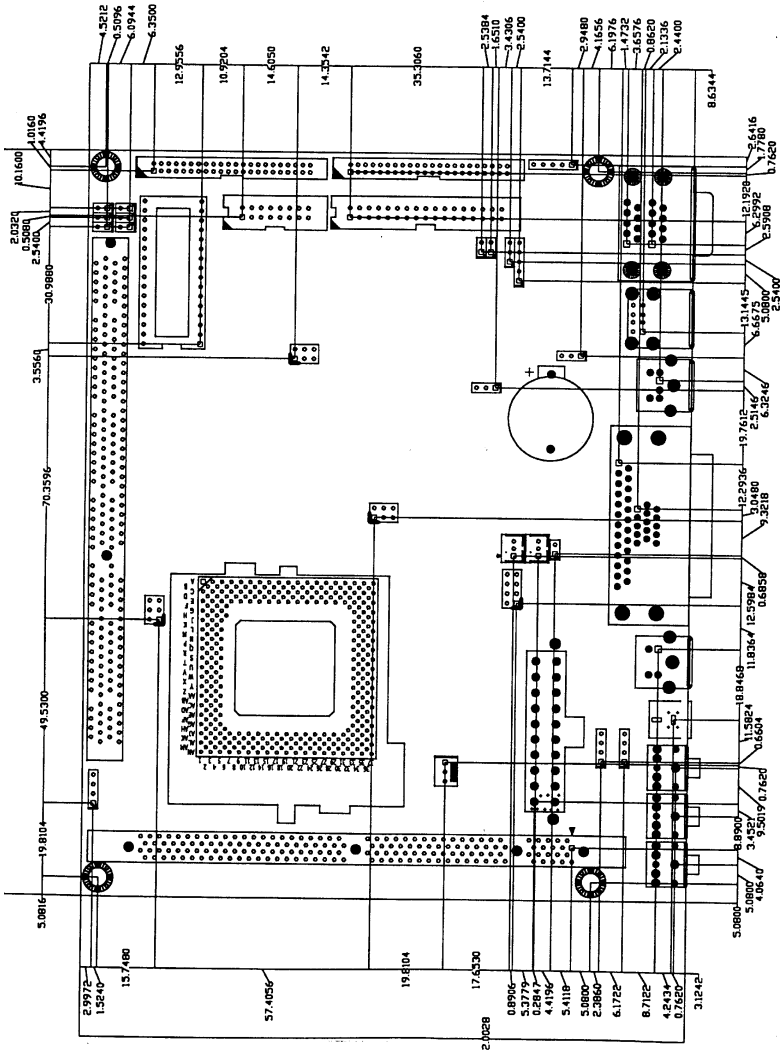

Installation

This chapter describes how to set up the main board hardware, including instructions on setting jumpers and connecting peripherals, switches, and indicators. Be sure to read all the safety precautions before you begin the installation procedure.

Jumpers and connectors

Connectors on the board link it to external devices such as hard disk drives, a keyboard, or floppy drives. In addition, the board has a number of jumpers that allow you to configure your system to suit your application.

The following tables list the function of each of the board's jumpers and connectors.

Jumpers

Label	Function
JCLK1	CPU clock select
JBFA1	CPU frequency ratio select
PW1	ATX power connector
JSIR1	IrDA connector
JWOM1	Wake up on modem connector
J1	Backlight power connector
J2	Composite video connector
J3	S-Video connector
JP1	Internal/external buzzer select
JP2	Hardware reset connector
JP3	ATX soft-power switch connector
JP4	Power on LED connector
JP5	Suspend Switch (Green mode)
JP6	Suspend LED connector
JP7	HDD LED connector
JP8	DOC address select
JP9	CPU fan power connector
JP11	Wake on LAN connector
JP13	Clear CMOS
JP14	LCD backlight voltage select
JP15	Power LED & KB lock connector
JP16	LCD driving voltage select

Connectors

Label	Function
CN1	IDE drive connector
CN2	Game port connector
CN3	Floppy drive connector
CN4	LCD display connector
CN6	CD-ROM signal input connector
CN7	Audio connector (for voice modem)
CN8	VGA Display connector
CN9	Parallel port connector
CN10	USB connector
CN11	Audio signal output connector
CN12	Audio signal input connector
CN13	MIC signal input connector
CN14	KB & PS/2 mouse connector
CN15	COM1 connector
CN16	COM2 connector

Locating jumpers

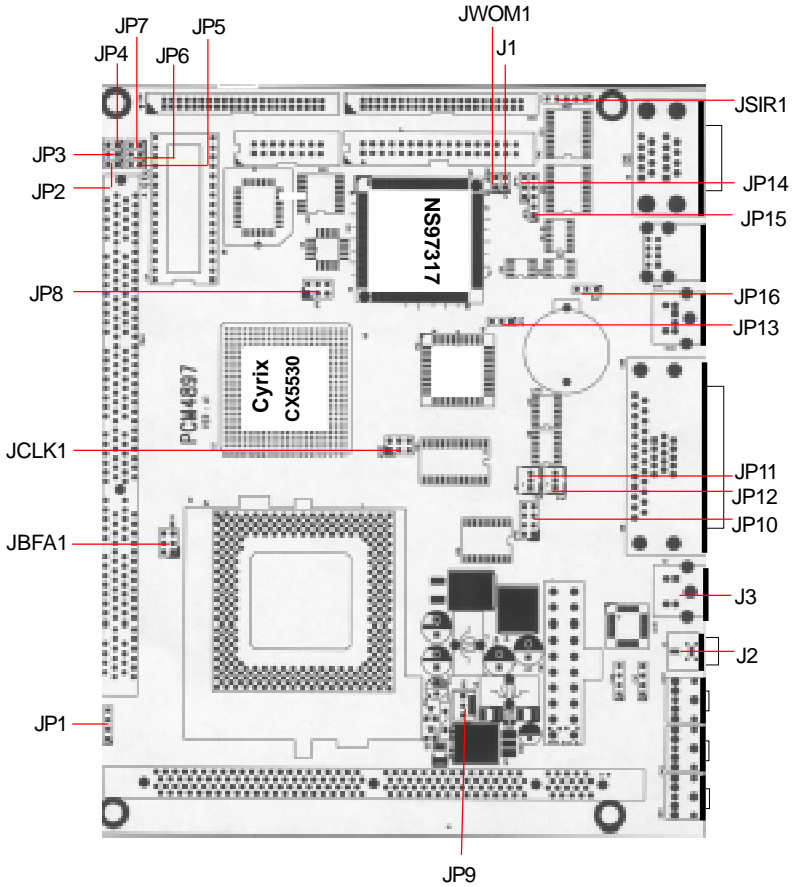

Locating connectors

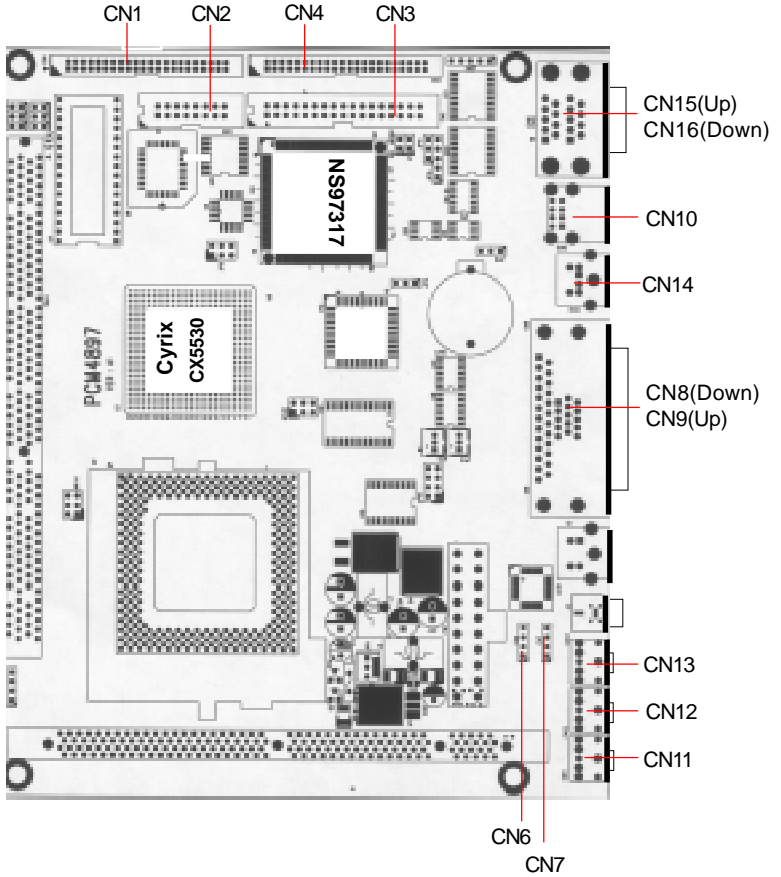

Setting jumpers

You can configure your card to match the needs of your application by setting jumpers. A jumper is the simplest kind of electric switch. It consists of two metal pins and a small metal clip (often protected by a plastic cover) that slides over the pins to connect them. To “close” a jumper you connect the pins with the clip. To “open” a jumper you remove the clip. Sometimes a jumper will have three pins, labeled 1, 2, and 3. In this case you would connect either pins 1 and 2 or 2 and 3.

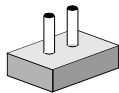

Open

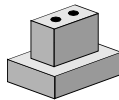

Closed

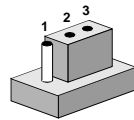

Closed 2-3

The jumper settings are schematically depicted in this manual as follows:



Open



Closed



Closed 2-3

A pair of needle-nose pliers may be helpful when working with jumpers.

If you have any doubts about the best hardware configuration for your application, contact your local distributor or sales representative before you make any changes.

CPU installing and upgrading

You can upgrade to a more powerful Cyrix GXm CPU at any time. Simply remove the old CPU, install the new one, and set the jumpers for the new CPU speed.

Warning! *Always disconnect the power cord from your chassis when you are working on it. Do not make connections while the power is on as sensitive electronic components can be damaged by the sudden rush of power. Only experienced electronics personnel should open the PC chassis.*



Caution! *Always ground yourself to remove any static charge before touching the PC board. Modern electronic devices are very sensitive to static electric charges. Use a grounding wrist strap at all times. Place all electronic components on a static-dissipative surface or in a static-shielded bag when they are not in the chassis.*



When you install a new CPU, be sure to adjust the board settings, such as CPU frequency ratio. **Improper settings may damage the CPU.**

Installing DRAM (DIMMs)

System Memory

The PCM-4897 contains a socket for 168-pin dual inline memory module (DIMM). The socket uses 3.3 V unbuffered synchronous DRAM (SDRAM). DIMM is available in capacities of 16, 32, 64, or 128 MB. The socket can be filled in the DIMM of any size, giving your PCM-4897 single board computer between 16 and 128 MB of memory.

Supplementary information about DIMM

Your PCM-4897 can accept both regular and PC-100 SDRAM DIMM Module(with or without parity).

Single-sided modules are typically 16 or 64 MB; double-sided modules are usually 32 or 128 MB.

Memory Installation Procedures

To install DIMM, first make sure the two handles of the DIMM socket are in the "open" position. i.e. The handles remain outward. Slowly slide the DIMM module along the plastic guides on both ends of the socket. Then press the DIMM module right down into the socket, until you hear a click. This is when the two handles have automatically locked the memory module into the correct position of the DIMM socket. (See Figure below) To take away the memory module, just push both handles outward, and the memory module will be ejected by the mechanism in the socket.

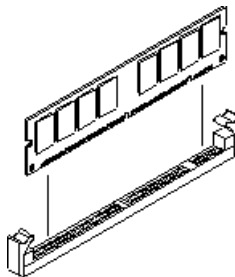

CPU frequency ratio select (JBFA1)

The GXm CPU core frequency = CPU frequency ratio (4~10X) *
 External CPU clock (33 or 30MHz). The following table shows the
 available configurations.

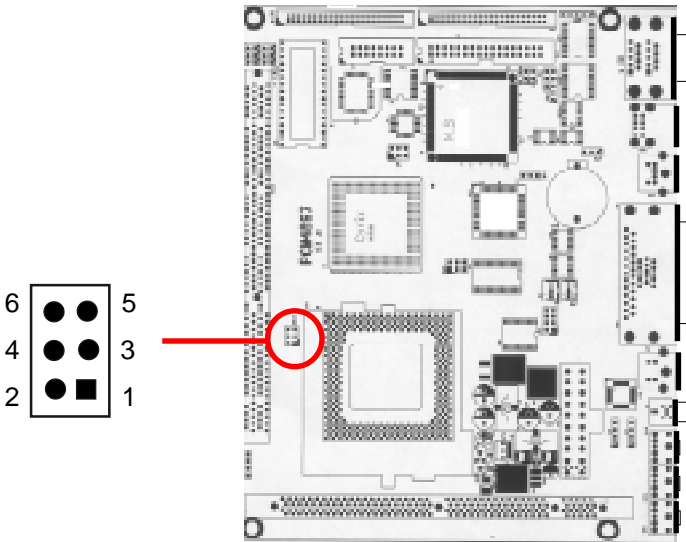

* For GXm >= 266MHz

Ratio \ JBFA1	1-2	3-4	5-6
5X	ON	OFF	OFF
6X *	OFF	ON	OFF
7X	OFF	OFF	ON
8X	ON	ON	ON
9X	ON	OFF	ON
10X	ON	ON	OFF

* For GXm = 233MHz, 200MHz

	1-2	3-4	5-6
4X	X	ON	ON
6X	X	ON	OFF
7X	X	OFF	ON
8X	X	OFF	OFF

* default

* ON : Short with the jumper cap

OFF: Open without the jumper cap

CPU clock select (JCLK1)

You can configure the CPU external clock to 33MHz or 30MHz by setting JCLK1.

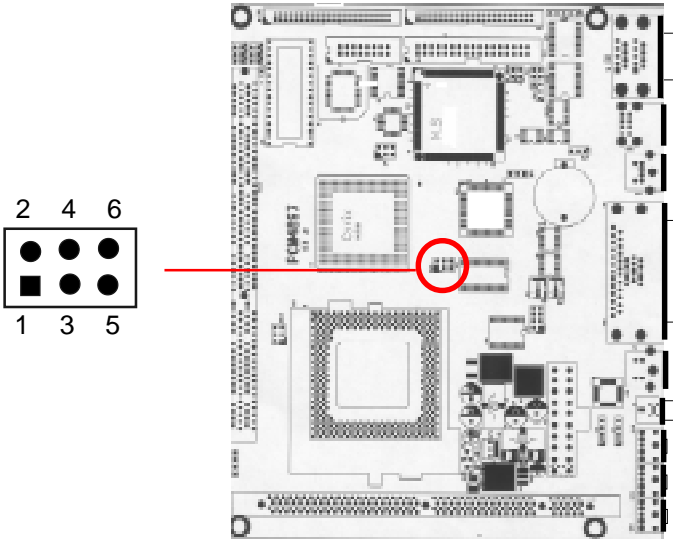

Freq. \ JCLK1	1-3	2-4	3-5	4-6
30 MHz	OFF	OFF	OFF	ON
33 MHz *	OFF	ON	OFF	OFF

* default

* ON : Short with the Jumper cap

OFF : Open without the jumper cap

ATX power connector (PW1)

The ATX power supply uses a 20-pin connector shown below. Make sure you plug in the right direction.

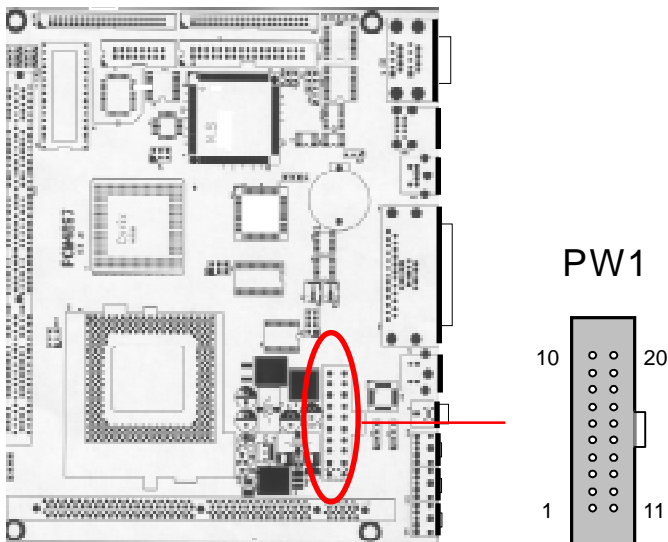

ATX power connector (PW1)

Pin	Signal	Pin	Signal
1	N/C	11	N/C
2	N/C	12	-12V
3	GND	13	GND
4	+5V	14	PON
5	GND	15	GND
6	+5 V	16	GND
7	GND	17	GND
8	N/C	18	-5V
9	5V SB	19	+5V
10	+12V	20	+5V

IrDA connector (JSIR1)

The IrDA connector JSIR1 can be configured to support wireless infrared module. With this module and application software such as laplink or Win95 Direct Cable connection, user can transfer files to or from laptops, notebooks, PDA and printers. This connector supports HPSIR (115.2Kbps, 2 meters), ASK-IR (56Kbps) and Fast IR (4Mbps, 2 meters).

Install infrared module onto IrDA connector and enable infrared function from BIOS setup. Make sure to have correct orientation when you plug onto IrDA connector JSIR1.

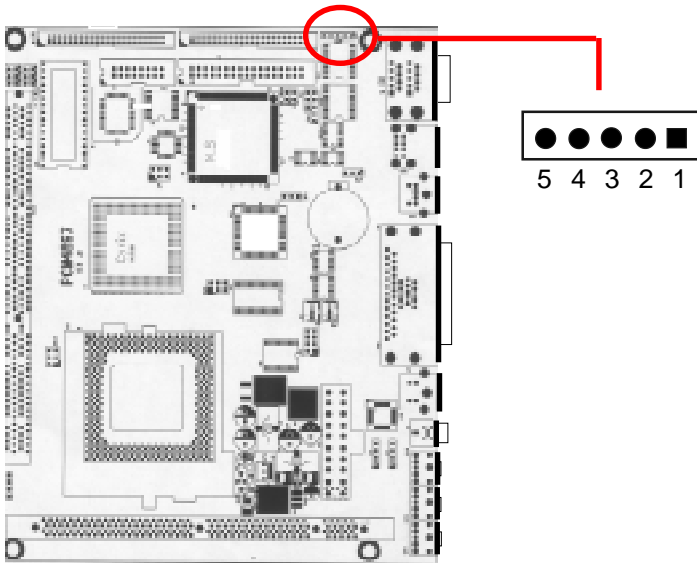

IrDA connector (JSIR1)

Pin	Signal
1	+5V
2	N.C.
3	IrRxD
4	GND
5	IrTxD

Wake up on modem connector (JWOM1)

Onboard implements special circuit to support Wake Up On Modem, both internal Modem Card and external box Modem are supported. Since internal Modem card consumes no power when system power is off, it is recommended to use internal Modem. To use internal Modem card, connect 2-pin cable from RING connector of the internal Modem card to the JWOM1 on the PCM-4897.

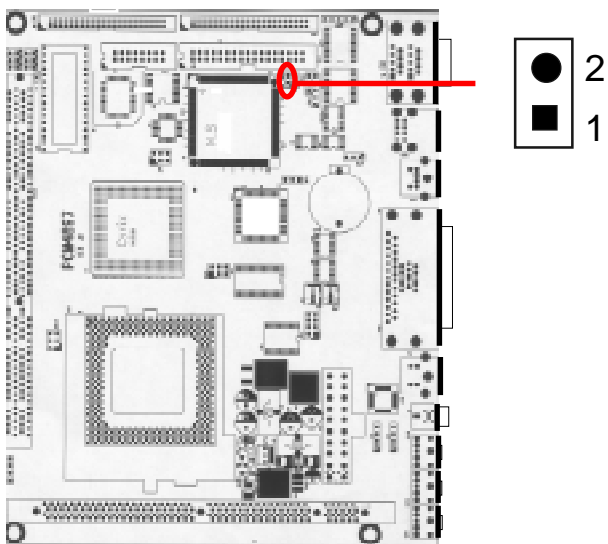

Wake up on modem connector (JWOM1)

Pin	Signal
1	GND
2	RING

LCD Backlight power connector (J1)

The PCM-4897 supports backlight power for LCD flat panels, and the backlight voltage setting please refer to JP14.

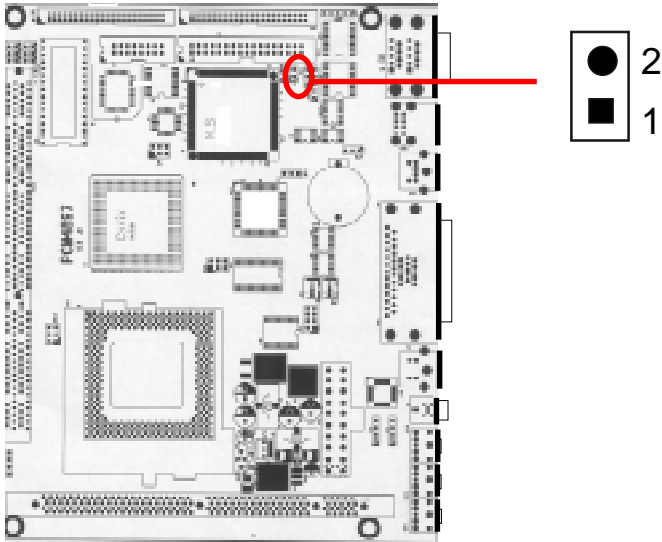

LCD Backlight power connector (J1)

Pin	Signal
1	Vcc (Voltage setting please refer to JP14)
2	GND

Composite video output connector (J2)

The PCM-4897 has a RCA Jack for composite video signal output to TV.

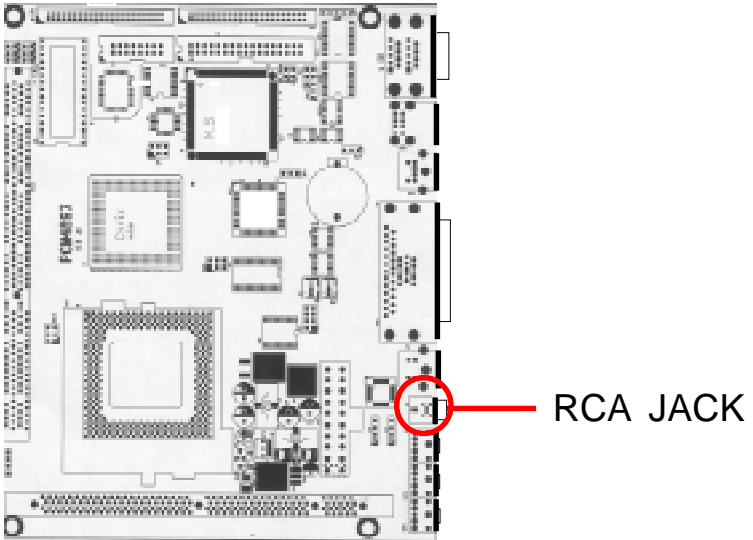

S-Video connector (J3)

The PCM-4897 has a standard S-Video Jack for video signal output to TV.

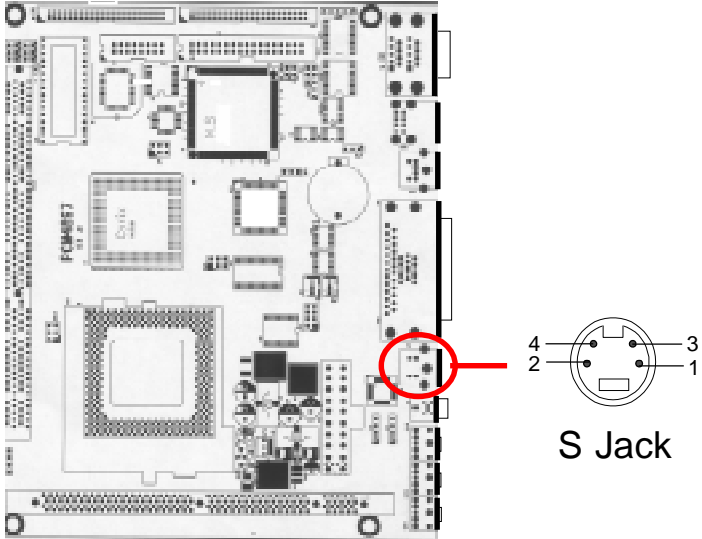

S-Video connector (J3)

Pin	Signal
1	GNDNTSC
2	GNDNTSC
3	LUMF
4	CHROMF

Internal/external buzzer select (JP1)

The CPU card has an onboard buzzer. You can disable the internal buzzer and connect an external speaker to JP1. Enabling the external speaker automatically disables the internal buzzer.

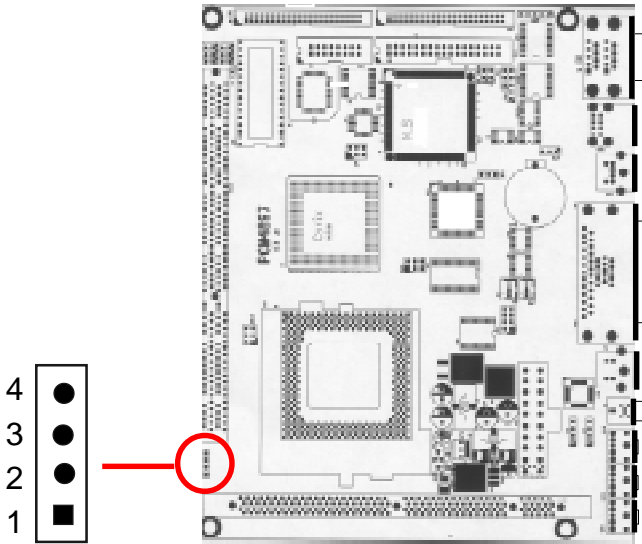

Internal/external buzzer select (JP1)

	Internal buzzer*	External speaker
JP1	4 ○ 3 ○ 2 ● 1 ■	4 ● (+) 3 ○ 2 ○ 1 ■ (-)

* default

Hardware reset (JP2)

You can connect an external switch to easily reset your computer. This switch restarts your computer as if you turned off the power then turned it back on. The following table shows the pin assignments for JP2.

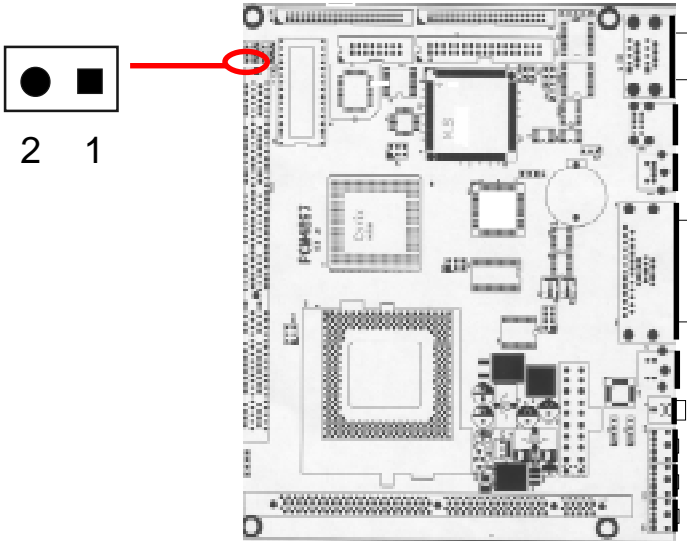

Hardware reset (JP2)	
Pin	Signal
1	Reset
2	GND

ATX Soft-Power Switch connector (JP3)

The ATX Soft-Power switch connector is a 2-pin header. Locate the power switch cable from your system. It is a 2-pin female connector. Plug this connector to the Soft-Power switch connector marked JP3.

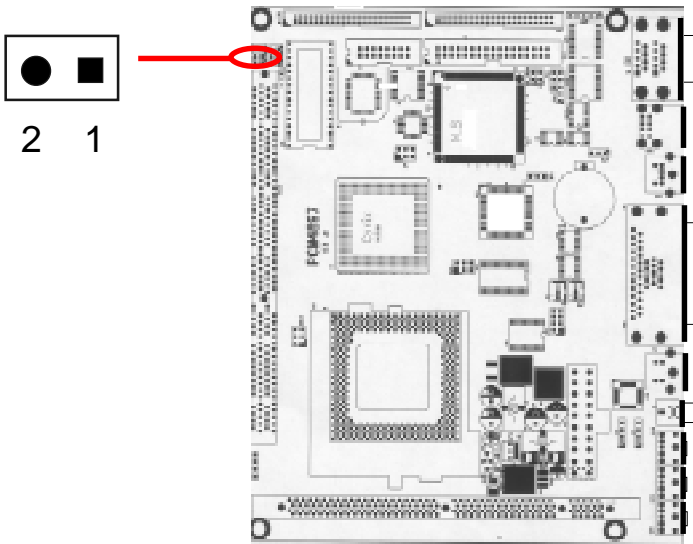

ATX Soft-Power Switch connector (JP3)

Pin	Signal
1	Power
2	GND

Power on LED (JP4)

The power LED indicates when the PCM-4897 board is on.

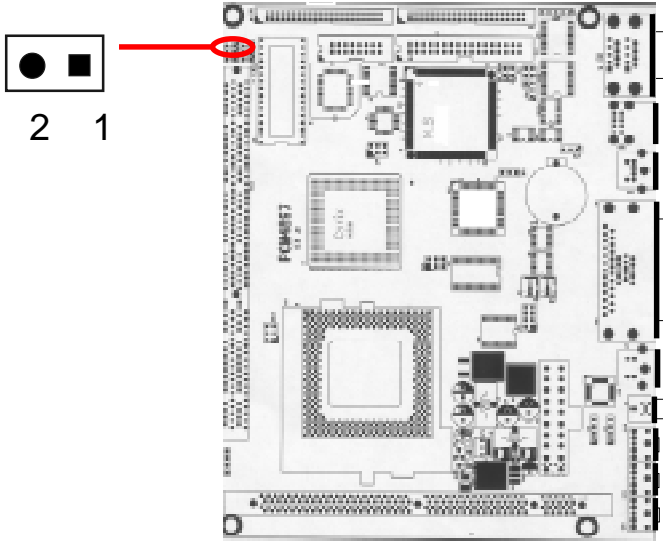

Power on LED (JP4)

Pin	Signal
1	LED (+)
2	LED (-)

Suspend switch & LED (JP5, JP6)

After the selected period of system inactivity, the board enters a hardware suspend mode, stopping the CPU clock if possible. The JP6 indicates when the PCM-4897 board enters a hardware suspend mode.

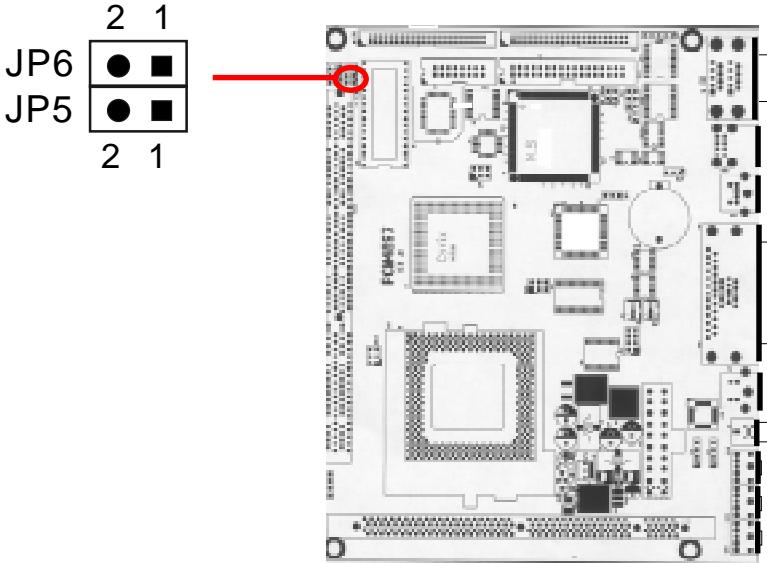

Suspend LED (JP6)

Pin	Signal
1	LED (+)
2	LED (-)

IDE LED connector (JP7)

You can connect an LED to JP7 to indicate that an IDE device is in use. The pin assignments for this connector are as follows:

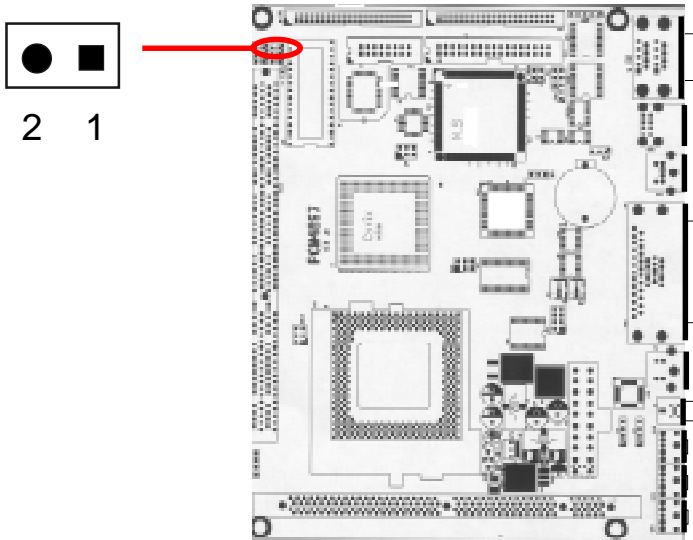

IDE LED connector (JP7)

Pin	Signal
1	Vcc (+5V)
2	- R/W IDE

DOC address select (JP8)

The DiskOnChip 2000 occupies an 8 K byte window in the upper memory address range of CC00 to DC00. You should ensure this does not conflict with any other device's memory address.

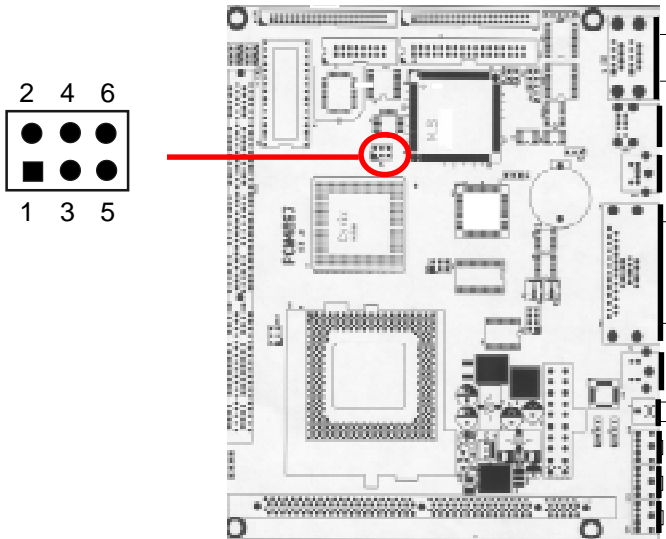

The configuration are as follows:

Address	CC00	D000	D400
	1 3 5 <input type="radio"/> <input type="radio"/> <input type="radio"/> <input type="radio"/> <input type="radio"/> <input type="radio"/> 2 4 6	1 3 5 <input type="radio"/> <input type="radio"/> <input checked="" type="radio"/> <input type="radio"/> <input type="radio"/> <input checked="" type="radio"/> 2 4 6	1 3 5 <input type="radio"/> <input checked="" type="radio"/> <input type="radio"/> <input type="radio"/> <input checked="" type="radio"/> <input type="radio"/> 2 4 6
Address	D800*	DC00	
	1 3 5 <input type="radio"/> <input checked="" type="radio"/> <input checked="" type="radio"/> <input type="radio"/> <input checked="" type="radio"/> <input checked="" type="radio"/> 2 4 6	1 3 5 <input checked="" type="radio"/> <input type="radio"/> <input type="radio"/> <input checked="" type="radio"/> <input type="radio"/> <input type="radio"/> 2 4 6	

* default

These addresses might conflict with the ROM BIOS of other peripheral boards. Please select the appropriate memory address to avoid memory conflicts.

CPU fan power connector (JP9)

Plug in the fan cable to the 3-pin fan connector onboard. The fan connector is marked JP9.

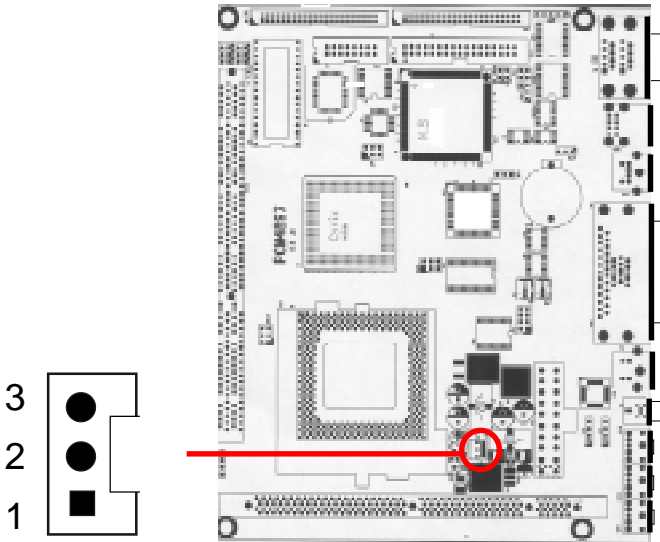

CPU fan power connector (JP9)

Pin	Signal
1	Fan speed sense
2	+12V
3	GND

Wake On LAN connector (JP11)

The PCM-4897 implements a WOL connector. To use Wake On LAN function, you need a network card that supports this features. In addition, you also need to install a network management software, such as ADM.

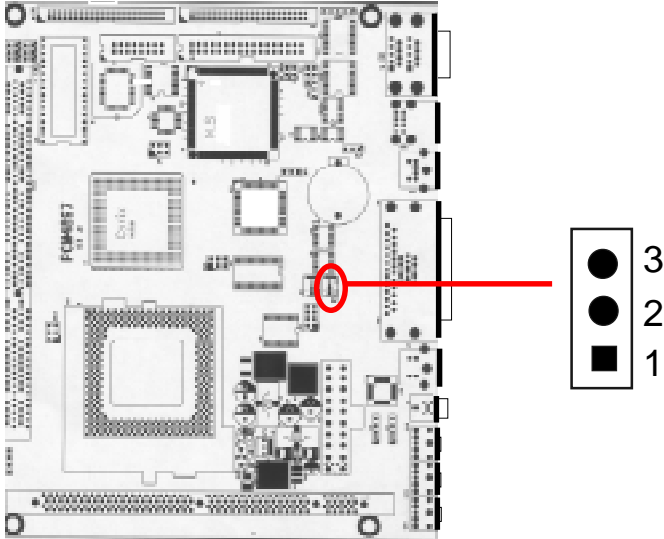

Wake on LAN connector (JP11)



Pin	Signal
1	+5V SB
2	GND
3	LID

Clear CMOS (JP13)

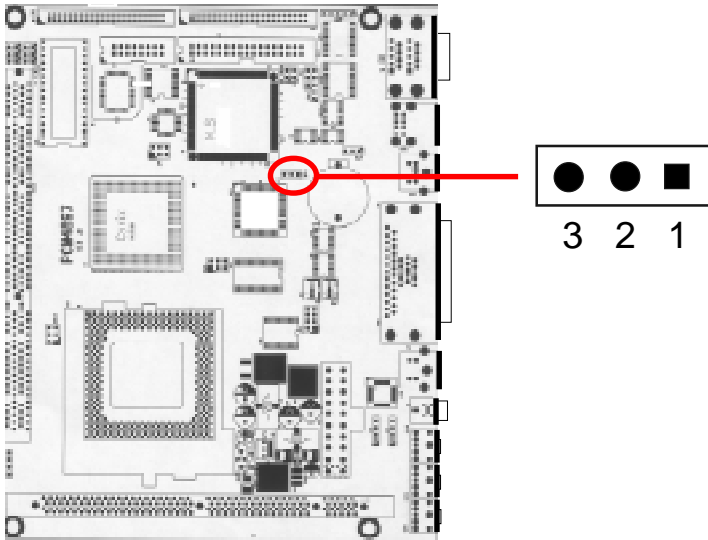
You can use JP13 to clear the CMOS data if necessary. To reset the CMOS data, set JP13 to 2-3 closed for just a few seconds, and then move the jumper back to 1-2 closed.



Clear CMOS (JP13)

	Protect*	Clear CMOS
J13	 3 2 1	 3 2 1

*default

LCD backlight voltage select (JP14)

The JP14 is a 2-pin connector which could provide the power for LCD inverter.

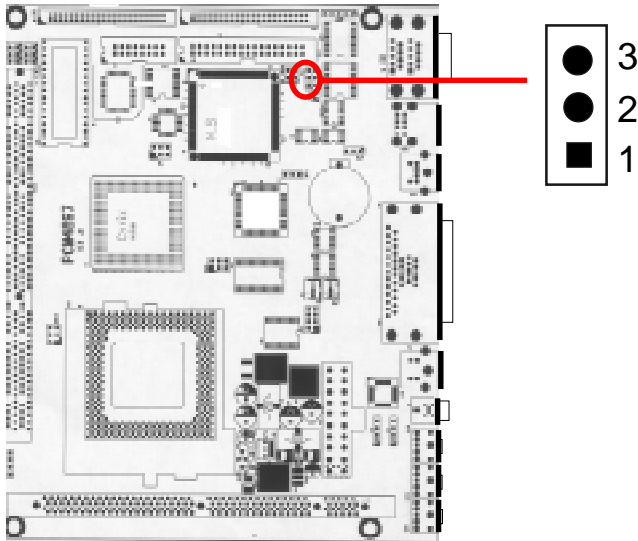

LCD backlight voltage select (JP14)		
	5V	12V*
JP14	3 ○ 2 ● 1 ●	3 ● 2 ● 1 ○

* default

Power LED and KB connector (JP15)

You can connect an LED to indicate when the CPU card is on. Pin 1 of JP15 supplies power to the LED; Pin 3 is the ground.

You can use a switch (or a lock) to disable the keyboard. In this state, the PC will not respond to any input. This is useful if you do not want anyone to change or stop a running program. Simply connect the switch between Pins 4 and 5. The pin assignments appear in the following table:

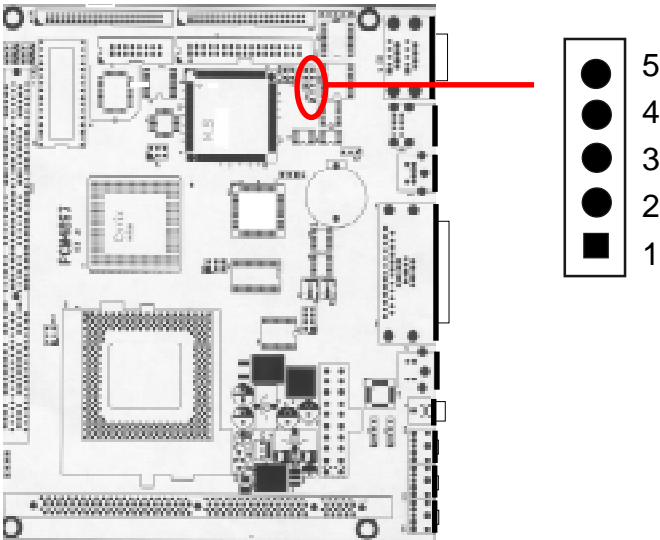

Power LED and KB lock connector (JP15)

Pin	Function
1	LED Power (+5V)
2	No Connector
3	Ground
4	Keyboard lock
5	Ground

LCD driving voltage select (JP16)

You can select the LCD connector CN4 (pin 5 and pin 6) driving voltage by setting JP16. The configurations are as follows:

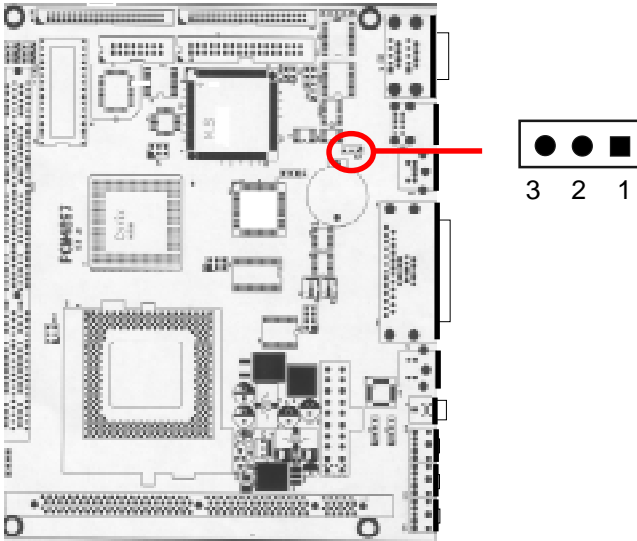

LCD driving voltage select (JP16)

	3.3V *	5 V
JP16	 3 2 1	 3 2 1

*default

IDE hard drive connector (CN1)

You can attach one or two Enhanced Integrated Device Electronics hard disk drives to the mainboard's internal controller. The mainboard's IDE controller uses a PCI local-bus interface. This advanced interface supports faster data transfer and allows the IDE hard drive to exceed 528 MB.

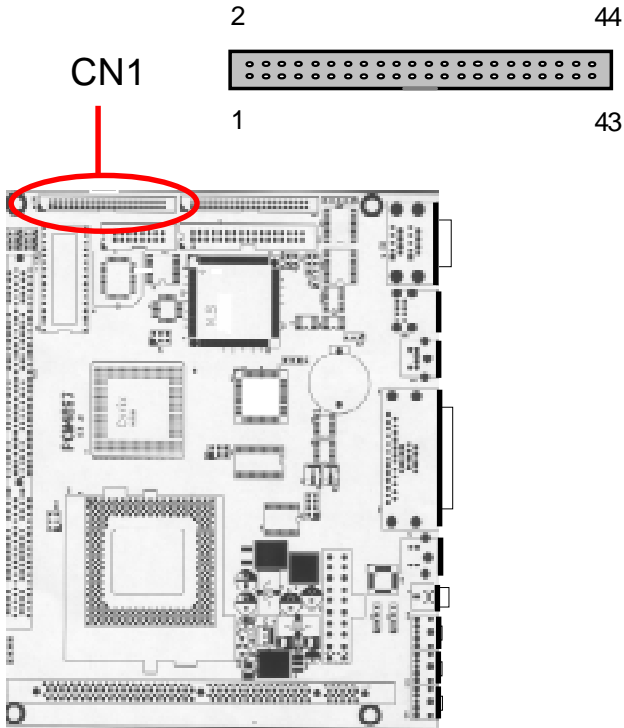

Connecting the hard drive

Connecting drives is done in a daisy-chain fashion and requires one of two cables, depending on the drive size. 1.8" and 2.5" drives need a 1 x 44-pin to 2 x 44-pin flat-cable connector. 3.5" drives use a 1 x 44-pin to 2 x 40-pin connect.

Wire number 1 on the cable is normally red or blue, and the other wires are usually gray.

1. Connect one end of the cable to CN1. Make sure that the red (or blue) wire corresponds to pin 1 on the connector, which is labeled on the board (on the right side).
2. Plug the other end of the cable to the Enhanced IDE hard drive, with pin 1 on the cable corresponding to pin 1 on the hard drives. (see your hard drive's documentation for the location of the connector).

Connect a second drive as described above.

Unlike floppy drives, IDE hard drives can connect to either end of the cable. If you install two drives, you will need to set one as the master and the other one as the slave by using jumpers on the drives. If you install just one drive, set it as the master.

IDE hard drive connector (CN1)

IDE hard drive connector (CN1)

Pin	Signal	Pin	Signal
1	IDE RESET	2	GND
3	DATA 7	4	DATA 8
5	DATA 6	6	DATA 9
7	DATA 5	8	DATA 10
9	DATA 4	10	DATA 11
11	DATA 3	12	DATA 12
13	DATA 2	14	DATA 13
15	DATA 1	16	DATA 14
17	DATA 0	18	DATA 15
19	SIGNAL GND	20	N/C
21	N/C	22	GND
23	IO WRITE	24	GND
25	IO READ	26	GND
27	IO CHANNEL READY	28	ALE
29	N/C	30	GND
31	IRQ14	32	IOCS16
33	ADDR 1	34	N/C
35	ADDR 0	36	ADDR 2
37	HARDDISK SELECT 0	38	HARDDISKSELECT 1
39	IDE ACTIVE	40	MGND
41	VCC	42	MVCC
43	GND	44	N/C

Game/Joystick/MIDI connector (CN2)

The Game/Joystick/MIDI connector (15-pin D-sub) is used to attach a joystick for game interface or to attach an external FM synthesizer for playback, mixing or recording.

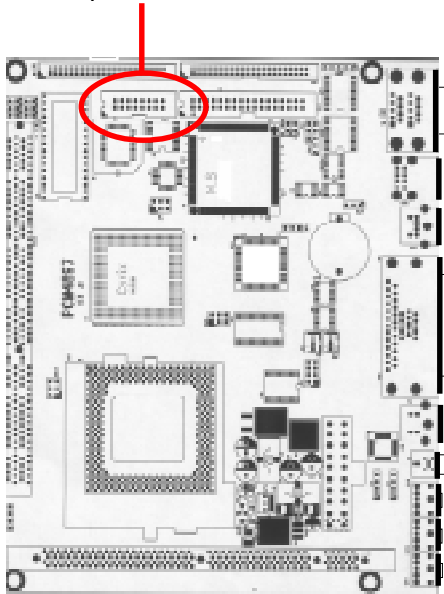
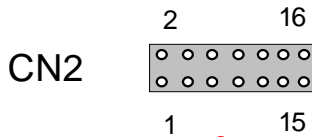

Floppy drive connector (CN3)

You can attach up to two floppy drives to the mainboard controller. You can use any combination of 5¼" (360 KB and 1.2 MB) and/or 3½" (720 KB, 1.44 MB, and 2.88 MB) drives.

A 34-pin daisy-chain drive connector cable is required for a dual-drive system. On one end of the cable is a 34-pin flat-cable connector. On the other end are two sets of floppy disk drive connectors. Each set consists of a 34-pin flat-cable connector (usually used for 3½" drives) and a printed-circuit board connector (usually used for 5¼" drives).

Wire number 1 on the cable is normally red or blue, and the other wires are usually gray.

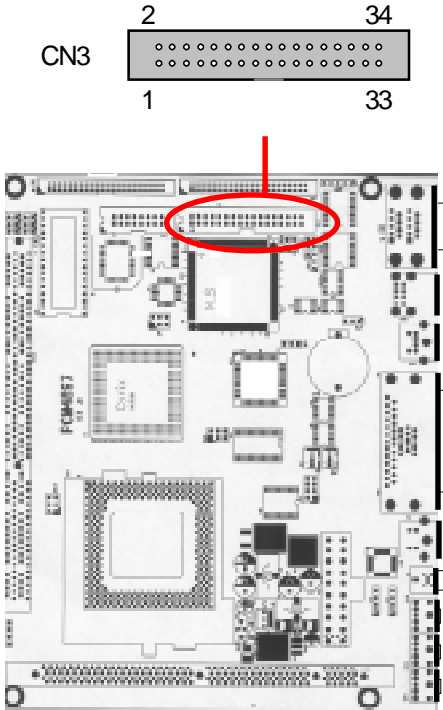

Connecting the floppy drive

1. Plug the 34-pin flat-cable connector into CN3. Make sure that the red or blue wire corresponds to pin 1 on the connector.
2. Attach the appropriate connector on the other end of the cable to the floppy drive(s). You can use only one connector in the set. The set on the end (after the twist in the cable) connects to the A: drive. The set in the middle connects to the B: drive.
3. If you are connecting a 5¼" floppy drive, line up the slot in the printed circuit board with the blocked-off part of the cable connector.

If you are connecting a 3½" floppy drive, you may have trouble determining which pin is pin number 1. Look for a number printed on the circuit board indicating pin number 1. Also, the connector on the floppy drive connector may have a slot. When the slot is up, pin number 1 should be on the right. Check the documentation that came with the drive for more information.

If you desire, connect the B: drive to the connectors in the middle of the cable as described above.

Floppy drive connector (CN3)

Floppy drive connector (CN3)

Pin	Signal	Pin	Signal
1	GND	2	DENSITY SELECT
3	GND	4	N/C
5	GND	6	DRIVE TYPE
7	GND	8	INDEX
9	GND	10	MOTOR 0
11	GND	12	DRIVE SELECT 1
13	GND	14	DRIVE SELECT 2
15	GND	16	MOTOR 1
17	GND	18	DIRECTION
19	GND	20	STEP
21	GND	22	WRITE DATA
23	GND	24	WRITE GATE
25	GND	26	TRACK 0
27	GND	28	WRITE PROTECT
29	GND	30	READ DATA
31	GND	32	HEAD DELECT
33	GND	34	DISK CHANGE

Display connectors (CN8, CN4)

The mainboard's PCI SVGA interface can drive conventional CRT displays and is capable of driving a wide range of flat panel displays, including electroluminescent (EL), gas plasma, passive LCD, and active LCD displays. The board has two connectors to support these displays, one for standard CRT VGA monitors and one for flat panel displays.

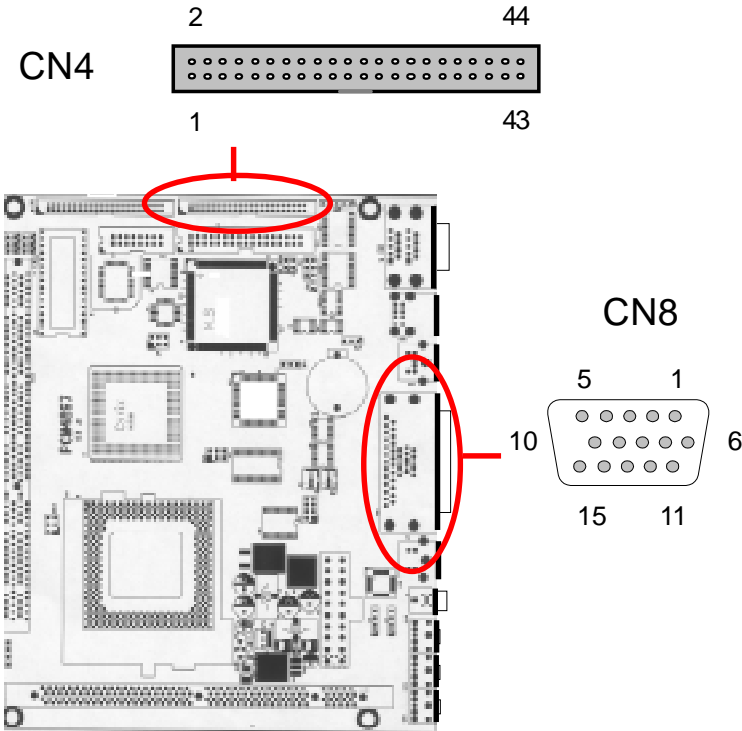

LCD connector (CN4)

CN4 is a 44-pin, dual-in-line header used for flat panel displays.

When the mainboard's power is applied, the control signal is low until just after the relevant flat panel signals are present.

Configuration of the VGA interface is done completely via the software utility. You do not have to set any jumpers.

LCD connector (CN4)			
Pin	Signal	Pin	Signal
1	+12 V _{DC}	2	+12 V _{DC}
3	GND	4	GND
5	+5 V _{DC}	6	+5 V _{DC}
7	ENA VEE	8	GND
9	P0	10	P1
11	P2	12	P3
13	P4	14	P5
15	P6	16	P7
17	P8	18	P9
19	P10	20	P11
21	P12	22	P13
23	P14	24	P15
25	P16	26	P17
27	P18	28	P19
29	P20	30	P21
31	P22	32	P23
33	GND	34	GND
35	SHF CLK	36	FLM (V SYS)
37	M	38	LP (H SYS)
39	GND	40	ENABKL
41	N/C	42	N/C
43	N/C	44	N/C

CD-ROM signal input connector (CN6)

This connector is used to connect to a CD audio cable.

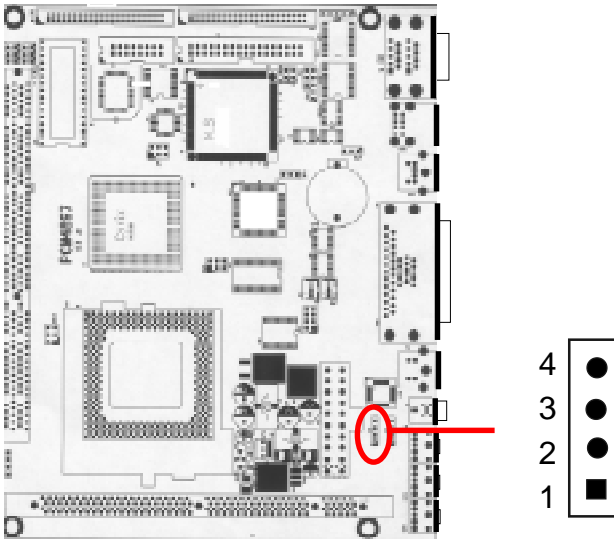

CD-ROM signal input connector (CN6)

Pin	Signal
1	CDIN_L
2	GND
3	CDIN_R
4	GND

Audio connector (for voice modem) (CN7)

This connector provide chip select signal (MCS) and IRQ input (MIRQ) pins to control external devices such as modem.

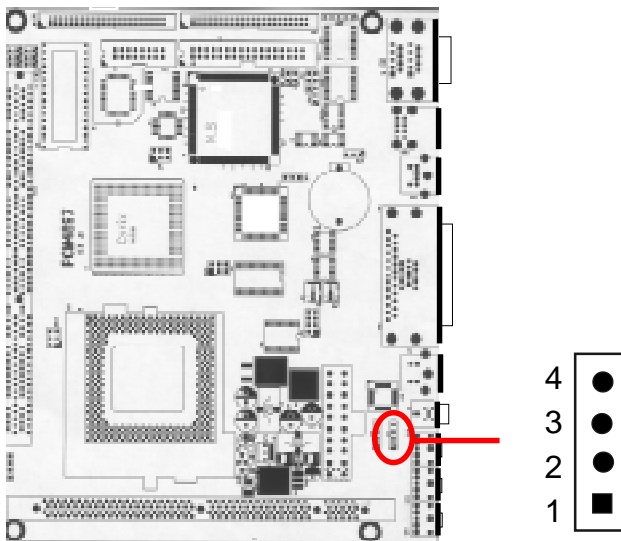

Audio connector (for voice modem) (CN7)

Pin	Signal
1	MIC (IN)
2	GND
3	GND
4	Speaker

Parallel port connector (CN9)

Normally, the parallel port is used to connect the board to a printer. The mainboard includes an onboard parallel port, accessed through CN9.

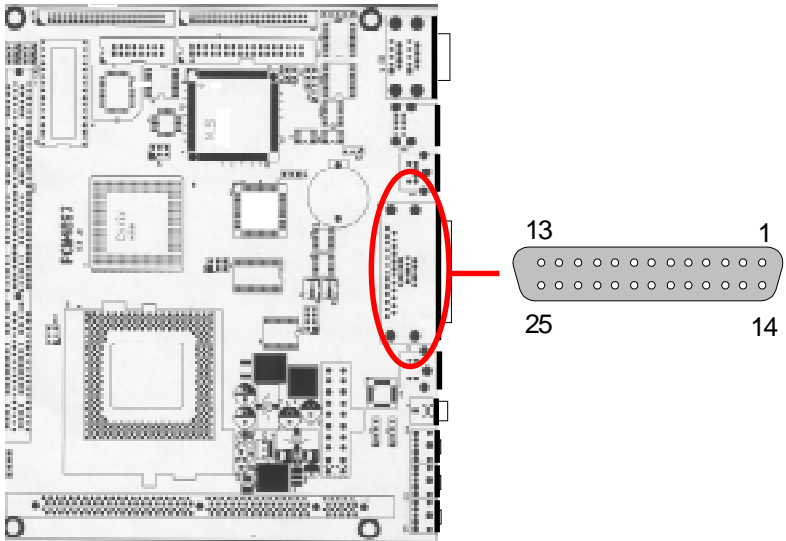

Pin assignments

Parallel (printer) Connector (CN9)

Pin	Signal	Pin	Signal
1	Strobe	2	Data 0
3	Data 1	4	Data 2
5	Data 3	6	Data 4
7	Data 5	8	Data 6
9	Data 7	10	-Acknowledge
11	Busy	12	Paper empty
13	+Select	14	-Auto feed
15	-Error	16	-Init printer
17	-Select input	18~25	GND

USB connector (CN10)

The PCM-4897 provides two USB (Universal Serial Bus) interfaces, which give complete plug and play, hot attach/detach for up to 127 external devices. The USB interfaces comply with USB specification Rev. 1.0, and can be enable/disable in the system BIOS setup.

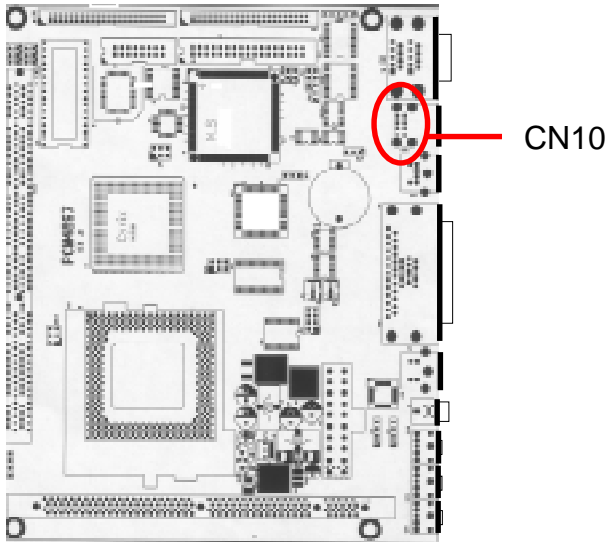

USB conector (CN10)

Pin (set1)	Signal	Pin (set2)	Signal
1	Vcc 1	1	Vcc2
2	D1F(-)	2	D2F(-)
3	D1F(+)	3	D2F(+)
4	GND	4	GND

Audio signal input connector (CN11)

The Stereo Line-In phone-jack is used to attach stereo devices such as cassette, digital audio tape, or minidisk players for paly-back, mixing, or recording.

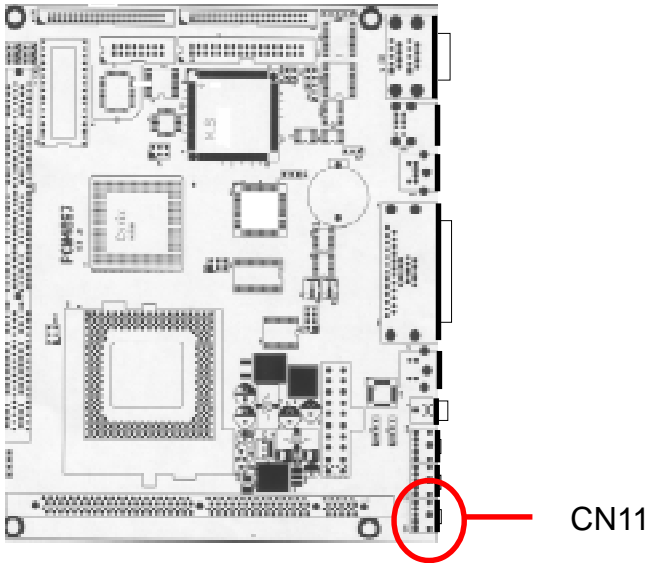

MIC signal input connector (CN13)

The Microphone In phone-jack us used to a microphone for live audio input for playback, mixing, or recording. a 20dB gain can be obtained internally. The microphone input independ will be around 1.8k ohm.

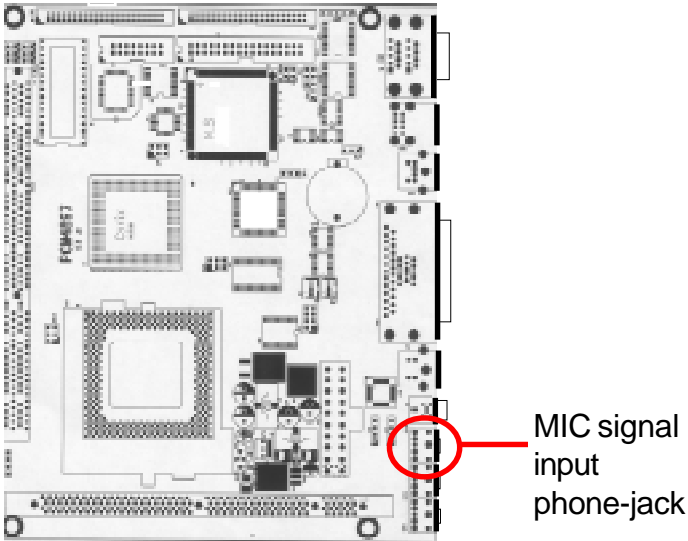

Keyboard and PS/2 mouse connector (CN14)

The PCM-4897 provides a keyboard connector which supports both a keyboard and a PS/2 style mouse. In most cases, especially in embedded applications, a keyboard is not used. The standard PC/AT BIOS will report an error or fail during power-on-self-test (POST) after a reset if the keyboard is not present. The main-board BIOS Advanced setup menu allows you to select "Present" or "Absent" under the "System Keyboard" section. This allows no-keyboard operation in embedded system applications without the system halting under POST (power-on-self-test).

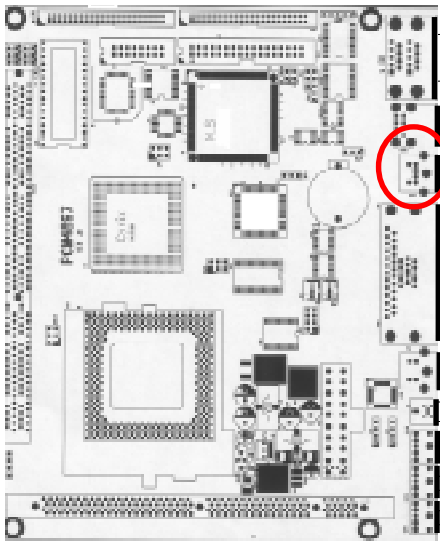

Keyboard and PS/2 mouse connector

Keyboard and PS/2 mouse connector (CN14)

Pin	Signal	Pin	Signal
1	KB data	4	+5Vcc
2	PS/2 mouse data	5	KB clock
3	GND	6	PS/2 mouse clock

Serial ports (COM1/COM2, CN15/CN16)

The PCM-4897 offers two serial ports, two RS-232. These ports allow you to connect them to serial devices (mouse, printers, etc.).

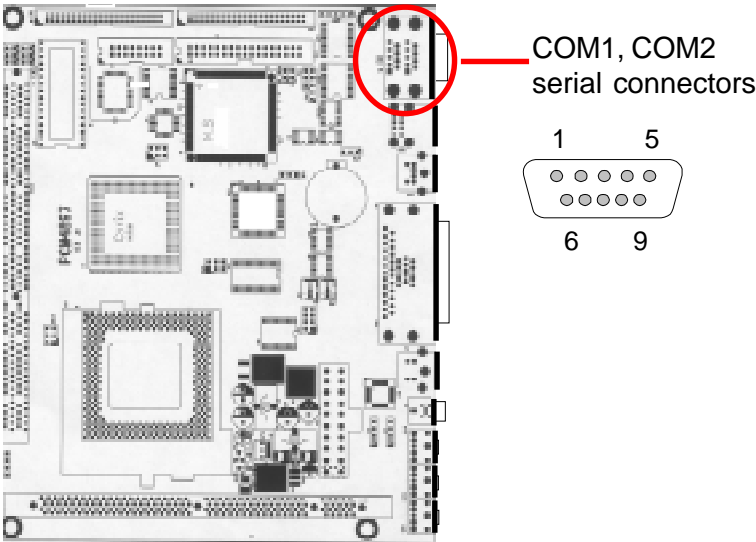

COM 1-2 RS-232 serial ports (CN15/CN16)

COM1/COM2 RS-232 serial port (CN15/CN16)

PIN	SIGNAL	PIN	SIGNAL
1	DCD	6	DSR
2	RXD	7	RTS
3	TXD	8	CTS
4	DTR	9	RIB
5	GND		

DiskOnChip socket (U4)

The DiskOnChip 2000 family of products provides a single chip solid-state flash disk in a standard 32-pin DIP package. The DiskOnChip 2000 is a solid-state disk with no moving parts, resulting in a significant reduction in power consumption and an increase in reliability. The DiskOnChip is a small plug and play Flash disk. It is easy to use. And it saves integration overhead.

The DiskOnChip 2000 family of products is available in capacities ranging from 2MB up to 144MB, unformatted. In order to manage the disk, the DiskOnChip 2000 includes the TrueFFS, M-Systems Flash File System proprietary software. The DiskOnChip 2000 package is pin-to-pin compatible with a standard 32-pin EPROM device.

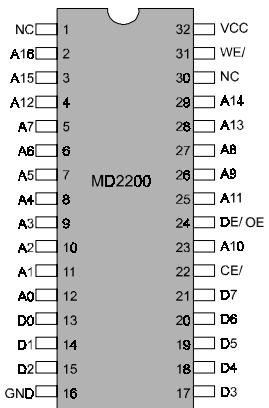

pin Name	Description	Pin Number	Direction	Note
A0-A12	Address bus	4-12,23,25-27	Inputs	
A13-A16	Address bus	2,3,28,29	Inputs	1
D0-D7	Data bus	13-15,17-21	I/O	
CE/	Chip Enable	22	Input	
OE/	Output Enable	24	Input	
WE/	Write Enable	31	Input	
NC	Not connected	1,30		2
VCC	Power	32		
GND	Ground	16		

Note 1: Pins A13 through A16 are not used by the MD2200. They are kept for socket backward compatibility with ED 1100 (DiskOnChip 1000)

Note 2: Pins 1 and 30 are not used by MD2200

DiskOnChip (DOC) 2000 Installation

When the DOC is installed correctly, a DOC will work like an HDD or an FDD. To install the DOC on the mainboard, follow the instructions below:

1. Plug the DOC into the socket. Make sure pin 1 of the DOC is aligned with pin 1 of the socket.
2. Push the DOC into the socket until it is firmly seated in the socket.

Caution: the DOC may be permanently damage if it is installed incorrectly.

3. Set the jumper for the memory address of the DOC.

Note:

The memory shadow function sometimes will create conflicts with the memory window. You should disable the memory shadow from the BIOS SETUP if the DOC cannot be accessed.

Configure DOC as a boot device

To configure a DOC as a boot drive, you should copy the operating system files onto the DOC. The following procedure is an example of the initialization process.

1. Install a DOC into your system.
2. Insert a bootable floppy disk in drive A: and boot the system.
3. At the DOS prompt, type **SYS C:** to transfer the DOS system files to the DOC (assuming the DiskOnChip is installed as drive C:). Reboot the system.
4. Go to the BIOS Setup Utility by hitting the key. Set the type of Primary Master or C: Drive as *Not Installed*.
5. Remove the floppy disk from the drive A: and leave the BIOS Setup Utility. The system should boot from the DOC.

Award BIOS Setup

This chapter describes how to configure the BIOS for the PCM-4897.

Starting setup

The Award BIOS is immediately activated when you first turn on the computer. The BIOS reads system configuration information in CMOS RAM and begins the process of checking out the system and configuring it through the power-on self test (POST).

When these preliminaries are finished, the BIOS seeks an operating system on one of the data storage devices (hard drive, floppy drive, etc.). The BIOS launches the operating system and hands control of system operations to it.

During POST, you can start the Setup program in one of two ways:

1. By pressing Del immediately after switching the system on, or
2. By pressing Del or pressing Ctrl-Alt-Esc when the following message appears briefly at the bottom of the screen during POST:

TO ENTER SETUP BEFORE BOOT PRESS DEL KEY

If the message disappears before you respond and you still wish to enter Setup, restart the system to try again by turning it OFF then ON or pressing the RESET button on the system case. You may also restart by simultaneously pressing Ctr-Alt-Del. If you do not press the keys at the correct time and the system does not boot, an error message appears and you are again asked to

PRESS F1 TO CONTINUE, DEL TO ENTER SETUP

Setup keys

These keys help you navigate in Setup:

Up arrow	Move to previous item
Down arrow	Move to next item
Left arrow	Move to the item in the left hand
Right arrow	Move to the item in the right hand
Esc	Main Menu: Quit and not save changes into CMOS RAM Other pages: Exit current page and return to Main Menu
PgDn/+	Increase the numeric value or make changes
PgDn/-	Decrease the numeric value or make changes
F1	General help, only for Status Page Setup Menu and Option Page Setup Menu
F2	Change color from total 16 colors. F2 to select color forward, Shift-F2 to select color backward
F3	Calendar, only for Status Page Setup Menu
F4	Reserved
F5	Restore the previous CMOS value from CMOS, only for Option Page Setup Menu
F6	Load the default CMOS RAM value from BIOS default table, only for Option Page Setup Menu
F7	Load the default
F8	Reserved
F9	Reserved
F10	Save all the CMOS changes, only for Main Menu

Getting help

Press F1 to pop up a small help window that describes the appropriate keys to use and the possible selections for the highlighted item. To exit the Help Window press Esc or the F1 key again.

In Case of Problems

If, after making and saving system changes with Setup, you discover that your computer no longer is able to boot, the **Award-BIOS** supports an override to the CMOS settings that resets your system to its default configuration.

You can invoke this override by immediately pressing Insert; when you restart your computer. You can restart by either using the ON/OFF switch, the RESET button or by pressing Ctrl-Alt-Delete.

The best advice is to alter only settings that you thoroughly understand. In particular, do not change settings in the Chipset screen without a good reason. The Chipset defaults have been carefully chosen by Award Software or your system manufacturer for the best performance and reliability. Even a seemingly small change to the Chipset setup may causing the system to become unstable.

Main setup Menu

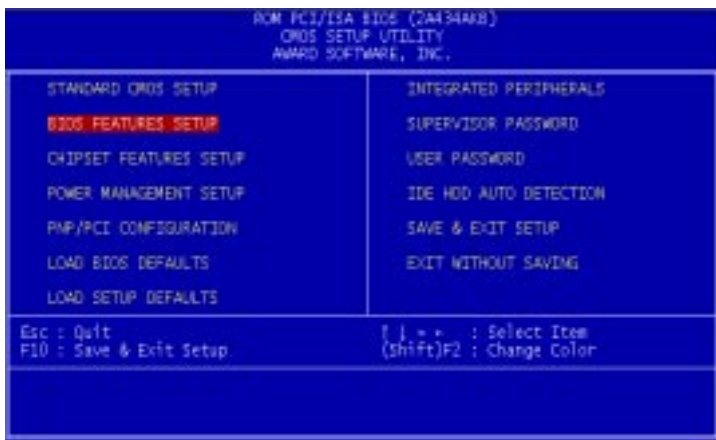

Standard CMOS	Options in the original PC AT-compatible BIOS.
BIOS Features	Award Software enhanced BIOS options.
Chipset Features	Options specific to your system chipset.
Power Management	Advanced Power Management (APM) options.
PnP/PCI Configuration	Plug and Play standard and PCI Local Bus configuration options.
Integrated Peripherals	I/O subsystems that depend on the integrated peripherals controller in your system.
Supervisor/User Password Setting	Change, set, or disable a password. In BIOS versions that allow separate user and supervisor passwords, only the supervisor password permits access to Setup. The user password generally allows only power-on access.
IDE HDD Auto Detection	Automatically detect and configure IDE hard disk parameters.

Load BIOS Defaults	BIOS defaults are factory settings for the most stable, minimal-performance system operations.
Load Setup Defaults	Setup defaults are factory settings for optimal-performance system operations.
Save & Exit Setup	Save settings in nonvolatile CMOS RAM and exit Setup.
Exit Without Save	Abandon all changes and exit Setup.

Standard CMOS setup

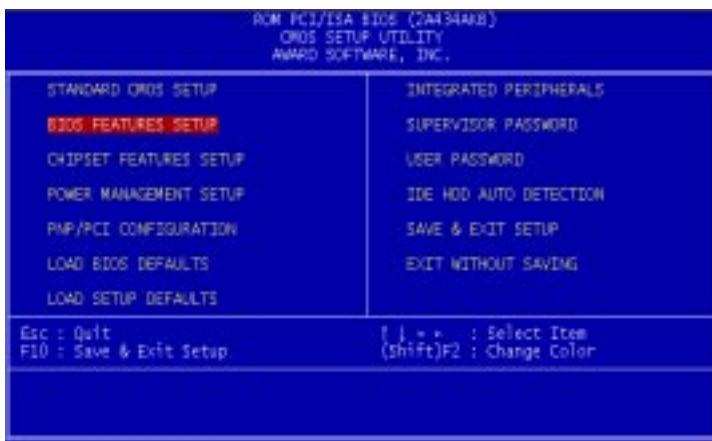

When you choose the STANDARD CMOS SETUP option from the INITIAL SETUP SCREEN menu, the screen below is displayed.



This standard setup menu allows users to configure system components such as the date, time, hard disk drive, floppy drive, display, and memory. Online help for each field can be accessed by pressing F1.

Date and Time Configuration

The BIOS determines the day of the week from the other date information. This field is for information only.

Press the left or right arrow key to move to the desired field (date, month, year). Press the PgUp/- or PgDn/+ key to increment the setting, or type the desired value into the field.

The time format is based on the 24-hour military-time clock. For example, 1 p.m. is 13:00:00. Press the left or right arrow key to move to the desired field. Press the PgUp/- or PgDn/+ key to increment the setting, or type the desired value into the field.

HARD DISKS

The BIOS supports up to four IDE drives. This section does not show information about other IDE devices, such as a CD-ROM drive, or about other hard drive types, such as SCSI drives.

***NOTE:** We recommend that you select type AUTO for all drives.*

The BIOS can automatically detect the specifications and optimal operating mode of almost all IDE hard drives. When you select type AUTO for a hard drive, the BIOS detects its specifications during POST, every time the system boots.

If you do not want to select drive type AUTO, other methods of selecting the drive type are available:

1. Match the specifications of your installed IDE hard drive(s) with the preprogrammed values for drive types 1 through 45.
2. Select USER and enter values into each drive parameter field.
3. Use the IDE HDD AUTO DETECTION function in Setup.

Here is a brief explanation of drive specifications:

- **Type:** The BIOS contains a table of pre-defined drive types. Each defined drive type has a specified number of cylinders, number of heads, write precompensation factor, landing zone, and number of sectors. Drives whose specifications do not accommodate any pre-defined type are classified as type USER.
- **Size:** Disk drive capacity (approximate). Note that this size is usually slightly greater than the size of a formatted disk given by a disk-checking program.
- **Cyls:** Number of cylinders
- **Head:** Number of heads
- **Precomp:** Write precompensation cylinder
- **Landz:** Landing zone
- **Sector:** Number of sectors
- **Mode:** Auto, Normal, Large, or LBA
 - **Auto:** The BIOS automatically determines the optimal mode.
 - **Normal:** Maximum number of cylinders, heads, and sectors supported are 1024, 16, and 63.
 - **Large:** For drives that do not support LBA and have more than 1024 cylinders.

- **LBA (Logical Block Addressing):** During drive accesses, the IDE controller transforms the data address described by sector, head, and cylinder number into a physical block address, significantly improving data transfer rates. For drives with greater than 1024 cylinders.

Drive A
Drive B

Select the correct specifications for the diskette drive(s) installed in the computer.

None	No diskette drive installed
360K, 5.25 in	5-1/4 inch PC-type standard drive; 360 kilobyte capacity
1.2M, 5.25 in	5-1/4 inch AT-type high-density drive; 1.2 megabyte capacity
720K, 3.5 in	3-1/2 inch double-sided drive; 720 kilobyte capacity
1.44M, 3.5 in	3-1/2 inch double-sided drive; 1.44 megabyte capacity
2.88M, 3.5 in	3-1/2 inch double-sided drive; 2.88 megabyte capacity

Halt On

During the power-on-self-test (POST), the computer stops if the BIOS detects a hardware error. You can tell the BIOS to ignore certain errors during POST and continue the boot-up process. These are the selections:

- **No errors:** POST does not stop for any errors.
- **All errors If:** the BIOS detects any non-fatal error, POST stops and prompts you to take corrective action.
- **All, But Keyboard:** POST does not stop for a keyboard error, but stops for all other errors
- **All, But Diskette:** POST does not stop for diskette drive errors, but stops for all other errors.
- **All, But Disk/Key:** POST does not stop for a keyboard or disk error, but stops for all other errors.

Memory

You cannot change any values in the Memory fields; they are only for your information. The fields show the total installed random access memory (RAM) and amounts allocated to base memory, extended memory, and other (high) memory. RAM is counted in kilobytes (KB: approximately one thousand bytes) and megabytes (MB: approximately one million bytes).

RAM is the computer's working memory, where the computer stores programs and data currently being used, so they are accessible to the CPU. Modern personal computers may contain up to 64 MB, 128 MB, or more.

•Base Memory

Typically 640 KB. Also called conventional memory. The DOS operating system and conventional applications use this area.

•**Extended Memory**

Above the 1-MB boundary. Early IBM personal computers could not use memory above 1 MB, but current PCs and their software can use extended memory.

•**Other Memory**

Between 640 KB and 1 MB; often called High memory. DOS may load terminate-and-stay-resident (TSR) programs, such as device drivers, in this area, to free as much conventional memory as possible for applications. Lines in your CONFIG.SYS file that start with LOADHIGH load programs into high memory.

BIOS features setup



By choosing the BIOS FEATURES SETUP option from the INITIAL SETUP SCREEN menu, the screen below is displayed.



The displayed configuration is based on the manufacturer's SETUP DEFAULTS settings.

Virus Warning

When enabled, you receive a warning message if a program (specifically, a virus) attempts to write to the boot sector or the partition table of the hard disk drive. You should then run an anti-virus program. Keep in mind that this feature protects only the boot sector, not the entire hard drive.

***NOTE:** Many disk diagnostic programs that access the boot sector table can trigger the virus warning message. If you plan to run such a program, we recommend that you first disable the virus warning.*

CPU Internal Cache/External Cache

Cache memory is additional memory that is much faster than conventional DRAM (system memory). CPUs from 486-type on up contain internal cache memory, and most, but not all, modern PCs have additional (external) cache memory. When the CPU requests data, the system transfers the requested data from the main DRAM into cache memory, for even faster access by the CPU.

The External Cache field may not appear if your system does not have external cache memory.

Quick Power On Self Test

Select Enabled to reduce the amount of time required to run the power-on-self-test (POST). A quick POST skips certain steps. We recommend that you normally disable quick POST. Better to find a problem during POST than lose data during your work.

Boot Sequence

The original IBM PCs loaded the DOS operating system from drive A (floppy disk), so IBM PC-compatible systems are designed to search for an operating system first on drive A, and then on drive C (hard disk). However, the BIOS now offers many boot sequence options.

Swap Floppy Drive

This field is effective only in systems with two floppy drives. Selecting enabled assigns physical drive B to logical drive A, and physical drive A to logical drive B.

Boot Up Floppy Seek

When Enabled, the BIOS tests (seeks) floppy drives to determine whether they have 40 or 80 tracks. Only 360-KB floppy drives have 40 tracks; drives with 720 KB, 1.2 MB, and 1.44 MB capacity all have 80 tracks. Because very few modern PCs have 40-track floppy drives, we recommend that you set this field to Disabled to save time.

Boot Up NumLock Status

Toggle between On or Off to control the state of the NumLock key when the system boots. When toggled On, the numeric keypad generates numbers instead of controlling cursor operations.

Gate A20 Option

Gate A20 refers to the way the system addresses memory above 1 MB (extended memory). When set to Fast, the system chipset controls Gate A20. When set to Normal, a pin in the keyboard controller controls Gate A20. Setting Gate A20 to Fast improves system speed, particularly with OS/2 and Windows.

Security Option

If you have set a password, select whether the password is required every time the System boots, or only when you enter Setup.

Shadow

Software that resides in a read-only memory (ROM) chip on a device is called firmware. The AwardBIOS permits shadowing of firmware such as the system BIOS, video BIOS, and similar operating instructions that come with some expansion peripherals, such as, for example, a SCSI adaptor.

Shadowing copies firmware from ROM into system RAM, where the CPU can read it through the 16-bit or 32-bit DRAM bus. Firmware not shadowed must be read by the system through the 8-bit X-bus. Shadowing improves the performance of the system BIOS and similar ROM firmware for expansion peripherals, but it also reduces the amount of high memory (640 KB to 1 MB) available for loading device drivers, etc.

Enable shadowing into each section of memory separately. Many system designers hardwire shadowing of the system BIOS and eliminate a System BIOS Shadow option.

Video BIOS shadows into memory area C0000-C7FFF. The remaining areas shown on the BIOS Features Setup screen may be occupied by other expansion card firmware. If an expansion peripheral in your system contains ROM-based firmware, you need to know the address range the ROM occupies to shadow it into the correct area of RAM.

CHIPSET features setup



By choosing the CHIPSET FEATURES SETUP option from the INITIAL SETUP SCREEN menu, the screen below is displayed.



The displayed configuration is based on the manufacturer's SETUP DEFAULTS settings.

This section allows you to configure the system based on the specific features of the installed chipset. This chipset manages bus speeds and access to system memory resources, such as SDRAM. It also coordinates communications between the conventional ISA bus and the PCI bus. It must be stated that these items should never need to be altered. The default settings have been chosen because they provide the best operating conditions for your system. The only time you might consider making any changes would be if you discovered that data was being lost while using your system.

Because of the complexity and technical nature of some of the options, not all of the options are described here.

SDRAM CAS Latency Time

When synchronous DRAM is installed, you can control the number of CLKs between when the SDRAMs sample a read command and when the controller samples read data from the SDRAMs. Do not reset this field from the default value specified by the system designer.

8/16 Bit I/O Recovery Time

The I/O recovery mechanism adds bus clock cycles between PCI-originated I/O cycles to the ISA bus. This delay takes place because the PCI bus is so much faster than the ISA bus.

These two fields let you add recovery time (in bus clock cycles) for 16-bit and 8-bit I/O.

Power management setup



By choosing the POWER MANAGEMENT option from the INITIAL SETUP SCREEN menu, the screen below is displayed.



Power Management

This option allows you to select the type (or degree) of power saving for Doze, Standby, and Suspend modes.

This table describes each power management mode:

Max Saving	Maximum power savings. Only Available for SL CPUs. Inactivity period is 1 minute in each mode.
User Define	Set each mode individually. Select time-out periods in the section for each mode, below.
Min Saving	Minimum power savings. Inactivity period is 1 hour in each mode (except the hard drive).

Doze Mode

After the selected period of system inactivity, the CPU clock throttles to a small percentage of its duty cycle — between 10 percent and 25 percent for most chipsets. All other devices still operate at full speed.

Suspend Mode

After the selected period of system inactivity, the chipset enters a hardware suspend mode, stopping the CPU clock and possibly causing other system devices to enter power management modes.

HDD Power Down

After the selected period of drive inactivity, any system IDE devices compatible with the ATA-2 specification or later power manage themselves, putting themselves into an idle state after the specified timeout and then waking themselves up when accessed.

MODEM Use IRQ

Name the interrupt request (IRQ) line assigned to the modem (if any) on your system. Activity of the selected IRQ always awakens the system.

Throttle Duty Cycle

When the system enters Doze mode, the CPU clock runs only part of the time. You may select the percent of time that the clock runs.

Soft-Off by PWR-BTTN

When you select Instant Off or Delay 4 Sec., turning the system off with the on/off button places the system in a very low-power-usage state, either immediately or after 4 seconds, with only enough circuitry receiving power to detect power button activity or Resume by Ring activity.

PNP/PCI configuration setup



By choosing the PNP/PCI CONFIGURATION SETUP option from the initial SETUP SCREEN menu, the screen below is displayed.



PNP OS Installed

Select Yes if the system operating environment is Plug-and-Play aware (e.g., Windows 95).

Resources Controlled By

The Plug and Play AwardBIOS can automatically configure all the boot and Plug and Play-compatible devices. If you select Auto, all the interrupt request (IRQ) and DMA assignment fields disappear, as the BIOS automatically assigns them.

Reset Configuration Data

Normally, you leave this field Disabled. Select Enabled to reset Extended System Configuration Data (ESCD) when you exit Setup if you have installed a new add-on and the system reconfiguration has caused such a serious conflict that the operating system cannot boot.

PCI IRQ Activated by

Leave the IRQ trigger set at Level unless the PCI device assigned to the interrupt specifies Edge-triggered interrupts.

Load BIOS defaults/Load setup defaults

LOAD BIOS DEFAULTS loads the default system values directly from ROM. The BIOS DEFAULTS provides the most stable settings, though they do not provide optimal performance. LOAD SETUP DEFAULTS, on the other hand, provides for maximum system performance. If the stored record created by the setup utility becomes corrupted (and therefore unusable), BIOS defaults will load automatically when you turn the PCM-4897 on.

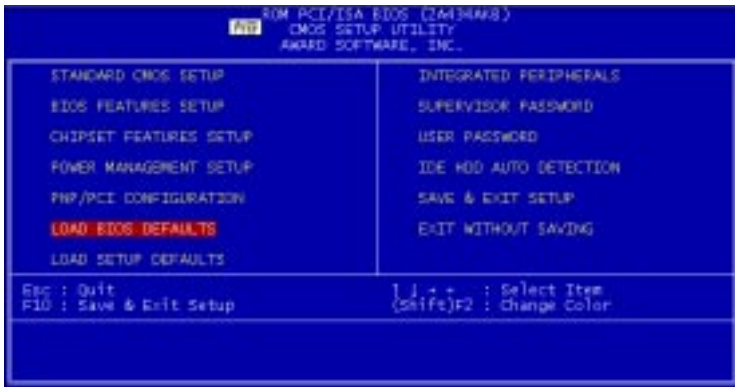

Integrated peripherals setup



By choosing the INTEGRATED PERIPHERALS option from the initial SETUP SCREEN menu, the screen below is displayed.



IDE HDD Block Mode

Select Enabled only if your hard drives support block mode.

IDE PIO Modes (Primary Master/Slave)

The four IDE PIO (Programmed Input/Output) fields let you set a PIO mode (0-4) for each of up to four IDE devices that the internal PCI IDE interface supports. Modes 0 through 4 provide successively increased performance. In Auto mode, the system automatically determines the best mode for each device.

IDE Primary Master/Slave UDMA

UDMA (Ultra DMA) is a DMA data transfer protocol that utilizes ATA commands and the ATA bus to allow DMA commands to transfer data at a maximum burst rate of 33 MB/s. When you select Auto in the four IDE UDMA fields (for each of up to four IDE devices that the internal PCI IDE interface supports), the system automatically determines the optimal data transfer rate for each IDE device.

**RING POWER ON Controller
Onboard FDC Controller**

Select Enabled if your system has a floppy disk controller (FDC) installed on the system board and you wish to use it. If you install an add-in FDC or the system has no floppy drive, select Disabled in this field.

Onboard Serial Ports (1, 2)

Select a logical COM port address for the first and second serial ports.

ECP Mode Use DMA

Select a DMA channel for the port.

Multiple Maitor Support

Choose priority of the VGA function from PCI slot or onboard.

Video Memory size

Share memory from DIMM, from 1.5MB to 4MB.

TV Output mode

Support NTSC or PAL system.

Flat Panel Resolution

Onboard support TFT LCD as below.

640x480

800x600

1024x768

Supervisor/User password setting

You can set either SUPERVISOR or USER PASSWORD, or both of them. The difference between the two is that the supervisor password allows unrestricted access to enter and change the options of the setup menus, while the user password only allows entry to the program, but not modify options.



When you select this function, a message appears at the center of the screen:

ENTER PASSWORD:

Type the password, up to eight characters, and press Enter. Typing a password clears any previously entered password from CMOS memory.

Now the message changes:

CONFIRM PASSWORD:

Again, type the password and press Enter.

To abort the process at any time, press Esc.

In the Security Option item in the BIOS Features Setup screen, select System or Setup:

System Enter a password each time the system boots and when ever you enter Setup.

Setup Enter a password when ever you enter Setup.

***NOTE:** To clear the password, simply press Enter when asked to enter a password. Then the password function is disabled.*

IDE HDD auto detection

The IDE HDD AUTO DETECTION utility can automatically detect the IDE hard disk installed in your system. You can use it to self-detect and/or correct the hard disk type configuration. You need to repeat the setup for each of the IDE combinations:



Save & exit setup

If you select this option and press <ENTER>, the values entered in the setup utility will be recorded in the chipset's CMOS memory. The microprocessor will check this every time you turn your system on and compare this to what it finds as it checks the system. This record is required for the system to operate.

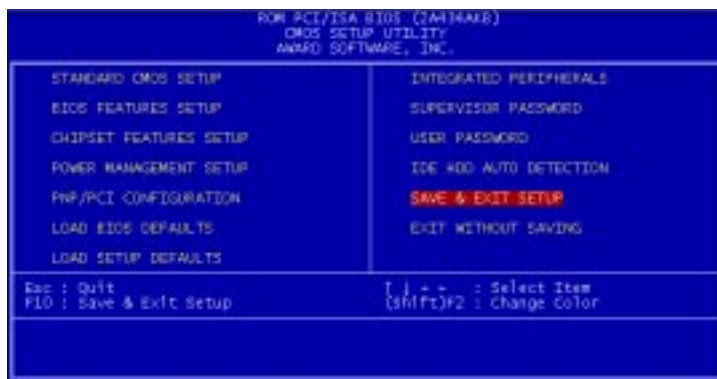

Exit without saving

If you select this option and press <ENTER>, the values entered in the setup utility will be recorded in the chipset's CMOS memory. The microprocessor will check this every time you turn your system on and compare this to what it finds as it checks the system. This record is required for the system to operate.



Flat Panel/CRT Controller Display Drivers and Utilities

This chapter provides information about:

- Driver types and installation

Software drivers

This chapter describes the operation and installation of the display drivers supplied on the *Supporting CD-ROM* that are shipped with your product.

The onboard VGA adapter is based on the Cx5530 VGA Flat Panel/CRT controller. This controller offers a large set of extended functions and higher resolutions. If you intend to use your VGA adapter in standard VGA modes only, you do not need to install any of these drivers. Since your VGA adapter is fully compatible, it does not require any special drivers to operate in standard modes.

The purpose of the enclosed software drivers is to take advantage of the extended features of the CHIPS VGA Flat Panel/CRT controller.

Hardware configuration

Some of the high-resolution drivers provided in this package will work only in certain system configurations. If a driver does not display correctly, try the following:

1. Change the display controller to CRT-only mode, rather than flat panel or simultaneous display mode. Some high-resolution drivers will display correctly only in CRT mode.
2. If a high-resolution mode is not supported on your system, try using a lower-resolution mode. For example, 1024 x 768 mode will not work on some systems, but 800 x 600 mode is supported on most.

Necessary prerequisites

The instructions in this manual assume that you understand elementary concepts of MS-DOS and the IBM Personal Computer. Before you attempt to install any driver from the *Supporting CD-ROM*, you should:

- Know how to copy files from a CD-ROM to a directory on the hard disk
- Understand the MS-DOS directory structure

If you are uncertain about any of these concepts, please refer to the DOS or OS/2 user reference guides for more information *before* you proceed with the installation.

Before you begin

Make sure you know the version of the application for which you are installing drivers. The *Supporting CD-ROM* contain drivers for several versions of certain applications. For your driver to operate properly, you must install the driver for your version of the application program.

Windows® 95

These drivers are designed to work with Microsoft® Windows®. You just install these drivers through the Windows® operating system.

Driver installation

1. Install Windows® 95 as you normally would for a VGA display. Click the **Start** button, go to **Settings** and click on **Control Panel**. Choose the **Display** icon and double click on the icon. In the *Display Properties* window, show as figure 1:



figure 1

Click the setting button, then click the Advanced Properties icon into the *Advanced Display properties* windows, show as figure2:

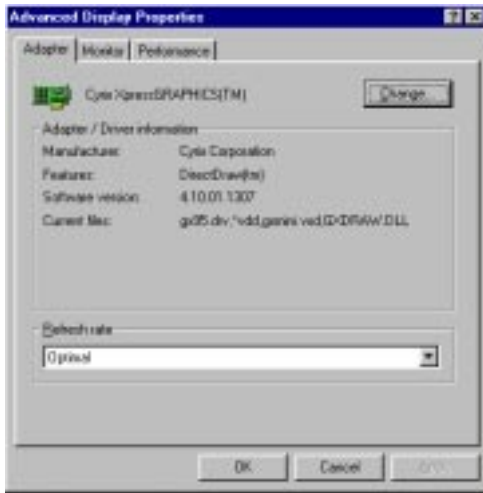

figure 2

click on **Change Display Type**. In the *Change Display Type* window, click on the **Change** button under Adapter Type into the select Device window show as figure 3: This will bring up the *Select Device* window.



figure 3

2. Place the *Supporting CD-ROM* in your CD-ROM drive.

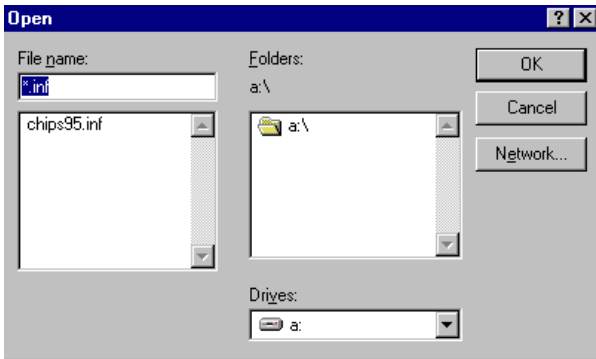

figure 4

In the *Select Device* window, click on **Have Disk**, Select **Browse**, and find the Win95 driver "chips95.inf" in the *Supporting CD-ROM*:

cd-rom: \CD ROM\model name\driver\vga driver
 \win95\GX95.inf and then click OK.

"**cd-rom**" : the drive letter of your CD-ROM drive

"**model name**" : the model number of your product

The name of the *Cyrix Xpress GRAPHICS(TM)* " driver will appear highlighted in the *Models* list boxflow as figure. Click OK to start the driver installation show as figure 5:

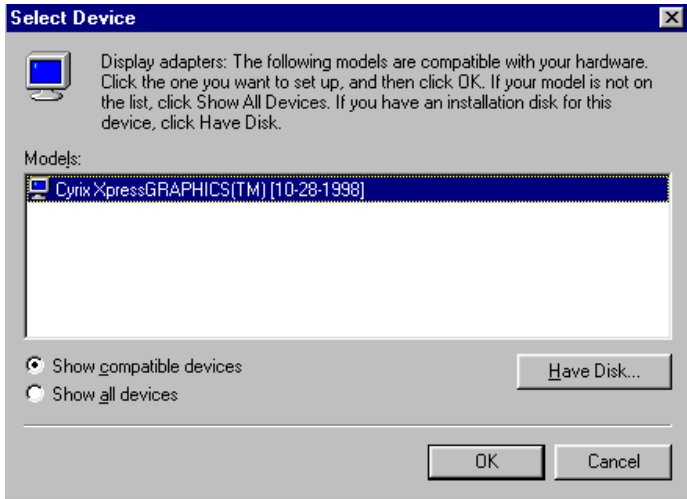

figure 5

3. Once the installation is complete, the *Advanced display Properties* window will reappear. Show as figure 6:



figure 6

Click on close to close the window. Then the *Display Properties* window will reappear. Show as figure 7:



figure 7

Click on **Apply**. Restart the system for the new settings to take effect, show as figure 8:

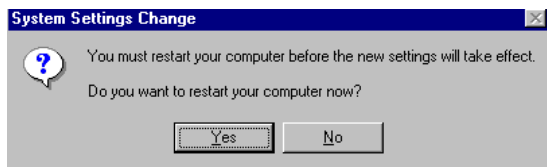

figure 8

Windows® 3.1

These drivers are designed to work with Microsoft Windows Version 3.1. You should install these drivers through Windows.

Driver installation

1. Install Windows as you normally would for a VGA display. Run Windows to make sure that it is working correctly.
2. Place the *Supporting CD-ROM* into your CD-ROM drive. In Windows Program Manager, choose *File* from the Options Menu. Then from the pull-down menu, choose *Run*. At the Command Line prompt, type.

cd-rom: \CD ROM*model name*\driver\vga driver\win31\setup.exe

Press the <ENTER> key or click OK to begin the installation.

"*cd-rom*" : the drive letter of your CD-ROM drive

"*model name*" : the model number of your product

At this point the setup program locates the directory where Windows is installed. **For proper operation, the drivers must be installed in the Windows subdirectory.**

3. Press <ENTER> to complete the installation. Once completed, you can find the icon Chips CPL under the Control Panel. The icon allows you to select and load the installed drivers.

OS/2

These drivers are designed to function with the OS/2 Version 4.0, 3.0 and 2.11 operating systems.

To install this driver, do the following steps:

1. Open an OS/2 full screen or windowed session.
2. Place the *Supporting CD-ROM* into your CD-ROM drive.
3. At the OS/2 command prompt, type the following commands to copy the files to the OS/2 drive:

```
cd-rom:\CD ROM\model name\driver\vga driver\os2\setup.cmd
```

"**cd-rom**" : the drive letter of your CD-ROM drive

"**model name**" : the model number of your product

When the Setup Program is completed, you will need to perform a shutdown and then restart the system in order for changes to take effect.

A log of the information output during the install can be found in <root>:\OS2\INSTALL\DISPLAY.LOG

4. After restarting the system, perform the following steps:
 1. Open the OS/2 System folder.
 2. Open the System Setup folder.
 3. Open the Display Driver Install Object.

This step will execute the Display Driver Installation (DSPINSTL) utility program to finish installation of the new drivers.

4. When the Display Driver Install window appears, select Primary Display and then select OK.
5. When the Primary Display Driver List window appears, select "Cyrix Xpress GRAPHICS" from the list of adapter types, then select OK or install the video driver.

6. When the installation is complete, you will need to shut down and then restart the system for the changes to take effect. Make sure to remove the installation diskette before restarting the system.

Windows® NT 3.51

These drivers are designed to work with Microsoft® Windows®.

Driver installation

1. Install Windows® NT 3.51 as you normally would for a **VGA** display. Click the **Star** button, go to **Settings** and click on **Control Panel** icon. Then choose the **Display** and double click on the icon. In the **Display Properties** window, click the **Setting** button, then click the **Display Type** button into the **Display Type** windows, then click on **Change** button from the **Adapter Type** icon. And click on **Have Disk** button in the change display window.
2. Place the *Supporting CD-ROM* into your CD-ROM drive.

and type:

```
cd-rom: \CD ROM\model name\drive\vga drive\  
win98 nt\windows.nt\nt35\Oemsetup.inf
```

"**cd-rom**" : the drive letter of your CD-ROM drive

"**model name**" : the model number of your product

Select the adapter "GX95" and click OK.

Click on Install to install the selected driver. Once the installation is complete, shut down and restart the system.

Windows® NT 4.0

Driver installation

1. Install Windows[®] NT 4.0 as you normally would for a **VGA** display. Click the **Star** button, go to **Settings** and click on **Control Panel** icon. Then choose the **Display** and double click on the icon. In the **Display Properties** window, click the **Setting** button, then click the **Display Type** button into the **Display Type** windows, then click on **Change** button from the **Adapter Type** icon. And click on **Have Disk** button in the change display window.

2. Place the *Supporting CD-ROM* into your CD-ROM drive. In the *Select Device* window, click on **Have Disk**, select "**Browse**" and find the NT 4.0 driver from:

cd-rom : \CD ROM\model name\dirver\vga driver\
win98 nt\windows.nt\nt40\Oemsetup.inf

"**cd-rom**" : the drive letter of your CD-ROM drive

"**model name**" : the model number of your product

and then click OK. The name of the *CCryix Xpress GRAPHICS(TM)* driver will appear highlighted in the Modules list box. Select Gx5530 and Click **OK**. Click **OK** to start the driver installation.

3. Once the installation is complete, the *Change Display Type* window will reappear. Click on close to close the window. Then the *Display Properties* window will reappear. Click on **Apply**. Restart the system for the new settings to take effect.

Audio Setup

This PCM-4897 is equipped with an audio interface that records and playback CD-quality audio. This chapter provides instructions for installing the software drivers on the included CDROM.

Introduction

The PCM-4897 on board audio interface provides high-quality stereo sound and FM music synthesis (ESFM). The audio interface can record, compress, and play back voice, sound, and music with built-in mixer control.

The PCM-4897 on board audio interface also supports the Plug and Play (PnP) standard and provides PnP configuration for the audio, FM, and MPU-401 logical devices. It is compatible with Sound Blaster voice and music functions. The ESFM synthesizer is register compatible with the OPL3 and has extended capabilities.

Setting Up in Windows 95

The supporting CD-ROM contains the Windows 95 drivers for Cx5530. Please see the online help for details.



Note: Refer to your Windows 95 manual or online help for any questions on Windows 95.

Installing the drivers under Window95

1. Click "*Start*" --> "*Setting*"--> "*Control Panel*" to open the Control Panel window.

Double click the "*Add New Hardware*" icon.

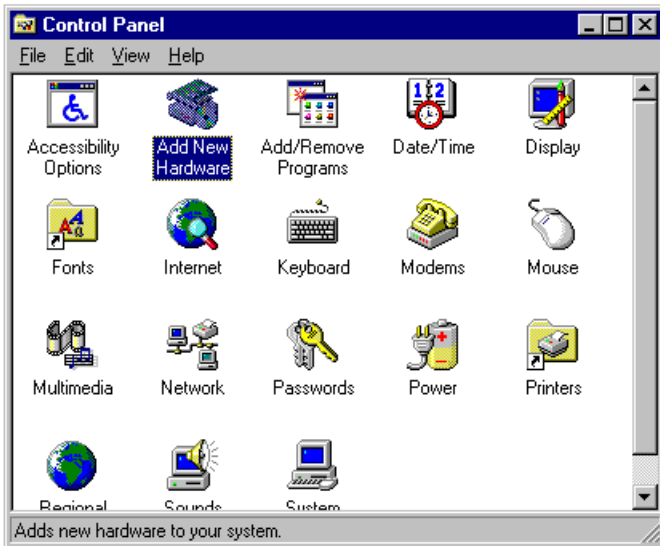

2. Click the "*Next*" button on the "*Add New Hardware Wizard*" window.



3. Choose "**No**" for manual installing new hardware. Then click the "**Next**" button.



4. Find and click to choose the sound icon. Then click the "*Next*" button.



5. Click the "***Have Disk...***" button.



- Specify the drive letter and path for the Supporting CD-ROM as follow then click the "**OK**" button.

cd-rom: \ CD-ROM \ *model name* \ driver \ audio

"**cd-rom:**": the drive letter of your CD-ROM drive

"**model name**": the model number of your product

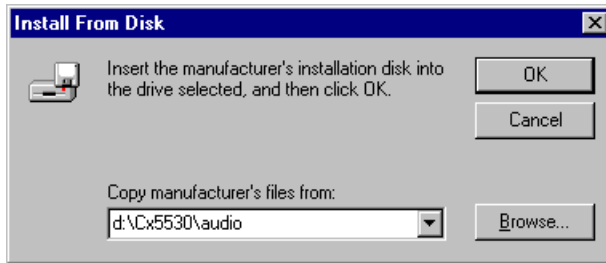

- Click the "**OK**" button to choose the Cyrix Xpress AUDIO 16-bit Sound drivers.

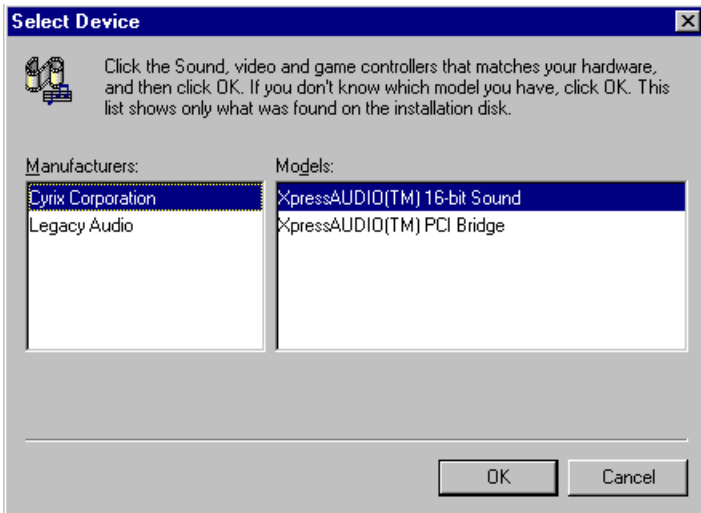

8. Click the "**Finish**" button and follow instructions to finish the installation.



9. Windows 95 will ask you to restart your computer to finish the set up. Click the "**Yes**" button to reboot your system so the new drivers can be activated.

