Copyright and Warranty Notice

The information in this document is subject to change without notice and does not represent a commitment on part of the vendor, who assumes no liability or responsibility for any errors that may appear in this manual.

No warranty or representation, either expressed or implied, is made with respect to the quality, accuracy or fitness for any particular part of this document. In no event shall the manufacturer be liable for direct, indirect, special, incidental or consequential damages arising from any defect or error in this manual or product.

Product names appearing in this manual are for identification purpose only and trademarks and product names or brand names appearing in this document are property of their respective owners.

This document contains materials protected under International Copyright Laws. All rights reserved. No part of this manual may be reproduced, transmitted or transcribed without the expressed written permission of the manufacturer and authors of this manual.

If you do not properly set the motherboard settings causing the motherboard to malfunction or fail, we cannot guarantee any responsibility.

BE6-II Motherboard User's Manual

Table of Contents

CHAPTER 1. INTRODUCTION OF BE6-II FEATURES	1-1
1-1. FEATURES OF THIS MOTHERBOARD	1-1
1-2. SPECIFICATIONS	1-2
1-3. LAYOUT DIAGRAM	1-5
1-4. THE SYSTEM BLOCK DIAGRAM	1-6
CHAPTER 2. INSTALLING THE MOTHERBOARD	2-1
2-1. INSTALLING THE MOTHERBOARD TO THE CHASSIS	2-2
2-2. INSTALLATION OF THE PENTIUM® II/III, CELERON™ CPU	2-3
2-3. INSTALLING SYSTEM MEMORY	2-3
2-4. CONNECTORS, HEADERS AND SWITCHES	2-6
2-5. CPU FREQUENCY SETTINGS	2-19
CHAPTER 3. INTRODUCTION OF THE BIOS	3-1
3-1. SOFTMENU™ III	3-4
3-2. STANDARD CMOS FEATURES SETUP MENU	3-9
3-3. ADVANCED BIOS FEATURES SETUP MENU	3-14
3-4. ADVANCED CHIPSET FEATURES SETUP MENU	3-20
3-5. INTEGRATED PERIPHERALS	3-24
3-6. POWER MANAGEMENT SETUP MENU	3-29
3-7. PNP/PCI CONFIGURATIONS	3-37
3-8. PC HEALTH STATUS	3-42
3-9. LOAD FAIL-SAFE DEFAULTS	3-43
3-10. LOAD OPTIMIZED DEFAULTS	3-43
3-11. SET PASSWORD	3-44
3-12. SAVE & EXIT SETUP	3-45
3-13. EXIT WITHOUT SAVING	3-46

-
-
- APPENDIX A BIOS FLASHING USER INSTRUCTIONS**
 - APPENDIX B INSTALLING THE HIGHPOINT XSTORE PRO UTILITY**
 - APPENDIX C HARDWARE MONITORING FUNCTION (INSTALLING THE WINBOND HARDWARE DOCTOR UTILITY)**
 - APPENDIX D INSTALLING THE DRIVER FOR ULTRA ATA/66**
 - APPENDIX E THE THERMAL CABLE**
 - APPENDIX F TROUBLESHOOTING (NEED ASSISTANCE?)**
-
-

Chapter 1. Introduction of BE6-II Features

1-1.Features of This Motherboard

The motherboard is designed for a new generation CPUs. It supports the Intel SLOT1 structure (Pentium® II/III and Celeron™ processors), up to 768MB of memory, super I/O, and Green PC functions. The motherboard provides high performance for server systems and meets the requirements for desktop system for multimedia in the future.

The BE6-II has the HPT366 Ultra ATA/66 Chipset built-in. This means, the BE6-II will support Ultra ATA/66 IDE devices. Ultra ATA/66 is the new standard for IDE devices. It enhances existing Ultra ATA/33 technology by increasing both performance and data integrity. This new high-speed interface doubles the Ultra ATA/33 burst data transfer rate to 66.6 Mbytes/sec. The result is maximum disc performance using the current PCI local bus environment. Another benefit is, you can connect another four IDE devices in your system either Ultra ATA/33 IDE devices or Ultra ATA/66 IDE devices. You will have more flexibility to expand your computer system.

The BE6-II has built-in hardware monitoring functions (you can refer to *Appendix C* for detailed information), they can monitor and protect your computer insuring a safe computing environment. The BE6-II also supports the PS/2 keyboard, PS/2 mouse, password and hot key wake up features (you can refer to section 3-5 for detailed information), letting you easily wake up your system by these devices. The motherboard can provide high performance for workstations and meets the requirements for desktop systems for multimedia in the future.

The BE6-II uses the ABIT newest BIOS technology – CPU Soft Menu™ III. The ABIT CPU Soft Menu™ III technology not only lets you configure CPU settings easily but also lets you have a greater choice of CPU FSB clock settings. It provides 120 different CPU FSB clock settings. From 84 to 200 MHz, the increment for CPU FSB clock settings is 1Mhz by 1MHz (you can refer to section 3-1 for detailed information).

Sets You Free From the Y2K Threat

The potential threat of Year 2000 (Y2K) problems are making everyone very nervous. The Y2K issue applies to almost any device, firmware, or software that operates on or with year based dates. This problem is caused by a design flaw in the **Real Time Clock (RTC)** unit. The RTC only changes the last two digits of the year code, but not the century information. As a result, when it comes to 12:00 AM January 1, 2000 the RTC will switch from December 31 11:59 PM 1999 to 12:00 AM January 1 1900.

Y2K compliance deals with the date change over from 31 December 1999 to 1 January 2000, and with recording and reporting of all dates from the RTC including leap year dates. This motherboard is free from the Y2K problem because its BIOS are Y2K compliant.

Please Note

If the operating system or application software cannot handle Year 2000 dates, you will still be facing the Y2K threat because it is not a hardware problem that relates to the motherboard itself. According to Award BIOS, it is BIOS source code released after 31 May 1995 complies with all known Y2K issues; however, it may still fail the 2000.exe test. Award has modified its BIOS source code to accommodate the requirements of 2000.exe. Award BIOS source code issued later than 18 November 1996 passes the NTSL 2000.exe test program.

1-2. Specifications

1. CPU

- Supports Intel® Pentium® III 450 ~ 700 MHz Processor cartridge.
- Supports Intel® Pentium® II 233 ~ 450 MHz Processor cartridge.
- Supports Intel® Celeron™ 266 ~ 533MHz processors (Based on 66MHz PPGA package)
- Supports 66 and 100MHz CPU external clock speeds

2. Chipset

- Intel® 440BX chipset (82443BX and 82371EB)
- HPT366 Ultra DMA66 IDE controller supports four Ultra DMA66 devices
- Supports Ultra DMA/33 IDE protocol
- Supports Advanced Configuration and Power Management Interface (ACPI)
- Accelerated Graphics Port connector supports AGP 1x and 2x mode (Sideband) 3.3V device

3. Memory (System Memory)

- Three 168-pin DIMM sockets support SDRAM modules
- Supports up to 768MB MAX. (8, 16, 32, 64, 128, 256 MB SDRAM)
- Supports ECC

4. System BIOS

- CPU SOFT MENU™ III, can easily set the processor parameters
- AWARD 6.0 Version BIOS

- Supports Plug-and-Play (PnP)
- Supports Advanced Configuration Power Interface (ACPI)
- Supports Desktop Management Interface (DMI)
- Year 2000 compliant

5. Multi I/O Functions

- 2x Channels of Bus Master IDE Ports supporting up to four Ultra DMA 33/66 devices
- 2x Channels of Bus Master IDE Ports supporting up to four Ultra DMA 33 devices
- PS/2 Keyboard and PS/2 Mouse Connectors
- 1x Floppy Port (up to 2.88MB)
- 1x Parallel Port (EPP/ECP)
- 2x Serial Ports
- 2x USB Connectors

6. Miscellaneous

- ATX form factor
- One AGP slot, five PCI slots and one ISA slot
- Supports PS/2 keyboard, PS/2 mouse, password and hot key wake-up functions
- Built-in Wake on LAN header
- Built-in IrDA TX/RX header
- Built-in SB-Link™ header
- Built-in Wake On Ring header
- Built-in two SMBus headers
- Hardware monitoring : Included fan speed, voltages, CPU and system environment temperature
- One Thermal Sensor Cable included
- Board size: 305 * 200mm

- * Supports Wake On LAN, Keyboard or Mouse, but your ATX power supply 5V standby power must be able to provide at least a 720mA current capacity. Otherwise, the functions may not work normally.
- * PCI slot 5 and HPT 366 IDE controller use the same bus master control signals.
- * PCI slot 3 shares IRQ signals with the HPT366 IDE controller (Ultra ATA/66). The driver for HPT 366 IDE controller supports IRQ sharing with other PCI devices. But if you install a PCI card that doesn't allow IRQ sharing with other devices into PCI slot 3, you may encounter some problems. Furthermore, if your Operating System doesn't allow peripheral devices to share IRQ signals with each other-- Windows NT for example, you can't install a PCI card into PCI slot 3.
- * PCI slot 5 shares IRQ signals with the PCI slot 2
- * HPT 366 IDE controller is designed to support high-speed mass storage. Thus we don't suggest you connect non-disk devices that use ATA/ATAPI interfaces, such as CD-ROM to HPT 366 IDE connector (IDE3&IDE4).
- * Above 66MHz/100MHz bus speeds are supported but not guaranteed due to the PCI and chipset specifications.
- * Sound Blaster™ is a registered trademark of Creative Technology Ltd. in the United States and certain other countries. Sound Blaster - LINK™ and SB-LINK™ are trademarks of Creative Technology Ltd.
- * Specifications and information contained in this manual are subject to change without notice.

Note

All brand names and trademarks are the property of their respective owners.

1-3. Layout Diagram

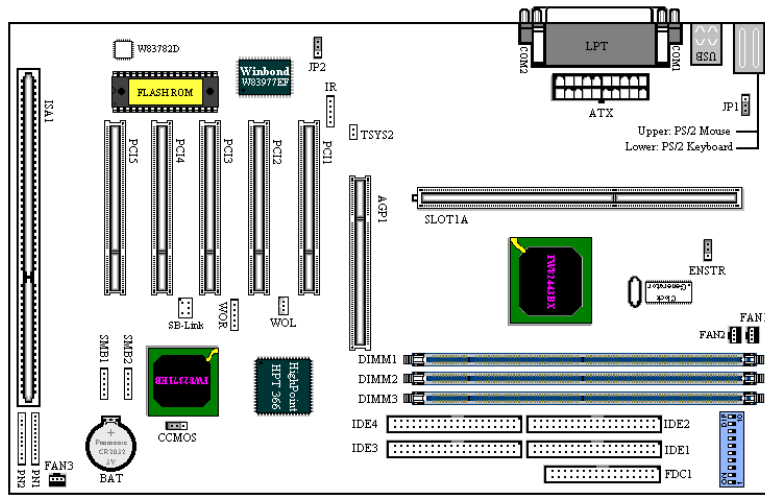

Figure 1-2. Motherboard component location

1-4. The System Block Diagram

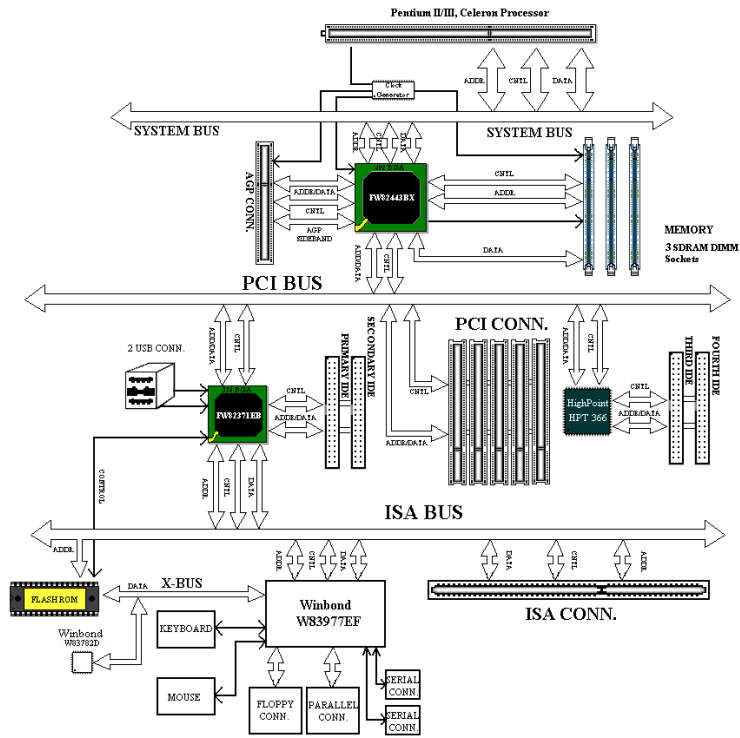

Figure 1-3. System diagram of the 440BX chipset

Chapter 2. Installing the Motherboard

This BE6-II motherboard not only provides all standard equipment for classic personal computers, but also provides great flexibility for meeting future upgrade demands. This chapter will introduce step by step all the standard equipment and will also present, as completely as possible, future upgrade capabilities. This motherboard is able to support all Intel® Pentium® II/III processors and Intel® Celeron® processor now on the market. (For details, see specifications in Chapter 1.)

This chapter is organized according the following features:

- 2-1 Installing the Motherboard to the Chassis
- 2-2 Installation of the Pentium® II/III, Celeron® CPU
- 2-3 Installing System Memory
- 2-4 Connectors, Headers and Switches
- 2-5 CPU Frequency Settings



Before Proceeding with the Installation



Before you install or unplug any connectors or add-on cards, please remember to turn the ATX power supply switch off (fully turn the +5V standby power off), or take the power cord off. Otherwise, you may cause the motherboard components or add-on cards to malfunction or be damaged.



User Friendly Instructions

Our objective is to enable the novice computer user to perform the installation by himself. We have attempted to write this document in a very clear, concise and descriptive manner to help overcome any obstacles you may face during installation. Please read our instructions carefully and follow them step-by-step.

2-1. Installing the Motherboard to the Chassis

Most computer chassis will have a base on which there will be many mounting holes that allows the motherboard to be securely attached and at the same time, prevents short circuits. There are two ways to attach the motherboard to the base of chassis:

- with studs
- or with spacers

Please refer to the figure 2-1 that shows the studs and spacers, they may have several types, but all look like the figures below:

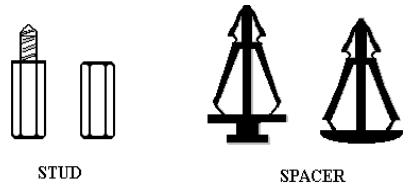

Figure 2-1. The outline of stub and spacer

In principle, the best way to attach the motherboard is with studs, and only if you are unable to do this should you attach the board with spacers. Take a careful look at the motherboard and you will see many mounting holes on it. Line these holes up with the mounting holes on the base. If the holes line up, and there are screw holes this means you can attach the motherboard with studs. If the holes line up and there are only slots, this means you can only attach the motherboard with spacers. Take the tip of the spacers and insert them into the slots. After doing this to all the slots, you can slide the motherboard into position aligned with the slots. After the motherboard has been positioned, check to make sure everything is OK before putting the casing back on.

Figure 2-2 shows you the way to affix the motherboard using studs or spacers:

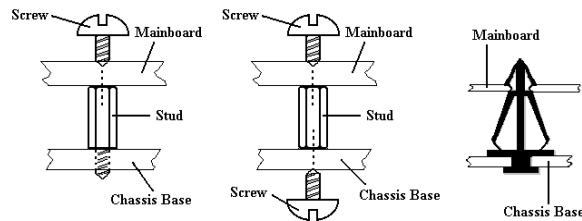

Figure 2-2. The way we fixed the motherboard

Note

If the motherboard has mounting holes, but they don't line up with the holes on the base and there are no slots to attach the spacers, don't worry, you can still attach the spacers to the mounting holes. Just cut the bottom portion of spacers (the spacer may be a little hard to cut off, so be careful of your hands). In this way you can still attach the motherboard to the base without worrying about short circuits. Sometimes you may need to use the plastic springs to isolate the screw from the motherboard PCB surface, because the circuit wire may be near by the hole. Be careful, don't let the screw contact any printed circuit wire or parts on the PCB that are near the fixing hole, otherwise it may damage the board or cause board malfunctioning.

2-2. Installation of the Pentium® II/III, Celeron™ CPU

The installation method for the CPU is printed on the package of the retention mechanism that comes with the motherboard. You can refer to it while you install the CPU. This motherboard also supports the Celeron™ PPGA processor. If you want to install the Celeron™ PPGA processor, you have to use an additional adapter that allows you to use a Celeron™ PPGA processor in a slot 1 board. For this ABIT makes the SlotKET® adapter.

Note:

- Installing a heat sink and cooling fan is necessary for proper heat dissipation from your CPU. Failing to install these items may result in overheating and damage of your CPU.
- Please refer to your boxed processor installation or other documentation attached with your CPU for detailed installing instructions.

2-3. Installing System Memory

This motherboard provides three 168-pin DIMM sites for memory expansion. The DIMM sockets support 1Mx64 (8MB), 2Mx64 (16MB), 4Mx64 (32MB), 8Mx64 (64MB), 16Mx64 (128MB), and 32Mx64 (256MB) or double sided DIMM modules. Minimum memory size is 8MB and maximum memory size is 768MB SDRAM. There are three Memory module sockets on the system board. (Total six banks)

In order to create a memory array, certain rules must be followed. The following set of rules allows for optimum configurations.

- The memory array is 64 or 72 bits wide. (depending on with or without parity)
- Those modules can be populated in any order.
- Supports single and double density DIMMS.

Table 2-1. Valid Memory Configurations

Bank	Memory Module	Total Memory
Bank 0, 1 (DIMM1)	8MB, 16MB, 32MB, 64MB, 128MB, 256MB	8MB ~ 256MB
Bank 2, 3 (DIMM2)	8MB, 16MB, 32MB, 64MB, 128MB, 256MB	8MB ~ 256MB
Bank 4, 5 (DIMM3)	8MB, 16MB, 32MB, 64MB, 128MB, 256MB	8MB ~ 256MB
Total System Memory		8MB ~ 768MB

Generally, installing SDRAM modules to your motherboard is an easy thing to do. You can refer to figure 2-3 to see what a 168-pin PC100 SDRAM module looks like.



Figure 2-3 PC100 Module and Component Mark

Unlike installing SIMMs, DIMMs may be "snapped" directly into the socket. Note: Certain DIMM sockets have minor physical differences. If your module doesn't seem to fit, please do not force it into the socket as you may damaged your memory module or DIMM socket.

The following procedure will show you how to install a DIMM module into a DIMM socket.

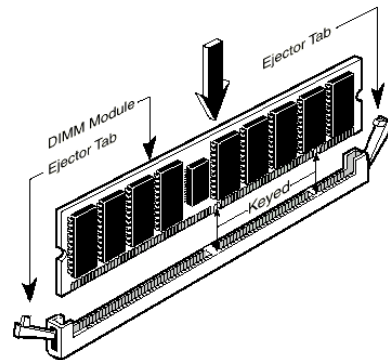

Figure 2-4. Memory module installation

Unlike installing SIMMs, DIMMs may be "snapped" directly into the socket. Note: Certain DIMM sockets have minor physical differences. If your module

Step 1. Before you install the memory module, please place the computer power switch in the *off* position and disconnect the AC power cord from your computer.

Step 2. Remove the computer's chassis cover.

Step 3. Before touching any electronic components, make sure you first touch an unpainted, grounded metal object to discharge any static electricity stored on your clothing or body.

- Step 4.** Locate your computer's 168-pin memory expansion DIMM socket.
- Step 5.** Insert the DIMM module into the expansion socket as shown in the illustration. Note how the module is keyed to the socket. You can refer to figure 2-4 for the details. ***This insures the DIMM module will be plugged into the socket in one way only.*** Firmly press the DIMM module into the DIMM socket, making certain the module is completely seated in the DIMM socket.
- Step 6.** Once the DIMM module has been installed, the installation is complete and the computer's cover can be replaced. Or you can continue to install other devices and add-on cards that are mentioned in the following section.

Note

When you install a DIMM module fully into the DIMM socket, the eject tab should be locked into the DIMM module very firmly and fit into its indentation on the both sides.

2-4. Connectors, Headers and Switches

Inside the case of any computer several cables and plugs have to be connected. These cables and plugs are usually connected one-by-one to connectors located on the motherboard. You need to carefully pay attention to any connection orientation the cables may have and, if any, notice the position of the first pin of the connector. In the explanations that follow, we will describe the significance of the first pin.

We will show you all connectors, headers and switches here, and tell you how to connect them. Please pay attention and read the whole section for necessary information before attempting to finish all of the hardware installation inside the computer chassis.

Figure 2-5 shows you all of the connectors and headers that we'll discuss in the next section, you can use this diagram to visually locate each connector and header we describe.

All connectors, headers and switches mentioned here, will depend on your system configuration. Some features you may (or may not) have and need to connect or configure depending on the peripheral. If your system doesn't have such add-on cards or switches you can ignore some special feature connectors.

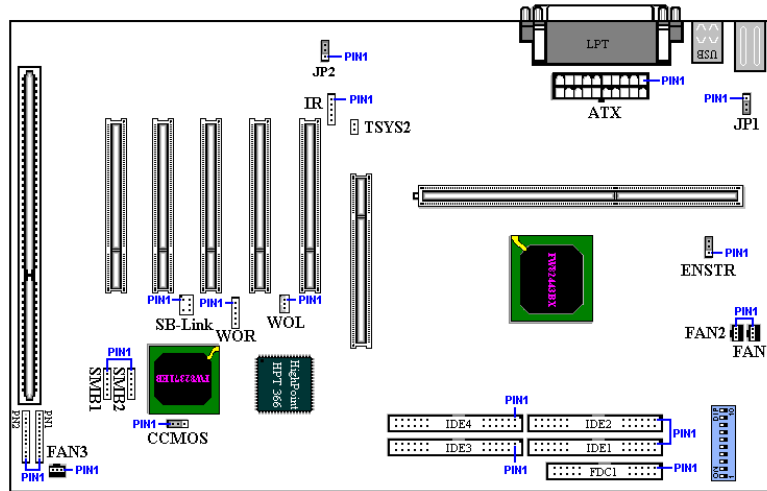
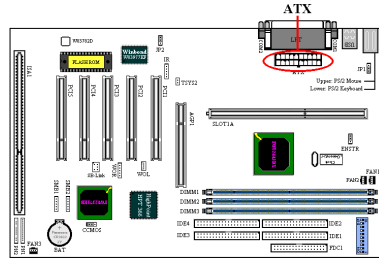

Figure 2-5. All Connectors and Headers for the BE6-II

First, Let's see the headers that BE6-II uses, and what their functions are.

ATX: ATX Power Input Connector**Caution**

If the power supply connectors are not properly attached to the ATX power supply, the power supply or add-on cards may be damaged.



Attach the connector from the power supply to the ATX connector here. Remember you have to push the connector from the ATX power supply firmly to the end with the ATX connector, insuring that you have a good connection.

Note: Watch the pin position and the orientation

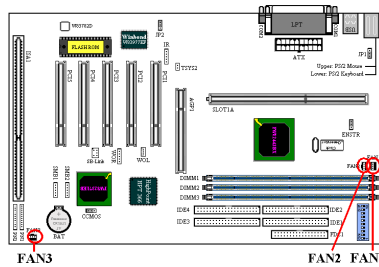
FAN1, FAN2 & FAN3: FAN header

Attach the connector from the individual CPU fan to the header named FAN1, and attach the connector from the chassis fan to FAN2 or & FAN3 header.

You must attach the CPU fan to the processor, or your processor will work abnormally or may be damaged by overheating. Also, if you want the computer case's internal temperature to be kept steady and not too high, you had better connect the chassis fan to reach this goal.

Note: Watch the pin position and the orientation

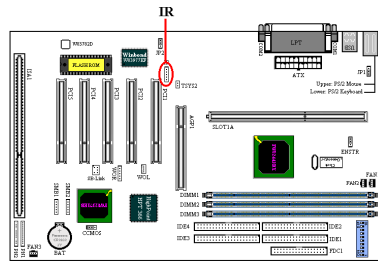
IR: IR Header (Infrared)

There is a specific orientation for pins 1 through 5, attach the connector from the IR KIT or IR device to the IR header. This motherboard supports standard IR transfer rates.

Note: Watch the pin position and the orientation

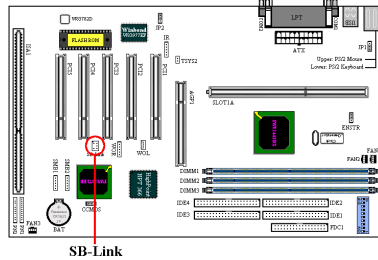
SB-Link: SB-Link™ Header

If your PCI audio adapter supports this feature, then you can connect the specific cable from the audio adapter to this header. SB-LINK™ combines Intel's PC-PCI and "Serialized IRQ" protocols. These technologies can be found in Intel's TX, LX, BX and newer core logic chipsets. This technology provides the DMA and IRQ signals present in ISA Bus today, but not available on the PCI Bus. The SB-LINK™ serves as a bridge between the motherboard and PCI sound card to deliver Sound card for real-mode DOS games. Check to see if your card supports this.

Note: Watch the pin position and the orientation

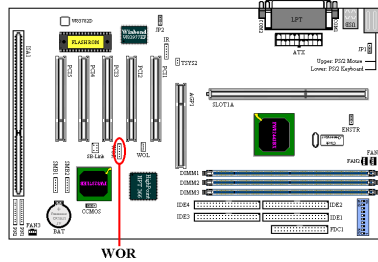
WOR: Wake On Ring Header

If you have an internal modem adapter that supports this feature, then you can connect the specific cable from the internal modem adapter to this header. This feature lets you wake up your computer via remote control through the modem.

Note: Watch the pin position and the orientation

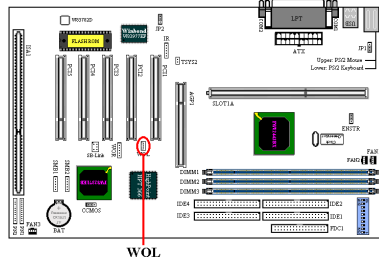
WOL: Wake on LAN Header

If you have a Network adapter that supports this feature, then you can connect the specific cable from the network adapter to this header. This feature lets you wake up your computer via remote control through a local area network. You may need a specific utility to control the wake up event, like using the Intel® LDCM® utility or other similar utilities.

Note: Watch the pin position and the orientation

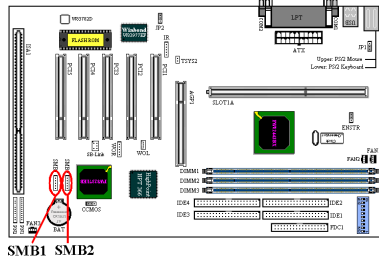
SMB1 & SMB2 header: System Management Bus Connector

This connector is reserved for system management bus (SMBus). The SMBus is a specific implementation of an I²C bus. I²C is a multi-master bus, which means that multiple chips can be connected to the same bus and each one can act as a master by initiating a data transfer. If more than one master simultaneously tries to control the bus, an arbitration procedure decides which

master gets priority.

Note: Watch the pin position and the orientation

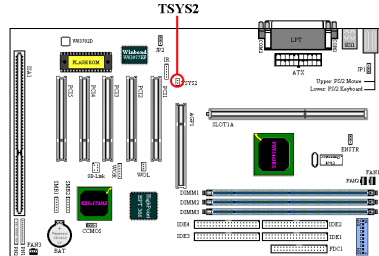
TSYS2 header:

The TSYS2 is for you to connect an additional thermistor to detect the temperature in the location of your choice. You can attach one end of the two-threaded thermal cable that comes with the motherboard to the TSYS2 header, then tape the other end of thermal cable on the device you want to detect its temperature.

JP1 Header: Disable or Enable Keyboard/Mouse Wake Up

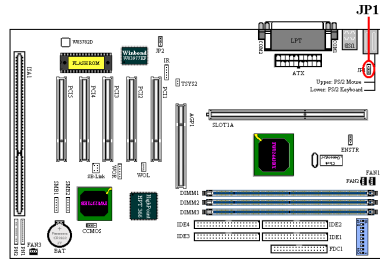

This header is used to Disable or Enable keyboard/mouse wake up function. This function has to cooperate with the BIOS setting (see section 3-5).

Short pin 1-2	Disable keyboard/mouse Wake Up
Short pin 2-3	Enable keyboard/mouse Wake Up (default)

JP2 Header: Disable or Enable Power Recovery

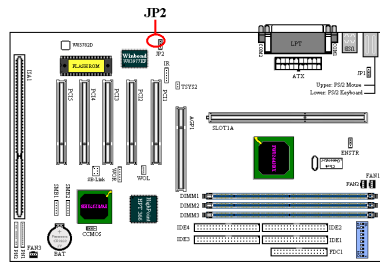

This header is used to Disable or Enable power recovery function. This function has to cooperate with the BIOS setting (see section 3-5).

Short pin 1-2	Disable power recovery
Short pin 2-3	Enable power recovery (default)

NOTE

If you enable the power recovery function and connect a ZIP device to the LPT port, you have to turn off the power of your ZIP device after you shutdown your computer. Otherwise, the onboard battery will run down.

CCMOS: CMOS Discharge Jumper

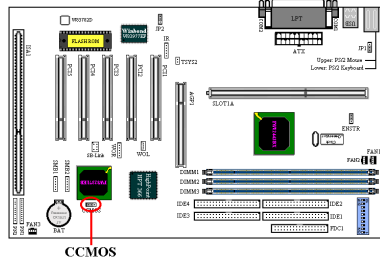

Jumper CCMOS discharge CMOS memory. When you install the motherboard, make sure this jumper is set for normal operation (pin 1 and 2 shorted). See figure 2-6.

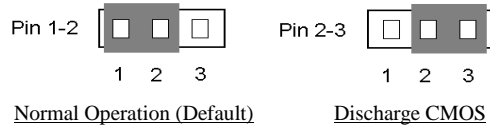
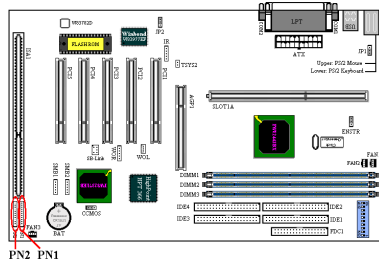

Figure 2-6. CCMOS jumper setting

Note

Before you clear the CMOS, you have to turn the power off first (including the +5V standby power). Otherwise, your system may work abnormally or malfunction.

PN1 and PN2 Headers



PN1 and PN2 are for switches and indicators for the chassis's front panel, there are several functions that come from these two headers. You have to watch the pin position and the orientation, or you may cause system malfunctions. Figure 2-7 shows you the PN1 and PN2 functions of the pins.

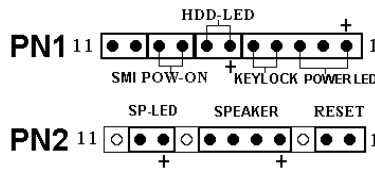
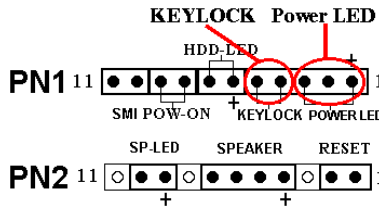

Figure 2-7. The definition of PN1 and PN2 pins

PN1 (Pin 1-2-3-4-5): Power LED and Keylock Switch Headers



There is a specific orientation for pins 1 through 3. Insert the three-threaded power LED cable to pins 1~3, and the two-threaded keylock cable into pin 4 and pin 5. Check to make sure the correct pins go to the correct connectors on the motherboard. If you install them with the wrong direction, the

power LED light will not illuminate correctly.

Note: Watch the power LED pin position and orientation.

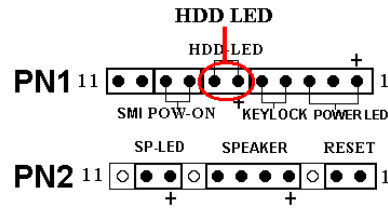
PN1 (Pin 6-7): HDD LED Header

Attach the cable from the case's front panel HDD LED to this header. If you install it in the wrong direction, the LED light will not illuminate correctly.

Note: Watch the HDD LED pin position and the orientation.

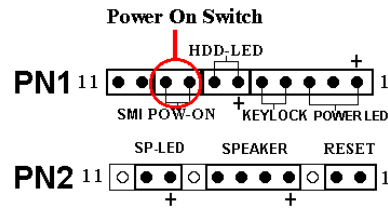
PN1 (Pin 8-9): Power on Switch Header

Attach the cable from the case's front panel power switch to this header.

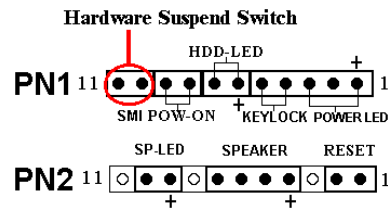
PN1 (Pin 10-11): Hardware Suspend Switch (SMI Switch) Header

Attach the cable from the case's front panel suspend switch (if there is one) to this header. Use this switch to enable/disable the power management function by hardware.

Note: If you enable the ACPI function in the BIOS setup, this function will not work.

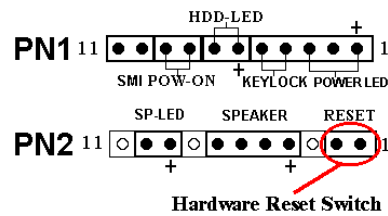
PN2 (Pin 1-2): Hardware Reset Switch Header

Attach the cable from the case's front panel Reset switch to this header. Press and hold the reset button for at least one second to reset the system.

PN2 (Pin 4-5-6-7): Speaker Header

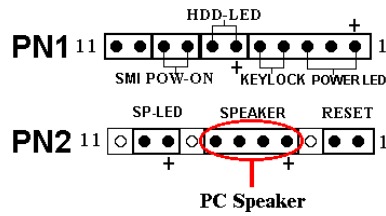

Attach the cable from the system speaker to this header.

PN2 (Pin 9-10): Suspend LED Header

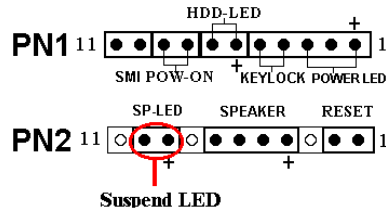

Insert the two-threaded suspend LED cable into pin 9 and pin 10. If you install it in the wrong direction, the LED light will not illuminate correctly.

Note: Watch the HDD LED pin position and the orientation.

For the PN1 and PN2 pin's count-name list, please refer to table 2-2.

Table 2-2. PN1 and PN2 pin count name list

PIN Name		Significance of signal	PIN Name		Significance of signal
PN1	PIN 1	+5VDC	PN2	PIN 1	Ground
	PIN 2	No connection		PIN 2	Reset input
	PIN 3	Ground		PIN 3	No connection
	PIN 4	Keyboard inhibit Signal		PIN 4	+5VDC
	PIN 5	Ground		PIN 5	Ground
	PIN 6	LED power		PIN 6	Ground
	PIN 7	HDD active		PIN 7	Speaker data
	PIN 8	Ground		PIN 8	No connection
	PIN 9	Power On/Off signal		PIN 9	+5VDC
	PIN 10	+3V Standby		PIN 10	Suspend LED active
	PIN 11	Suspend signal		PIN 11	No connection

Let's now see the I/O connectors that BE6-II uses, and what their functions are.

FDC1 Connector

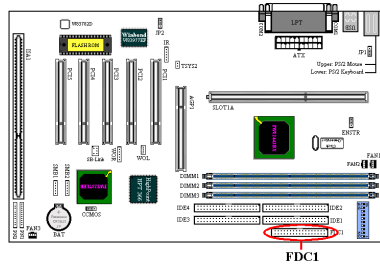

This 34-pin connector is called the “*floppy disk drive connector*”. You can connect a 360K, 5.25”, 1.2M, 5.25”, 720K, 3.5”, 1.44M, 3.5” or 2.88M, 3.5” floppy disk drive, you can even connect a 3 Mode floppy disk drive (it’s a 3 1/2” drive used in Japanese computer systems).

A floppy disk drive ribbon cable has 34 wires and two connectors to provide for the connection of two floppy disk drives. After connecting the single end to the FDC1, connect the two connectors on the other end to the floppy disk drives. In general, people only install one floppy disk drive on their computer system.

Note

A red mark on a wire typically designates the location of pin 1. You need to align the wire pin 1 to the FDC1 connector pin 1, then insert the wire connector into the FDC1 connector.

IDE1 and IDE2 Connectors

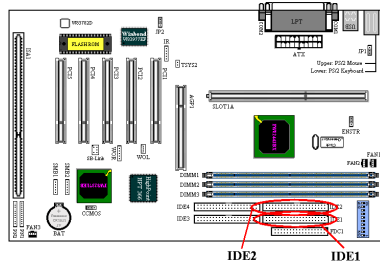

An IDE hard disk drive ribbon cable has 40 wires and two connectors to provide a connection for two IDE hard disk drives. After connecting the single end to the IDE1 (or IDE2), connect the two connectors on the other end to the IDE hard disk drives (or CD-ROM drive, LS-120, etc.).

Before you install a hard disk, there are some things you need to be aware of:

- ◆ “Primary” refers to the first connector on the motherboard, that is, the IDE1 connector on the motherboard.
- ◆ “Secondary” refers to the second connector on the motherboard, that is, the IDE2 connector on the motherboard.
- ◆ Two hard disks can be connected to each connector:
The first HDD is referred to as the “Master”,

The second HDD is referred to as the “Slave”.

- ◆ For performance issues, we strongly suggest you don’t install a CD-ROM drive on the same IDE channel as a hard disk. Otherwise, the system performance on this channel may drop. (how much depends on your CD-ROM drive performance)

Note

- The Master or Slave status of the hard disk drive is set on the hard disk itself. Please refer to the hard disk drive user’s manual.
- A red mark on a wire typically designates the location of pin 1. You need to align the wire pin 1 to the IDE1 (or IDE2) connector pin 1, then insert the wire connector into the IDE1 (or IDE 2) connector.

IDE3 and IDE4: ATA/66 Connectors

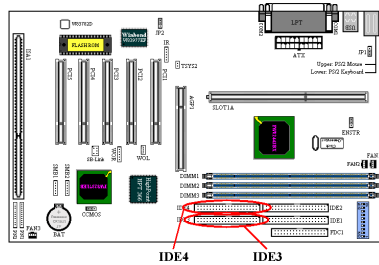

The BE6-II supports the Ultra ATA/66 (Also known as Ultra DMA/66) specification. It enhances existing Ultra ATA/33 technology by increasing both performance and data integrity. This new high-speed interface doubles the Ultra ATA/33 burst data transfer rate to 66.6 Mbytes/sec. The result is maximum disc performance using the current PCI local bus environment. Figure

2-8 shows you the different between the Ultra ATA/33 and Ultra ATA/66 Conductor Cable.

NOTE

HPT 366 IDE controller is designed to support high-speed mass storage. Thus we don’t suggest you connect non-disk devices that use ATA/ATAPI interfaces, such as CD-ROM to HPT 366 IDE connector (IDE3&IDE4).

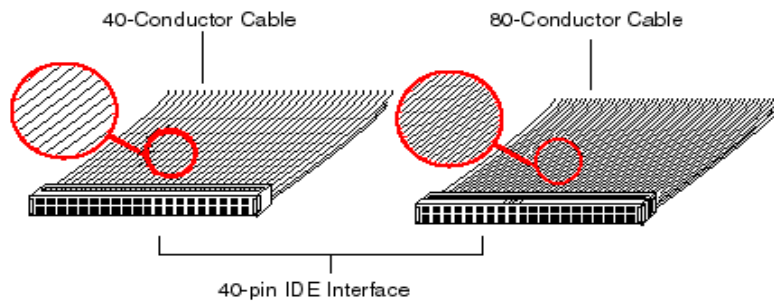
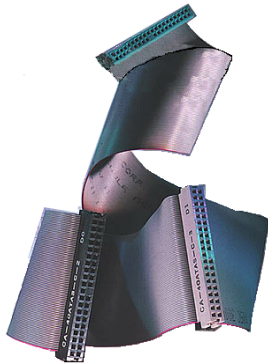

Figure 2-8. The difference between Ultra ATA/33 and Ultra ATA/66 Conductor Cables

Figure 2-9 shows you a photo of an Ultra ATA/66 Conductor Cable. An Ultra ATA/66-capable cable is a 40-pin, 80-conductor cable with a black connector on one end, a blue connector on the other end and a gray connector in the middle. In addition, line 34 on the cable should be notched or cut (this may be difficult to see).

Ultra ATA/66 is backwards compatible with all Ultra ATA/33 systems, but it will be limited in its transfer mode to the Ultra ATA/33 (Ultra DMA Mode 2 - 33 Mbytes/sec) or PIO Mode 4 (16.6 Mbytes/sec). Ultra ATA/66 hard drives are 100 percent backward compatible with both Ultra ATA/33 and DMA and with existing ATA (IDE) hard drives, CD-ROM drives, and host systems. The Ultra ATA/66 protocol and commands are designed to be compatible with existing ATA (IDE) devices and systems. Although a new 40-pin, 80-conductor cable is required for Ultra ATA/66, the chip set pin connector remains the same at 40. Hard drives that support Ultra ATA/66 also support Ultra ATA/33 and legacy ATA (IDE) specifications.



There are four requirements for attaining Ultra ATA/66:

- *The drive must support Ultra ATA/66.
- *The motherboard and system BIOS (or an add-in controller) must support Ultra ATA/66.
- *The operating system must support Direct Memory Access (DMA); Microsoft Windows 98 and Windows 95B (OSR2) support DMA.
- *The cable must be 80-conductor; the length should not exceed 18 inches. If all the above requirements are met, you can enjoy the Ultra ATA/66 features of your computer system.

Figure 2-9. Photo of an Ultra ATA/66 Conductor Cable

How to install the Ultra ATA/66 Cable Assembly:

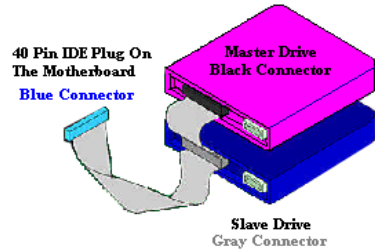

Figure 2-10. How to connect an ATA/66 Cable to the Motherboard

- The **BLUE** connector **MUST** be plugged into the motherboard or your system will not work.
- Each connector on the Ultra ATA/66 cable assembly has a small polarization tab centrally located on the body of the plastic. This fits into the matching slot on the mating plugs on the motherboard and the drives, thus assuring positive mating (pin #1 to pin #1)

- The red line on the cable should be aligned with pin #1. On the drives this will result in the red line facing the power connector. Attach the **BLUE** connector to the appropriate 40 pin IDE plug on the motherboard.
- Attach the **BLACK** connector to the mating plug on the master hard drive. Attach the **GREY** connector to the mating plug on the slave drive (secondary hard drive, CD ROM, or tape drive). Please refer figure 2-10.

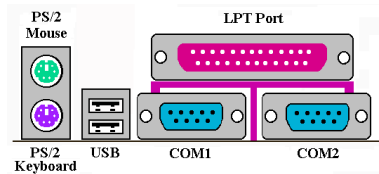
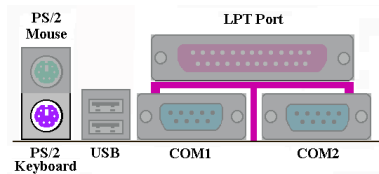

Figure 2-11. BE6-II back panel connectors

Figure 2-11 shows the BE6-II back panel connectors, these connectors are for connection to outside devices to the motherboard. We will describe which devices will attach to these connectors below.

KBM Lower: PS/2 Keyboard Connector

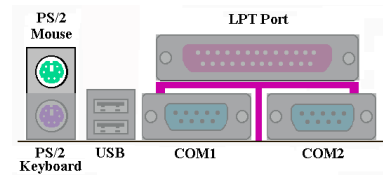

Attach a PS/2 keyboard connector to this 6-pin Din-connector. If you use an AT keyboard, you can go to a computer store to purchase an AT to ATX converter adapter, then you can connect your AT keyboard to this connector. We suggest you use a PS/2 keyboard for best compatibility.

KBM Upper: PS/2 Mouse Connector

Attach a PS/2 mouse to this 6-pin Din-connector.

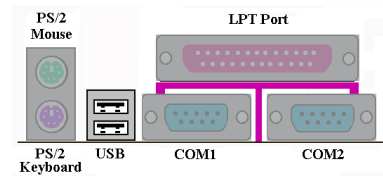
USB Port Connectors

This motherboard provides two USB ports. Attach the USB connector from the individual device to these connectors. You can attach USB devices such as a scanner, monitor, mouse, keyboard, hub, CD-ROM, joystick etc. to one of each USB connector.

You must make sure your operating system supports this feature and you may need to install an additional driver for individual devices. Please refer to your device user's manual for detailed information.

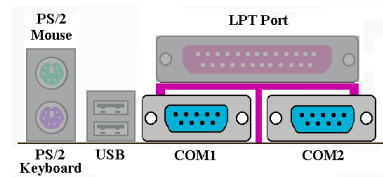
Serial Port COM1 and COM2 Connector

This motherboard provides two COM ports, you can connect an external modem, mouse or other devices that support this communication protocol.

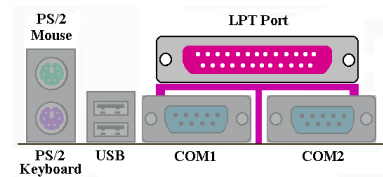
Parallel Port Connector

This parallel port is also called an "LPT" port, because it usually connects to the printer. You can connect other devices that support this communication protocol, like a scanner, M.O. drive, etc.

2-5. CPU Frequency Settings

The BE6-II provides two ways to configure CPU settings. One uses the ABIT CPU Soft Menu III technology, the other uses DIP Switches. You can use the DS10 to enable or disable Soft Menu III.

NOTE

When you enable Soft Menu III, all DIP switches must be set to OFF.

DIP SW (DS1-DS8): DIP Switch for Setting CPU Frequency

The following tables will present the adjustment for the CPU frequency and multiplier factor. (The default settings are all "OFF.")

Multiplier Factor	DS1	DS2	DS3	DS4	External Clock Frequency	DS5	DS6	DS7	DS8
1.5	ON	OFF	ON	ON	66	OFF	OFF	OFF	OFF
2.0	OFF	ON	ON	OFF	75	OFF	ON	OFF	OFF
2.0	ON	OFF	OFF	ON	83	ON	OFF	OFF	OFF
2.5	OFF	OFF	ON	OFF	100	OFF	OFF	ON	OFF
3.0	OFF	ON	OFF	OFF	103	ON	ON	ON	OFF
3.5	OFF	OFF	OFF	OFF	112	OFF	ON	ON	OFF
4.0	OFF	ON	ON	ON	124	ON	ON	OFF	OFF
4.5	OFF	OFF	ON	ON	133	ON	OFF	ON	OFF
5.0	OFF	ON	OFF	ON					
5.5	OFF	OFF	OFF	ON					
6.0	ON	ON	ON	OFF					
6.5	ON	OFF	ON	OFF					
7.0	ON	ON	OFF	OFF					
7.5	ON	OFF	OFF	OFF					
8.0	ON	ON	ON	ON					

AGP Frequency

The DS9 lets you set the frequency ratio between AGP clock and the Front Side Bus (CPU Bus). Generally, if you set the CPU FSB clock to 66MHz, you ought to set this switch to "OFF (1/1)". If you set the CPU FSB clock to 100Mhz or higher, you ought to set this switch to "ON (2/3)"

DS9	
ON	AGP Clock / Front Side Bus = 2/3
OFF	AGP Clock / Front Side Bus = 1/1

Soft Menu III

The DS10 lets you enable or disable Soft Menu III. The Soft Menu III allows you to configure the CPU settings easily through BIOS setup (refer to section 3-1). When you enable Soft Menu III, all DIP switches must be set to OFF.

DS10	
ON	Disable Soft Menu III
OFF	Enable Soft Menu III

Chapter 3. Introduction of the BIOS

The BIOS is a program located on a Flash Memory chip on the motherboard. This program will not be lost when you turn the computer off. This program is also referred to as the “boot” program. It is the only channel for the hardware circuit to communicate with the operating system. Its main function is to manage the setup of the motherboard and interface cards parameters, including simple parameters such as time, date, hard disk drive, as well as more complex parameters such as hardware synchronization, device operating mode, **CPU SOFT MENU™ III** features and setup of CPU speed. The computer will operate normally, or will operate at its best, only if all these parameters are correctly and optimally configured through the BIOS.



Do not change the parameters inside the BIOS unless you fully understand their meanings and consequences.

The parameters inside the BIOS are used to setup the hardware synchronization or a device's operating mode. If the parameters are not correct, they will produce errors, the computer will crash, and sometimes you will even not be able to boot the computer after it has crashed. We recommend that you do not change the parameters inside the BIOS unless you are very familiar with them. If you are not able to boot your computer anymore, please refer to the “CMOS Discharge Jumper” in Section 2-4, Chapter 2.

When you start the computer, it is controlled by the BIOS program. The BIOS first operates an auto-diagnostic test called POST (Power On Self Test) for all the necessary hardware, it then configures the parameters of the hardware synchronization, and detects all the hardware. Only when these tasks are completed does it give up control of the computer to the program of the next level, which is the operating system (OS). Since the BIOS is the only channel for hardware and software to communicate, it is the key factor for system stability, and in insuring that your system performs at its best. After the BIOS has achieved the auto-diagnostic and auto-detection operations, it will display the following message:

PRESS DEL TO ENTER SETUP

The message will be displayed for three to five seconds, if you press the **Del** key, you will access the BIOS Setup menu. At that moment, the BIOS will display the following screen:

Note

- ❶ To improve stability and functions, BIOSes are constantly improving, therefore; the BIOS screens in this chapter may not fully match your current BIOS screen.
- ❷ All default setting is use the *Load Optimized Defaults* settings. If you use the *Load Fail-Safe Defaults*, some items default values will be changed.



Figure 3-1. CMOS Setup Utility Main Screen Shot

This motherboard uses a totally different operating interface so the Award BIOS screens are different than in other versions. It provides more functions with increased user friendliness. In the BIOS Setup main menu in Figure 3-1, you can see several options. We will explain these options step by step in the following pages of this chapter, but let us first see a short description of the function keys you may use here:

- Press **↑↓→←** (up, down, and right) to choose the option you want to confirm or to modify in the main menu.
- Press the **Enter** key to select the item you want. Simply move the highlight to the field you want to select, and press Enter.
- Press **F10** when you have completed setting up the BIOS parameters to save them and exit the BIOS Setup menu.
- Press **Esc** to *Exit* the BIOS Setup.
- Press **F1** to display the General Help screen.

In addition to the **Item Help** window, more information can be provided for the alternate

function by pressing the F1 key in any menu in the BIOS.

- Press **F5** to reset current screen settings to their Setup Default values.
- Press **F6** to return to the *Fail-Safe Default* setting i.e. if you use the wrong settings causing a system boot failure, use this function key to quickly return to the system default settings.
- Press **F7** to quickly set the system to the *Optimized Defaults* setting.

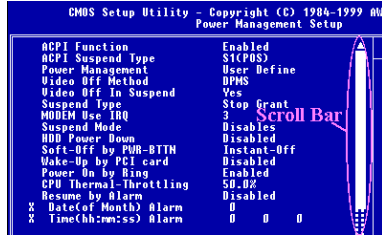

In some setup menu screens, you can see the scroll bar on the right side of the window. You can use the **↑** and **↓** keys or the up and down arrow keys to scroll the screen to view more help information or functions to select.

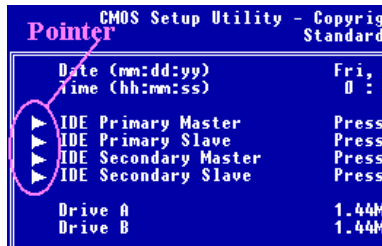

You may see the right cursor symbol appear on the left side of some items, indicating that additional information or options can be select in a Sub-Menu for this item.

Note

The item heading in the square outlet represents the default setting for that field

Computer Knowledge: CMOS Data

Maybe you have heard of someone losing CMOS DATA. What is the CMOS? Is it important? CMOS is the memory in which the BIOS parameters that you have configured are stored. This memory is passive, you can both read its data, and store data in it. But this memory has to be powered by a battery in order to avoid data loss when the computer is turned off. If the CMOS battery dies, you will loose all CMOS data. We therefore recommend that you write down all the parameters of your hardware, or you put a label with these parameters on your hard disk.

3-1. ABIT SoftMenu III

The CPU can be setup through a programmable switch (**CPU SOFT MENU™ III**), that replaces the traditional manual hardware configuration. This feature allows the user to more easily complete the installation procedures. You can install the CPU without configuring any jumpers or switches. The CPU must be setup according its specifications.

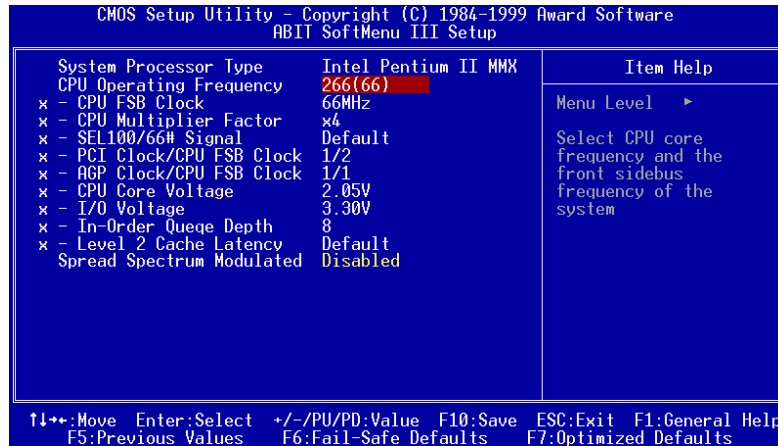

Figure 3-2. CPU Soft Menu™ III Screen Shot

System Processor Type:

- ▶ Intel Pentium III MMX
- ▶ Intel Pentium II MMX
- ▶ Intel Celeron MMX

CPU Operating Frequency:

This option sets the CPU speed.

In this field, the CPU speed is indicated like this: CPU speed = External clock * Multiplier factor, select the CPU speed according the type and the speed of your CPU.

For Intel Pentium II and Celeron™ PPGA MMX processors, you can choose the following settings:

- 233 (66) ➤266 (66) ➤300 (66) ➤300 (100) ➤333 (66)
- 350 (100) ➤366 (66) ➤400 (66) ➤400(100) ➤433 (66)
- 450 (100) ➤466 (66) ➤500 (66) ➤500 (100) ➤550 (100)
- 600(100) ➤650 (100) ➤700 (100) ➤User Define

Note

CPU bus speed above 66MHz/100MHz supported but not guaranteed due to the PCI and chipset specs.

User defined external clock and multiplier factor:

➤ **User Defined:**

When you choose the *User Define*, you will be able to set the following five items.



Warning



The wrong settings of the multiplier and external clock in certain circumstances may cause CPU damage. Setting the working frequency higher than the PCI chipset or processor specs, may cause abnormal memory module functioning, system hangs, hard disk drive data lose, abnormal functioning of the VGA card, or abnormal functioning with other add-on cards. Using non-specification settings for your CPU is not the intention of this explanation. These should be used for engineering testing, not for normal applications.

If you use non-specification settings for normal operation, your system may not be stable, and may effect system reliability. Also, we do not guarantee the stability and compatibility for settings that are not within specification, and any damage of any elements on the motherboard or peripherals, is not our responsibility.

— **CPU FSB Clock:**

- 66MHz (1/2) ➤75MHz (1/2) * ➤83MHz (1/2)*
- 84Mhz ~ 200MHz

Note

CPU bus speed above 66MHz/100MHz supported but not guaranteed due to the PCI and chipset specs.

— **Multiplier Factor:**

You can choose the following multiplier factors:

▶ x 2 ▶ x 2.5 ▶ x 3 ▶ x 3.5 ▶ x 4 ▶ x 4.5 ▶ x 5 ▶ x 5.5 ▶ x 6
 ▶ x 6.5 ▶ x 7 ▶ x 7.5 ▶ x 8

— **SEL100/66# Signal**

Two options are available: Default and Low. The default setting is “Default”.

— **PCI Clock/CPU FSB Clock**

Three options are available: 1/2, 1/3 and 1/4. This item lets you set the PCI clock. It correlates with the CPU FSB clock you set. For example, if you set the CPU FSB clock to 100MHz and choose 1/3 here, the PCI clock will be 33.3 MHz.

— **AGP Clock/CPU FSB Clock**

Two options are available: 1/1 and 2/3. This item lets you set the AGP clock. It correlates with the CPU FSB clock you set. The default setting is “1/1”. In this case, the AGP clock will equal to the CPU FSB clock. If you choose “2/3”, the AGP clock will be the CPU FSB clock divided by 3 and times 2. Generally, if you set the CPU FSB clock to 66MHz, you ought to select “1/1”. If you set the CPU FSB clock to 100Mhz or higher, you ought to select “2/3”.

— **CPU Core Voltage**

This item lets you select the CPU core voltage manually. You can change values in the “**CPU Core Voltage**” option lists by using the arrow up and down keys.

!!! Warning !!!

You must check the CPU document to make sure your CPU core voltage before you want to adjust this item. Incorrect CPU core voltage settings in certain circumstances may cause CPU damage.

— **I/O Voltage**

This item lets you select the voltage supplied to the DRAM, chipset and AGP. You can change values in the “**I/O Voltage**” option lists by using the arrow up and down keys.

!!! Warning !!!

Using a higher voltage may result in the shortening of your computer components' life. We strongly suggest you leave this item on default setting.

— **In-Order Queue Depth**

Two options are available: 1 and 8. This item lets you set cache buffer for CPU data processing. If you are not well acquainted with this item setting, please leave it on

the default setting (8).

— **Level 2 Cache Latency:**

Sixteen settings are available, Default, and 1 to 15. This item can let you adjust the processor L2 cache speed, the larger the value, the faster the L2 cache will run. You have to be aware that if you set the L2 cache speed too fast, it will cause the L2 cache to fail. If the L2 cache fails it will cease to run until you reset the value, but the processor and L1 cache will still function, just not as well. To make sure your L2 cache functions properly please choose an appropriate setting. The default setting is *Default*.

Normally, we do not recommend that you use the “User Define” option to setup CPU speed and multiplier factors. This option is for setup of future CPUs whose specifications are still unknown. The specifications of all present CPUs are included in the default settings. Unless you are very familiar with all CPU parameters, it is very easy to make mistakes when you define the external clock and the multiplier factor by yourself.

Solution in case of booting problem due to invalid clock setup:

Normally, if the CPU clock setup is wrong, you will not be able to boot. In this case, turn the system off then on again. The CPU will automatically use its standard parameters to boot. You can then enter the BIOS Setup again and set up the CPU clock. If you can't enter the BIOS setup, you must try turning the system on a few times (3~4 times) or press “INSERT” key when turning on and the system will automatically use its standard parameters to boot. You can then enter BIOS SETUP again and set up the new parameters.

When you change your CPU:

This motherboard has been designed in such a way that you can turn the system on after having inserted a CPU in the socket without having to configure any jumpers or DIP switches. But if you change your CPU, normally you just have to turn off the power supply, change the CPU and then, set up the CPU parameters through **SOFT MENU™ III**. However, if the new CPU is slower than the old one (and is same brand and type), we offer you two methods to successfully complete the CPU change operation.

Method 1: Setup up the CPU for the lowest speed for its brand. Turn the power supply off and change the CPU. Then turn the system on again, and set up the CPU parameters through **SOFT MENU™ III**.

Method 2: Since you have to open the computer case when you change the CPU, it could be a good idea to use the CCMOS jumper to erase the parameters of the original CPU and to enter BIOS Setup to set up CPU parameters again.

Attention

After setting up the parameters and leaving the BIOS SETUP, and having verified that the system can be booted, do not press the Reset button or turn off the power supply. Otherwise the BIOS will not read correctly, the parameters will fail and you must enter **SOFT MENU™ III** again to set up the parameters all over again.

Spread Spectrum Modulated

For EMC (**E**lectro-**M**agnetic **C**ompatibility Test) testing you maybe need to adjust this item for optimal results, we do not recommend you change the default, except for special reasons.

3-2. Standard CMOS Features Setup Menu

This contains the basic configuration parameters of the BIOS. These parameters include date, hour, VGA card, FDD and HDD settings.

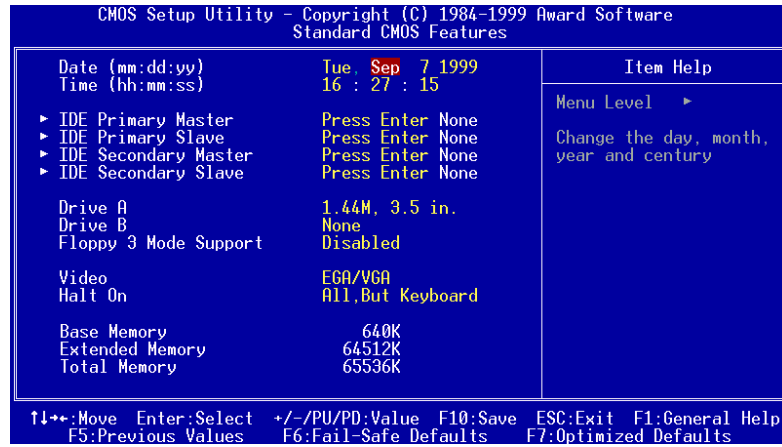

Figure 3-3. Standard CMOS Setup Screen Shot

Date (mm:dd:yy):

You can set the date in this item: month (mm), date (dd) and year (yy).

Time (hh:mm:ss):

You can set the time in this item: hour (hh), minute (mm) and second (ss).

IDE Primary Master / Slave and IDE Secondary Master / Slave:

These items have a sub-menu to let you choose further options. You can refer to the follow figure to check what options are available.

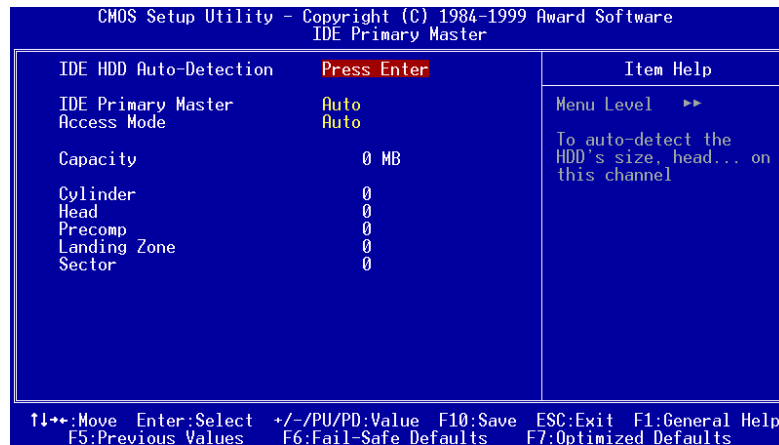

Figure 3-4. IDE Primary Master Setup Screen Shot

☞ IDE HDD Auto-Detection:

Press the *Enter* key for the BIOS to auto detect all detailed parameters of the hard disk drivers (HDD). If auto detection is successful, the correct values will be shown in the remaining items of this menu.

Note

- ❶ A new IDE HDD must be first formatted, otherwise it can not read/write. The basic step in using a HDD is to make a **HDD low-level format**, then run FDISK, and then FORMAT the drive. Most current HDDs have already been subjected to low-level format at the factory, so you can probably skip this operation. Remember though, the primary IDE HDD must have its partition set to active within the FDISK procedure.
- ❷ If you are using an old HDD that is already formatted, auto detection can not detect the correct parameters. You may need to do a low-level format or set the parameters manually, and then check if the HDD is working.

☞ IDE Primary Master:

Three settings are available: *Auto*, *Manual* and *None*. If you choose *Auto*, the BIOS will automatically check what kind hard disk you are using. If you want to set the HDD parameters yourself, make sure you fully understand the meaning of the parameters, and be sure to refer to the manual provided by the HDD manufacture to get the settings right.

☞ Access Mode:

Since old operating systems were only able to support HDDs with capacities no bigger than 528MB, any hard disk with more than 528MB was unusable. AWARD BIOS features a

solution to this problem: you can, according to your operating system, choose four operating modes: NORMAL → LBA → LARGE → Auto.

The HDD auto detection option in the sub-menu will automatically detect the parameters of your hard disk and the mode supported.

➤ **Auto:**

Just let the BIOS detect your HDD access mode and make the decisions.

➤ **Normal mode:**

Standard normal mode supports hard disks of up to 528MB or less. This mode directly uses positions indicated by Cylinders (CYLS), Heads, and Sectors to access data.

➤ **LBA (Logical Block Addressing) mode:**

The earlier LBA mode can support HDD capacities of up to 8.4GB, and this mode uses a different method to calculate the position of disk data to be accessed. It translates Cylinders (CYLS), Heads and Sectors into a logical address where data is located. The Cylinders, Heads, and Sectors displayed in this menu do not reflect the actual structure of the hard disk, they are just reference values used to calculate actual positions. Currently, all high capacity hard disks support this mode, that's why we recommend you use this mode. Currently, the BIOS can support the INT 13h extension function, enabling the LBA mode to support hard disk drive capacities exceeding 8.4GB.

➤ **Large Mode:**

When the number of cylinders (CYLS) of the hard disk exceeds 1024 and DOS is not able to support it, or if your operating system does not support LBA mode, you should select this mode.

📁 **Capacity:**

This item auto displays your HDD size. Note that this size is usually slightly greater than the size given by a disk checking program of a formatted disk.

Note

All the items below are available when you set the item *Primary IDE Master* to *Manual*.

📁 **Cylinder:**

When disks are placed directly above one another along the shaft, the circular vertical "slice" consisting of all the tracks located in a particular position is called a cylinder. You can set the number of cylinders for a HDD. The minimum number you can enter is 0, the maximum number you can enter is 65536.

📁 **Head:**

This is the tiny electromagnetic coil and metal pole used to create and read back the magnetic patterns on the disk (also called the read/write head). You can configure the

number of read/write heads. The minimum number you can enter is 0, the maximum number you can enter is 255.

 **Precomp:**

The minimum number you can enter is 0, the maximum number you can enter is 65536.

Warning

Setting a value of 65536 means no hard disk exists.

 **Landing Zone:**

This is a non-data area on the disk's inner cylinder where the heads can rest when the power is turned off. The minimum number you can enter is 0, the maximum number you can enter is 65536.

 **Sector:**

The minimum segment of track length that can be assigned to stored data. Sectors usually are grouped into blocks or logical blocks that function as the smallest units of data permit. You can configure this item to sectors per track. The minimum number you can enter is 0, the maximum number you can enter is 255.

Driver A & Driver B:

If you have installed the floppy disk drive here, then you can select the type of floppy drive it can support. Six options are available: None → 360K, 5.25 in. → 1.2M, 5.25in. → 720K, 3.5 in. → 1.44M, 3.5 in. → 2.88M, 3.5 in.

Floppy 3 Mode Support:

Four options are available: Disabled → Driver A → Driver B → Both. The default setting is *Disabled*. 3 Mode floppy disk drives (FDD) are 3 1/2" drives used in Japanese computer systems. If you need to access data stored in this kind of floppy, you must select this mode, and of course you must have a 3 Mode floppy drive.

Video:

You can select the VGA modes for your video adapter, four options are available: EGA/VGA → CGA 40 → CGA 80 → MONO. The default setting is EGA/VGA.

Halt On:

You can select which type of error will cause the system to halt. Five options are available:
All Errors → No Errors → All, But Keyboard → All, But Diskette → All, But Disk/Key.

You can see your system memory list in the lower right box, it shows the *Base Memory*, *Extended Memory* and *total Memory size* configurations in your system. It is detected by the system during boot-up procedure.

3-3. Advanced BIOS Features Setup Menu

In each item, you can press <Enter> at any time to display all the options for this item.

Attention

Advanced BIOS Features Setup Menu has already been set for maximum operation. If you do not really understand each of the options in this menu, we recommend you use the default values.

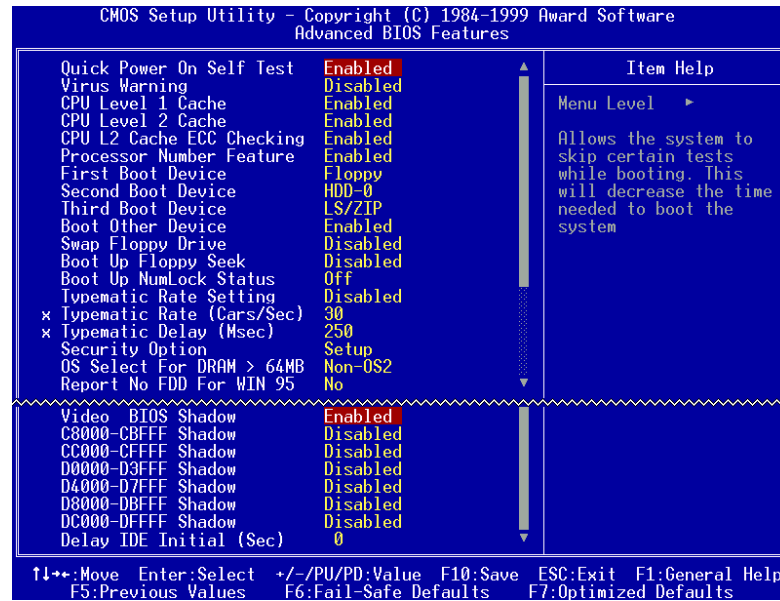

Figure 3-5. Advanced BIOS Features Setup Screen Shot

Quick Power On Self Test:

After the computer has been powered on, the BIOS of the motherboard will run a series of tests in order to check the system and its peripherals. If the Quick Power on Self-Test feature is enable, the BIOS will simplify the test procedures in order to speed up the boot process. The default setting is *Enabled*.

Virus Warning:

This item can be set to Enabled or Disabled, the default setting being *Disabled*. When this feature is enabled, if there is any attempt from a software or an application to access the boot sector or the partition table, the BIOS will warn you that a boot virus is attempting to access the hard disk.

CPU Level 1 Cache:

This item is used to enable or to disable the CPU level 1 cache. When the cache is set to *Disabled* it is much slower, so the default setting for this item is *Enabled* since it will speed up memory access. Some old and very poorly written programs will make the computer malfunction or crash if the system speed is too high. In this case, you should disable this feature. The default setting is *Enabled*.

CPU Level 2 Cache:

This item is used to enable or to disable the CPU level 2 cache. When the external cache is *enable*, it will speed up memory access, and the system works faster. The default setting is *Enabled*.

CPU L2 Cache ECC Checking:

This item is used to enable or to disable the CPU level 2 cache ECC (Error Correction Code) checking function. The default setting is *Enabled*.

Processor Number Feature:

This feature can let the program read the data inside your processor. This feature only works with Intel® Pentium® III processors. When you install a Pentium® III processor into your motherboard, and when your system boots-up then this item will show up in BIOS.

Two items will be available: Enabled and Disabled. When you choose Enabled, the specific program can read your processor's serial number. When you choose Disabled it will not allow the program to read your processor's serial number. The default setting is Disabled.

First Boot Device:

When the computer boots up, the BIOS attempts to load the operating system from the devices in the sequence selected in these items: floppy disk drive A, LS/ZIP devices, hard

drive C, SCSI hard disk drive or CD-ROM. There are ten options for the boot sequence that you can choose (The default setting is *Floppy*):

Floppy → LS/ZIP → HDD-0 → SCSI → CDROM → HDD-1 → HDD-2 → HDD-3 → LAN → UDMA66.

Second Boot Device:

Description is the same as the *First Boot Device*, the default setting is *HDD-0*.

Third Boot Device:

Description is same as the *First Boot Device*, the default setting is *LS/ZIP*

Boot Other Device:

Two options are available: Enabled or Disabled. The default setting is *Enabled*. This setting allows the BIOS to try three kinds of boot devices that set from the above three items.

Swap Floppy Drive:

This item can be set as Enabled or Disabled. The default setting is *Disabled*. When this feature is enabled, you don't need to open the computer case to swap the position of floppy disk drive connectors. Drive A can be set as drive B and drive B can be set as drive A.

Boot Up Floppy Seek:

When the computer boots up, the BIOS detects if the system has a FDD or not. When this item is enable, if the BIOS detects no floppy drive, it will display a floppy disk drive error message. If this item is disabled, the BIOS will skip this test. The default setting is *Disabled*.

Boot Up NumLock Status:

- ▶ On: At boot up, the Numeric Keypad is in numeric mode. (Default Settings)
 - ▶ Off: At boot up, the Numeric Keypad is in cursor control mode.
-

Typematic Rate Setting:

This item allows you to adjust the keystroke repeat rate. When set to *Enabled*, you can set the two keyboard typematic controls that follow (*Typematic Rate* and *Typematic Rate*

Delay). If this item is set to *Disabled*, the BIOS will use the default setting. The default setting is *Enabled*.

Typematic Rate (Chars/Sec):

When you press a key continuously, the keyboard will repeat the keystroke according to the rate you have set (Unit: characters/second) . Eight options are available: 6 → 8 → 10 → 12 → 15 → 20 → 24 → 30 → Back to 6. The default setting is 30.

Typematic Delay (Msec):

When you press a key continuously, if you exceed the delay you have set here, the keyboard will automatically repeat the keystroke according to a certain rate (Unit: milliseconds). Four options are available: 250 → 500 → 750 → 1000 → Back to 250. The default setting is 250.

Security Option:

This option can be set to System or Setup. The default setting is *Setup*. After you have created a password through PASSWORD SETTING, this option will deny access to your system (System) or modification of computer setup (BIOS Setup) by unauthorized users.

►**SYSTEM:** When you choose System, a password is required each time the computer boots up. If the correct password is not given, the system will not start.

►**SETUP:** When you choose Setup, a password is required only when accessing the BIOS Setup.

If you have not set a password in the PASSWORD SETTING option, this option is not available.

To disable security, select *Set Supervisor Password* at main menu and then you will be asked to enter password. Do not type anything and just press the *Enter* key and it will disable security. Once security is disabled, the system will boot and you can enter the *BIOS setup menu* freely

Notice

Don't forget your password. If you forget the password, you will have to open the computer case and clear all information in the CMOS before you can start up the system. But by doing this, you will have to reset all previously set options.

OS Select For DRAM > 64MB:

When the system memory is bigger than 64MB, the communication method between the BIOS and the operating system will differ from one operating system to another. If you use OS/2, select *OS2*; if you are using another operating system, select *Non-OS2*. The default setting is *Non-OS2*.

Report No FDD For WIN 95:

When using Windows® 95 without a floppy drive, please set this item to *Yes*. Otherwise, set it to *No*. The default setting is *No*.

Video BIOS Shadow:

This option is used to define whether the BIOS on the video card uses the shadow feature or not. You should set this option to *Enabled*, otherwise the display performance of the system will greatly decrease.

Shadowing address ranges:

This option allows you to decide if the ROM BIOS area of an interface card at a specific address uses the shadow feature or not. If you have no interface card using this memory block, don't enable this option.

You have six address ranges you can select:

C8000-CBFFF Shadow, CC000-CFFFF Shadow, D0000-D3FFF Shadow, D4000-D7FFF Shadow, D8000-DBFFF Shadow, DC000-DFFFF Shadow.

Computer Knowledge: SHADOW

What is the SHADOW? The BIOS of standard video or interface cards is stored in ROM, and it is often very slow. With the Shadow feature, the CPU reads the BIOS on the VGA card and copies it into RAM. When the CPU runs this BIOS, the operation is speeded up.

Delay IDE Initial (sec):

This item is used to support some old models or special types of hard disks or CD-ROMs. They may need a longer amount of time to initialize and prepare for activation. Since the

BE6-II

BIOS may not detect those kinds of devices during system booting. You can adjust the value to fit such devices. Larger values will give more delay time to the device. The minimum number you can enter is 0, the maximum number you can enter is 15. The default setting is 0.

3-4. Advanced Chipset Features Setup Menu

The Advanced Chipset Features Setup Menu is used to modify the contents of the buffers in the chipset on the motherboard. Since the parameters of the buffers are closely related to hardware, if the setup is not correct or is false, the motherboard will become unstable or you will not be able to boot up. If you don't know the hardware very well, use default values (i.e. use the *Load Optimized Defaults* option). The only time you might consider making any changes is if you discover that data is being lost while using your system.

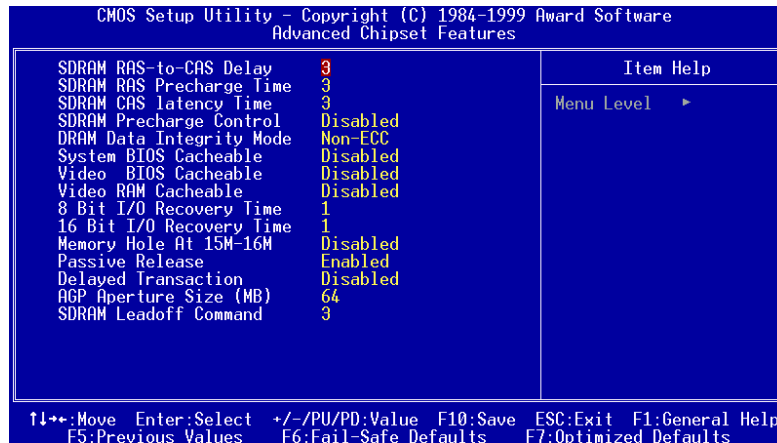

Figure 3-6. Advanced Chipset Features Setup Screen Shot

You can use the arrow keys to move between the items. Use **↑**, **↓** and **Enter** key to change the values. When you have finished setting up the chipset, press **Esc** to go back to the main menu.

The first chipset settings deal with CPU access to DRAM. The default timings have been carefully chosen and should only be altered if data is being lost. Such a scenario might well occur if your system has mixed speed DRAM chips installed so that greater delays may be required to preserve the integrity of the data held in the slower memory chips.

SDRAM RAS-to-CAS Delay

Two options are available: 2 and 3. The default setting is 3. This item lets you insert a timing delay between the CAS and RAS strobe signals, used when DRAM is written to, read from, or refreshed. *Fast* gives faster performance; and *Slow* gives more stable performance. This item applies only when synchronous DRAM is installed in the system.

SDRAM RAS Precharge Time:

Two options are available: 2 and 3. The precharge time is the number of cycles it takes for the RAS to accumulate its charge before DRAM refreshes. If insufficient time is allowed, refresh maybe incomplete and the DRAM may fail to retain data. This field applies only if synchronous DRAM is installed in the system.

SDRAM CAS Latency Time:

Two options are available: 2 and 3. The default setting is 3. You can select SDRAM CAS (Column Address Strobe) latency time according your SDRAM specification.

SDRAM Precharge Control:

This option determines the action taken when a page missing occurs (SDRAM only). When select Disabled, means SDRAM issue precharge on all command, and gives more stable performance.

DRAM Data Integrity Mode:

Two options are available: Non-ECC or ECC. This option is used to configure the type of DRAM in your system. ECC is Error Checking and Correction, when your memory is ECC memory, choose the ECC option.

System BIOS Cacheable:

You can select Enabled or Disabled. The default setting is *Enabled*. When you select *Enabled* allows caching of the system BIOS ROM at F0000h-FFFFFh, resulting in better system performance. However, if any program writes to this memory area, a system error may result.

Video BIOS Cacheable:

You can select Enabled or Disabled. The default setting is *Enabled*. When you select *Enabled* allows caching of the video BIOS, resulting in better system performance. However, if any program writes to this memory area, a system error may result.

Video RAM Cacheable:

You can select Enable or Disable. When you select Enabled, you get faster video RAM executing speed via the L2 cache. You must check your VGA adapter manual to find out if any compatibility problems will occur.

8 Bit I/O Recovery Time:

Nine options are available: NA → 8 → 1 → 2 → 3 → 4 → 5 → 6 → 7 → Back to NA. This option specifies the length of a delay inserted between consecutive 8 bit I/O operations. For an earlier 8 bit Add-on card, sometimes you need to adjust its recovery time to make it work normally.

16 Bit I/O Recovery Time:

Five options are available: NA → 4 → 1 → 2 → 3 → Back to NA. This option specifies the length of a delay inserted between consecutive 16 bit I/O operations. For an earlier 16 bit Add-on card, sometimes you need to adjust its recovery time to make it work normally.

Memory Hole At 15M-16M:

Two options are available: Enabled and Disabled. The default setting is *Disabled*. This option is used to reserve the memory block 15M-16M for ISA adapter ROM. Some special peripherals need to use a memory block located between 15M and 16M, and this memory block has a size of 1M. We recommend that you disable this option.

Passive Release:

Two options are available: Enabled and Disabled. Set the option to enabled or disabled passive release for the Intel PIIX4 chip (Intel PCI to ISA bridge). This function is used to meet the latency of the ISA bus master, if you have an ISA card compatibility problem, you can try to enable or disable this option for optimal result.

Delayed Transaction:

Two options are available: Enabled and Disabled. The default setting is *Disabled*. Set the option to enabled or disabled PCI 2.1 features including passive release and delayed transaction for the chipset. This function is used to meet the latency of PCI cycles to or from the ISA bus. This option must be enabled to provide PCI 2.1 compliance. If you have an ISA card compatibility problem, you can try to enable or disable this option for optimal results.

AGP Aperture Size (MB):

Seven options are available: 4 → 8 → 16 → 32 → 64 → 128 → 256 → Back to 4. This option specifies the amount of system memory that can be used by the AGP device. The aperture is a portion of the PCI memory address range dedicated for graphics memory address space.

SDRAM Leadoff Command

Two options are available: 3 and 4. This item lets you set the SDRAMs access speed. You can leave it on the default setting (3). If you want to adjust this item, you must check out your SDRAM SPD values first.

3-5. Integrated Peripherals

In this menu, you can change the onboard I/O device and other hardware peripheral settings.

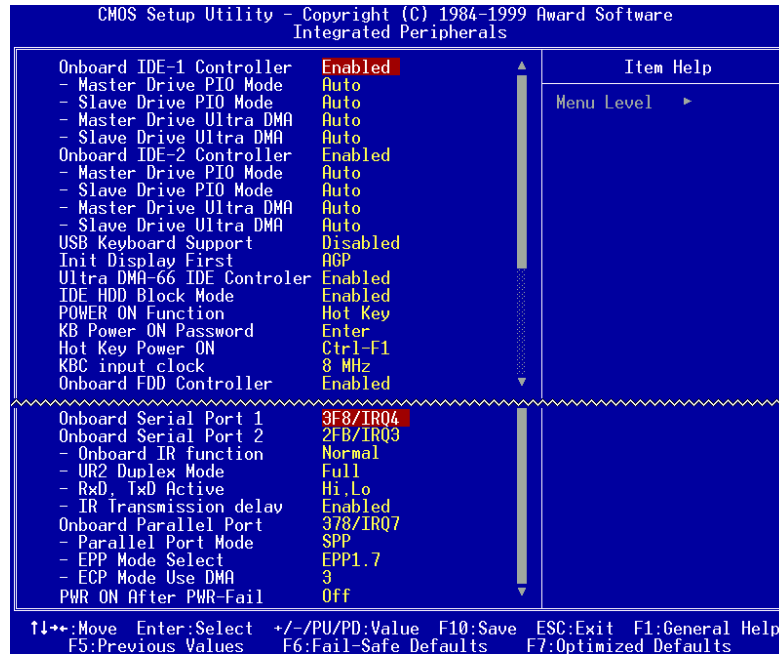

Figure 3-7. Integrated Peripherals Setup Screen Shot

Onboard IDE-1 Controller:

The onboard IDE 1 controller can be set as Enabled or Disabled. The default setting is *Enabled*. The integrated peripheral controller contains an IDE interface with support for two IDE channels. If you choose *Disabled*, it will effect the settings of four items not available. For example, if you disabled the *Onboard IDE-1 Controller*, you will also disable the *Master/Slave Drive PIO Mode* and *Master/Slave Drive Ultra DMA*.

Master/Slave Drive PIO Mode:

Six options are available: Auto → Mode 0 → Mode 1 → Mode 2 → Mode 3 → Mode 4 → Back to Auto. The four IDE PIO (Programmed Input/Output) items let you set a PIO mode (0-4) for each of the four IDE devices that the onboard IDE interface supports. Modes 0 through 4 provide successively increased performance. In Auto mode (default setting), the system automatically determines the best mode for each device.

— Master/Slave Drive Ultra DMA:

Two options are available: Auto and Disabled. The default setting is *Auto*. Ultra DMA is a DMA data transfer protocol that utilizes ATA commands and the ATA bus to allow DMA commands to transfer data at a maximum burst rate of 33 MB/sec.

Ultra DMA/33 or Ultra DMA/66 implementation is possible only if your IDE hard drive supports it and the operating environment includes a DMA driver (Windows® 95 OSR2 or a third-party IDE bus master driver).

- ▶ Auto: If your hard drive and your system software both support Ultra DMA/33, select *Auto* to enable BIOS support. For Ultra DMA/66 devices, please refer the requirements mentioned in page 2-18. (Default setting)
- ▶ Disabled: If you encounter a problem in using Ultra DMA devices, you can try to disable this item.

Onboard IDE-2 Controller:

Description is same as the *Onboard IDE-1 Controller*.

USB Keyboard Support:

Two options are available: Enabled and Disabled. The default setting is *Disabled*. If your system contains a USB keyboard, set it to *Enabled*.

Init Display First

This item allows you to decide to active whether PCI slot or AGP slot VGA first.

Ultra DMA-66 IDE Controller

This item allows you to Enable or Disable onboard Ultra DMA/66 controller. When you select Enabled, two additional channels provide the capability of adding high performance device(s) to the system.

IDE HDD Block Mode:

Block mode is also called block transfer, multiple commands, or multiple sector read/write. If your IDE hard drive supports block mode (most new drives do), select *Enabled* for automatic detection of the optimal number of block read/writes per sector the drive can support. The default setting is *Enabled*.

Power On Function:

This item allows you to select which way you want your system to power on. Five items are available: Button Only → Keyboard 98 → Password → Hot Key → Mouse Left → Mouse Right. Default setting is *Button Only*.

Note

- The power on function has to cooperate with the JP1 setting (see section 2-4).
- The mouse wake up function can only be used with the PS/2 mouse, not with a mouse that uses the COM port and USB connection. *Mouse Left (Mouse Right)* means, you need to double click the mouse *left (right)* button, for the computer to power on. You also need to note the compatibility issue with your PS/2 mouse. Some PS/2 mice cannot wake up the system, because of compatibility problems. Also, if the specs of your keyboard are too old, it may fail to power on.

— Keyboard 98:

If you are using Windows® 98 and you have a keyboard that is designed for the Windows® 98 operating system. You can enable this item, and use your keyboard wake up key to wake up your computer.

— KB Power ON Password:

If your *Power On Function* is set to *Password*, then you need to enter the password for keyboard wake up. When your computer is shutdown and you want to wake it up you only need to type the correct password, then you can power on.

— Hot Key Power On:

There are twelve options are available, Ctrl-F1 to Ctrl-F12. You can select this item and using the Ctrl plus the one of each function key (F1 to F12) to power on the computer. The default setting is *Ctrl-F1*.

KBC input clock

This item allows you to change the keyboard clock, if you have a keyboard problem, like keyboard failure, slow typing response time, etc. You may try to change the keyboard clock settings for optimal result.

Onboard FDD Controller:

Two options are available: Enabled and Disabled. The default setting is *Enabled*. You can enable or disable the onboard FDC controller.

Onboard Serial Port 1:

This is used to specify the I/O address and IRQ of Serial Port 1. Six options are available: Disabled → 3F8/IRQ4 → 2F8/IRQ3 → 3E8/IRQ4 → 2E8/IRQ3 → AUTO. The default setting is 3F8/IRQ4.

Onboard Serial Port 2:

This is used to specify the I/O address and IRQ of Serial Port 1. Six options are available: Disabled → 3F8/IRQ4 → 2F8/IRQ3 → 3E8/IRQ4 → 2E8/IRQ3 → AUTO. The default setting is 2F8/IRQ3.

Onboard Serial Port 1:

This is used to specify the I/O address and IRQ of Serial Port 1. Ten options are available: Disable, 3F8h/IRQ4, 2F8h/IRQ3, 3E8h/IRQ4 or 2E8h/IRQ3, 3F8h/IRQ10, 2F8h/IRQ11, 3E8h/IRQ10, 2E8h/IRQ11, and AUTO.

Onboard Serial Port 2:

This is used to specify the I/O address and IRQ of Serial Port 1. Ten options are available: Disable, 3F8h/IRQ4, 2F8h/IRQ3, 3E8h/IRQ4 or 2E8h/IRQ3, 3F8h/IRQ10, 2F8h/IRQ11, 3E8h/IRQ10, 2E8h/IRQ11, and AUTO.

— Onboard IR Function:

Three options are available:

- ▶ Normal
- ▶ IrDA (HPSIR) mode.
- ▶ ASK IR (Amplitude Shift Keyed IR) mode.

— UR2 Duplex Mode:

Two options are available: Full and Half. The default setting is *Full*. This item lets you choose the operation mode for your IR KIT. Some IR device only can work at half duplex mode. Refer to your IR KIT user's guide to find out which setting is correct.

— RxD , TxD Active:

Set IR transmission/reception polarity as High or Low.

— IR Transmission Delay:

Set IR transmission delays 4 character-time(40 bit-time) when SIR is changed from RX mode to TX mode.

Onboard Parallel Port:

Sets the I/O address and IRQ of the onboard parallel port. Four options are available: Disable, 3BCh/IRQ7, 278h/IRQ5 and 378h/IRQ7. Default is 378h/IRQ7.

— Parallel Port Mode:

Can be set as ECP, EPP, ECP+EPP, or Normal (SPP) mode. Default is Normal (SPP) mode.

— ECP Mode Use DMA:

When the mode selected for the onboard parallel port is ECP, the DMA channel selected can be Channel 1 or Channel 3.

— EPP Mode Select:

When the mode selected for the onboard parallel port is EPP, two EPP version options are available: EPP1.7 and EPP1.9.

PWR ON After PWR-Fail:

This setting lets you set the system action after a power failure. Three options are available: Off → On → Former-Sts. The default setting is *Off*.

NOTE

This function has to cooperate with the JP2 setting (see section 2-4).

3-6. Power Management Setup Menu

The difference between Green PCs and traditional computers is that Green PCs have a power management feature. With this feature, when the computer is powered on but inactive, the power consumption is reduced in order to save energy. When the computer operates normally, it is in Normal mode. In this mode, the Power Management Program will control access to video, parallel ports, serial ports and drives, and the operating status of the keyboard, mouse and other device. These are referred to as Power Management Events. If none of these events occur, the system enters the power saving mode. When one of the controlled events occurs, the system immediately returns to normal mode and operates at its maximum speed. Power saving modes can be divided into three modes according to their power consumption: Doze Mode, Standby Mode, and Suspend Mode. The four modes proceed in the following sequence:

Normal Mode ==> Doze Mode ==> Standby Mode ==> Suspend Mode



The system consumption is reduced according the following sequence:

Normal > Doze > Standby > Suspend

1. In the Main Menu, select "Power Management Setup" and press "Enter". The following screen is displayed:

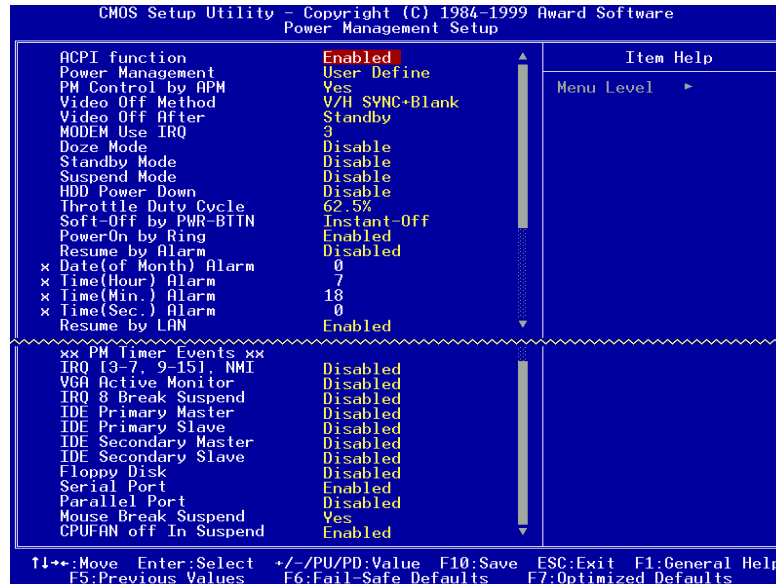

Figure 3-8. Power Management Setup Screen Shot

2. Use the arrow keys to go to the item you want to configure. To change the settings, use **↑**, **↓** and Enter key.
3. After you have configured the power management feature, press **Esc** to go back to the Main Menu.

We are now going to briefly explain the options in this menu:

ACPI Function (Advanced Configuration and Power Interface):

ACPI gives the operating system direct control over the power management and Plug and Play functions of a computer.

There are two options that can be selected, “Enabled” and “Disabled”. You can select “Enabled” to enable ACPI functions. If you want ACPI functions to work normally, you should notice two things. One is your operating system must support ACPI, as of now only Microsoft® Windows® 98 supports these functions. The second thing is that all devices and add-on cards in your system must fully support ACPI, both hardware and software (drivers). If you want to know if your devices or add-on cards support ACPI or not, please contact the device or add-on card manufacture for more information. If you want to know more about ACPI specifications, please go to the address below for more detailed information:

<http://www.teleport.com/~acpi/acpihtml/home.htm>

Note: If you enable the ACPI function in the BIOS setup, the SMI function will not work.

ACPI requires an ACPI-aware operating system. ACPI features include:

- Plug and Play (including bus and device enumeration) and APM functionality normally contained in the BIOS.
- Power management control of individual devices, add-in cards (some add-in cards may require an ACPI-aware driver), video displays, and hard disk drives.
- A Soft-off feature that enables the operating system to power off the computer.
- Support for multiple wake-up events (see Table 3-6-1).
- Support for a front panel power and sleep mode switch. Table 3-6-2 describes the system states based on how long the power switch is pressed, depending on how ACPI is configured with an ACPI-aware operating system.

Note

If you enable the ACPI function in the BIOS setup, the SMI switch function will not work.

System States and Power States

Under ACPI, the operating system directs all system and device power state transitions. The operating system puts devices in and out of low-power states based on user preferences and knowledge of how devices are being used by applications. Devices that are not being used can be turned off. The operating system uses information from applications and user settings to put the system as a whole into a low-power state.

Table 3-6-1: Wake Up Device and Events

The table below describes which devices or specific events can wake the computer from specific states.

These device/events can wake up the computer.....from this state
Power switch	Sleeping mode or power off mode
RTC alarm	Sleeping mode or power off mode
LAN	Sleeping mode or power off mode
Modem	Sleeping mode or power off mode
IR command	Sleeping mode
USB	Sleeping mode
PS/2 keyboard	Sleeping mode
PS/2 mouse	Sleeping mode

Table 3-6-2: Effect of Pressing the Power Switch

If the system is in this state.....and the power switch is pressed forthe system enters this state
Off	Less than four seconds	Power on
On	More than four seconds	Soft off/Suspend
On	Less than four seconds	Fail safe power off
Sleep	Less than four seconds	Wake up

Power Management:

This item allows you to select the type (or degree) of power saving and is directly related to the following modes:

1. Doze Mode
2. Standby Mode
3. Suspend Mode
4. HDD Power Down

There are three options for power management, three of which have fixed mode settings:

► User Define

“User Define” defines the delay for accessing the power modes.

Doze Mode: Disabled → 1 Min → 2 Min → 4 Min → 8 Min → 12 Min → 20 Min → 30 Min → 40 Min → 1 Hour. The default setting is *Disabled*.

Standby Mode: Disabled → 1 Min → 2 Min → 4 Min → 8 Min → 12 Min → 20 Min → 30 Min → 40 Min → 1 Hour. The default setting is *Disabled*.

Suspend Mode: Disabled → 1 Min → 2 Min → 4 Min → 8 Min → 12 Min → 20 Min → 30 Min → 40 Min → 1 Hour. The default setting is *Disabled*.

HDD Power Down: Disabled → 1 Min → 2 Min → 3 Min → 4 Min → 5 Min → 6 Min → 7 Min → 8 Min → 9 Hour → 10 Min → 11 Min → 12 Min → 13 Min → 14 Min → 15 Min. The default setting is *Disabled*.

► Min Saving

When these two saving modes are enabled, the system is set up for minimum power savings.

Doze Mode = 1 Hour

Standby Mode = 1 Hour

Suspend Mode = 1 Hour

HDD Power Down = 15 Min

► Max Saving

When the two saving modes are enabled, the system is set up for maximum power savings.

Doze Mode = 1 Min

Standby Mode = 1 Min

Suspend Mode = 1 Min

HDD Power Down = 1 Min

PM Control by APM:

Power Management is completely controlled by the APM.

APM stands for Advanced Power Management, it is a power management standard set by Microsoft, Intel and other major manufacturers.

Video Off Method:

Three video off methods are available: "Blank Screen", "V/H SYNC + Blank" and "DPMS". The default is " V/H SYNC + Blank ".

If this setting does not shut off the screen, select "Blank Screen". If your monitor and video card support DMPS standard, select "DPMS".

Blank Screen: This option only writes blanks to the video buffer.

V/H SYNC + Blank: This selection will cause the system to turn off the vertical and horizontal synchronization ports and write blanks to the video buffer.

DPMS: Initial display power management signaling.

Video Off After:

Select the saving mode in which the video is switched off.

- NA
The video will never be switched off in no power saving mode.
 - Suspend
The video will only be switched off in Suspend mode.
 - Standby
The video will only be switched off in Standby or Suspend mode.
 - Doze
The video will be switched off in all power saving modes.
-

Modem Use IRQ:

You can specify the IRQ for modem use. Eight options are available: N/A → 3 → 4 → 5 → 7 → 9 → 10 → 11. The default setting is N/A.

Doze Mode:

When the setting selected for "Power Management" is "User Define", you can define for this mode any delay from 1 minute to 1 hour. If no power management event occurs during this time period, meaning that the computer is inactive during this period, the system will enter the Doze power saving mode. If this mode is disabled, the system will enter the next mode in the sequence (Standby or Suspend mode).

Standby Mode:

When the setting selected for "Power Management" is "User Define", you can define for this mode any delay from 1 minute to 1 hour. If no power management event occurs during this time period, meaning the computer is inactive during this period, the system will enter the Standby power saving mode.

If this mode is disabled, the system will enter the next mode in the sequence (Suspend mode).

Suspend Mode:

When the setting selected for "Power Management" is "User Define", you can define for this mode any delay from 1 minute to 1 hour. If no power management event occurs during this time period, meaning the computer is inactive during this period, the system will enter the Suspend power saving mode. The CPU stops working completely.

If this mode is disabled, the system will not enter the Suspend mode.

HDD Power Down:

If the system has not accessed data on the hard disk drive during the specified time period, the engine of the HDD will stop in order to save electricity. You can set 1 to 15 minutes or select Disable according to your use of the HDD.

Throttle Duty Cycle:

This is used to specify the CPU speed in power saving mode. Six options are available: 12.5%, 25.0%, 37.5%, 50.0%, 62.5% or 75.0%.

Soft-Off by PWR-BTTN:

Two options are available: Instant-Off and Delay 4 Sec.. The default setting is *Instant-Off*. Pressing the power button for more than four seconds forces the system to enter the Soft-Off state when the system has "hung".

Power On by Ring:

Two options are available: Enabled and Disabled. Default setting is *Disabled*. If you connect an external modem to the onboard serial port, the system will be turned on when a telephone ring-up occurs.

Resume by Alarm:

Two options are available: Enabled and Disabled. Default setting is *Disabled*. The RTC alarm can turn on the system. You can set Date (of month) and Time (hour, minute, and second) when you set this item to *Enabled*.

Resume by LAN:

Two options are available: Enabled and Disabled. When select *Enabled*, an input signal from a local area network (LAN) awakens the system from a soft off state.

PM Timer Events:

When one of the specified events occur, the count down made for entry in power saving mode goes back to zero. Since the computer will enter a power saving mode only after an inactivity delay specified (time specific for Doze, Standby and Suspend modes) and after it has no activity, during this time period, any event will cause the computer to re-count the time elapsed. Resume events are operations or signals that cause the computer to resume time counting.

➤ **IRQ [3-7, 9-15], NMI:**

If any IRQ or NMI (Non-Mask Interrupt) activities occur, this will cause the computer to re-count the time elapsed.

➤ **VGA Active Monitor:**

If there is any VGA data transfer or any I/O activities, this will cause the computer to re-count the time elapsed.

➤ **IRQ8 Break Suspend:**

Supports the RTC alarm wake up from suspend function (via IRQ8).

➤ **IDE Primary Master:**

If any IDE primary master I/O activity occurs, it will cause the computer to re-count the time elapsed.

➤ **IDE Primary Slave:**

If any IDE primary slave I/O activity occurs, it will cause the computer to re-count the time elapsed.

➤ **IDE Secondary Master:**

If any IDE secondary master I/O activity occurs, it will cause the computer to re-count the time elapsed.

➤ **IDE Secondary Slave:**

If any IDE secondary slave I/O activity occurs, it will cause the computer to re-count the time elapsed.

► **Floppy Disk:**

If any floppy disk I/O activity occurs, it will cause the computer to re-count the time elapsed.

► **Serial Port:**

If any serial port I/O activity occurs, it will cause the computer to re-count the time elapsed.

► **Parallel Port:**

If any Parallel port I/O activity occurs, it will cause the computer to re-count the time elapsed.

► **Mouse Break Suspend:**

Four options are available: Yes → No (COM1) → No (COM2) → No (PS/2) → **Back to Yes.**

CPU FAN Off In Suspend

Two options are available: Enabled and Disabled. When select Enabled the CPU fan turns off during Suspend mode

3-7. PnP/PCI Configurations

This section describes configuring the PCI bus system. PCI, or **P**ersonal **C**omputer **I**nterconnect, is a system which allows I/O devices to operate at speeds nearing the speed the CPU itself uses when communicating with its own special components. This section covers some very technical items and it is strongly recommended that only experienced users should make any changes to the default settings.

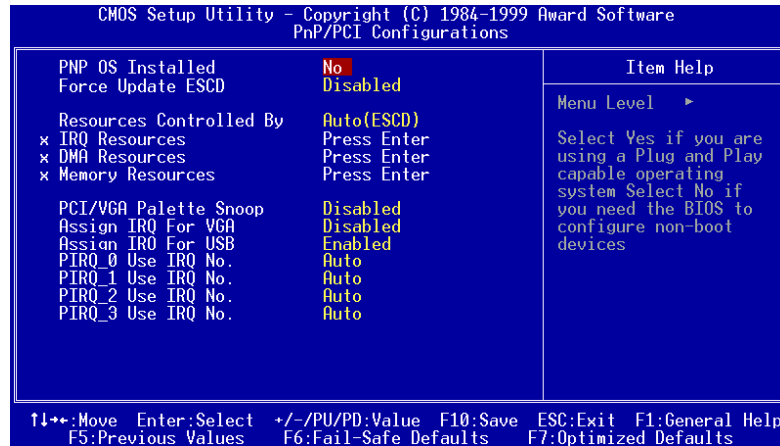

Figure 3-9. PnP/PCI Configurations Setup Screen Shot

PNP OS Installed:

The device resource assigned by PnP OS (e.g., Windows 95) or BIOS.

Force Update ESCD

Two options are available: Enabled and Disabled. Default setting is *Disabled*. Normally, you leave this field *Disabled*. Select *Enabled* to reset Extended System Configuration Data (ESCD) when you exit Setup if you have installed a new add-on card and the system reconfiguration has caused a resource conflict that the operating system can not boot.

Resources Controlled By:

Two options are available: Auto(ESCD) and Manual. Default setting is *Auto(ESCD)*. When the setting is Auto(ESCD), the *IRQ Resources* and *Memory Resources* can not be changed

manually. When resources are controlled manually, the *IRQ Resources*, *DMA Resources* and *Memory Resources* can then be changed.

Computer Knowledge: ESCD (Extended System Configuration Data)

The ESCD contains the IRQ, DMA, I/O port, memory information of the system. This is a specification and a feature specific to the Plug & Play BIOS.

Legacy ISA devices compliant with the original PC AT bus specification, requiring a specific interrupt (such as IRQ4 for serial port 1).

PCI/ISA PnP devices compliant with the Plug and Play standard, whether designed for the PCI or ISA bus architecture.

The Award Plug and Play BIOS has the capability to automatically configure all of the boot and PnP compatible devices. If you select *Auto (ESCD)*, The IRQ, DMA and Memory Resources items will be disabled, as the BIOS automatically assigns them. But if you have trouble in assigning the interrupt resources automatically, you can select *Manual* to set which IRQ and DMA are assigned to PCI/ISA PnP or legacy ISA cards.

IRQ Resources

When resources are controlled manually, assign each system interrupt a type, depending on the type of device using the interrupt.

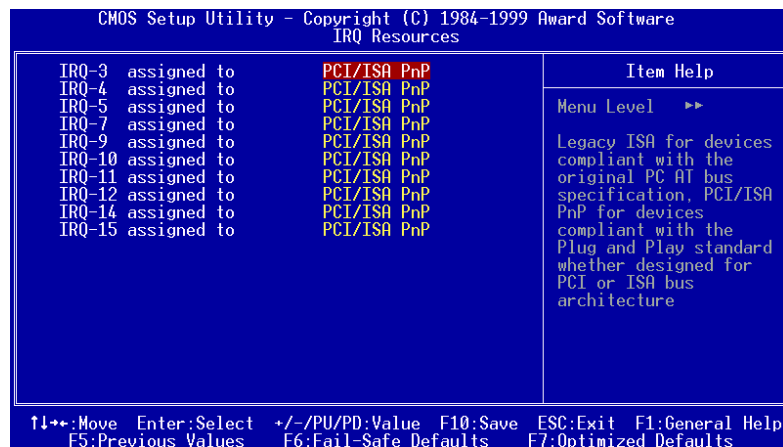

Figure 3-10. PnP/PCI Configurations - IRQ Resources Setup Screen Shot

📁 DMA Resources

When resources are controlled manually, assign each system DMA channel a type, depending on the type of device using the DMA channel.

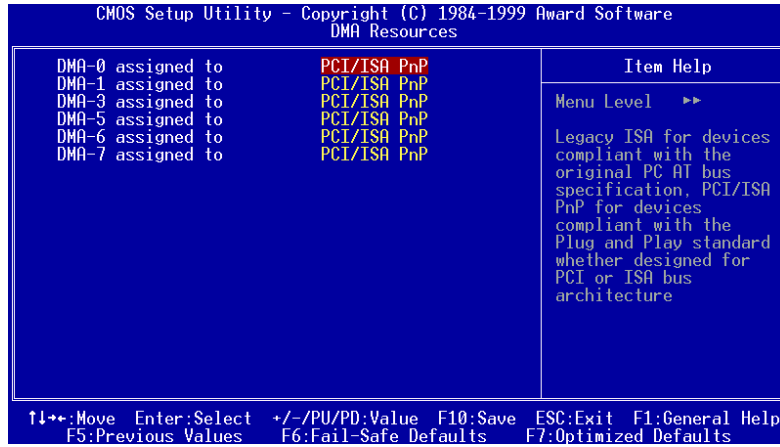

Figure 3-11. PnP/PCI Configurations - DMA Resources Setup Screen Shot

📁 Memory Resources

This sub menu can let you control the memory resource.

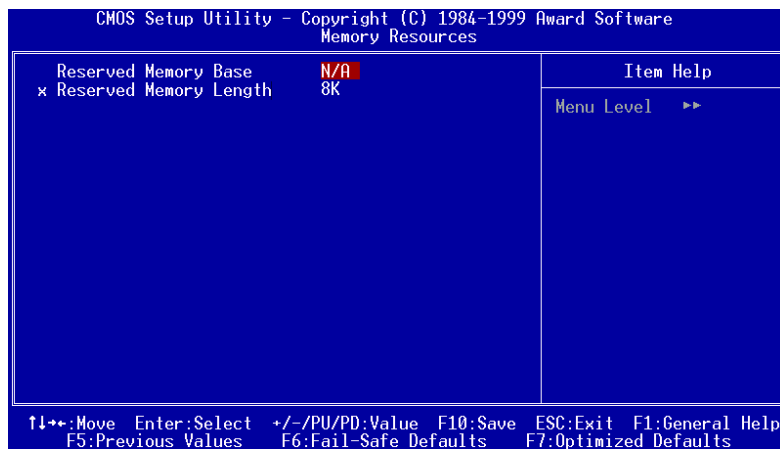

Figure 3-12. PnP/PCI Configurations - Memory Resources Setup Screen Shot

► Reserved Memory Base

Reserved a low memory for the legacy device (non-PnP device). Seven options are available: N/A, C800, CC00, D000, D400, D800 and DC00.

► Reserved Memory Length

Reserved a low memory length for the legacy device (non-PnP device). Four options are available: 8K, 16K, 32K and 64K.

PCI /VGA Palette Snoop:

This option allows the BIOS to preview VGA Status, and to modify the information delivered from the Feature Connector of the VGA card to the MPEG Card. This option can solve the display inversion to black after you have used the MPEG card.

Assign IRQ For VGA :

You can assign an IRQ for the PCI VGA or *Disabled*.

Assign IRQ For USB

You can select enabled if your system has a USB controller and you have one or more USB devices connected. If you are not using your system USB controller, you can select Disabled to free the IRQ resource.

PIRQ 0~3 Use IRQ No.

Eleven options are available: Auto, 3, 4, 5, 7, 9, 10, 11, 12, 14, 15. Default setting is *Auto*. This item allows the system to automatically specify the IRQ number for the device installed on PCI slots. Which means, the system can specify the fixed IRQ number for the device installed on the PCI slots (PCI slot 1 to PCI slot 5). This is a useful function when you want to fix the IRQ for a specific device.

For example, if you want to move your hard disk to another computer and don't want to re-install Windows® NT, then you can specify the IRQ for the device installed on the new computer to fit the original computer settings.

Note

If you specify the IRQ in this item, then you cannot specify the same IRQ to the ISA bus, otherwise, it will cause a hardware conflict.

This feature is for the operating system which will record and fix the PCI configuration status, if you want to change it.

For the relations between the hardware layout of PIRQ (the signals from the PIIX4 chipset), INT# (means PCI slot IRQ signals) and devices, please refer to the table below:

Signals	PCI slot 1 AGP Slot	PCI slot 2	PCI slot 3	PCI slot 4	PCI slot 5	HPT 366
PIRQ_0	INT A	INT B	INT C	INT D	INT B	INT C
PIRQ_1	INT B	INT D	INT D	INT A	INT A	INT D
PIRQ_2	INT C	INT C	INT A	INT B	INT D	INT A
PIRQ_3	INT D	INT A	INT B	INT C	INT C	INT B

- Each PCI slot has four INT#s (INT A~INT D), and the AGP slot has two INT# (INTA and INTB).
- USB used PIRQ_3.

Note

- PCI slot 5 and HPT 366 IDE controller uses the same bus master control signals, therefore; if the HPT 366 IDE controller (see section 3-5) is enabled, you can't install a PCI card that will occupy the bus master signals into PCI slot 5. What kind of PCI card needs to use the bus master signal? Generally speaking, most of the PCI cards need to use the bus master signal, but some Add-on cards such as the Voodoo series of graphics cards and some PCI-VGA and LAN cards don't occupy the bus master signal.
- PCI slot 3 shares IRQ signals with the HPT366 IDE controller (Ultra ATA/66). The driver for HPT 366 IDE controller supports IRQ sharing with other PCI devices. But if you install a PCI card that doesn't allow IRQ sharing with other devices into PCI slot 3, you may encounter some problems. Furthermore, if your Operating System doesn't allow peripheral devices to share IRQ signals with each other--Windows NT for example, you can't install a PCI card into PCI slot 3.
- PCI slot 1 shares IRQ signals with the AGP slot.
- PCI slot 2 shares IRQ signals with the PCI slot 5
- If you want to install two PCI cards into those PCI slots that share IRQ with one another at the same time, you must make sure that your OS and PCI devices' driver support IRQ sharing.

3-8. PC Health Status

You can set the warning and shutdown temperatures for your computer system, and you can check the fan speeds and power supply voltages of your computer system. The features are useful for monitoring all the important parameters within your computer system. We call it the *PC Health Status*.

CMOS Setup Utility - Copyright (C) 1984-1999 Award Software		Item Help
PC Health Status		Menu Level ▶
Shutdown Temperature	75°C/167°F	
CPU Warning Temperature	70°C/158°F	
System Temperature 1	43 C/109 F	
System Temperature 2	0 C/ 32 F	
CPU Temperature	60 C/140 F	
CPU Fan (Fan 1) Speed	4500 RPM	
Power Fan (Fan 2) Speed	4300 RPM	
CPU Core Voltage	1.98V	
VTT (+1.5V)	1.53V	
I/O Voltage (+3.3V)	3.39V	
+ 5 V	5.05V	
+12 V	12.16V	
-12 V	- 12.28V	
- 5 V	- 4.99V	
VCC25 (+2.5V)	2.48V	
Standby Voltage (+5V)	5.05V	

↑↓←→:Move Enter:Select +/-/PU/PD:Value F10:Save ESC:Exit F1:General Help
F5:Previous Values F6:Fail-Safe Defaults F7:Optimized Defaults

Figure 3-13. PC Health Status Screen Shot

Shutdown Temperature

This item lets you select the limit for the system shutdown temperature. If the temperature extends beyond the limit, the system will shut down. The default setting is 75°C / 167°F.

CPU Warning Temperature:

This item lets you select the temperature at which you want the system to send out a warning message to the PC speakers of when the temperature goes beyond either limit. You can select the temperatures you want. The ranges are from 30°C / 86°F to 120°C / 248°F, default setting is 70°C / 158°F.

All Voltages, Fans Speed and Thermal Monitoring:

These items list the current states of the CPU and environment temperatures as well as fan speeds (CPU fan and chassis fan). It can not be changed by the user.

The following items list the voltage states of the system power. It is also unchangeable.

3-9. Load Fail-Safe Defaults

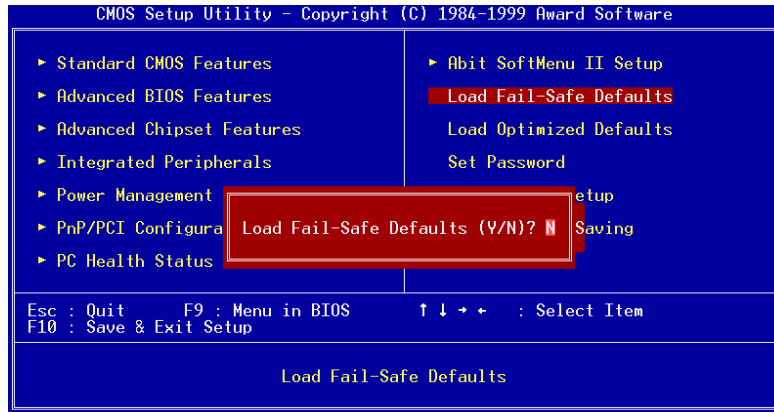

Figure 3-14. Load Fail-Safe Defaults Screen Shot

When you press <Enter> on this item you get a confirmation dialog box with a message similar to:

Load Fail-Safe Defaults (Y/N) ? **N**

Pressing 'Y' loads the BIOS default values for the most stable, minimal-performance system operations.

3-10. Load Optimized Defaults

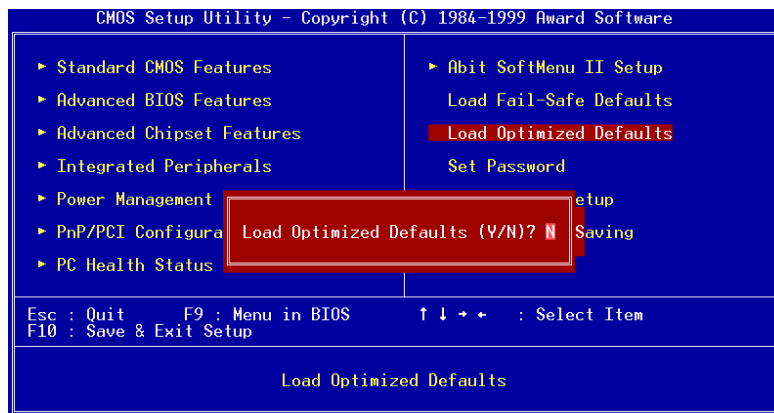

Figure 3-15. Load Optimized Defaults Screen Shot

When you press <Enter> on this item you get a confirmation dialog box with a message similar to:

Load Optimized Defaults (Y/N)? N

Pressing 'Y' loads the default values that are factory settings for optimal performance system operations.

3-11. Set Password

This option allows you to set a password required to start the system (System) or to access to the BIOS (Setup).

After you have set a password through the **Set Password** option, you can enter the "**Advanced BIOS Features**" (refer to 3-3) to set the "**Security Option**". In this way, you can prevent unauthorized access.

Password setting procedure:

When you choose the **Set Password** option, the following message is displayed:

"Enter Password:"

Type your password. When complete, press <Enter>. The following message is displayed:

"Confirm Password:"

Type your password again. When complete, press <Enter>. The password setting is completed.

Password clearing procedure:

When you select the **Set Password** option, the following message is displayed:

"Enter Password:"

Press <Enter>, the message "**Password Disabled !!!**" is displayed. Press a key. The password clearing procedure is completed.

Notice

Do not forget your password. If you forget it, you will have to open the computer case, clear the contents of the CMOS, and boot the system up again. By doing this, you must reset all your parameters.
--

3-12. Save & Exit Setup

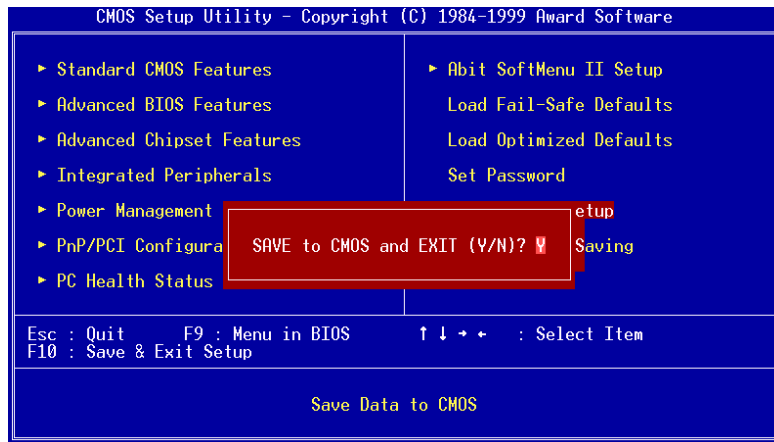

Figure 3-16. Save & Exit Setup Screen Shot

Pressing <Enter> on this item asks for confirmation:

Save to CMOS and EXIT (Y/N)? Y

Pressing “Y” stores the selections made in the menus in CMOS - a special section of memory that stays on after you turn your system off. The next time you boot your computer, the BIOS configures your system according to the Setup selections stored in CMOS. After saving the values the system is restarted again.

3-13. Exit Without Saving

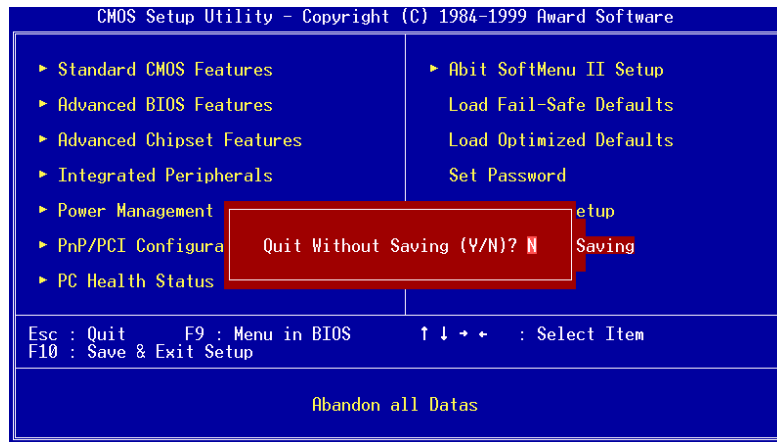

Figure 3-17. Exit Without Saving Screen Shot

Pressing <Enter> on this item asks for confirmation:

Quit without saving (Y/N)? Y

This allows you to exit Setup without storing in CMOS any change. The previous selections remain in effect. This exits the Setup utility and restarts your computer.

Appendix A BIOS Flashing User Instructions

When your motherboard needs to be upgraded with new features or some compatibility problems in the BIOS need to be fixed, you will need to use this BIOS flash utility. This utility is provided by Award Software makes it easy to flash by yourself. However, please read all the information in this section before flashing.

Before you can flash the BIOS you need to go into the *pure DOS environment* by rebooting your system and going directly into DOS. Basically, there are two ways to flash your BIOS. One is to directly type the full line commands that are described in this section. The utility will then flash your BIOS. When you finish the flash operation, you will see the screen as in Figure F-2 ^{Note F-1}.

The other method is to just type *awdflash* (under Award flash BIOS utility directory) then press enter. The Flash Memory Writer V7.22 screen will appear. Please refer to Figure F-1 ^{Note F-1}. You need to type "NEWBIOS" (the file name or you can use another name if you choose) into the "File Name to Program", then press enter.



```
FLASH MEMORY WRITER V7.22
(C)Award Software 1999 All Rights Reserved
For i440BX-W977-2A69KA1JC-M   DATE: 07/13/1999
Flash Type -
File Name to Program : BE6-II.bin
Error Message:
```

Figure F-1. Award Flash Memory Writer V7.22 Start Screen

When you have finished updating your BIOS, you will see the screen as in Figure F-2. You then need to press the *F1* key to reset the system, or press the *F10* key to exit the writer.

```

FLASH MEMORY WRITER V7.22
(C)Award Software 1999 All Rights Reserved

For i440BX-W977-2A69KA1JC-M   DATE: 07/13/1999
Flash Type -

File Name to Program : BE6-II.bin
Checksum: 69B4H
Erase Flash Memory - 7FE000K

Write OK   No Update   Write Fail

F1  Reset  F10  Exit

```

Figure F-2. Award Flash Memory Writer V7.22 Complete Screen

Figure F-3 shows you what commands you can use for the flashing program. You need to go into the pure DOS environment and type *awdf flash*. Figure F-3 will then appear.

```

Awdf flash 7.22 (C)Award Software 1999 All Rights Reserved
Usage: AWDFLASH [FileName1] [FileName2] [/<sw>[/<sw>...]]
      FileName1 : New BIOS Name For Flash Programming
      FileName2 : BIOS File For Backing-up the Original BIOS
<Switches>
? : Show Help Messages
py: Program Flash Memory           pn: No Flash Programming
sy: Backup Original BIOS To Disk File  sn: No Original BIOS Backup
sb: Skip BootBlock programming       sd: Save DMI data to file
cp: Clear PnP(ESCD) Data After Programming
cd: Clear DMI Data After Programming
cc: Clear CMOS Data After Programming
R : RESET System After Programming   cks: Show update Binfile checksum
Tiny: Occupy lesser memory
E : Return to DOS When Programming is done
F : Use Flash Routines in Original BIOS For Flash Programming
LD: Destroy CHOS Checksum And No System Halt For First Reboot
    After Programming
cksXXXX: Compare Binfile CheckSum with XXXX
Example: AWDFLASH 2a59i000.bin /py/sn/cd/cp/cks2635

```

Figure F-3. Award Flash Memory Writer V7.22 Flash Commands Screen

Note F-1

The BIOS file name in the figure shown is only an example. You should check which .bin file is to be used with your motherboard. Don't flash with the wrong .bin file otherwise you may cause system malfunctions. Even the same model BIOS, according to their release dates and which problems have been fixed, have different .bin names. Please read the BIOS file description before you download it.

Example 1: To update the BIOS and create a backup of the current system BIOS execute this command:

```
AWDFLASH NEWBIOS /PY SAVEBIOS /SY
```

Example 2: To update the BIOS, create a backup of current system BIOS, and clear the CMOS, execute this command:

```
AWDFLASH NEWBIOS SAVEBIOS /CC
```

Example 3: To update the BIOS and clear PnP settings execute this command:

```
AWDFLASH NEWBIOS /SN /CP
```

Example 4: To make a backup of the current system BIOS execute the following command:

```
AWDFLASH NEWBIOS /PN SAVEBIOS
```

Note F-2

“NEWBIOS” indicates the file name for the new BIOS which can be downloaded from our web site at <http://www.abit.com.tw> (the user can choose a different file name in place of NEWBIOS). “SAVEBIOS” indicates the filename of the old system BIOS (the user can choose a different file name in place of SAVEBIOS).

Explanation of parameter names:

/CC: Clears CMOS data

/CP: Clears PnP data

/CD: Clears DMI data

/CKS: Compare Binfile Checksum

Remarks:

1. When executing AWDFLASH.EXE, do not run HIMEM.SYS and EMM386.EXE in the CONFIG.SYS.
2. Please take the following actions to solve problems caused by power shortages or other non-preventable malfunctions during BIOS updating that lead to update failures. First, it is strongly suggested that you format a disk that can boot your computer before you update your BIOS. If the above mentioned problem occurs during BIOS updating, you will be able to use this disk to automatically execute a BIOS update. The content of the disk should be as follows:

(1) Startup system files (COMMAND.COM, MSDOS.SYS, IO.SYS...)

(2) AWDFLASH.EXE

(3) The NEWBIOS file which can be download from ABIT web site.

(4) AUTOEXEC.BAT, which has the following content:

A:\AWDFLASH NEWBIOS /PY /SN /CC /CD

For example, to update the BE6-II BIOS version to MJ (BE6-IL_MJ.BIN), you need to type:

A:\AWDFLASH BE6-II_MJ.BIN /PY /SN /CC /CD /CKS

3. If you try to flash an incorrect version of a BIOS (i.e. for another motherboard) the following message will appear:

“The program file’s part number does not match with your system!”

Note

Please do not use the Award flash flash memory writer version that earlier than Version 7.22 to flash your WX6 motherboard BIOS. Otherwise, it may cause flash fail or anticipate problems.

Appendix B Installing the HighPoint XStore Pro Utility

We provide a useful and powerful utility in our product package, *HighPoint XStore Pro*. What does XStore do? The XStore Pro is a hard disk enhancement utility which can improve system performance. The basic concept is using a read-ahead caching algorithm to improve the hard disk performance. With a market trend where most system's standard configurations are moving towards 48 MBytes memory size or beyond, HighPoint's XStore Pro provides higher system performance. XStore Pro is a new generation of XStore MMX Accelerator for Storage.

XStore Pro utilizes the bigger system memory size to enhance memory management by working with Windows® 95 and 98. XStore Pro optimizes higher system performance by read ahead caching after seeking, with large block sizes of hard disks. And best of all, XStore Pro supports several PCI Bus Master Controllers such as Intel, SiS, Ali, Via and others.

When you install XStore Pro, you can choose to install CD Xpress at the same time. Why do you need CD Xpress? We'll tell you more about it.

CD-ROM technology is growing fast, but its performance is still unacceptable compared to today's hard drives. The transfer rates of today's hard drives can exceed 18MB/sec with access times below 12ms. However, transfer rates for the fastest CD-ROM drives on the market are below 2MB/sec with access times over 100 ms.

CD Xpress was created to accelerate the accessing speed of the CD-ROM drive by utilizing the hard drive's high performance. CD Xpress reads and buffers data from the CD-ROM to an area in the hard drive. With CD Xpress, when you access CD-ROM data, you are actually accessing data from a swap file in the hard drive. This results in a tremendous increase in CD-ROM performance without penalties.

Before you install this utility, there are several things you need to know.

Important Note

1. You can only install one Bus Master Driver at a time in your system, or the drivers will result in conflict and cause system hangs. Please make sure you don't have any Bus Master Driver installed in your system before you install XStore Pro! You must remove all components of the previous Bus Master Driver before you install XStore Pro to your system. For example, you cannot install both the Intel® bus master driver and HighPoint

XStore Pro in your system, otherwise it will cause system conflict when you install the second bus master driver!

2. This Windows® 95/98 driver does not support CD-ROM Changers. If you have an ATAPI CD-ROM Changer installed in your system, please do not install this driver!
3. We have found that the Windows® 95 OSR2/Windows® 98 version would fail to load the driver on some systems using the Bus Master chipset after you install and restart the system. The following step could solve this problem if it happens:
 - (1) Go to My Computer and double click Control Panel.
 - (2) Double click System then go to Device Manger and View Devices by Type.
 - (3) Go to hard disk controllers.
 - (4) Double click PCI Bus Master IDE Controller (Ultra DMA supported). (There should be a yellow mark besides this item)
 - (5) Click Resources and you should see a box near the bottom of the screen that says "Set Configuration Manually".
 - (6) Click on "Set Configuration Manually" and you will see a check next to "Use automatic setting".
 - (7) Uncheck the box and when the system asks you to reboot click "yes".
 - (8) After the system restarts the yellow mark should be gone

4. De-Installation:

To uninstall XStore Pro from your system, run "Uninstall" from the HighPoint XStore Pro program group. This uninstall utility will: deactivate CD Xpress, if CD Xpress is active, remove the buffer space, and uninstall XStore Pro and CD Xpress from the system. After uninstalling XStore Pro, the hard disk will return to its original status. We suggest users to reboot the system after finishing uninstalling.

5. The ATAPI LS-120 device will be recognized as a removable device in retail Windows 95(4.00.95) and OSR1 Windows 95(4.00.95 A) after the XStore Pro driver is installed.
6. This driver might lock on certain motherboards. Please check HighPoint Technology first if you encounter problems.

For more detailed information, please check the read me file stored in the *XStore Pro Program Group*. If you want to upgrade to a new version of driver or want to know more about XStore Pro products, please go to the HighPoint Technologies Inc's company WEB site, the URL is <http://www.highpoint-tech.com/>.

This CD-ROM (Or floppy diskette) has the HighPoint XStore Pro drivers. (Version 1.2) The following procedure describes how to install the HighPoint XStore to your system. If you have a floppy diskette but not the CD-ROM, just insert the diskette and run the **Setup.exe** file to start installation.

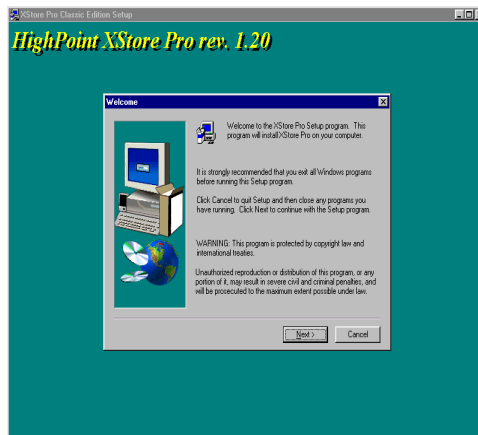

Step 1: In Windows® 95/98, place the CD-ROM into the computer. The main menu will show up. Click the **HighPoint XStore Pro Install** button, then you will see the XStore Pro installer is preparing the InstallShield® Wizard. When it is done, the *Welcome* screen will show up.

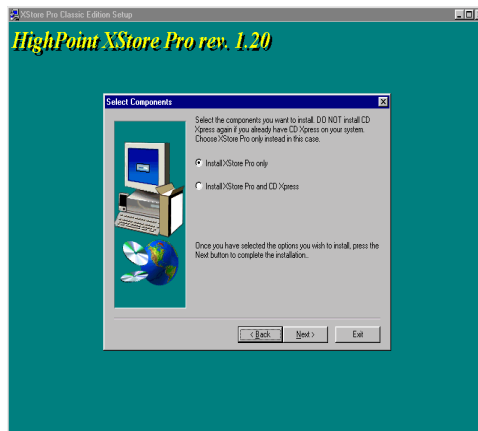

Step 2: Press the “Next” key, you will see the screen below. You then need to choose whether you want to install XStore Pro only, or if you want to install both XStore Pro and CD Xpress. Press the “Next” key to continue.

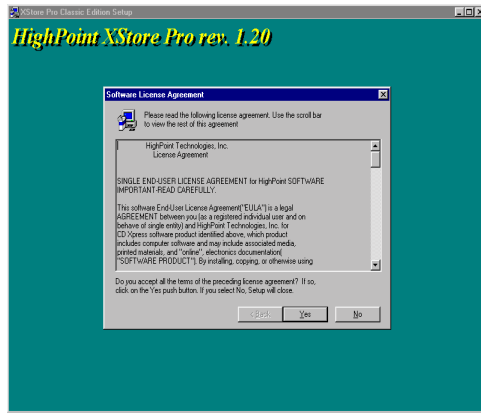

Step 3: Press the "Next" key, you will see the license screen.

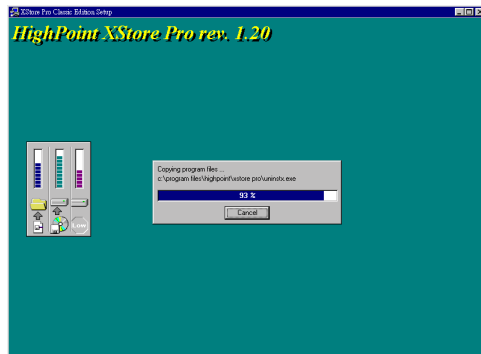

Step 4: Press "Yes" to the continue screen below.



Step 5: When installation process is done, you will see the screen below. This screen will show up only when you install both XStore Pro and CD Xpress. If you want to see the ReadMe file, you can click on the circle.

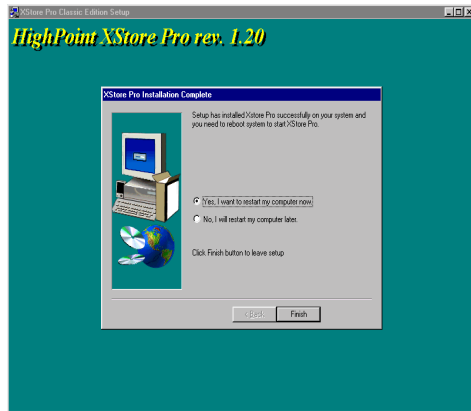

Step 6: Choose the “Yes, I want to restart my computer now.” button, then system will restart. Or you can choose the “No, I will restart my computer later.”.

Note

You must restart your computer after you installed the XStore Pro utility. Otherwise, software may work not properly.

Appendix C Hardware Monitoring Function (Installing The Winbond Hardware Doctor Utility)

Winbond Hardware Doctor is a self-diagnostic system for PCs and must be used with the Winbond chipset: W83781D/W83782D/W83783S IC series products.

It will protect PC hardware by monitoring several critical items including power supply voltages, CPU & system fan speeds, and CPU and system temperatures. These items are important for the operation of the system, errors may result in permanent damage of the PC. Once any item is out of its normal range, a warning message will pop up and remind the user to take proper measures.

The following description will tell you how to install the Hardware Doctor and use it. This CD-ROM (Or floppy diskette) has the Winbond Hardware Doctor utility. If you have a floppy diskette and not the CD-ROM, just insert diskette 1 and execute the **Setup.exe** file to start installation.

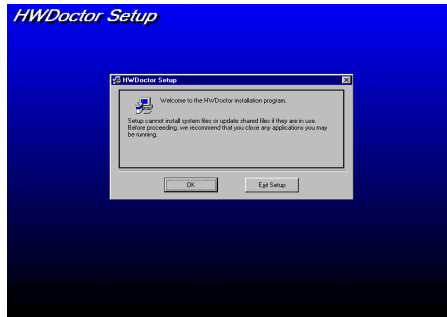

Step 1. In Windows® 95/98, place the CD-ROM into the computer. The main menu will show up. Click the **Hardware Doctor Install** button, then the *HWDoctor Setup* screen will show up, please refer the to figure below.



Step 2. Click the “OK” button, then see the screen below.

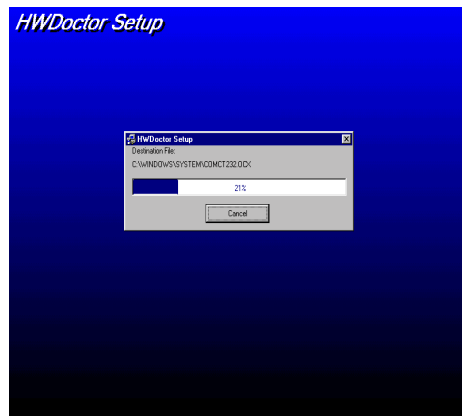

Step 3. You can specify the program install path by clicking “Change Directory” button. Or if you want to use the default path, click the  icon to continue the install process. Now the screen will show you the percentage of installation progress.

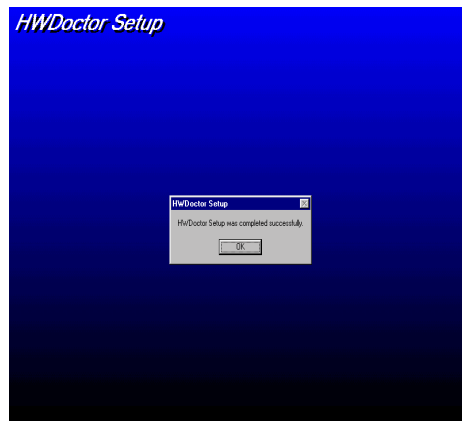

Step 4. When the progress finishes, click the “OK” button.

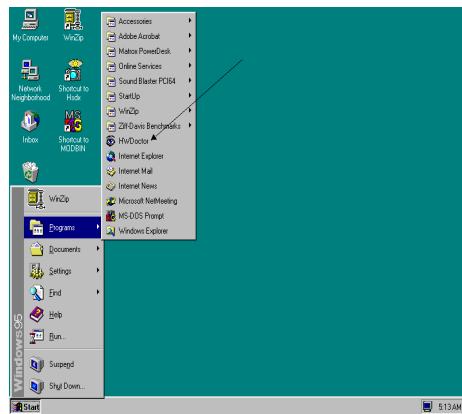

Step 5. Go to the Windows toolbar and click the “Start” button, then choose the “program” → “HWDoctor” (See the arrow mark on figure below).

Once any item is out of its normal range, a warning message will pop up.

The figure below shows the warning message windows.

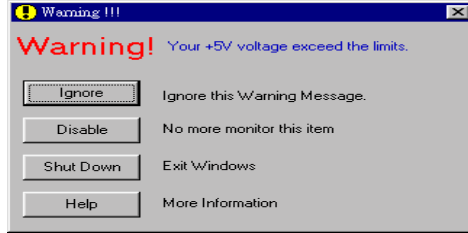

Ignore: You can ignore the warning message of the item this time, but it will still pop up when the error of the same item happens again.

Disable: The chosen item will be no longer monitored thereafter, unless you activate it in the "Configuration" page.

Shutdown: Choosing this button will shutdown the computer..

Help: You can read more information and self-diagnose simple problems.

If the warning message pops up due to the wrong warning limit, you can adjust it in the "Configuration" option. For example if you set the temperature high limit to 40°C, you are easy to exceed proper temperature.

Please pay attention to two things when you want to make any changes in the "Configuration" option. Firstly, you have to make sure your new setting is in the proper range. Secondly, after you finished the configuration, you have to save it. Otherwise, the program will start with the default value the next time.

If you meet any problems or have any questions about the software settings and adjustments, please use the Winbond hardware doctor on-line help, it should give you enough information to answer your questions.

Appendix D Installing the driver for Ultra ATA/66

In this section we will detail the Ultra ATA/66 driver installation procedure when used with various operating systems.

DOS

The Ultra ATA/66 BIOS supports DOS 5.x (or above) and Windows 3.1x without software driver.

Windows 95

Step 1: Install Windows 95 normally.

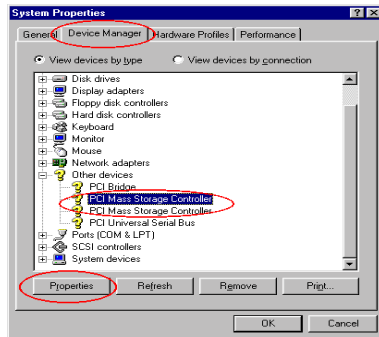

Step 2: After you have finished installation and entered Windows 95, please enter “Control Panel” → “System”, and then select “Device Manager” → “Other Devices.”

Select one of the “PCI Mass Storage Controllers” and then click “Properties.”

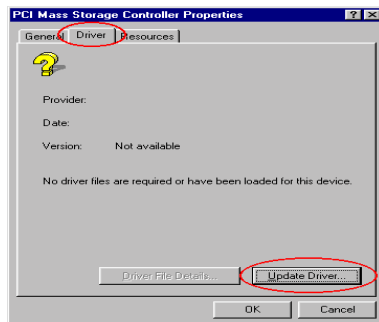

Step 3: Select “Driver” and then click “Update Driver.”



Step 4: Select “*Yes (Recommended)*” and then click “*Next.*”

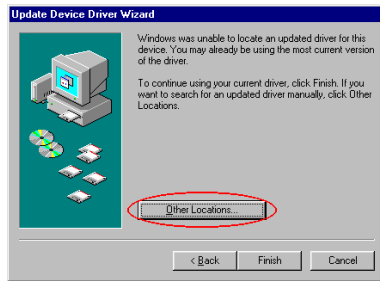

Step 5: Insert the Ultra ATA/66 driver disk into drive A, and then click “*Other Locations...*”

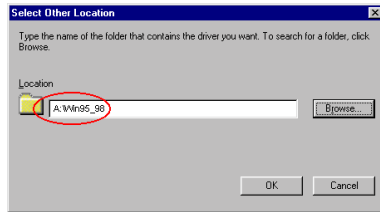

Step 6: Enter “*A:\Win95_98*” in blank space, and then click “*OK.*”

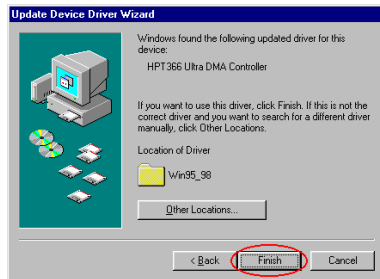

Step 7: Click “*Finish.*”

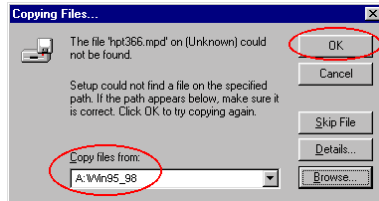

Step 8: Type "A:\Win95_98" in the "Copy files from:" text box, and then click "OK."

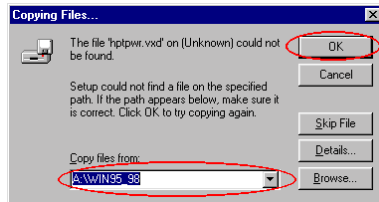

Step 9: Select "A:\Win95_98", and then click "OK."

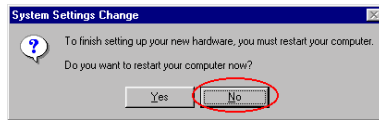

Step 10: Click "No" to continue updating another "PCI Mass Storage Controller" driver. The installation procedure is the same as Steps 3 to 10. After updating another controller driver, the system will ask you to restart your computer again. Click "Yes" to restart your computer.

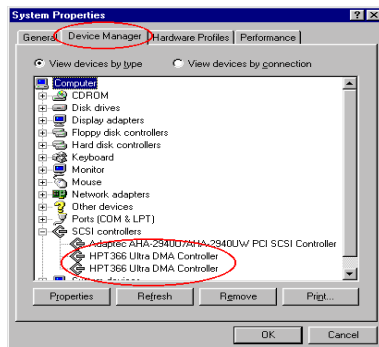

Step 11: After your system has restarted, you can enter "Control Panel" → "System", and then select "Device Manager" → "SCSI Controllers". If Ultra ATA/66 driver is installed correctly, you will see the figure on the left.

Windows 98

Step 1: Install Windows 98 normally.

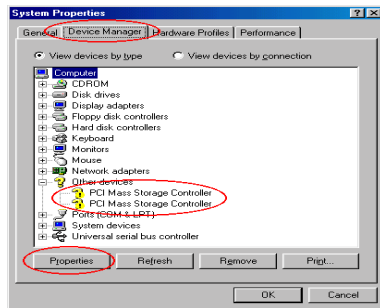

Step 2: After you have finished installation and entered Windows 95, please enter “Control Panel” → “System”, and then select “Device Manager” → “Other Devices.”

Select one of the “PCI Mass Storage Controllers” and then click “Properties.”

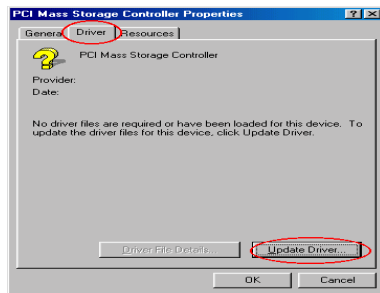

Step 3: Select “Driver” and then click “Update Driver.”

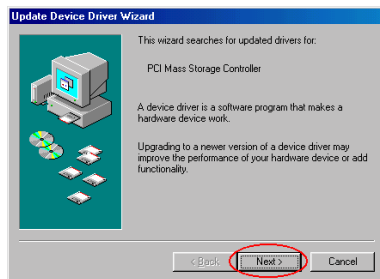

Step 4: Click “Next.”

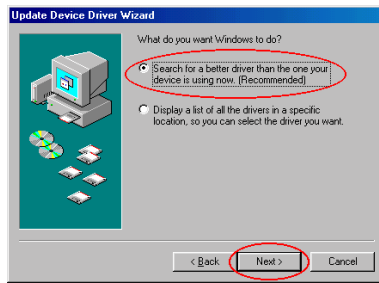

Step 5: Select “*Search for a better driver than the one your device is using now. (Recommended)*”, and then click “*Next.*”

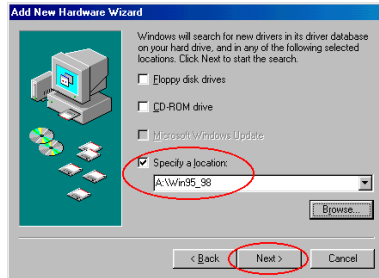

Step 6: Select “*Specify a Location*” and then type “*A:\Win95_98*” in the text box.

Click “*Next.*”

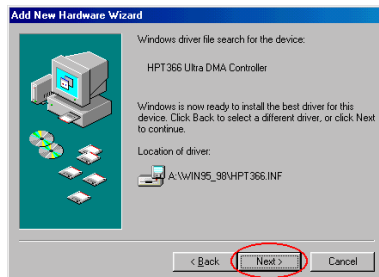

Step 7: Click “*Next.*”

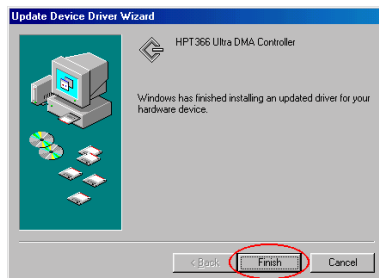

Step 8: Click “*Finish.*”

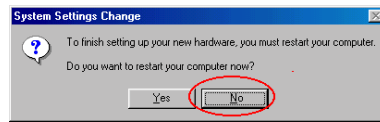

Step 9: Click “No” to continue updating another “*PCI Mass Storage Controller*” driver. The installation procedure is the same as Steps 3 to 10. After updating another controller driver, the system will ask you to restart your computer. Click “Yes” to restart your computer.

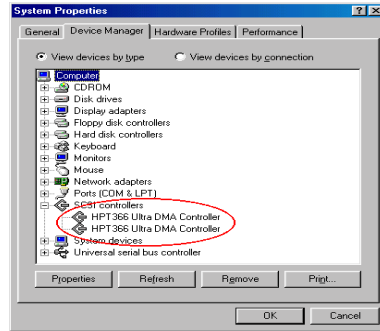

Step 10: After your system has restarted, you can enter “*Control Panel*” → “*System*”, and then select “*Device Manager*” → “*SCSI Controllers*”. If Ultra ATA/66 driver is installed correctly, you will see the figure on the left.

Windows NT 4.0

Installing drivers during Windows NT installation:

☺ CD-ROM disk Install:

The following instructions explain how to install the Ultra ATA/66 driver, while installing Windows NT 4.0.

Step 1: When you power the computer on, you will see the following message appear briefly at the bottom of the screen during POST:

PRESS DEL TO ENTER SETUP

Please press the **DEL** key immediately to enter the BIOS setup utility.

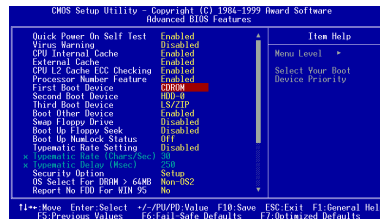

Step 2: Select “*BIOS FEATURE SETUP*” after you enter BIOS setup utility. Then set the “*Boot Sequence*” as “*CDROM,C,A*” (refer to figure left).

After you finished the setting, please remember to save it.

NOTE

If you have a **SCSI CDROM**, you have to set the "**Boot Sequence**" as "**EXT,C,A**" and the "**Boot Sequence EXT Means**" as "**SCSI**" in the "**BIOS Features Setup**"

Setup is inspecting your computer's hardware configuration...

Step 3: Insert the Windows NT installation CD (must be bootable) into your CD-ROM. Press the "**F6**" key immediately when the message "**Setup is inspecting your computer's hardware configuration...**" appears.

Windows NT Setup

Setup could not determine the type of on or more mass storage devices installed in your system, or you have chosen to manually specify an adapter. Currently setup will load support for the following mass storage devices):

....

QLogic PCI SCSI Adapter
 QMD PCI SCSI Controller/Ethernet Adapter
 BusLogic Flashpoint
 Compaq SCSI Fast-Wide SCSI-2/E

*To specify additional SCSI adapters, CD-ROM drives, or special disk controllers for use with Windows NT, including those for which you have a device support disk from a mass storage device manufacturer, press S.

*If you do not have any device support disks from a mass storage device manufacturer, or do not want to specify additional mass storage devices for use with Windows NT, press ENTER.

<Specify Additional Device> ENTER=Continue F3=Exit

Step 4: Press "**S**" to specify an additional device (Ultra ATA/66 IDE controller)

Windows NT Setup

Select the SCSI Adapter you want from the following list, or select "Other" if you have a device support disk provided by an adapter manufacturer.

QIwertt1 ESC-1/ESC-2 SCSI Host Adapter
 QLogic PCI SCSI Host Adapter
 MCI/sonosonic CD-ROM Controller
 Sony Proprietary CD-ROM Controller
 UltraStor 14F/14FB/34F/24F/54FB SCSI Host Adapter
 UltraStor 24F/24FB SCSI Host Adapter
 Others

ENTER=Select ESC=Cancel F3=Exit

Step 5: Press "**ENTER**" to select "**Others**"

Windows NT Setup

Please insert the disk labeled
 Manufacturer-supplied hardware support disk
 into Drive A
 • Press ENTER when ready

ENTER=Select ESC=Cancel F3=Exit

Step 6: Insert the Ultra ATA/66 Driver diskette into drive A, and press "**ENTER**".

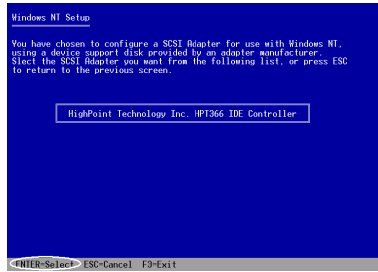

Step 7: Press “*ENTER*” to select “*HighPoint Technology Inc. HPT 366 IDE controller.*”

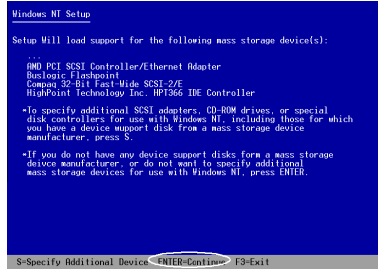

Step 8: Press “*ENTER*” to continue Windows NT 4.0 installation.

If you have followed the steps described above, you should be finished installing your Ultra ATA/66 IDE controller. For the rest of Windows NT installation steps, please follow the instructions displayed in the NT setup program.

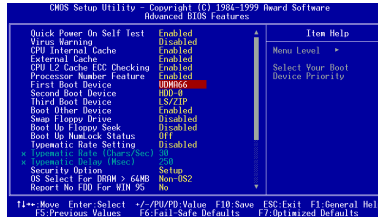

Step 9: After the first stage installation of Windows NT 4.0 is finished, you will need to restart your computer. Please enter the BIOS setup utility again when your system is rebooting (refer to step 1). Select “*BIOS FEATURE SETUP*” after you enter BIOS setup utility. Then set the “*Boot Sequence*”

as “*EXT,C,A*” and the “*Boot Sequence EXT Means*” as “*UDMA66.*”

NOTE

Don't remove your Windows NT installation CD after the first reboot because Windows NT setup is not finished yet and still needs to copy files from the CD-ROM.

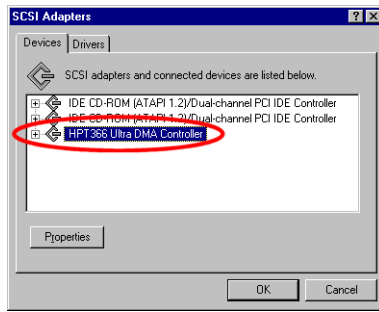

Step 10: After you have finished Windows NT installation and entered Windows NT, you can enter “*Control Panel*” → “*SCSI Adapters*”. If the Ultra ATA/66 IDE controller is installed correctly, you will see the figure on the left.

NOTE

- If you boot from a floppy and type “**WINNT /B**” to install the Windows NT 4.0, the installation steps are similar to the above steps. You only have to pay attention to two things. Firstly, don’t format your hard disk with the FAT32 file system. Otherwise, you will not be able to install Windows NT. Secondly, after the files have been copied to the hard disk, the system will reboot. On the reboot, press “**F6**” immediately when the message “*Setup is inspecting your computer’s hardware configuration...*” appears
- If you install a general drive to IDE1 (or IDE2) and an Ultra ATA/66 drive to IDE3 (or IDE4), we suggest you **don’t format your general drive with FAT32 file system**. Otherwise, you will encounter some problems when you install Windows NT on Ultra ATA/66 drive because the Windows NT have to write some data to the drive that connect to the primary IDE connector. But Windows NT can’t access the drive that format with FAT32 file system.

☺ Floppy Install:

If the NT 4.0 is first installed on the ATA/66 drive connected to IDE3 or IDE4, follow the following installation procedure:

Step 1: Set your system to boot from “*Drive A*” and then insert the Windows NT installation diskette 1/3. Power on your computer.

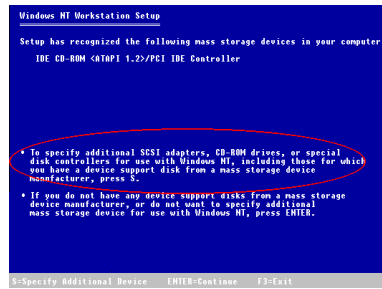

Step 2: The setup program will display a message about installing mass storage devices (see figure left) while you install NT4.0. Please press "S" to install Ultra ATA/66 driver.

NOTE

There are two suitable times to press "S" to install the Ultra ATA/66 driver. One is before the setup program autodetects your hardware. The other is after setup program autodetects your hardware. If you choose the former, you will need to install every device's driver manually. Therefore, we suggest you letting the setup program autodetects your hardware first, then press "S" to install the Ultra ATA/66 driver.

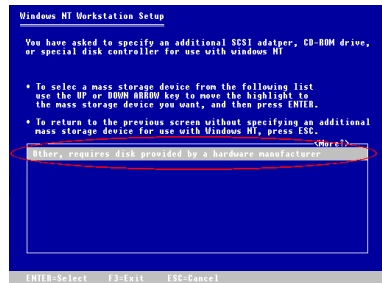

Step 3: Select "*Other, requires disk provided by a hardware manufacturer*", and then press "*ENTER*".

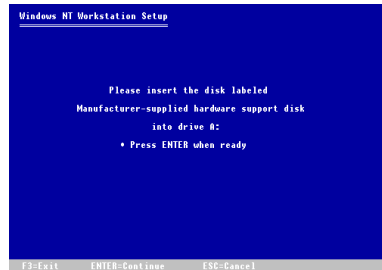

Step 4: Insert the Ultra ATA/66 driver disk into drive A, then press "*ENTER*".

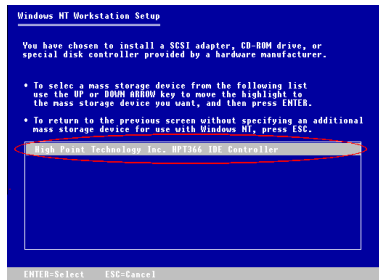

Step 5: Please press "**ENTER**" to continue setup.

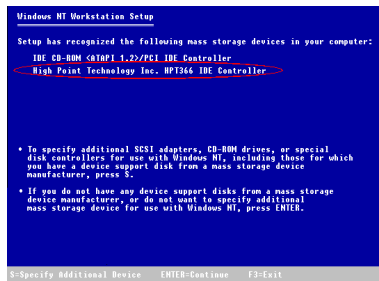

Step 6: The setup program will display a message (see left figure) to inform you NT setup has recognized the Ultra ATA/66 controller.

Press "**ENTER**" to continue setup.

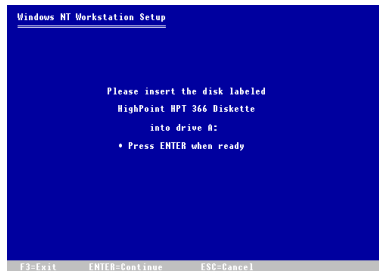

Step 7: After you configure your hard disk and specify the installation path, the NT setup will ask you to insert the Ultra ATA/66 driver disk into drive A again. Insert the driver disk, and then press "**ENTER**" to continue setup.

If you have followed the steps described above, you should be finished installing your Ultra ATA/66 controller. For the rest of Windows NT installation steps, please follow the instructions displayed in the NT setup program.

Installing drivers with existing Windows NT:

If there is an existing NT 4.0 file system, you can install the Ultra ATA/66 into the existing system by following procedure:

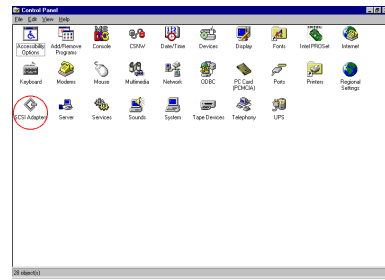

Step 1: Open "*Control Panel*", and then enter "*SCSI Adapters*".

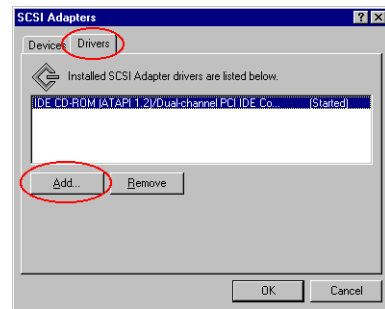

Step 2: Select "*Drivers*", and then click "*Add...*"

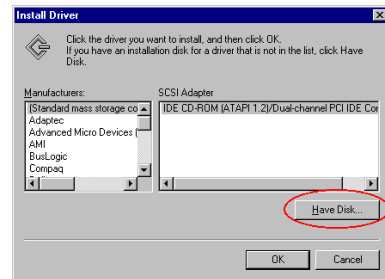

Step 3: Click "*Have Disk...*"



Step 4: Insert the Ultra ATA/66 driver disk into drive A, and then click "*OK.*"

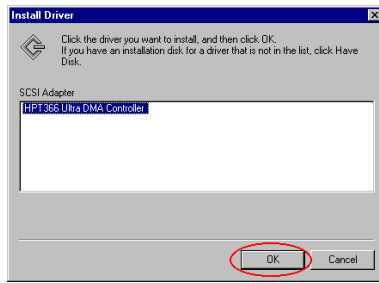

Step 5: Click "OK."

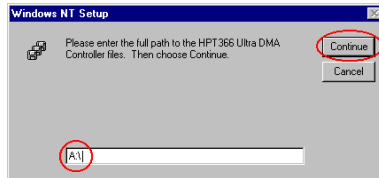

Step 6: Enter "A:\ " in blank space, and then click "Continue".

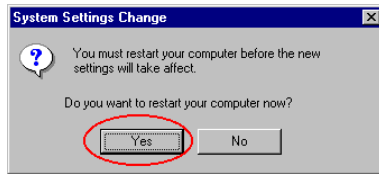

Step 7: Click "Yes" to restart your computer.

Appendix E The thermal cable

We provide a thermal cable in the motherboard package (see the figure below). This thermal cable is for you to detect the temperature in the location of your choice. You can attach one end of the two-threaded thermal cable (A) that comes with the motherboard to the TSYS2 header, then tape the other end of the thermal cable (B) onto the location you want to detect the temperature.

After you have installed the thermal cable, you will see the detected temperature in the BIOS Setup and Winbond Hardware Doctor Utility.

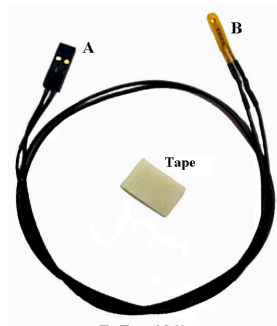

The Thermal Cable

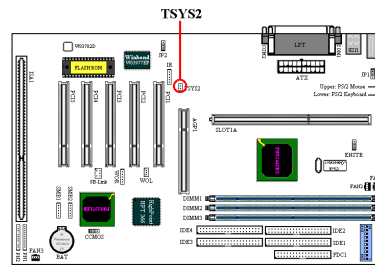

Appendix F Troubleshooting (Need Assistance?)

If you have a problem during operation and in order to help our technical support personnel to quickly find out what the problem of your motherboard is and to give you the answers you need, before filling in the technical support form, eliminate any peripheral that is not related to the problem, and indicate on the form, the key peripherals. Fax this form to your dealer or to the company where you bought the hardware in order to benefit from our technical support. (You can refer to the examples given below)



Example 1: With a system including: motherboard (with CPU, DRAM, COAST...) HDD, CD-ROM, FDD, VGA CARD, MPEG CARD, SCSI CARD, SOUND CARD, etc. After the system is assembled, if you cannot boot up, check the key components of the system using the procedure described below. First remove all interface cards except the VGA card and try to reboot.

☛ If you still cannot boot up:

Try installing another brand/model VGA card and see if the system will start. If it still does not start, note the VGA card model, motherboard model, Bios identification number, CPU on the technical support form (refer to main instructions), and describe the problem in the problem description space provided.

☛ If you can boot up:

Insert back the interface cards you have removed one by one and try to start the system each time you insert a card, until the system doesn't start anymore. Keep the VGA card and the interface card that causes the problem inserted on the motherboard, remove any other card or peripheral, and start again. If you still cannot start, note down the information related to both cards in the add-on Card space provided, and don't forget to indicate the motherboard model, version, BIOS identification number, CPU (refer to main instructions), and give a description of the problem.



Example 2: With a system including the motherboard (with CPU, DRAM, COAST...) HDD, CD-ROM, FDD, VGA CARD, LAN CARD, MPEG CARD, SCSI CARD, SOUND CARD, after assembly and after having installed the Sound Card Driver, when you restart the system, when it runs the Sound Card Driver, it resets automatically. This problem may be due to the Sound Card Driver.

During the Starting DOS... procedure, press SHIFT (BY-PASS) key, to skip CONFIG.SYS and AUTOEXEC.BAT; edit CONFIG.SYS with a text editor, and in function the line that loads the Sound Card Driver, add a remark REM, in order to disable the Sound Card Driver. See the example below.

```
CONFIG.SYS:
DEVICE=C:\DOS\HIMEM.SYS
DEVICE=C:\DOS\EMM386.EXE HIGHSCAN
DOS=HIGH, UMB
FILES=40
BUFFERS=36
REM DEVICEHIGH=C:\PLUGPLAY\DWCFGMG.SYS
LASTDRIVE=Z
```

Restart the system. If the system starts and does not reset, you can be sure that the problem is due to the Sound Card Driver. Note down the Sound Card model, motherboard model, BIOS identification number on the technical support file (refer to main instructions), and describe the problem in the space provided.

☺☺☺

Main instructions...

To fill in this "Technical Support Form", refer to the step-by-step instructions given below:

1* . MODEL: Note the model number given in your user's manual.

Example: BE6-II, BX6, BH6, etc...

2* . Motherboard model number (REV): Note the motherboard model number labeled on the motherboard as "REV:*.*".

Example: REV: 1.01

3* . BIOS ID and Part Number: See next page example.

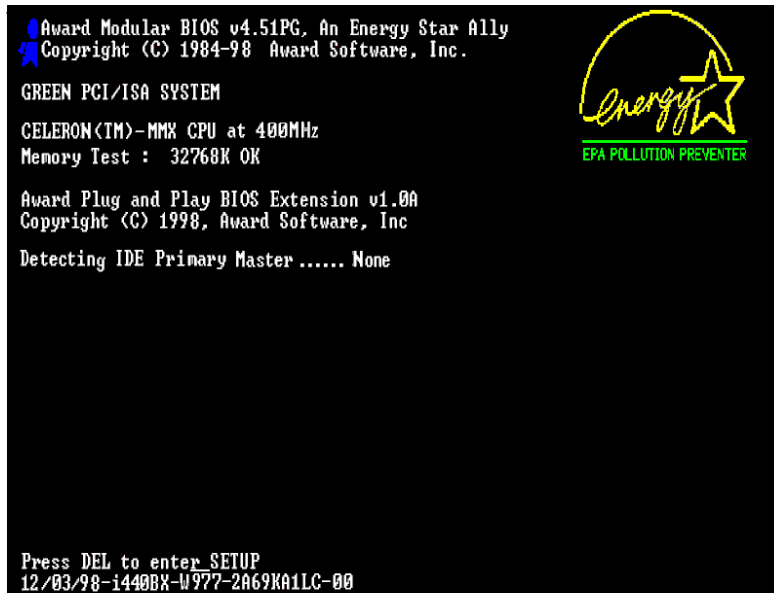

4. **DRIVER REV:** Note the driver version number indicated on the DEVICE DRIVER disk (if have) as "Release *.*". For example:

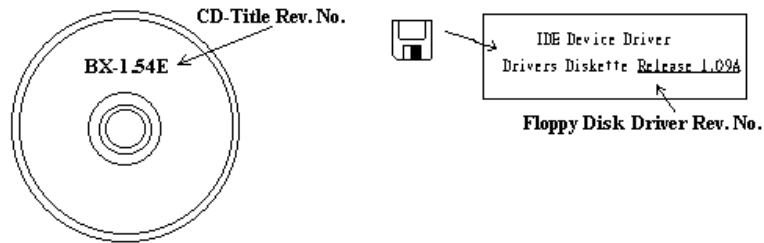

- 5*. OS/APPLICATION:** Indicate what are the operating system and the applications your are running on the system.

Example: MS-DOS® 6.22, Windows® 95, Windows® NT....

- 6*. CPU:** Indicate the brand and the speed (MHz) of your CPU.

Example:(A) In the “Brand” space, write “Intel”, in the “Specifications” space, write “Pentium® II MMX 300MHz”.

- 7. HDD:** Indicate the brand and specifications of your HDD(s), specify if the HDD is using IDE1 or IDE2. If you know the disk capacity, indicate it and check (“✓”) “”; in case you give no indication, we will consider that your HDD is “IDE1” Master.

Example: In the “HDD” space, check the box, in the Brand space, write “Seagate”, in the Specifications space, write “ST31621A (1.6GB)”.

- 8. CD-ROM Drive:** Indicate the brand and specifications of your CD-ROM drive. Specify if it uses IDE1 or IDE2 and check (“✓”) “”; in case you give no indication, we will consider that your CD-ROM is “IDE2” Master.

Example: In the “CD-ROM drive” space, check the box, in the Brand space, write “Mitsumi”, in the Specifications space, write “FX-400D”.

- 9. System Memory (DRAM):** Indicate the brand and specifications (SIMM / DIMM) of your system memory. For example:

In the Brand space, write “Panasonic”, in the Specifications space, write “SIMM-FP DRAM 4MB-06”.

Or, in the Brand, write “NPNX”, in the Specifications space, write “SIMM-EDO DRAM 8MB-06”.

Or, in the Brand space, write “SEC”, in the Specifications space, write “DIMM-S DRAM 8MB-G12”.

- 10. ADD-ON CARD:** Indicate which add-on cards you are *absolutely sure* are related to the problem.

If you cannot identify the problem’s origin, indicate all the add-on cards inserted into your system.

Note

Items between the “*” are absolutely necessary.

Technical Support Form

Company name:

 Phone #:

 Contact:

 Fax #:

Model	*	BIOS ID #	*
Motherboard Model No.		DRIVER REV	
OS/Application	*		
Hardware name	Brand	Specifications	
CPU	*		
HDD			
	<input type="checkbox"/> IDE1		
	<input type="checkbox"/> IDE2		
CD-ROM Drive			
	<input type="checkbox"/> IDE1		
	<input type="checkbox"/> IDE2		
System Memory (DRAM)			
ADD-ON CARD			



Problem Description:



