



MS-6119 ATX BX2 Mainboard Specification & User's Guide

1. Introduction

The MSI ATX BX2 mainboard is a high-performance personal computer mainboard based on the Pentium® II processor. The Pentium® II processor supports MMX™ (Multimedia Extension) technology.

The mainboard uses the highly integrated Intel® 82443BX AGP chipset to support the PCI/ISA and Green standards, and to provide the Host/AGP bridge. The Intel® 82371AB chipset integrates all system control functions such as ACPI (Advanced Configuration and Power Interface). The ACPI provides more Energy Saving Features for the OSPM (OS Direct Power Management) function. The Intel® 82371EB chipset also improves the IDE transfer rate by supporting Ultra DMA/33 IDE that transfers data at the rate of 33MB/s.

The mainboard also supports the LM78 System Hardware Monitor Controller as an optional function. The LM78 function includes: CPU /power supply/chassis fan revolution detect, CPU/system voltage monitor, system temperature monitor, and chassis intrusion detect(optional).



Table of Contents

1. Introduction.....1

2. Mainboard Specification.....3

3. Mainboard Layout.....6

4. Backpanel Layout.....7

 4.1 Connectors.....7

 4.1-1 Mouse Connector.....7

 4.1-2 Keyboard Connector.....8

 4.1-3 USB Connectors.....8

 4.1-4 Parallel Port Connector.....9

 4.1-5 Serial Port Connectors.....10

5. Slot 1.....11

6. DIMM DRAM Addressing.....15

7. CPU Fan Power Connector.....16

8. Irda Infrared Module Connector..... 16

Appendixes

2. Mainboard Specification

FEATURES	SPECIFICATIONS
CPU	<ul style="list-style-type: none"> • Slot 1 for Pentium® II Processor . • Supports 200MHz, 233MHz, 266MHz, 300MHz, 333MHz, and faster. • Core/Bus ratios are x2, x2.5, x3, x3.5, x4, x4.5, x5, x5.5, x6 and higher.
Switching Voltage Regulator	<ul style="list-style-type: none"> • On-board switching mode DC-DC Step Down Regulator. • Conforms to Intel® VRM ver 8.2 specifications. • Over-Voltage and Over-Current protection.
Chipset	<ul style="list-style-type: none"> • Intel® 82443BX AGP chipset.
Clock Generator	<ul style="list-style-type: none"> • 66.6MHz and 100MHz clocks are supported. (75 MHz and 83MHz reserved)
Main Memory	<ul style="list-style-type: none"> • Supports eight memory banks using three 168-pin unbuffered DIMM sockets. • Supports a maximum memory size of 384MB (8M x 8) or 768MB(16M x 4) registered DIMM only. • Supports ECC(1-bit Error Code Correct) and EC(Multiple-Bit Error Checking) function. • Supports 3.3v SDRAM DIMM.
Slots	<ul style="list-style-type: none"> • One AGP(Accelerated Graphics Port) slot. <ul style="list-style-type: none"> - AGP specification compliant - AGP 66/133MHz 3.3v device support • Four 32-bit Master PCI Bus slots and three 16-bit ISA bus slots wherein one shared slot can be used as ISA or PCI. • Supports 3.3v/5v PCI bus Interface.
On-Board IDE	<ul style="list-style-type: none"> • An IDE controller on the Intel® 82371EB PCI Chipset provides IDE HDD/CD-ROM with PIO, Bus Master and Ultra DMA/33 operation modes. • Can connect up to four IDE devices.



FEATURES	SPECIFICATIONS
On-Board Peripherals	<ul style="list-style-type: none"> ● On-Board Peripherals include: <ul style="list-style-type: none"> - 1 floppy port supports 2 FDD with 360K, 720K, 1.2M, 1.44M and 2.88Mbytes. - 2 serial ports (COMA + COMB) - 1 parallel port supports SPP/EPP/ECP mode - 2 USB ports - 1 IrDA connector for Fast IrDA(reserved).
BIOS	<ul style="list-style-type: none"> ● The mainboard BIOS provides “Plug & Play” BIOS which detects the peripheral devices and expansion cards of the board automatically. ● The mainboard provides a Desktop Management Interface(DMI) function which records your mainboard specifications.
On-Board System Hardware Monitor(LM78)	<ul style="list-style-type: none"> ● CPU/Power Supply/Chassis Fan Revolution Detect ● CPU Fan Control (the fan will automatically stop when the system enters suspend mode) ● System Voltage Detect ● CPU Overheat Warning (reserved) ● Chassis Intrusion Detect(reserved) ● Display Actual Current Voltage
RTC	<ul style="list-style-type: none"> ● PIIX4(82371EB) built-in RTC.
Keyboard Connector	<ul style="list-style-type: none"> ● PS/2[®] keyboard interface and PS/2[®] mouse interface.
Dimension	<ul style="list-style-type: none"> ● ATX Form Factor: 30cm(L) x 18.6cm(W) x 4 layers PCB. ● Double deck PS/2[®] keyboard & PS/2[®] mouse. ● Double deck USB port. ● Double deck Serial & LPT port. ● Double deck I/O connectors, compatible with Intel[®] Venus Mainboard.
Mounting	<ul style="list-style-type: none"> ● 6 mounting holes.



FEATURES	SPECIFICATIONS
Other features	<ul style="list-style-type: none">• Keyboard Password Wake-Up• LAN Wake-Up• Internal/External Modem Wake-Up



3. Mainboard Layout

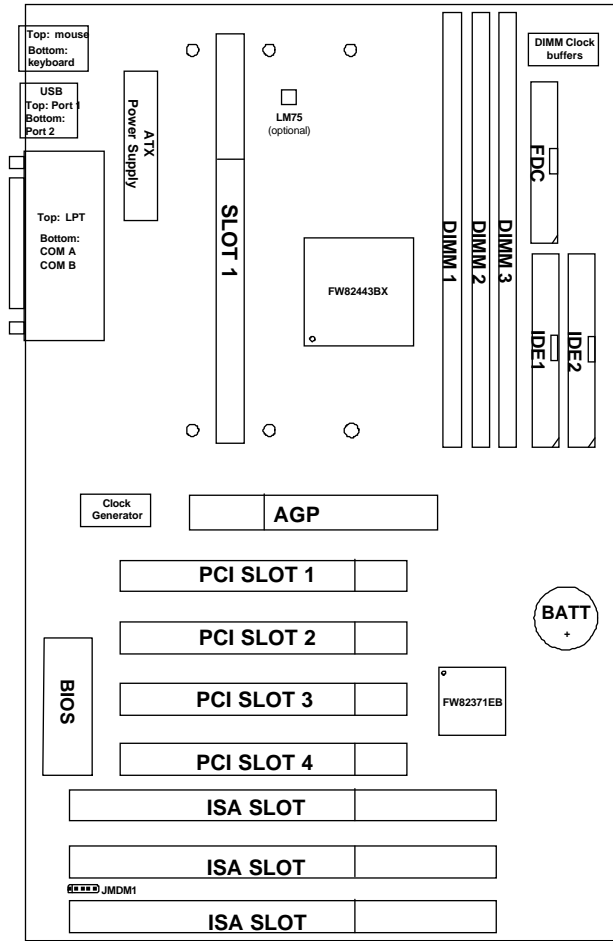

4. Backpanel Layout

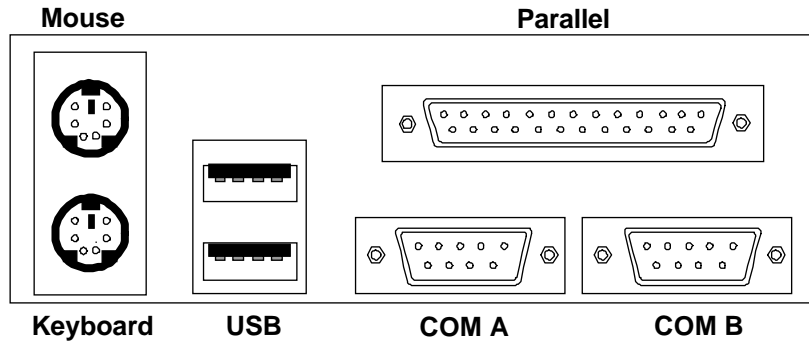

4.1 Connectors

4.1-1 Mouse Connector

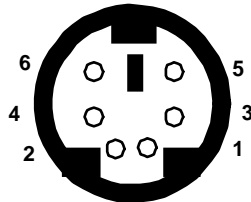

PS/2 Mouse (6-pin Female)

PIN	SIGNAL	DESCRIPTION
1	Mouse DATA	Mouse DATA
2	NC	No connection
3	GND	Ground
4	VCC	+5V
5	Mouse Clock	Mouse clock
6	NC	No connection

PS/2 Mouse Pin Definition

4.1-2 Keyboard Connector

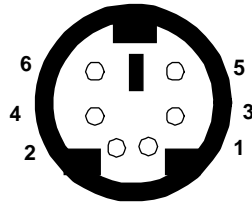

PS/2 Keyboard (6-pin Female)

PIN	SIGNAL	DESCRIPTION
1	Keyboard DATA	Keyboard DATA
2	NC	No connection
3	GND	Ground
4	VCC	+5V
5	Keyboard Clock	Keyboard clock
6	NC	No connection

PS/2 Keyboard Pin Definition

4.1-3 USB Connectors

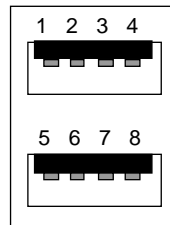

USB Ports

PIN	SIGNAL	DESCRIPTION
1	VCC	+5V
2	-Data 0	Negative Data Channel 0
3	GND	Ground
4	+Data 0	Positive Data Channel 0
5	VCC	+5V
6	+Data 1	Positive Data Channel 1
7	-Data 1	Negative Data Channel 1
8	GND	Ground

USB Port Description



4.1-4 Parallel Port Connector

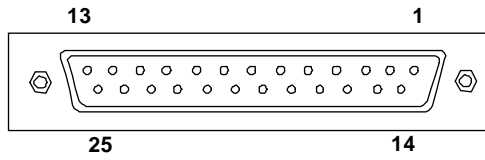

LPT 25-Pin Male Connectors

PIN	SIGNAL	DESCRIPTION
1	STROBE	Strobe
2	DATA0	Data0
3	DATA1	Data1
4	DATA2	Data2
5	DATA3	Data3
6	DATA4	Data4
7	DATA5	Data5
8	DATA6	Data6
9	DATA7	Data7
10	ACK#	Acknowledge
11	BUSY	Busy
12	PE	Paper End
13	SELECT	Select
14	AUTO FEED#	Automatic Feed
15	ERR#	Error
16	INIT#	Initialize Printer
17	SLIN#	Select In
18	GND	Ground
19	GND	Ground
20	GND	Ground
21	GND	Ground
22	GND	Ground
23	GND	Ground
24	GND	Ground
25	GND	Ground1



4.1-5 Serial Port Connectors

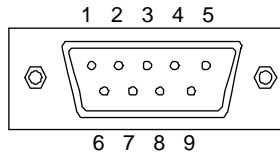

COM A / COMB 9-Pin male DIN connectors

PIN	SIGNAL	DESCRIPTION
1	DCD	Data Carry Detect
2	SIN	Serial In or Receive Data
3	SOUT	Serial Out or Transmit Data
4	DTR	Data Terminal Ready)
5	GND	Ground
6	DSR	Data Set Ready
7	RTS	Request To Send
8	CTS	Clear To Send
9	RI	Ring Indicate



5. Slot 1

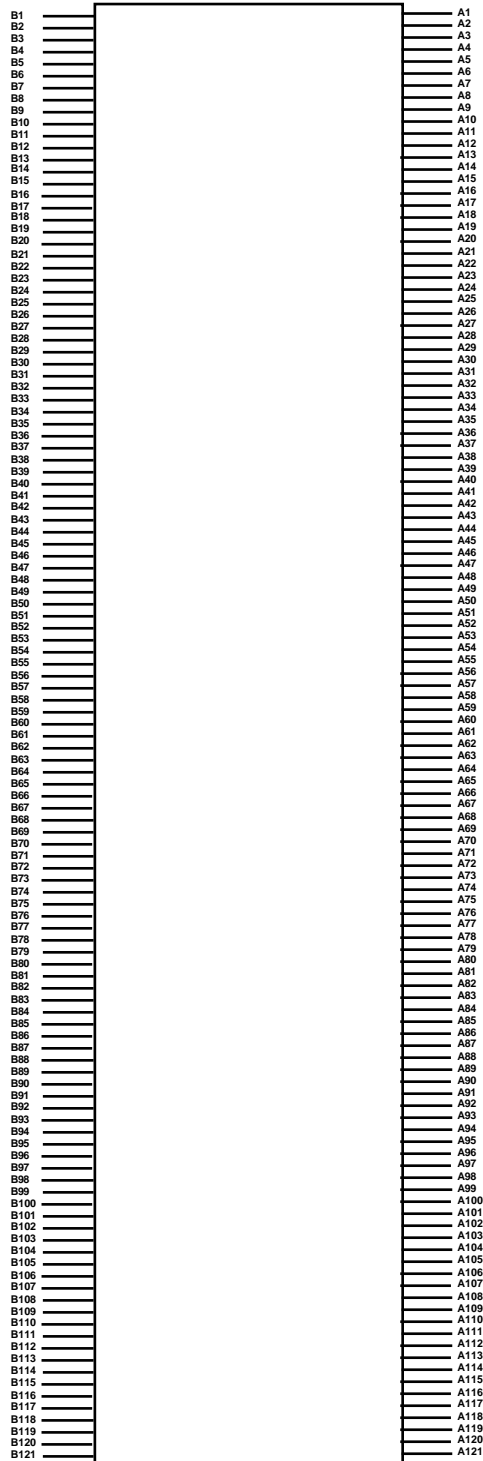



Slot 1 Pin Definition

PIN	SIGNAL	PIN	SIGNAL
A1	VCC_VTT	A46	GND
A2	GND	A47	RESERVED
A3	VCC_VTT	A48	D#[43]
A4	IERR#	A49	D#[37]
A5	A20M#	A50	GND
A6	GND	A51	D#[33]
A7	FERR#	A52	D#[36]
A8	IGNNE#	A53	D#[31]
A9	TDI	A54	GND
A10	GND	A55	D#[30]
A11	TDO	A56	D#[27]
A12	PWRGOOD	A57	D#[24]
A13	TESTHI1	A58	GND
A14	GND	A59	D#[23]
A15	THERMTRIP#	A60	D#[21]
A16	RESERVED	A61	D#[16]
A17	LINT[0]/INTR	A62	GND
A18	GND	A63	D#[13]
A19	PICD[0]	A64	D#[11]
A20	PREQ#	A65	D#[10]
A21	BP#[3]	A66	GND
A22	GND	A67	D#[14]
A23	BPM#[0]	A68	D#[9]
A24	BINIT#	A69	D#[8]
A25	DEP#[0]	A70	GND
A26	GND	A71	D#[5]
A27	DEP#[1]	A72	D#[3]
A28	DEP#[3]	A73	D#[1]
A29	DEP#[5]	A74	GND
A30	GND	A75	BCLK
A31	DEP#[6]	A76	BREQ0#
A32	D#[61]	A77	BERR#
A33	D#[55]	A78	GND
A34	GND	A79	A#[33]
A35	D#[60]	A80	A#[34]
A36	D#[53]	A81	A#[30]
A37	D#[57]	A82	GND
A38	GND	A83	A#[31]
A39	D#[46]	A84	A#[27]
A40	D#[49]	A85	A#[22]
A41	D#[51]	A86	GND
A42	GND	A87	A#[23]
A43	D#[42]	A88	RESERVED
A44	D#[45]	A89	A#[19]
A45	D#[39]	A90	GND



PIN	SIGNAL	PIN	SIGNAL
A91	A#[18]	B1	EMI
A92	A#[16]	B2	FLUSH#
A93	A#[13]	B3	SMI#
A94	GND	B4	INIT#
A95	A#[14]	B5	VCC_VTT
A96	A#[10]	B6	STPCLK#
A97	A#[5]	B7	TCK
A98	GND	B8	SLP#
A99	A#[9]	B9	VCC_VTT
A100	A#[4]	B10	TMS
A101	BNR#	B11	TRST#
A102	GND	B12	RESERVED
A103	BPRI#	B13	VCC_CORE
A104	TRDY#	B14	THRMDA(+)
A105	DEFER#	B15	THRMDC(-)
A106	GND	B16	LINT[1]/NMI
A107	REQ#[2]	B17	VCC_CORE
A108	REQ#[3]	B18	PICCLK
A109	HITM#	B19	BP#[2]
A110	GND	B20	RESERVED
A111	DBSY#	B21	100/66#
A112	RS#[1]	B22	PICD[1]
A113	RESERVED	B23	PRDY#
A114	GND	B24	BPM#[1]
A115	ADS#	B25	VCC_CORE
A116	RESERVED	B26	DEP#[2]
A117	AP#[0]	B27	DEP#[4]
A118	GND	B28	DEP#[7]
A119	VID[2]	B29	VCC_CORE
A120	VID[1]	B30	D#[62}
A121	VID[4]	B31	D#[58]
		B32	D#[63]
		B33	VCC_CORE
		B34	D#[56]
		B35	D#[50]
		B36	D#[54}
		B37	VCC_CORE
		B38	D#[59]
		B39	D#[48]
		B40	D#[52]
		B41	EMI
		B42	D#[41]
		B43	D#[47]
		B44	D#[44]
		B45	VCC_CORE



PIN	SIGNAL	PIN	SIGNAL
B46	D#[36]	B91	A#[17]
B47	D#[40]	B92	A#[11]
B48	D#[34]	B93	VCC_CORE
B49	VCC_CORE	B94	A#[12]
B50	D#[38]	B95	A#[8]
B51	D#[32]	B96	A#[7]
B52	D#[28]	B97	VCC_CORE
B53	VCC_CORE	B98	A#[3]
B54	D#[29]	B99	A#[6]
B55	D#[26]	B100	EMI
B56	D#[25]	B101	SLOT0CC#
B57	VCC_CORE	B102	REQ#[0]
B58	D#[22]	B103	REQ#[1]
B59	D#[19]	B104	REQ#[4]
B60	D#[18]	B105	VCC_CORE
B61	EMI	B106	LOCK
B62	D#[20]	B107	DRDY#
B63	D#[17]	B108	RS#[0]
B64	D#[15]	B109	VCC_5
B65	VCC_CORE	B110	HIT#
B66	D#[12]	B111	RS#[2]
B67	D#[7]	B112	RESERVED
B68	D#[6]	B113	VCC_3
B69	VCC_CORE	B114	RP#
B70	D#[4]	B115	RSP#
B71	D#[2]	B116	AP#[1]
B72	D#[0]	B117	VCC_3
B73	VCC_CORE	B118	AERR#
B74	RESET#	B119	VID[3]
B75	BREQ1#	B120	VID[0]
B76	FRCERR#	V121	VCC_3
B77	VCC_CORE		
B78	A#[35]		
B79	A#[32]		
B80	A#[29]		
B81	EMI		
B82	A#[26]		
B83	A#[24]		
B84	A#[28]		
B85	VCC_CORE		
B86	A#[20]		
B87	A#[21]		
B88	A#[25]		
B89	VCC_CORE		
B90	A#[15]		



6. DIMM DRAM Addressing

DRAM Tech.	DRAM Density & Width	DRAM Addressing	Address Size		MB/DIMM	
			Row	Column	Single no. Side(S) pcs.	Double no. Side(D) pcs.
16M	1Mx16	ASYM	11	8	8MBx4	16MBx8
	2Mx8	ASYM	11	9	16MBx8	32MBx16
	4Mx4	ASYM	11	10	32MB	64MB
64M	2Mx32	ASYM	11	8		
	4Mx16	ASYM	12	8		
	8Mx8	ASYM	12	9		
	16Mx4	ASYM	12	10		

440BX SDRAM Addressing



7. CPU Fan Power Connector

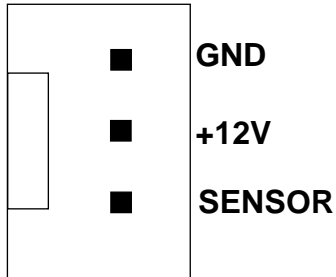

8. IrDA Infrared Module Connector

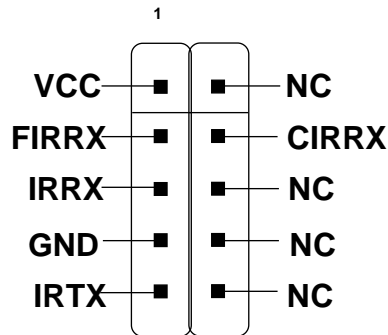



Appendix A

CPU Core Speed Derivation Procedure

1. The DIP Switch SW1 (4 & 5) is used to adjust the CPU clock frequency.

SW1		CPU
5	6	Clock
OFF	ON	66.6MHz
ON	ON	100MHz

Note: It is best to set the clock at 100MHz.
For it will adjust itself to 66MHz if needed.

2. The DIP Switch SW1 (1, 2, 3, and 4) is used to set the Core/Bus (Fraction) ratio of the CPU. The actual core speed of the CPU is the Host Clock Frequency multiplied by the Core/Bus ratio. For example:

$$\begin{aligned}
 \text{If } & \text{CPU Clock} & = & 66\text{MHz} \\
 & \text{Core/Bus ratio} & = & 1.5 \\
 \text{then } & \text{CPU core speed} & = & \text{Host Clock} \times \text{Core/Bus ratio} \\
 & & = & 66\text{MHz} \times 1.5 \\
 & & = & 100\text{MHz}
 \end{aligned}$$

SW1				CPU
1	2	3	4	Core/Bus Ratio
ON	OFF	ON	ON	2.5
ON	ON	OFF	ON	3
ON	OFF	OFF	ON	3.5
ON	ON	ON	OFF	4
ON	OFF	ON	OFF	4.5
ON	ON	OFF	OFF	5
ON	OFF	OFF	OFF	5.5
OFF	ON	ON	ON	6
OFF	OFF	ON	ON	6.5
OFF	ON	OFF	ON	7
OFF	OFF	OFF	ON	7.5
OFF	ON	ON	OFF	8

3. The PCI Bus Clock is fixed at 33MHz.



Jumpers

Flash ROM Programming Voltage: JMODE1

This jumper is for setting the voltage of the Flash ROM BIOS.

JMODE1

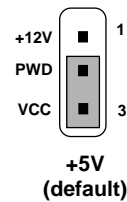
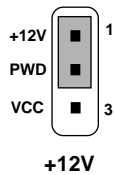

- Note:**
- a. Short 1-2 pin, if you're using Intel® or MXIC flash memory and you want to flash the ROM data.
 - b. Short 2-3 pin, if you're using Intel® or MXIC flash memory for normal operation.
 - c. Leave JMODE1 open, if you're using Winbond flash memory.

External Battery Connector: JBAT1

A battery must be used to retain the mainboard configuration in CMOS RAM. If you use the on-board battery, you must short 1-2 pins of JBAT1 to keep the CMOS data.

JBAT1

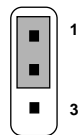

Keep Data

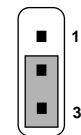



Clear Data

- Note:** You can clear CMOS by shorting 2-3 pin, while the system is off. Then, return to 1-2 pin position. Avoid clearing the CMOS while the system is on; it will damage the mainboard.



Power On Mode Jumper: JP2

The mainboard supports two kinds of system boot up: the Boot-Up by switch and the Immediate Boot-Up. With the Boot-Up by Switch, the system will boot up only when the power on switch is pressed. For Immediate Boot-Up, the system will boot up instantly when the power connector is connected into the system.

JP2	Feature
	Select Boot-Up by Switch
	Select Immediate Boot-Up

Note: Short **JP2**, when using Boot-Up by Switch feature. Open **JP2**, to enable Immediate Boot-Up.



Connectors

Floppy Disk Connector: FDC

The mainboard also provides a standard floppy disk connector FDC that supports 360K, 720K, 1.2M, 1.44M and 2.88M floppy disk types. This connector supports the provided floppy drive ribbon cable.

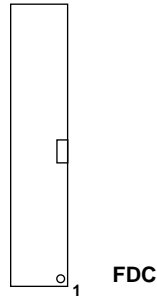

Hard Disk Connectors: IDE1 & IDE2

The mainboard has a 32-bit Enhanced PCI IDE Controller that provides PIO mode 0~4, Bus Master, and Ultra DMA/33 function. It has two HDD connectors IDE1 (primary) and IDE2 (secondary). You can connect up to four hard disk drives, CD-ROM, 120MB Floppy (reserved for future BIOS) and other devices to IDE1 and IDE2. These connectors support the provided IDE hard disk cable.

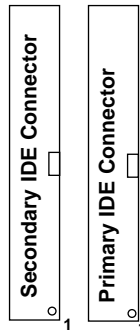

IDE1(Primary IDE Connector)

The first hard drive should always be connected to IDE1. IDE1 can connect a Master and a Slave drive. You must configure second hard drive to Slave mode by setting the jumper accordingly.

IDE2(Secondary IDE Connector)

IDE2 can also connect a Master and a Slave drive.



Case Connector: JFP1

The Turbo LED, Reset Switch, Keylock, Power LED, Speaker and HDD LED are all connected to the JFP connector block.

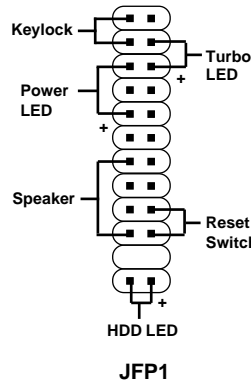

Turbo LED

The Turbo LED is always ON. You can connect the Turbo LED from the system case to this pin.

Reset Switch

Reset switch is used to reboot the system rather than turning the power ON/OFF. Avoid rebooting while the HDD LED is lit. You can connect the Reset switch from the system case to this pin.

Keylock

Keylock allows you to disable the keyboard for security purposes. You can connect the keylock to this pin.

Power LED

The Power LED is always lit while the system power is on. You can connect the Power LED from the system case to this pin.

Speaker

Speaker from the system case is connected to this pin.

HDD LED

HDD LED shows the activity of a hard disk drive. Avoid tuning the power off while the HDD led is lit. You can connect the HDD LED from the system case to this pin.

ATX 20-pin Power Connector: JWR1

This connector supports the power button on-board. Using the ATX power supply, functions such as Modem Ring Wake-Up and Soft Power Off are supported by this mainboard.

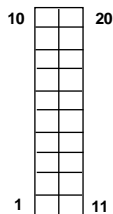

ATX Power Connector

PIN	SIGNAL	PIN	SIGNAL
1	3.3V	11	3.3V
2	3.3V	12	-12V
3	GND	13	GND
4	5V	14	PS_ON
5	GND	15	GND
6	5V	16	GND
7	GND	17	GND
8	PW_OK	18	-5V
9	5V_SB	19	5V
10	12V	20	5V



Remote Power On/Off Switch: JRMS1/JRMS2

Connect to a 2-pin push button switch. Every time the switch is shorted by pushing it once, the power supply will change its status from OFF to ON. **During ON stage, push once and the system goes to sleep mode: pushing it more than 4 seconds will change its status from ON to OFF.** If you want to change the setup, you could go to the BIOS Power Management Setup. This is used for ATX type power supply.



JRMS1 / JRMS2

Note: The two switches are provided by the mainboard for your convenience, so you can use any of them. The two switches have the same feature.

Chassis Intrusion Connector: JP3

This connector is connected to 2-pin connector chassis switch. If the Chassis is open, the switch will be short. The system will record this status. To clear the warning, you must enter the BIOS setting and clear the status.



JP3



Modem Wake Up Connector: JMDM1

The JMDM1 connector is for used with Modem add-on card that supports the Modem Wake Up function.

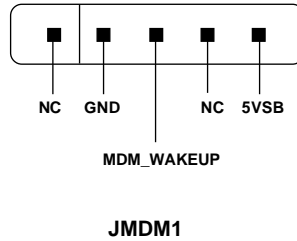

Note: Modem wake-up signal is active “low”.

Wake-Up on LAN connector: JWOL1

The JWOL1 connector is for use with LAN add-on cards that supports Wake Up on LAN function.

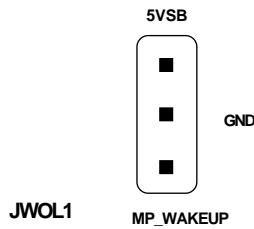

Note: LAN wake-up signal is active “high”.

Add-On Card Sound Connector: J3

The mainboard provides a distributed DMA connector for PCI sound card with this feature, such as Creative® PCI 3D sound card.

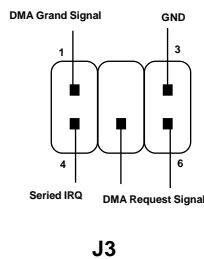

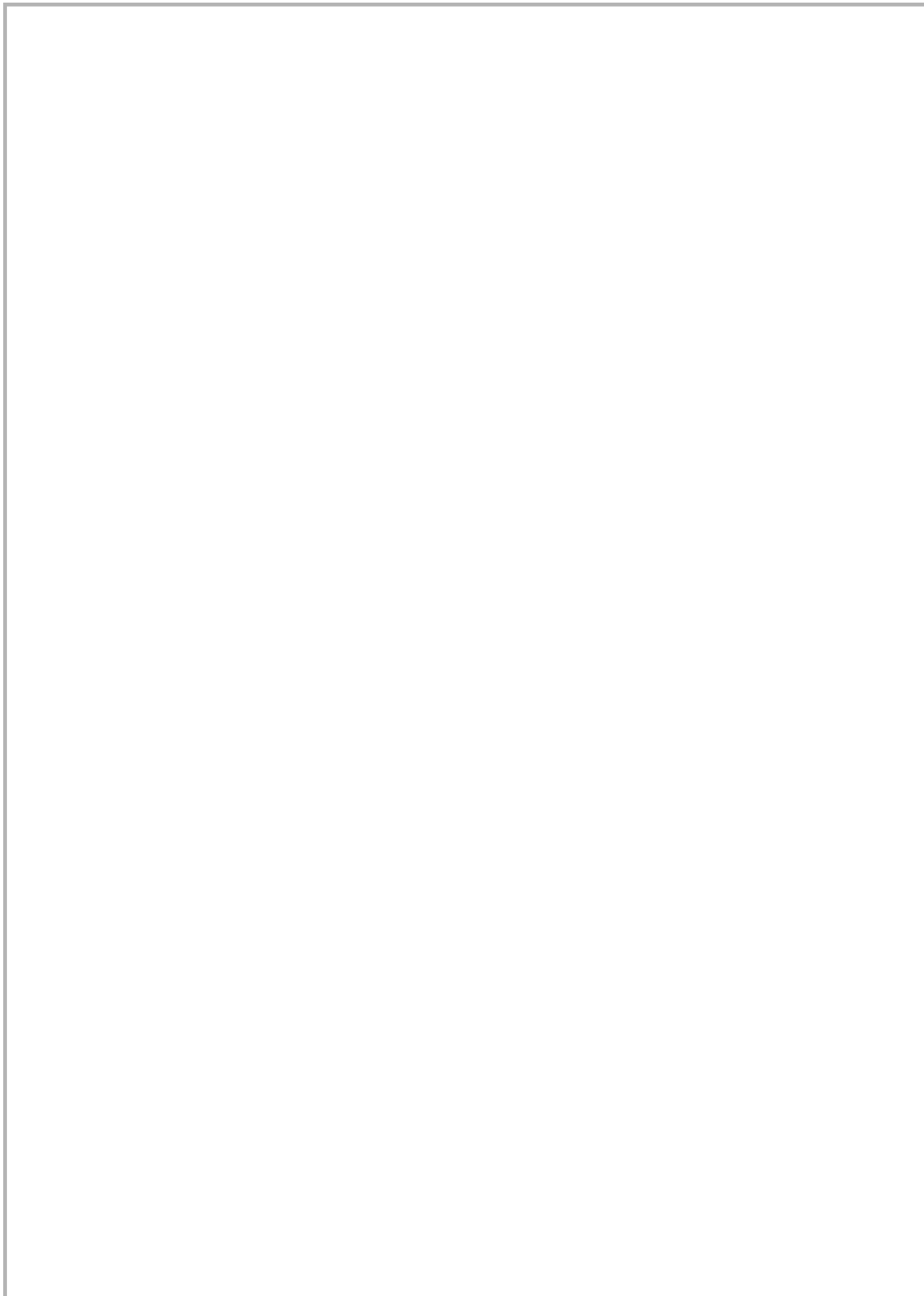



Appendix B - Schematics



Notes



Appendix C - Bill for Materials



Notes



Appendix D - Mechanical Drawings



Notes



Appendix E - Test Reports

MAIN OFFICE

MICRO-STAR INTERNATIONAL

No. 69, Li-De St., Jung-He City,
Taipei Hsien, Taiwan
Tel: 886-2-3234-5599
Fax: 886-2-3234-5488
[http:// www.msi.com.tw](http://www.msi.com.tw)

BRANCH OFFICES

ACHME COMPUTER INC. (USA)

4059 Clipper Court, Fremont
CA 94538, U.S.A.
Tel: 1-510-623-8818
Fax: 1-510-623-8585
BBS: 1-510-623-7398
[http:// www.achme.com](http://www.achme.com)

MSI COMPUTER GMBH (GERMANY)

Waldstrasse 23
63128 Dietzenbach 2, Germany
Tel: 49-6074-42057
Fax: 49-6074-29143
BBS: 49-6074-35554
Email: msi@ipf.de

MSI COMPUTER SARL (FRANCE)

19 Boulevard Georges Bidault
77183 Croissy-Beaubourg, France
Tel: 33-1-60370011
Fax: 33-1-60370066
[http:// www.msi-computer.fr](http://www.msi-computer.fr)
Email: msi-info@msi-computer.fr

MSI JAPAN (JAPAN)

3F, Hiura Bldg., 4-8-8, Sotokanda
Chiyoda-Ku, Tokyo 101, Japan
Tel: 81-3-3251-0494
Fax: 81-3-3251-0601

MSI SHANGHAI (CHINA)

10F, No. 400, Zhe Jiang Rd.
Shanghai, P.R.C.
Tel: 86-21-63518210
Fax: 86-21-63518211

The material in this document is the intellectual property of **MICRO-STAR INTERNATIONAL**. We take every care in the preparation of this document, but no guarantee is given as to the correctness of its contents. Our products are under continual improvement and we reserve the right to make changes without notice.

