

PT-5ITB
SYSTEM BOARD
(VER. 1.x)

OPERATION MANUAL

TABLE OF CONTENTS

Chapter & Section	Page
1. INTRODUCTION	1-1
1.1 SYSTEM OVERVIEW	1-1
2. SPECIFICATIONS	2-1
3. SYSTEM BOARD LAYOUT	3-1
3.1 PT-5ITB VER. 1.x	3-1
4. HARDWARE SETUP	4-1
4.1 UNPACKING	4-1
4.2 HARDWARE CONFIGURATION	4-1
4.2.1 CONNECTORS	4-2
4.2.2 JUMPERS	4-9
4.3 INSTALLING A CPU IN THE ZIF SOCKET	4-17
4.4 INSTALLATION OF CPU COOLING FAN	4-19
4.5 UPGRADING SYSTEM MEMORY	4-20
4.5.1 Installing a SIMM module	4-20
4.5.2 Installing a DIMM Module	4-21
4.5.3 Memory Module Installing	4-22
5. AWARD BIOS SETUP	5-1
5.1 GETTING STARTED	5-1
5.2 MAIN MENU	5-2
5.3 CONTROL KEYS	5-2
5.4 STANDARD CMOS SETUP	5-3
5.5 BIOS FEATURES SETUP	5-5
5.6 CHIPSET FEATURES SETUP	5-6
5.7 POWER MANAGEMENT SETUP	5-8
5.8 PNP/PCI CONFIGURATION	5-9
5.9 INTEGRATED PERIPHERALS	5-11
5.10 LOAD SETUP DEFAULTS	5-12
5.11 SUPERVISOR PASSWORD / USER PASSWORD	5-12
5.12 IDE HDD AUTO DETECTION	5-12
5.13 HDD LOW LEVEL FORMAT	5-12
5.14 SAVE &EXIT SETUP	5-12
5.15 EXIT WITHOUT SAVING	5-13

TRADEMARDKS

All trademarks used in this manual are the property of their respective owners.

NOTE

The “LOAD SETUP DEFAULTS” function loads the default settings directly from BIOS default table, these default settings are the best-case values that will optimize system performance and increase system stability. This function will be necessary when you receive this system board, or the system CMOS data is corrupted.

By pressing “Enter” key. The SETUP default values will be loaded. (Please refers to the Chapter 5 AWARD BIOS SETUP procedures in this manual.)

NOTICE

Information presented in this manual has been carefully checked for reliability; however, no responsibility is assumed for inaccuracies. The information contained in this manual is subject to change without notice.

1. INTRODUCTION

1.1 SYSTEM OVERVIEW

The □PT-5ITB□Pentium PCI Local Bus system mainboard is designed based on AT form-factor on the Intel 82430TX PCIset system chipsets and Winbond I/O chipset, which built-in two channels PIO and Bus Master Enhanced PCI IDE port, one Floppy Disk control port, two high speed Serial ports (UARTs), one multimode Parallel port, one PS/2 keyboard port, one PS/2 mouse port, one IR port, two USB ports, and support PC97 specification. It is designed to fit a high performance, Pentium 75 MHz to 233 MHz based solution for high-end and true GREEN-PC computer systems.

This system board supports the Peripheral Component Interconnect (PCI) Local Bus standard (PCI Specification Rev. 2.1 compliant). It not only breaks through the I/O bottlenecks if the traditional ISA mainboard, but also provides the performance needs for networking and multi-user environments.

2. SPECIFICATIONS

Chipset

Intel 82430TX (82439TX (MTXC), 82371AB(PIIX4)) and Winbond W83977TF-A (-AW / ATF-AW).

CPU (Jumper free)

Intel : Pentium processor and OverDrive processor (P54C / P54CS / P54CTB / P55C) 90 / 100 / 120 / 133 / 150 / 166 / 200 / 233 MHz.

Cyrix : 6x86 / 6x86L - P150+ / P166+ / P200+.

6x86MX - PR166 / PR200 / PR233 / PR266.

AMD : K6 / PR2-166 / PR2-200 / PR2-233 / PR2-266.

IDT : C6 - DS180 / DS200

CPU Voltage (Jumpers Setting or Jumper free)

(1).CPU I/O voltage : +3.4V DC or +3.5V DC.

(2).CPU CORE voltage: "+2.0V~+3.5V DC" for Jumpers Setting.

+2.1V, +2.8V, +2.9V, +3.2V,+3.4V, +3.5V DC for Jumperless.

System Clock (Jumper free)

60 / 66.6 / 75 MHz.

Memory

DRAM : Two banks, each bank could be single or double sided, 8MB up to 256MB.

Supports fast page mode (FPM), Extended Data Out (EDO), and SDRAM memory (Using 72-pin SIMM module x 4, and 168-pin DIMM module x 2).

DIMMs' operating voltage supports +3.3V DC.

SRAM : 256KB or 512KB pipelined burst SRAM on board.

BIOS

AWARD System BIOS. 128KB x 8 Flash ROM (for Plug & Play BIOS).

Expansion Slots

PCI Slots : 32-bit x 4 (All Master / Slave, PCI 2.1 Compliant).

ISA Slots : 16-bit x 3 (One PCI / ISA slot shared).

Supports AT and ATX Power connector.

ACPI (For ATX Power)

- 1.Power on by Panel-Switch, or Modem Ring-In.
- 2.Power on by Keyboard, PS/2 Mouse, or LAN Signal. (optional)
- 3.Power off (Soft-off) by OS or Panel-Switch.

 WOL (optional)

One WOL connector supports Wake-On-LAN (For ATX Power).

 IDE Ports

Two channel PIO and “Ultra DMA/33” Bus Master PCI IDE ports, which will connect maximum 4 IDE devices like IDE Hard Disk and ATAPI CD-ROM device. PIO Mode 4 transfer rate up to 14 Mbytes/s transfer rates and supports “Ultra DMA/33” mode transfers up to 33 Mbytes/sec.

 USB Ports

Two Universal Serial Bus (USB) ports.

 Super I/O Ports

- 1.Two high speed NS16C550 compatible Serial ports (UARTs).
- 2.One SPP / EPP / ECP mode Bi-directional parallel port.
- 3.One Floppy Disk Control port.

 IR Port

One HPSIR and ASKIR or Faster IR (optional) compatible Infrared port. One Consumer IR port (optional).

NOTE : Winbond W83977TF support HPSIR and ASKIR, W83977ATF support Faster IR and Consumer IR.

 Mouse and Keyboard

Supports PS/2 Mouse connector, PS/2 Keyboard connector (optional) and AT Keyboard connector.

 Support SB-LINK Connector

Support Creative PCI sound card, or others PCI sound card.

 Hardware Monitoring (optional)

- 1.Include Positive Voltage, CPU temperature, and two fan speed monitoring.
- 2.Supports speaker alarm beep during these condition failure.
- 3.Protects CPU by slowing down the CPU during the CPU overheat.

Software compatibility

MS-DOS, Windows NT, OS/2, UNIX, NOVELL, Windows, Windows 95, CAD/CAM, Memphis (Beta 2), ...etc, full tested.

 DIMENSION

Width & Length : 220 mm x 231 mm.

Height : 3/4 inches with components mounted.

PCB Thickness : 4-layers, 0.05 inches normal.

Weight : 20 ounces.

 ENVIRONMENT

Operating Temperature : 10°C to 40°C. (50°F to 104°F).

Require Airflow : 50 linear feet per minute across CPU.

Storage Temperature : -40°C to 70°C. (-40°F to 158°F).

Humidity : 0 to 90% noncondensing.

Altitude : 0 to 10,000 feet.

3. SYSTEM BOARD LAYOUT

3.1 PT-5ITB VER. 1.x

Explanation : All connectors, jumpers and components which are marked by a black point on the corner means the pin-1 side of the connector, jumper and component.

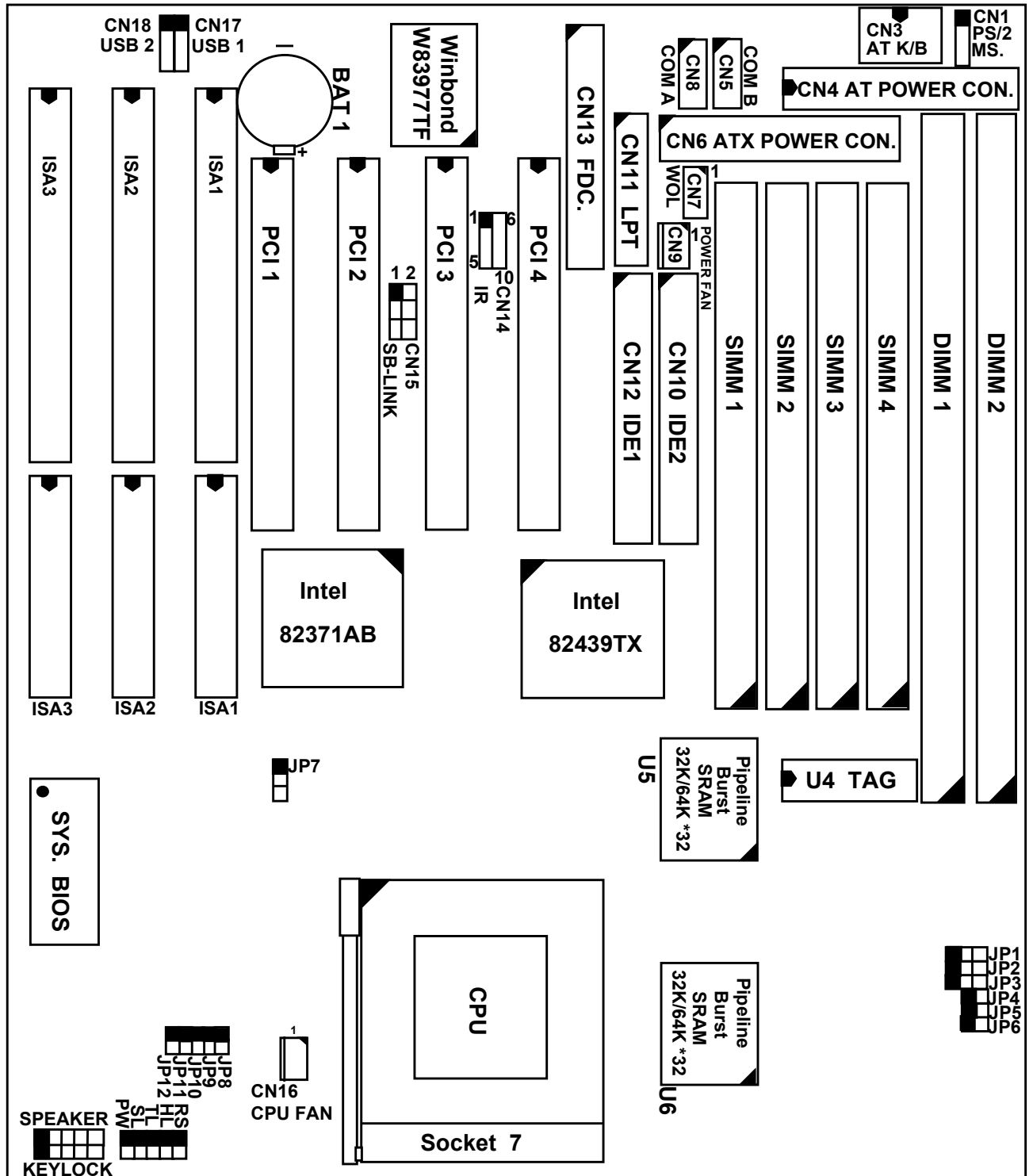

4. HARDWARE SETUP

This chapter explains how to configure the mainboard hardware. When you are installing the mainboard, you will have to make jumper settings and cable connections. Refer to this chapter whenever you install or reconfigure your system.

4.1 UNPACKING

The system board package should contain the following parts :

- The PT-5ITB system board.
- OPERATION MANUAL.
- Cable set for IDE and I/O device.

The mainboard contains electric sensitive components which can be easily damaged by static electricity, so the mainboard should be left in its original packing until it is installed.

Unpacking and installation should be done on a grounded anti-static mat. The operator should be wearing an anti static wristband, grounded at the same point as the anti-static mat.

Inspect the mainboard carton for obvious damage. Shipping and handling may cause damage to your board. Be sure there are no shipping and handling damages on the board before proceeding.

After opening the motherboard carton, extract the mainboard and place it only on a grounded anti-static surface with the component side up. Inspect the board again to see whether there is any damage.

Press down on all of the socket IC's to make sure that they are properly seated. Do this only with the board placed on a firm flat surface.

4.2 HARDWARE CONFIGURATION

Before the system board is ready for operating, the hardware must be configured to make sure it will work properly with different environment. To configure the PT-5ITB system board is a simple task, only a few jumpers, connectors, cables and sockets needs to be selected and installed. (For the detailed locations of each component please refer to the "system board layout figure" which appears in page 3-1.)

4.2.1 CONNECTORS

A connector is two or more pins that are used make connections to the system standard accessories (such as power, mouse, printer,...etc.). The following is a list of connectors on board, as well as descriptions of each individual connector.

(A) BAT1 Non-rechargeable battery (Using 3V Lithium battery : CR2032)

Pin # Assignment

- + Battery Positive
- Ground

(B) CN1 PS/2 Mouse converted connector

Pin # Assignment

1	●	1	Mouse Data
2		2	No Connection
3	●	3	Ground
4	●	4	+5V DC
5	●	5	Mouse Clock

(C) CN2 PS/2 Keyboard connector (optional)

Pin # Assignment

- 1 Keyboard Data
- 3 Ground
- 5 Keyboard Clock

Pin # Assignment

- 2 No Connection
- 4 +5V DC
- 6 No Connection

(D) CN3 AT Keyboard connector

Pin # Assignment

- 1 Keyboard Clock
- 3 No Connection
- 5 +5V DC

Pin # Assignment

- 2 Keyboard Data
- 4 Ground

(E) CN4 AT Power connector

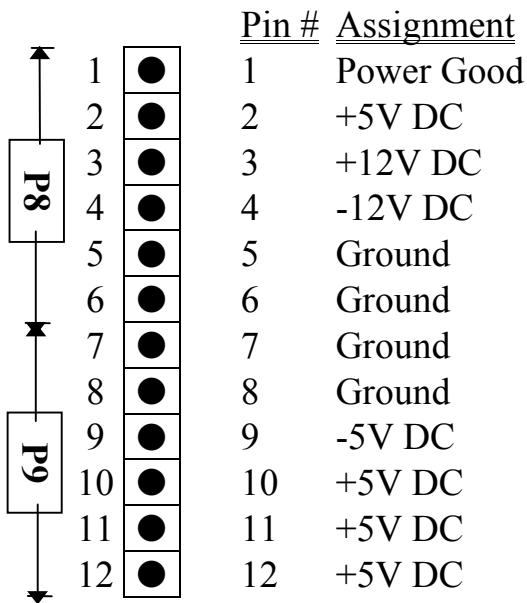

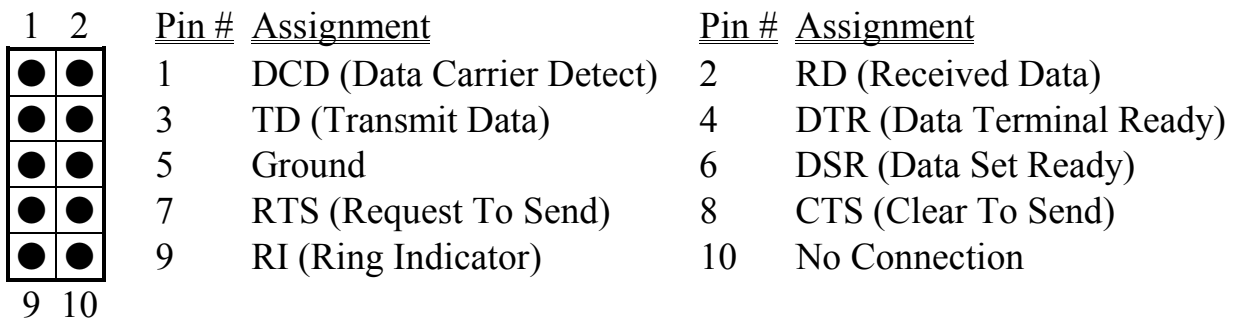

(F) CN5 COM B (Serial Port 2) connector
COM 1/2/3/4, selected by BIOS setup, using IRQ 3 or 4



(G) CN6 ATX Power connector











<u>Pin #</u>	<u>Assignment</u>	<u>Pin #</u>	<u>Assignment</u>
1	+3.3V DC	2	+3.3V DC
2	Ground	4	+5V DC
5	Ground	6	+5V DC
7	Ground	8	PW_OK
9	+5V DC	10	+12V DC
11	+3.3V DC	12	-12V DC
13	Ground	14	PS-ON
15	Ground	16	Ground
17	Ground	18	-5V DC
19	+5V DC	20	+5V DC

(H) CN7 WOL (Wake On LAN) connector



<u>Pin #</u>	<u>Assignment</u>
 1	5V standby
 2	Ground
 3	WOL Signal

(I) CN8 COM A (Serial Port 1) connector

COM 1/2/3/4, selected by BIOS setup, using IRQ4 or 3

<u>Pin #</u>	<u>Assignment</u>	<u>Pin #</u>	<u>Assignment</u>
 	1 DCD (Data Carrier Detect)	2	RD (Received Data)
 	3 TD (Transmit Data)	4	DTR (Data Terminal Ready)
 	5 Ground	6	DSR (Data Set Ready)
 	7 RTS (Request To Send)	8	CTS (Clear To Send)
 	9 RI (Ring Indicator)	10	No Connection
9 10			

(J) CN9 POWER FAN connector

<u>Pin #</u>	<u>Assignment</u>
 1	GND
 2	+12V DC
 3	SIN (Fan Sense Signal)

(K) CN10 IDE 2 connector (Secondary IDE Port, using IRQ15)

(L) CN11 Parallel Port Connector

(Supports SPP/EPP/ECP mode, using IRQ7 or IRQ5, ECP using DMA channel 3 or 1, selected by CMOS setup)

1	14	<u>Pin #</u>	<u>Assignment</u>	<u>Pin #</u>	<u>Assignment</u>
●	●	1	STROBE-	14	AUTO FEED-
●	●	2	Data Bit 0	15	ERROR-
●	●	3	Data Bit 1	16	INIT-
●	●	4	Data Bit 2	17	SLCT IN-
●	●	5	Data Bit 3	18	Ground
●	●	6	Data Bit 4	19	Ground
●	●	7	Data Bit 5	20	Ground
●	●	8	Data Bit 6	21	Ground
●	●	9	Data Bit 7	22	Ground
●	●	10	ACK-	23	Ground
●	●	11	BUSY	24	Ground
●	●	12	PE	25	Ground
●	●	13	SLCT	26	No Connection
13	26				

(M)CN12 IDE 1 connector (Primary IDE Port, using IRQ 14)

(N)CN13 Floppy Disk Control Port connector (Using IRQ6, DMA channel 2)

(O)CN14 IR / FIR (Infrared Rays) connector

	<u>Pin #</u>	<u>Assignment</u>
●	1	+5V DC
	2	No Connection (Fast IR Receive, optional for W83977ATF)
●	3	IR Receive
●	4	Ground
●	5	IR Transmit

(P) CN14 Consumer IR connector
(optional and available only while U10 using W83977ATF I/O Chip)

<u>Pin #</u>	<u>Assignment</u>
6	+5V DC
7	IR Transmit
8	Consumer IR Receive
9	Ground

(Q) CN15 SB-LINK connector
(For PCI bus sound cards. Such as Creative™ Labs EMU8008 sound chip)

<u>Pin #</u>	<u>Assignment</u>	<u>Pin #</u>	<u>Assignment</u>
1	GNT#	2	Ground
3	Key	4	REQ#
5	Ground	6	SERIRQ

(R) CN16 CPU Cooling Fan Power connector

<u>Pin #</u>	<u>Assignment</u>
1	Ground
2	+12V DC
3	Fan Sense Signal

(S) CN17 USB Port 1 (Universal Serial Bus port 1) connector

<u>Pin #</u>	<u>Assignment</u>
1	+5V DC (RED WIRE)
2	DATA- (WHITE WIRE)
3	DATA+ (GREEN WIRE)
4	Ground (BLACK WIRE)
5	Ground (BLACK WIRE)

(T) CN18 USB Port 2 (Universal Serial Bus port 2) connector

1	<u>Pin #</u>	<u>Assignment</u>
●	1	+5V DC (RED WIRE)
●	2	DATA- (WHITE WIRE)
●	3	DATA+ (GREEN WIRE)
●	4	Ground (BLACK WIRE)
●	5	Ground (BLACK WIRE)

(U) KEYLOCK Front Panel Power LED & Key-Lock connector

1	<u>Pin #</u>	<u>Assignment</u>
●	1	Pullup (+5V DC for Power LED)
●	2	No Connection
●	3	Ground
●	4	Keyboard Lock
●	5	Ground

(V) SPEAKER Speaker connector

1	<u>Pin #</u>	<u>Assignment</u>
●	1	+5V DC
●	2	No Connection
●	3	No Connection
●	4	Speaker Data Signal

(W) RS Reset Button connector

Open : No action

Short : System Reset

Pin # Assignment

Pin # Assignment

1 Ground

2 Reset Control

(X) HL IDE HDD LED connector

Pin # Assignment

Pin # Assignment

1 Pullup (+5V DC)

2 Signal Pin

(Y) TL Turbo LED connector
 Pin # Assignment
 1 Pullup (+5V DC)

Pin # Assignment
 2 Ground

(Z) SL Sleep LED connector

ATX Power Off	: LED Turn On
ATX Power On	: LED Turn Off
<u>Pin # Assignment</u>	<u>Pin # Assignment</u>
1 Signal Pin	2 Ground

(AA) PW

(a.) For ATX power

Front Panel Power Switch connector & External SMI button connector
 (selected by BIOS setup : Soft-off by PWR-BTTN)

1. Instant-Off

Once pressed : Power On

Next pressed : Power Off

2. Delay 4 Sec.

Once pressed : Power On

Next pressed : Suspend mode

Pressed and after 4 second : Power Off

(b.) For AT power

External SMI button connector (BIOS setup : Soft-off by PWR-BTTN must
 be setted Delay 4 Sec.)

Once pressed : Suspend mode.

Next pressed : Full on mode.

4.2.2 JUMPERS

A jumper is two, three or more pins which may or may not be covered by a plastic connector plug (mini-jumper). A jumper is used to select different system options. **Please make sure all jumpers at correct position before this system board used.**

(A) JP1, JP2, JP3, JP4, JP5, JP6 CPU type selection (For Jumpers Setting)

NOTE :

When JP1, JP2, JP3, JP4, JP5, JP6 are empty, then this mainboard is jumperfree for CPU type selection, so you must enter the system BIOS to setup the correct CPU type. Please you refer to this manual the page 5-6, the 5.6 CHIPSET FEATURES SETUP item.

(1) 60MHz x 1.5

JUMPERS			CPU TYPE	
	1	2	3	
1	○	○	●	JP1
1	○	○	●	JP2
1	●	○	○	JP3
1	●	●		JP4
1	●	●		JP5
1	●	●		JP6
				Intel 80502-90 PODP3V150 PODPMT60X150

(2) 66MHz x 1.5 / 66MHz x 3.5

JUMPERS			CPU TYPE	
	1	2	3	
1	○	○	●	JP1
1	○	○	●	JP2
1	○	○	●	JP3
1	●	●		JP4
1	●	●		JP5
1	●	●		JP6
				Intel 80502-100 80503-233 PODP3V166 PODPMT66X166 AMD K6/PR2-233 Cyrix 6x86 MX -PR266

(3) 60MHz x 2

JUMPERS			CPU TYPE	
	1	2	3	
1	○	○	●	JP1
1	○	○	●	JP2
1	●	○	○	JP3
1	○	○		JP4
1	●	●		JP5
1	●	●		JP6
				Intel 80502-120 Cyrix 6x86 / 6x86L -P150+

(4) 66MHz x 2

JUMPERS			CPU TYPE	
	1	2	3	
1	○	○	●	JP1
1	○	○	●	JP2
1	○	○	●	JP3
1	○	○		JP4
1	●	●		JP5
1	●	●		JP6
				Intel 80502-133 Cyrix 6x86 / 6x86L -P166+ 6x86MX-PR166

(5) 75MHz x 2

JUMPERS			CPU TYPE	
	1	2	3	
1	○	○	●	JP1
1	●	○	○	JP2
1	○	○	●	JP3
1	○	○		JP4
1	●	●		JP5
1	●	●		JP6
				Cyrix 6x86 / 6x86L -P200+ 6x86MX-PR200

(6) 60MHz x 2.5

JUMPERS			CPU TYPE	
	1	2	3	
1	○	○	●	JP1
1	○	○	●	JP2
1	●	○	○	JP3
1	○	○		JP4
1	○	○		JP5
1	●	●		JP6
				Intel 80502-150 Cyrix 6x86MX -PR166

(7) 66MHz x 2.5

JUMPERS			CPU TYPE	
	1	2	3	
1	○	○	●	JP1
1	○	○	●	JP2
1	○	○	●	JP3
1	○	○		JP4
1	○	○		JP5
1	●	●		JP6
				Intel 80502-166 80503-166 AMD K6/PR2-166 Cyrix 6x86MX -PR200

(8) 75MHz x 2.5

JUMPERS			CPU TYPE	
	1	2	3	
1	○	○	●	JP1
1	●	○	○	JP2
1	○	○	●	JP3
1	○	○		JP4
1	○	○		JP5
1	●	●		JP6
				Cyrix 6x86MX -PR233

(9) 60MHz x 3

JUMPERS			CPU TYPE	
	1	2	3	
1	○	○	●	JP1
1	○	○	●	JP2
1	●	○	○	JP3
1	●	●		JP4
1	○	○		JP5
1	●	●		JP6
				IDT C6-DS180

(10) 66MHz x 3

JUMPERS			CPU TYPE	
	1	2	3	
1	○	○	●	JP1
1	○	○	●	JP2
1	○	○	●	JP3
1	●	●		JP4
1	○	○		JP5
1	●	●		JP6
				Intel 80502-200 80503-200 IDT C6-DS200 AMD K6/PR2-200 Cyrix 6x86MX -PR233

(11) 75MHz x 3

JUMPERS			CPU TYPE	
	1	2	3	
1	○	○	●	JP1
1	●	○	○	JP2
1	○	○	●	JP3
1	●	●		JP4
1	○	○		JP5
1	●	●		JP6
				Cyrix 6x86MX -PR266

(12) 60MHz x 4

JUMPERS			CPU TYPE	
	1	2	3	
1	○	○	●	JP1
1	○	○	●	JP2
1	●	○	○	JP3
1	○	○		JP4
1	●	●		JP5
1	○	○		JP6

(13) 66MHz x 4

JUMPERS			CPU TYPE	
	1	2	3	
1	○	○	●	JP1
1	○	○	●	JP2
1	○	○	●	JP3
1	○	○		JP4
1	●	●		JP5
1	○	○		JP6
				AMD K6/PR2-266

(14) 75MHz x 4

JUMPERS			CPU TYPE	
	1	2	3	
1	○	○	●	JP1
1	●	○	○	JP2
1	○	○	●	JP3
1	○	○		JP4
1	●	●		JP5
1	○	○		JP6

(15) 66MHz x 4.5

JUMPERS			CPU TYPE	
	1	2	3	
1	○	○	●	JP1
1	○	○	●	JP2
1	○	○	●	JP3
1	○	○		JP4
1	○	○		JP5
1	○	○		JP6
				AMD K6/PR2-300

(16) 66MHz x 5

JUMPERS			CPU TYPE	
	1	2	3	
1	○	○	●	JP1
1	○	○	●	JP2
1	○	○	●	JP3
1	●	●		JP4
1	○	○		JP5
1	○	○		JP6

(B) JP8, JP9, JP10, JP11, JP12 CPU CORE voltage selection (for Jumpers Setting or Jumper free)

NOTE :

The CPU CORE voltage for Jumper free support 2.1V, 2.8V, 2.9V, 3.2V, 3.4V, 3.5V DC only, so if your CPU CORE voltage os not these voltage, please use those JP11, JP12, JP13, JP14, JP15 to set the correct CPU CORE voltage.

JUMPERS	CORE Voltage	IO Voltage	CPU TYPE	REMARKS
1 2 1 ● ● JP11	AUTO	AUTO		For Jumper free supports 2.1V, 2.8V 2.9V, 3.2V 3.4V, 3.5V
1 ● ● JP12				
1 ● ● JP13				
1 ● ● JP14				
1 ● ● JP15				

JUMPERS	CORE Voltage	IO Voltage	CPU TYPE	REMARKS
1 2 1 ○ ○ JP11	3.5V	3.5V	Cyrix 6x86	For Jumper free
1 ○ ○ JP12	3.5V	3.5V	IDT C6	
1 ○ ○ JP13				
1 ○ ○ JP14				
1 ○ ○ JP15				

JUMPERS	CORE Voltage	IO Voltage	CPU TYPE	REMARKS
1 2 1 ○ ○ JP11	3.4V	3.4V	Intel P54C (80502)	For Jumper free
1 ○ ○ JP12	3.4V	3.4V	Cyrix 6x86	
1 ○ ○ JP13				
1 ○ ○ JP14				
1 ● ● JP15				

JUMPERS	CORE Voltage	IO Voltage	CPU TYPE	REMARKS
1 2 1 ○ ○ JP11 1 ○ ○ JP12 1 ○ ○ JP13 1 ● ● JP14 1 ○ ○ JP15	3.3V	3.3V	IDT C6	For Jumpers Sitting

JUMPERS	CORE Voltage	IO Voltage	CPU TYPE	REMARKS
1 2 1 ○ ○ JP11 1 ○ ○ JP12 1 ○ ○ JP13 1 ● ● JP14 1 ● ● JP15	3.2V	3.3V	AMD K6/PR2-233	For Jumper free

JUMPERS	CORE Voltage	IO Voltage	CPU TYPE	REMARKS
1 2 1 ○ ○ JP11 1 ○ ○ JP12 1 ● ● JP13 1 ○ ○ JP14 1 ○ ○ JP15	3.1V	3.3V		For Jumpers Setting

JUMPERS	CORE Voltage	IO Voltage	CPU TYPE	REMARKS
1 2 1 ○ ○ JP11 1 ○ ○ JP12 1 ● ● JP13 1 ○ ○ JP14 1 ● ● JP15	3.0V	3.3V		For Jumpers Sitting

JUMPERS	CORE Voltage	IO Voltage	CPU TYPE	REMARKS
1 2 1 ○ ○ JP11	2.9V	3.3V	AMD K6/PR2-166	For Jumper free
1 ○ ○ JP12	2.9V	3.3V	AMD K6/PR2-200	
1 ● ● JP13	2.9V	3.3V	Cyrix 6x86MX	
1 ● ● JP14				
1 ○ ○ JP15				

JUMPERS	CORE Voltage	IO Voltage	CPU TYPE	REMARKS
1 2 1 ○ ○ JP11	2.8V	3.3V	Intel P55C (80503)	For Jumper free
1 ○ ○ JP12	2.8V	3.3V	Cyrix 6x86L	
1 ● ● JP13				
1 ● ● JP14				
1 ● ● JP15				

JUMPERS	CORE Voltage	IO Voltage	CPU TYPE	REMARKS
1 2 1 ○ ○ JP11	2.7V	3.3V		For Jumpers Setting
1 ● ● JP12				
1 ○ ○ JP13				
1 ○ ○ JP14				
1 ○ ○ JP15				





JUMPERS	CORE Voltage	IO Voltage	CPU TYPE	REMARKS
1 2 1 ○ ○ JP11	2.6V	3.3V		For Jumpers Setting
1 ● ● JP12				
1 ● ● JP13				
1 ○ ○ JP14				
1 ● ● JP15				





JUMPERS	CORE Voltage	IO Voltage	CPU TYPE	REMARKS
1 2 1 ○ ○ JP11 1 ● ● JP12 1 ○ ○ JP13 1 ● ● JP14 1 ○ ○ JP15	2.5V	3.3V		For Jumpers Setting

JUMPERS	CORE Voltage	IO Voltage	CPU TYPE	REMARKS
1 2 1 ○ ○ JP11 1 ● ● JP12 1 ○ ○ JP13 1 ● ● JP14 1 ● ● JP15	2.4V	3.3V		For Jumpers Setting

JUMPERS	CORE Voltage	IO Voltage	CPU TYPE	REMARKS
1 2 1 ○ ○ JP11 1 ● ● JP12 1 ● ● JP13 1 ○ ○ JP14 1 ○ ○ JP15	2.3V	3.3V		For Jumpers Setting

JUMPERS	CORE Voltage	IO Voltage	CPU TYPE	REMARKS
1 2 1 ○ ○ JP11 1 ● ● JP12 1 ● ● JP13 1 ○ ○ JP14 1 ● ● JP15	2.2V	3.3V		For Jumpers Setting

JUMPERS	CORE Voltage	IO Voltage	CPU TYPE	REMARKS
1 2	2.1V	3.3V		For Jumper free
1  JP11				
1  JP12				
1  JP13				
1  JP14				
1  JP15				

JUMPERS	CORE Voltage	IO Voltage	CPU TYPE	REMARKS
1 2	2.0V	3.3V		For Jumpers Sitting
1  JP11				
1  JP12				
1  JP13				
1  JP14				
1  JP15				

(C) JP7 Clear CMOS button

Pin # Function

1-2 Normal Operation

2-3 Clear CMOS

4.3 INSTALLING A CPU IN THE ZIF SOCKET

The Intel Socket 7 incorporated in the mainboard specifications, is specially designed for the Pentium processor. While inserting the Pentium processor onto Socket 7, certain precautionary steps must be followed. The following diagrams of demonstration and explanation are worth of your note.

1. Make sure the ZIF socket level is up.

To raise the lever, pull it out to the side a little and raise it as far as it will go. Pin 1 is at the arm corner.

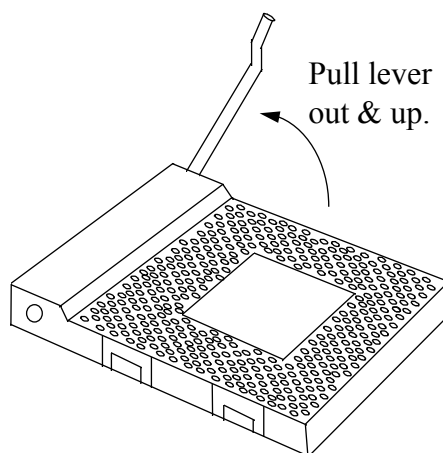

2. Align the CPU and socket pin 1 corners. Match the processor corner containing the blunt edge and the white dot to the socket corner with the distinctive pin arrangement. The pins on the bottom should align with the inner 3 rings of holes in the socket, then place the CPU in the socket. It should insert easily. If it doesn't, pull the level up a little more.

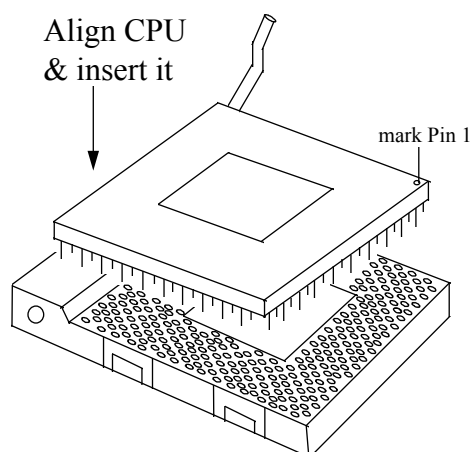

3. Press the lever down. The plate will slide forward. You will feel some resistance as the pressure starts to secure the CPU in the socket. When the CPU is installed, the lever should snap into place at the side of the socket.

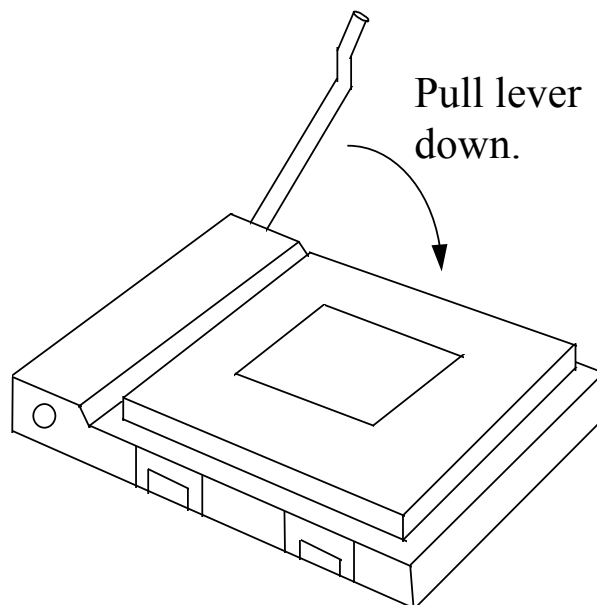

4.4 INSTALLATION OF CPU COOLING FAN

Improper installation of CPU cooling fan will cause serious damage to the motherboard. Please follow the procedures carefully:

1. There is a metal clip attached to the CPU cooler as shown below.

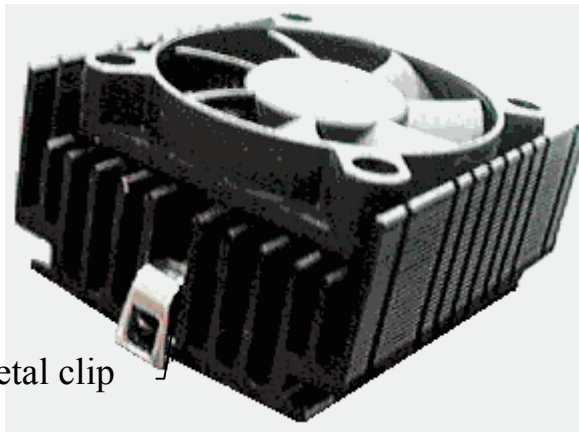

Metal clip

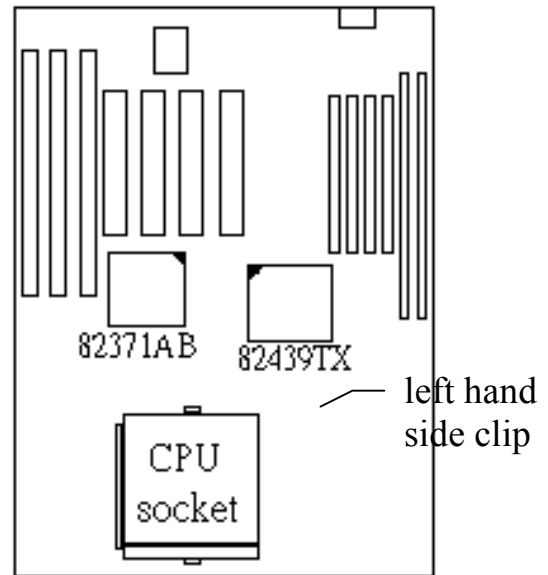

2. Place the CPU cooler squarely on the top of CPU.

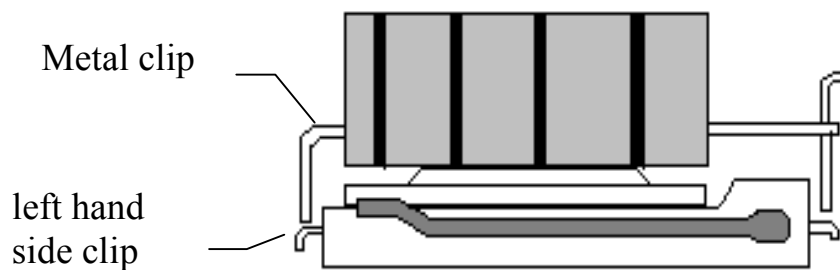

3. Hook the left hand side clip on the CPU socket first.

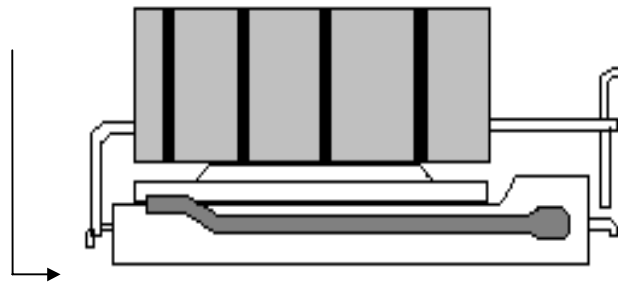

4. Push down the opposite side of the metal clip firmly and carefully to lock the cooler in place.

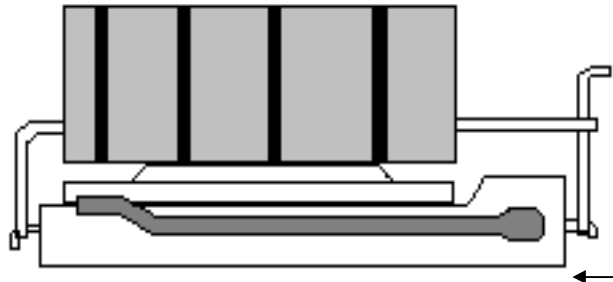

4.5 UPGRADING SYSTEM MEMORY

The PT-5ITB mainboard can use up to four 72-pin SIMM sockets (SIMM1, SIMM2, SIMM3, SIMM4), and two 168-pin DIMM sockets (DIMM1, DIMM2). Upgradable from 8MB to 256MB.

4.5.1 Installing a SIMM module

1.

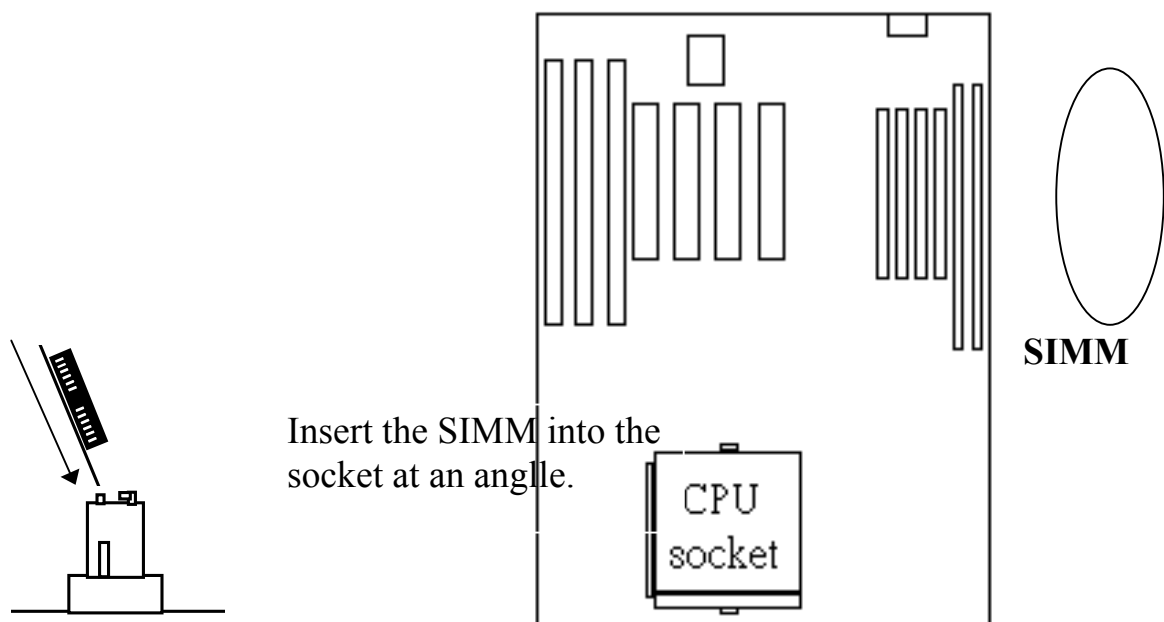

2.

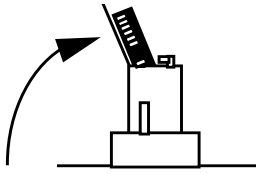

Press it forward onto the positioning pins.

3.

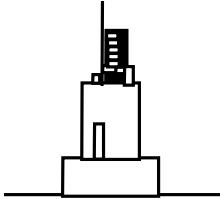

The retaining clips should fit over the edge and hold the SIMM in place.

4.5.2 Installing a DIMM Module

1.

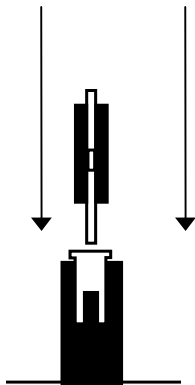

Insert the DIMM module into the socket at an angle.

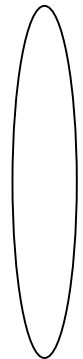
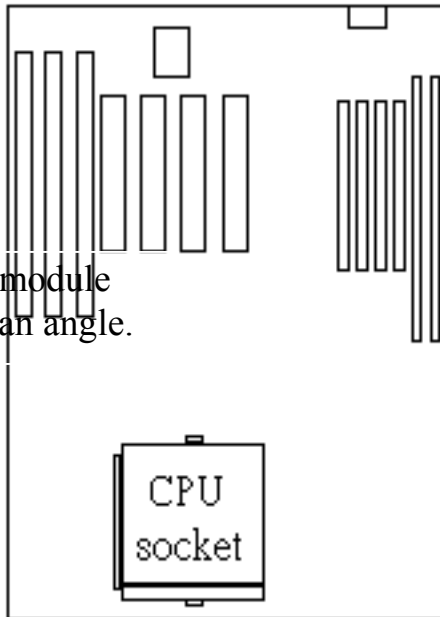

DIMM

2. Put out the DIMM module from the DIMM socket.

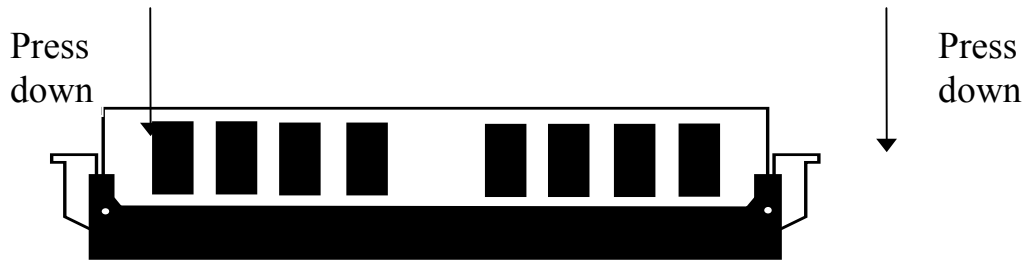

4.5.3 Memory Module Installing

The speed of FPM DRAMs must be used 70ns or faster than 70ns, the speed of EDO DRAMs and SDRAMs must be used 60ns or faster than 60ns.

SIMMs' and DIMM's operating voltage :

- (1) SIMM1- SIMM4 : +5V DC
- (2) DIMM1- DIMM2 : +3.3V DC

DRAM bank can be populated in any order (bank 0 does not have to be populated before bank 1). Within any given bank, the SIMMs must be the same size. Among the two banks, SIMM (DIMM) densities can be mixed in any order. EDO, FPM and SDRAMs can be mixed between SIMMs (DIMM), a given SIMM (DIMM) must contain only one type of DRAM. When DRAM types are mixed each SIMM (DIMM) runs optimized for that particular type of DRAM.

There is no jumper needed for DRAM configuration, DRAMs type and size will be detected by system BIOS automatically.

The following table provides the possible combinations for DRAM memory installation.

Bank 0		Bank 1	
SIMM1 and SIMM2	DIMM1	SIMM3 and SIMM4	DIMM2
Single-sided	Empty	Single-sided	Empty
Double-sided	Empty	Double-sided	Empty
Empty	Single-sided	Empty	Single-sided
Empty	Double-sided	Empty	Double-sided

Note : We strong recommend, don't install 5V SIMM module and 3.3V DIMM module at the same time.

5. AWARD BIOS SETUP

5.1 GETTING STARTED

When the system is first powered on or reset, the BIOS will enter the Power-On Self Test routines (POST : Display a copyright message on the screen followed by a diagnostics and initialization procedure.) (If an EGA or VGA card is installed, the copyright message of the video card maybe displayed on the screen first.) The BIOS will indicate any error or malfunction by a series of beeps or display the error message on screen.

Normally, the simulate figure 5-1 will display on the screen when the system is powered on.

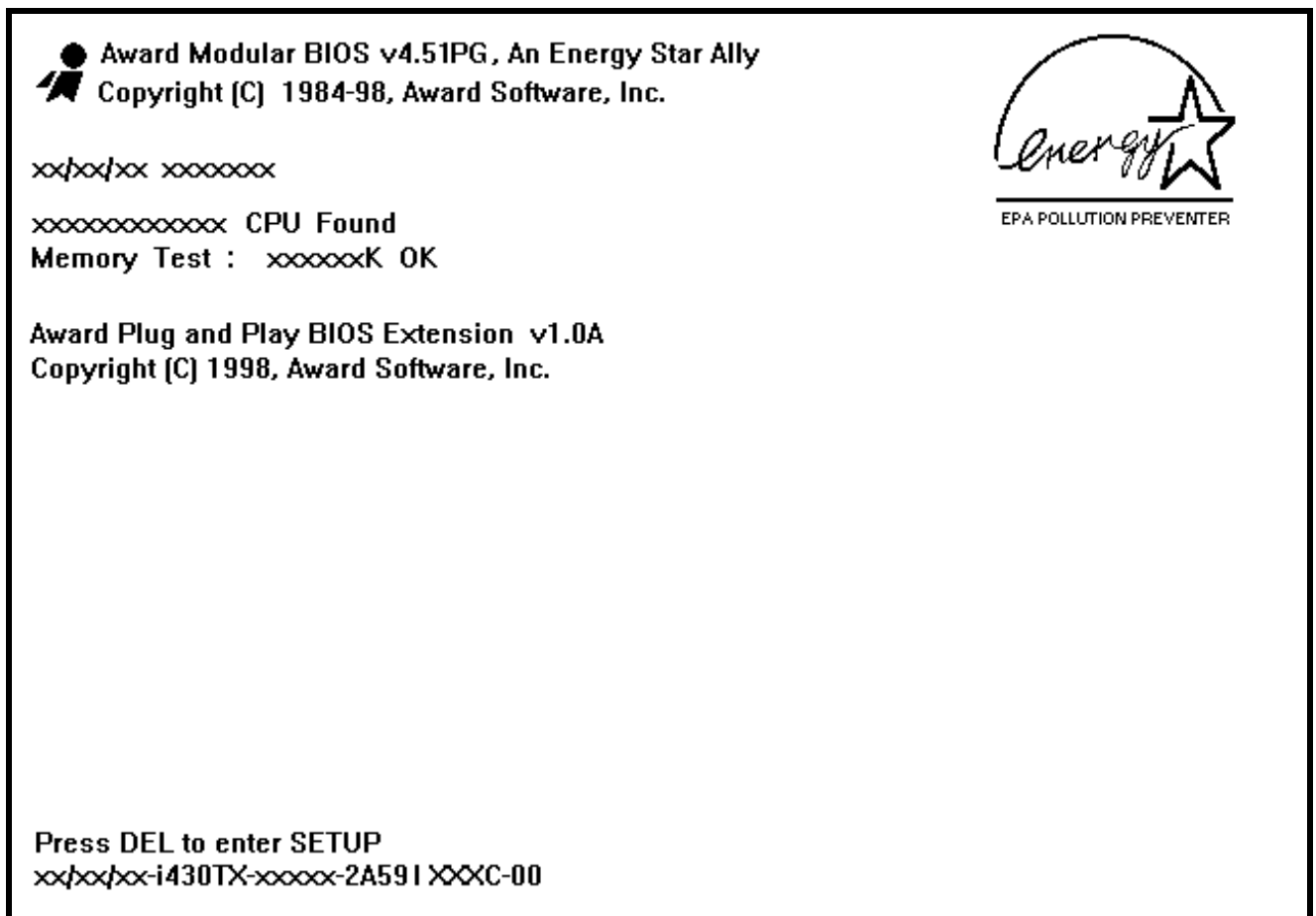

Fig. 5-1 Initial Power-On screen.

After the POST routines are completed, the following message appears :

“ Press **DEL** to enter SETUP ”

To execute the Award BIOS Setup program, press **DEL** key. The simulate screen in figure 5-2 MAIN MENU will be displayed at this time.

5.2 MAIN MENU

ROM PCI / ISA BIOS (2A59IXXX)
CMOS SETUP UTILITY
AWARD SOFTWARE, INC.

STANDARD CMOS SETUP	SUPERVISOR PASSWORD
BIOS FEATURES SETUP	USER PASSWORD
CHIPSET FEATURES SETUP	IDE HDD AUTO DETECTION
POWER MANAGEMENT SETUP	HDD LOW LEVEL FORMAT
PNP/PCI CONFIGURATION	SAVE & EXIT SETUP
INTEGRATED PERIPHERALS	EXIT WITHOUT SAVING
LOAD SETUP DEFAULTS	
ESC : Quit	↑↓←→ : Select Item
F10 : Save & Exit Setup	(Shift) F2 : Change Color
Time, Date, Hard Disk Type ...	

Fig. 5-2 CMOS SETUP MAIN MENU screen.

5.3 CONTROL KEYS

Listed below is an explanation of the keys displayed at the bottom of the screens accessed through the BIOS SETUP program :

- Arrow Keys** : Use the arrow keys to move the cursor to the desired item.
- Enter** : To select the desired item.
- F1** : Display the help screen for the selected feature.
- (Shift)F2** : To change the screen color, total 16 colors.
- ESC** : Exit to the previous screen.
- PgUp(-)/PgDn(+)** : To modify the default value of the options for the highlighted feature.
- F5** : Retrieves the previous CMOS values from CMOS, only for the current option page setup menu.
- F7** : Loads the SETUP default values from BIOS default table, only for the current option page setup menu.
- F10** : Save all changes made to CMOS RAM, only for the MAIN MENU.

The following pages will show the simulate screens of CMOS SETUP, each figure contains the setup items and the default settings of them. Below each figure may or may not be contained a lists of function description for commonly used settings. For the other settings function description you needed, please fell free to contact with your supplier.

5.4 STANDARD CMOS SETUP

ROM PCI / ISA BIOS (2A59IXXX)
STANDARD CMOS SETUP
AWARD SOFTWARE, INC.

Date (mm : dd : yy) Fri Feb 13 1998		Time (hh : mm : ss) : 08 : 35 : 45																
HARD DISKS	TYPE	SIZE	CYLS	HEAD	PRECOMP	LANDZ	SECTOR	MODE										
Primary Master	Auto	0	0	0	0	0	0	Auto										
Primary Slave	None	0	0	0	0	0	0	-----										
Secondary Master	Auto	0	0	0	0	0	0	Auto										
Secondary Slave	None	0	0	0	0	0	0	-----										
Drive A : 1.44M, 3.5 in.				<table border="1"> <tr> <td>Base Memory</td> <td>: 640 K</td> </tr> <tr> <td>Extended Memory</td> <td>: xxxxxx K</td> </tr> <tr> <td>Other Memory</td> <td>: xxxxxx K</td> </tr> <tr> <td colspan="2"><hr/></td> </tr> <tr> <td>Total Memory</td> <td>: xxxxxx K</td> </tr> </table>					Base Memory	: 640 K	Extended Memory	: xxxxxx K	Other Memory	: xxxxxx K	<hr/>		Total Memory	: xxxxxx K
Base Memory	: 640 K																	
Extended Memory	: xxxxxx K																	
Other Memory	: xxxxxx K																	
<hr/>																		
Total Memory	: xxxxxx K																	
Drive B : None																		
Floppy 3 Mode Support : Disabled																		
Video : EGA/VGA																		
Halt On : All Errors																		
ESC : Quit		↑↓←→ : Select Item		PU/PD/+/- : Modify														
F1 : Help		(Shift)F2 : Change Color																

Fig. 5-3 STANDARD CMOS SETUP screen.

MODE:

For IDE hard disks, this BIOS provides three modes to support both normal size IDE hard disks and also disks size larger the 528MB :

- **NORMAL** : For IDE hard disks size smaller then 528MB.
- **LBA** : For IDE hard disks size larger then 528MB and up to 8.4GB (Giga Bytes) that use Logic Block Addressing (LBA) mode.
- **Large** : For IDE hard disks size larger then 528MB that do not use LBA mode. Large mode is a new specification which may not be fully supported by all operation systems. Now it can only be used with the MS-DOS and is uncommon.

Note : Some OSes (like SCO-UNIX) must use "NORMAL" for installation.

5.5 BIOS FEATURES SETUP

ROM PCI / ISA BIOS (2A59IXXX)
 BIOS FEATURES SETUP
 AWARD SOFTWARE, INC.

Virus Warning	: Disabled	Video BIOS Shadow	: Enabled
CPU Internal Cache	: Enabled	C8000-CBFFF Shadow	: Disabled
External Cache	: Enabled	CC000-CFFFF Shadow	: Disabled
Quick Power On Self Test	: Enabled	D0000-D3FFF Shadow	: Disabled
Boot Sequence	: A,C,SCSI	D4000-D7FFF Shadow	: Disabled
Swap Floppy Drive	: Disabled	D8000-DBFFF Shadow	: Disabled
Boot Up Floppy Seek	: Enabled	DC000-DFFFF Shadow	: Disabled
Boot Up NumLock Status	: On		
Boot Up System Speed	: High		
Gate A20 Option	: Fast		
Typematic Rate Setting	: Disabled		
Typematic Rate (Chars/Sec)	: 6		
Typematic Delay (Msec)	: 250		
Security Option	: Setup		
PCI/VGA Palette Snoop	: Disabled		
OS Select For DRAM > 64MB	: Non-OS2	ESC : Quit	↑↓←→ : Select Item
PS/2 mouse function control	: Enabled	F1 : Help	PU/PD/+/- : Modify
		F5 : Old Values (Shift)	F2 : Color
		F7 : Load Setup Defaults	

Fig. 5-4 BIOS FEATURES SETUP screen.

Virus Warning :

This feature flashes on the screen. During and after the system boots up, any attempt to write to the boot sector or partition table of the hard disk drive will halt the system and an error message will appear, in the mean time, you can run anti-virus program to locate the problem. Default values is "Disabled".

Enabled : Activate automatically when the system boots up causing a warning message to appear when anything attempts to access the boot sector or hard disk partition table.

Disabled : No warning message to appear when anything attempts to access the boot sector or hard disk partition table.

CPU Internal Cache :

This option enables CPU's internal (L1) cache memory. If you want to use the internal (L1) cache memory and external (L2) cache memory, this option must be enabled.

External Cache :

This option enables L2 (secondary) external cache memory. If none external cache memory on board you must set this option to "disabled", otherwise, you can select enabled or disabled.

5.6 CHIPSET FEATURES SETUP

ROM PCI / ISA BIOS (2A59IXXX)
CHIPSET FEATURES SETUP
AWARD SOFTWARE, INC.

Auto Configuration	: Enabled	<i>CPU Type</i>	: <i>Intel P55C</i>
DRAM Timing	: 60 ns	<i>CPU Vcore</i>	: <i>2.80V</i>
DRAM Leadoff Timing	: 10/6/3	<i>CPU Speed</i>	: <i>166 (66*2.5)</i>
DRAM Read Burst (EDO/FP)	: x222/x333	Auto Detect DIMM/PCI Clk	: Enabled
DRAM Write Burst Timing	: x222	Spread Spectrum	: Disabled
Fast EDO Lead Off	: Enabled	CPU Warning Temperature	: Disabled
Refresh RAS# Assertion	: 4 Clks	Current CPU Temperature	: 29°C/84°F
Fast RAS To CAS Delay	: 3	Current CPUFAN1 Speed	: 0 RPM
DRAM Page Idle Timer	: 2Clks	Current CPUFAN2 Speed	: 0 RPM
DRAM Enhanced Paging	: Enabled	Current Vin(V)	: 2.81V
Fast MA to RAS# Delay	: 2 Clks		
SDRAM(CAS Lat/RAS-to-CAS)	: 3/3		
SDRAM Speculative Read	: Disabled		
System BIOS Cacheable	: Disabled		
Video BIOS Cacheable	: Disabled	ESC : Quit	↑↓←→ : Select Item
8 Bit I/O Recovery Time	: 1	F1 : Help	PU/PD/+/- : Modify
16 Bit I/O Recovery Time	: 2	F5 : Old Values (Shift)	F2 : Color
Memory Hole At 15M-16M	Disabled	F7 : Load Setup Defaults	
PCI 2.1 Compliance	Disabled		

Fig. 5-5 CHIPSET FEATURES SETUP screen.

WARNING : *The CHIPSET FEATURES SETUP in this screen are provided so that technical professionals can modify the Chipset to suit their requirement. If you are not a technical engineer, do not use this program.*

NOTE :

CPU Type : IDT-C6

CPU Vcore: 3.5V

CPU Speed: 180 (60*3)

For IDT-C6 CPU, the BIOS only supports 3.5V, so if your IDT-C6 CPU Vcore voltage is not 3.5V DC, please refer to this manual the page 4-13, to set the correct CPU Vcore voltage.

For AMD K6 CPU, the BIOS provides 2.9V and 3.2V DC.

CPU Type : AMD K6

CPU Type : AMD K6

CPU Type : AMD K6

CPU Vcore: 2.9V

CPU Vcore : 2.9V

CPU Vcore : 3.2V

CPU Speed: 166 (66*2.5)

CPU Speed : 200 (66*3)

CPU Speed :

233

(66*3.5)

The CPU Vcore default values is "2.9V". If your CPU Vcore voltage is not 2.9V, press **PgUp** or **PgDn** key, to set the correct CPU Vcore voltage.

For Cyrix 6x86 CPU, the BIOS provides 3.4V and 3.5V DC.

CPU Type : Cyrix 6x86

CPU Vcore: 3.5V

CPU Speed: P166+ (66*2)

The CPU Vcore default values is "3.5V". If your CPU Vcore voltage is not 3.5V, to modify the default value of the options, to set the correct CPU Vcore voltage.

Auto Configuration :

When "Enabled", this parameter automatically enters and locks some of the optimum values for the chipset and CPU. Otherwise, this parameter allows the values of these parameters could be changed.

DRAM Timing :

When "Auto Configuration" is "Enabled", this parameter provides two suit of the optimum values for the chipset and CPU, depends on the DRAMs' speed, you can select "70 ns" or "60 ns", but the first value maybe caused your system more stable.

5.7 POWER MANAGEMENT SETUP

ROM PCI / ISA BIOS (2A59IXXX)
 POWER MANAGEMENT SETUP
 AWARD SOFTWARE, INC.

Power Management	: User Define	** Reload Global Timer Events **	
PM Control by APM	: Yes	IRQ[3-7 , 9-15], NMI	: Enabled
Video Off Method	: Blank Screen	Primary IDE 0	: Disabled
Video Off After	: Standby	Primary IDE 1	: Disabled
MODEM Use IRQ	: 3	Secondary IDE 0	: Disabled
Doze Mode	: Disabled	Secondary IDE 1	: Disabled
Standby Mode	: Disabled	Floppy Disk	: Disabled
Suspend Mode	: Disabled	Serial Port	: Enabled
HDD Power Down	: Disabled	Parallel Port	: Disabled
VGA Active Monitor	: Enabled		
Soft-Off by PWR-BTTN	: Delay 4 Sec.		
Resume by Ring	: Enabled		
Resume by Alarm	: Disabled		
IRQ 8 Break Suspend	: Disabled		
		ESC	: Quit
		F1	: Help
		F5	: Old Values
		F7	: Load Setup Defaults
		↑↓←→	: Select Item
		PU/PD/+/-	: Modify
		(Shift)F2	: Color

Fig. 5-6 POWER MANAGEMENT SETUP screen.

WARNING :

The POWER MANAGEMENT SETUP in this screen are provided so that technical professionals can modify the Chipset to suit their requirement. If you are not a technical engineer, do not use this program!

Power management :

This setting controls the Power Management functions. "User Define" allows the values of all parameters could be modified. "Min Saving" and "Max Saving" fixed the values of four parameters, including "Doze Mode", "Standby Mode", "Suspend Mode" and "HDD Power Down". "Disable" disabled all Power Management functions. Default is "User Define".

5.8 PNP/PCI CONFIGURATION

ROM PCI / ISA BIOS (2A59IXXX)
PNP/PCI CONFIGURATION
AWARD SOFTWARE, INC.

PNP OS Installed	: No	PCI IDE IRQ Map To	: PCI-AUTO
Resources Controlled By	: Manual	Primary IDE INT#	: A
Reset Configuration Data	: Disabled	Secondary IDE INT#	: B
IRQ-3 assigned to	: Legacy ISA	Used MEM base addr	: N/A
IRQ-4 assigned to	: Legacy ISA		
IRQ-5 assigned to	: PCI/ISA PnP		
IRQ-7 assigned to	: Legacy ISA		
IRQ-9 assigned to	: PCI/ISA PnP		
IRQ-10 assigned to	: PCI/ISA PnP		
IRQ-11 assigned to	: PCI/ISA PnP		
IRQ-12 assigned to	: Legacy ISA		
IRQ-14 assigned to	: Legacy ISA		
IRQ-15 assigned to	: Legacy ISA		
DMA-0 assigned to	: PCI/ISA PnP		
DMA-1 assigned to	: PCI/ISA PnP	ESC : Quit	↑↓←→ : Select Item
DMA-3 assigned to	: PCI/ISA PnP	F1 : Help	PU/PD/+/- : Modify
DMA-5 assigned to	: PCI/ISA PnP	F5 : Old Values	(Shift)F2 : Color
DMA-6 assigned to	: PCI/ISA PnP	F7 : Load Setup Defaults	
DMA-7 assigned to	: PCI/ISA PnP		

Fig. 5-7 PNP/PCI CONFIGURATION setup screen.

WARNING :

The PNP/PCI CONFIGURATION in this screen are provided so that technical professionals can modify the Resources Configuration to suit their requirement. If you are not a technical engineer, do not use this program!

Resources Controlled by :

Manual : The system BIOS will not reference the ESCD for IRQ & DMA information's. Instead, it will reference the items in this setup menu for assigning IRQ & DMA, but for I/O and Memory space the system BIOS still refer to the ESCD.

Auto : The system BIOS will reference the ESCD all legacy information's.

Reset Configuration Data :

Disabled : The system BIOS will do nothing.

Enabled : The system BIOS will clear/reset the ESCD during "POST". After clearing the ESCD, the system BIOS will then change this item's value back to "Disable", otherwise, the ESCD will become useless.

IRQ # / DMA # assigned to :

Legacy : The system BIOS will skip never assign this specified IRQ/DMA resource to ISA PCI or ISA PnP devices.

PCI/ISA : All items set to this value will make the specified IRQ/DMA have a chance to PnP be assigned to PCI or ISA PnP devices.

PCI IDE IRQ Map To : (for off-board PCI IDE cards)

PCI-AUTO : The BIOS will scan for PCI IDE devices and determine the location of the PCI IDE device, then assign IRQ 14 for primary IDE INT #, and assign IRQ 15 for secondary IDE INT #.

ISA : The BIOS will not assign any IRQs even if PCI IDE card is found. Because some IDE cards connect the IRQ 14 and 15 directly from ISA slot through a card. (This card is called Legacy Header)

PCI-SLOT1 : For the specified slot, the BIOS will assign IRQ 14 for primary IDE INT #, to and assign IRQ 15 for secondary IDE INT #.

PCI-SLOT4

Note : No matter the item "Resources Controlled By" is set to "Manual" or "Auto", the system BIOS assign IRQs to PCI devices from high to low. For ISA PnP devices, the sequence is from low to high. IRQ 12 is always the last one available for PCI/PnP due to IRQ 12 is always reserves for the PS/2 mouse.

Explanation for proper nouns :**PnP device :**

- Device that has Plug & Play compatibility. That means it can request for DMA, IRQ, I/O and Memory from the PnP BIOS and all these requests can be relocatable. In other words, these devices do not utilize any fixed resources.
- All PCI devices and all ISA PnP devices are PnP devices.

Legacy device :

- A legacy device is a device that all its resources are fixed by hardware (or selected by jumpers).
- All ISA Non-PnP devices are legacy device.

Extended System Configuration Data (ESCD) :

- A media between the user and the system BIOS for passing the legacy devices information's. These information's are stored in the onboard NVRAM (flash ROM).

5.9 INTEGRATED PERIPHERALS

ROM PCI/ISA BIOS (2A59IXXX)
INTEGRATED PERIPHERALS
AWARD SOFTWARE, INC.

IDE HDD Block Mode	: Enabled	UART Mode Select	: Normal
IDE Primary Master PIO	: Auto		
IDE Primary Slave PIO	: Auto		
IDE Secondary Master PIO	: Auto	Onboard Parallel Port	: 378 / IRQ 7
IDE Secondary Slave PIO	: Auto	Parallel Port Mode	: SPP
IDE Primary Master UDMA	: Auto		
IDE Primary Slave UDMA	: Auto		
IDE Secondary Master UDMA	: Auto		
IDE Secondary Slave UDMA	: Auto		
On-Chip Primary PCI IDE	: Enabled		
On-Chip Secondary PCI IDE	: Enabled		
USB Keyboard Support	: Disabled		
		ESC : Quit	↑↓←→ : Select Item
Onboard FDC Controller	: Enabled	F1 : Help	PU/PD/+/- : Modify
Onboard Serial Port 1	: 3F8 / IRQ 4	F5 : Old Values	(Shift)F2 : Color
Onboard Serial Port 2	: 2F8 / IRQ 3	F7 : Load Setup Defaults	

Fig. 5-8 INTEGRATED PERIPHERALS setup screen.

WARNING :

The INTEGRATED PERIPHERALS in this screen are provided so that technical professionals can modify the Chipset to suit their requirement. If you are not a technical engineer, do not use this program!

Onboard Parallel Mode :

This setting determines the onboard parallel port (CN11) transmission mode. Supports either SPP, EPP, ECP, or ECP+EPP.

5.10 LOAD SETUP DEFAULTS

This option loads the SETUP default values from BIOS default table. By pressing “Enter” key, while “LOAD SETUP DEFAULTS” is highlighted, then presses “Y” and “Enter” key. The SETUP default values will be loaded. The SETUP default settings are the best-case values that should optimize system performance and increase system stability. If CMOS RAM is corrupted, the SETUP DEFAULTS settings are loaded automatically.

5.11 SUPERVISOR PASSWORD / USER PASSWORD

Type the Password and press “Enter”, then repeat. Enters up to eight alphanumeric characters. By pressing “Enter” key twice, without any alphanumeric character enters, the PASSWORD will be disabled.

5.12 IDE HDD AUTO DETECTION

By pressing “Enter” key, while “IDE HDD AUTO DETECTION” is highlighted causes the system to attempt to detect the type of hard disk. If successful, then presses “Y” (or 1, 2, ...) and “Enter” key, it fills in the remaining fields on this menu and the correlated fields in the STANDARD CMOS SETUP menu.

5.13 HDD LOW LEVEL FORMAT

This option provides an utility program for IDE HDD Low Level Format. Performing the Hard Disk Format will destroy any data on the Hard Disk. Back up the Hard Disk(s) before actually performing of these routines.

*Note : These routines are not valid for a **SCSI** Disk Drive.*

5.14 SAVE & EXIT SETUP

This option saves all setup values to CMOS RAM & EXIT SETUP routine, by moving the cursor to “SAVE & EXIT SETUP” and pressing “Enter” key, then types “Y” and “Enter” key, the values will be saved, the setup program will be terminated and the system will be reboot.

5.15 EXIT WITHOUT SAVING

This option exits setup routine without saving any changed values to CMOS RAM, by moving the cursor to “EXIT WITHOUT SAVING” and pressing “Enter” key, then types “Y” and Enter“ key, the setup program will be terminated and the system will be reboot.

