



User's Manual

An Intel 815E chipset based
Socket370 mainboard

TRADEMARK

All products and company names are trademarks or registered trademarks of their respective holders.

These specifications are subject to change without notice.

*Manual Revision 1.1
November 22, 2000*

Table of Contents

	<i>Page</i>
<i>Section 1</i>	<i>Introduction</i>
	Components Checklist 1-1
	<i>Overview</i>
	Intel Celeron processors (P.P.G.A.) 370 1-2
	Intel Coppermine processors (FC-PGA) 370 1-3
	Intel® 815 Series Chipset Feature 1-4
	Accelerated Graphics Port 1-6
	Ultra ATA/66/100 1-6
	Hardware Monitoring 1-6
	Mainboard Form-Factor 1-7
	I/O Shield Connector 1-8
	Power-On/Off (Remote) 1-8
	System Block Diagram 1-9
<i>Section 2</i>	<i>Features</i>
	Mainboard Features 2-1
<i>Section 3</i>	<i>Installation</i>
	Mainboard Detailed Layout 3-2
	<i>Easy Installation Procedure</i>
	CPU Insertion 3-3
	Jumper Settings 3-5
	System Memory Configuration 3-6
	Device Connectors 3-8
	External Modem Ring-in Power ON and Keyboard Power ON Function (KBPO) 3-13
	STR (Suspend To RAM) Function 3-15
	“POSTMAN” Function Introduction 3-17
<i>Section 4</i>	<i>Award BIOS Setup</i>
	Main Menu 4-1
	Standard CMOS Setup 4-3
	Advanced BIOS Features 4-7

Advanced Chipset Features	4-10
Integrated Peripherals	4-14
Power Management Setup	4-19
PNP/PCI Configuration Setup	4-22
PC Health Status	4-23
Frequency Control	4-25
Defaults Menu	4-26
Supervisor/User Password Setting	4-27
Exit Selecting	4-28

Section 5 ***815 Series VGA and Sound Driver Installation***

Easy Driver Installation	5-1
--------------------------------	-----

Appendix

Appendix A

Load Optimized Defaults	A-1
-------------------------------	-----

Appendix B

GHOST 5.1 Quick User's Guide	B-1
------------------------------------	-----

Section 1
INTRODUCTION

Components Checklist

- ✓ A. (1) Mainboard
- ✓ B. (1) User's manual
- ✓ C. (1) Floppy ribbon cable
- ✓ D. (1) ATA66/100 Hard drive ribbon cable
- ✓ E. (1) RS-232 9-PIN ribbon cable
- ✓ F. (1) Onboard Graphic and Sound Driver
- G. (1) AIMM Card (optional)
- H. (1) TV out display adapter and cable (optional)
- I. (1) Digital display (DTFP) and cable (optional)

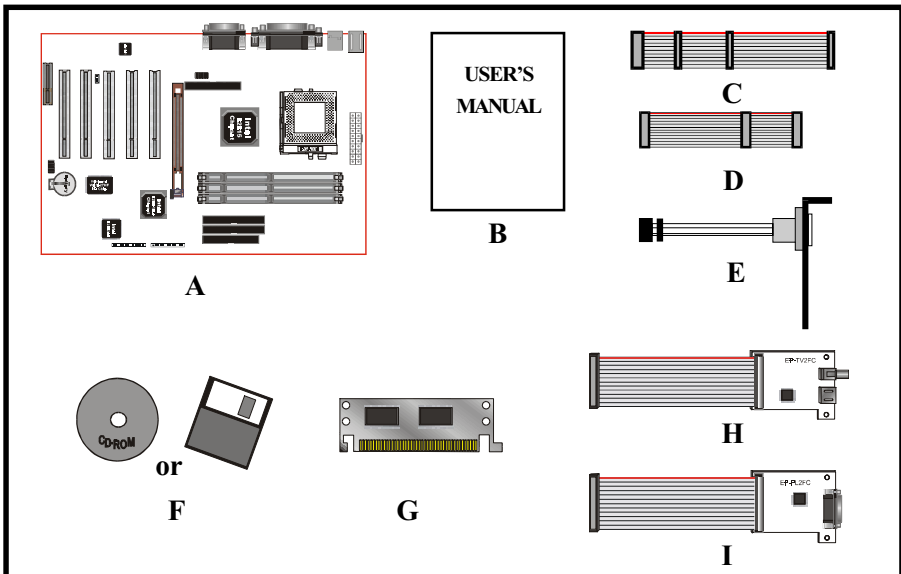

Intel Celeron processors (P.P.G.A.) 370

The Intel Celeron processors provide power to handle the internet, educational programs, interactive 3D games, and productivity applications. The Intel Celeron processors at 766, 733, 700, 667, 633, 600, 566, 533MHz include integrated L2 cache 128Kbyte. The core for the 766, 733, 700, 667, 633, 600, 566, 533MHz processors have 19M transistors due to the addition of the integrated L2 cache 128Kbyte. All the Intel Celeron processors are available in the plastic pin grid array (P.P.G.A.) form factor. The P.P.G.A. form factor is compatible with the 370 pin socket. All the Intel Celeron processors are available in the plastic pin grid array (PPGA) package. The PPGA package is compatible with the 370 pin socket and provides more flexibility to design low cost systems by enabling lower profile and smaller systems and providing the potential for reducing costs of processor retention and cooling solutions. Like the Intel Celeron processors that utilize S.E.P.P., the Intel Celeron processors that use P.P.G.A., feature a P6-microarchitecture-based core processor on a single-sided substrate without BSRAM componentry.

The Intel Celeron processor at 766, 733, 700, 667, 633, 600, 566, 533MHz. Includes Intel MMX[tm] media enhancement technology. Offers Dynamic Execution technology.

Includes a 32Kbyte (16Kbyte/16Kbyte) non-blocking, level-one cache that provides fast access to heavily used data. Intel Celeron processors at 766, 733, 700, 667, 633, 600, 566, 533MHz include integrated L2 cache 128Kbyte. All the Intel Celeron processor utilize the Intel P6 microarchitecture's multi-transaction system bus at 66MHz. The 766, 733, 700, 667, 633, 600, 566, 533MHz processors utilize the Intel P6 microarchitecture's multi-transaction system bus with the addition of the L2 cache interface. The combination of the L2 cache bus and the processor-to-main-memory system bus increases bandwidth and performance over single-bus processors.

Intel MMX technology includes new instructions and data types that allow applications to achieve a new level of performance. Intel's MMX technology is

designed as a set of basic, general-purpose integer instructions that are easily applied to the needs of a wide diversity of multimedia and communications applications. The highlights of the technology are:

- * Single Instruction, Multiple Data (SIMD) technique
- * 57 new instructions
- * Eight 64-bit wide MMX technology registers
- * Four new data types

Intel Coppermine processors (FC-PGA) 370

These Coppermine-128K and Coppermine-256K processor is the next addition to the P6 micro architecture product family. The FC-PGA package is a new addition to the Intel IA-32 processor line and hereafter will be referred to as the “Coppermine FC-PGA processor”, or simply “The processor”. The package utilizes the same 370-pin zero insertion force socket (PGA370) used by the Intel Celeron processor. Thermal solutions are attached directly to the back of the processor core package without the use of a thermal plate or heat spreader.

The Coppermine processor, like the Intel Celeron, Intel Pentium II and Pentium III in the P6 family processor, implement a Dynamic Execution micro architecture --- a unique combination of multiple branch prediction, data flow analysis, and speculative execution. This enable these processors to deliver higher performance than the Intel Pentium processor, while maintaining binary compatibility with all previous Intel Architecture processors. The processor also executes Intel MMX technology instructions for enhanced media and communication performance just as it’s predecessor the Intel Pentium III processor. Additionally the Coppermine FC-PGA processor executes streaming SIMD (Single-Instruction Multiple Data) Extensions for enhanced floating point and 3-D application performance. The concept of processor identification, via CPUID, is extended in the processor family with the addition of a processor serial number. The processor utilizes multiple low-power states such as AutoHALT, Stop-Grant, Sleep and Deep Sleep to conserve power during idle times.

The processor includes an integrated on-die, 128KB or 256KB, 8-way set associative level-two (L2) cache with a separated 16KB level one (L1) instruction cache

Introduction

and 16KB level one (L1) data cache. These cache arrays run at the full speed of the processor core. As with the Intel Pentium III processor, the Coppermine FC-PGA processor has a dedicated L2 cache bus, thus maintaining the dual independent bus architecture to deliver high bus bandwidth and performance. Memory is cacheable for 4GB/64GB of addressable memory space, allowing significant headroom for desktop system.

Intel(R) 815 Series chipset features

The Intel(R) 815 series chipset that SDRAM interface supports 100MHz and 133MHz operation, the Intel(R) 815 series chipset has re-engineered the Value PC, providing next generation features and great graphics performance.

The 82815 series Graphics Memory Controller Hub (GMCH) features : Intel(R) graphics technology and software drivers, using Direct AGP (integrated AGP) to create vivid 2D and 3D effects and images. The 82815 series chip feature integrated Hardware Motion Compensation to improve soft DVD video quality.

The Intel(R) 82815 series chipset use Intel(R) Dynamic Video Memory Technology (D.V.M.T.) is an architecture that offers breakthrough performance for the (motherboard) PC through efficient memory utilization and Direct AGP. The system OS uses the Intel software drivers and intelligent memory arbiter to support richer graphics applications.

The Intel(R) 82815 series provides an AGP universal connector to support the AGP 2.0 including 4X AGP data transfers.

The 82801BA I/O Controller Hub (ICH2) employs the Intel(R) Accelerated Hub Architecture to make a direct connection from the graphics and memory to the integrated AC97 controller, the IDE controllers (ATA/66 or ATA/33 or ATA/100), dual USB ports, and PCI add-in cards.

The Accelerated Hub Architecture provides twice the bandwidth of the PCI bus at 266 MB per second. This allows a wider flow of rich information from the I/O controller to the memory controller, with optimized arbitration rules allowing more functions to run concurrently, enabling more life-like audio and video.

The Integrated Audio-Codec 97 controller enables software audio by using the processor to run sound. By reusing existing system resources, this feature adds flexibility, improves sound and modem quality.

The 82802 Firmware Hub (FWH, 4MB) stores system BIOS and video BIOS, eliminating a redundant nonvolatile memory component. In addition, the 82802 contains a hardware Random Number Generator (RNG). The Intel(R) RNG provides truly random numbers to enable fundamental security building blocks supporting stronger encryption, digital signing, and security protocols for the future application program .

Introduction

Accelerated Graphics Port (AGP or A.G.P.)

Typically, 3D graphics rendering requires a tremendous amount of memory, and demands ever increasing throughput speed as well. As 3D products for the personal computer become more and more popular, these demands will only increase. This will cause a rise in costs for both end users and manufacturers. Lowering these costs as well as improving performance is the primary motivation behind AGP. By providing a massive increase in the bandwidth available between the video card and the processor, it will assist in relieving some of these pressures for quite sometime.

The board provides the AGP 2.0 interface. The AGP Interface Specification revision 2.0 enhances the functionality of the original AGP Interface Specification (revision 1.0) by allowing 4X data transfers (4 data samples per clock) and 1.5 volt (power supply) operation. The AGP 2.0 interface, along with Direct Rambus memory technology, allows graphics controllers to access main memory at over 1GB/s. In order to match the 1X, 2X and 4X AGP Card. The board used the Universal AGP connector. To maximize add-in flexibility. (such as 1.5 volt for 1X, 2X and 4X or 3.3 volt for 1X and 2X AGP Card).

Ultra ATA/66/100

The ICH2 provides two channel Ultra ATA/66/100 Bus Master IDE controller, that support Ultra ATA/66/100 protocols, perfect for such demanding applications as real-time video, multimedia, and high performance operating system. A new IDE cable is required for Ultra ATA/66/100. This cable is an 80 conductor cable; however the connectors are, of course, backwards compatible with ATA/33.

Hardware Monitoring

Hardware monitoring allows you to monitor various aspects of your systems operations and status. The features include CPU temperature, voltage and RPM of fan.

Mainboard Form-Factor

The board is designed with ATX form factor - the new industry standard of chassis. The ATX form factor is essentially a Baby-AT baseboard rotated 90 degrees within the chassis enclosure and a new mounting configuration for the power supply. With these changes the processor is relocated away from the expansion slots, allowing them all to hold full length add-in cards. ATX defines a double height aperture to the rear of the chassis which can be used to host a wide range of onboard I/O. Only the size and position of this aperture is defined, allowing PC manufacturers to add new I/O features (e.g.; TV input, TV output, modem, LAN, etc.) to systems. This will help systems integrators differentiate their products in the marketplace, and better meet your needs.

- Smaller size promotes a smaller system size.
- I/O shield does not need to be retooled in an ATX 2.01 or later. Mainboard could be used in an ATX 2.01-compliant.
- A smaller power supply can be used. High integration on mainboard reduces the system costs.

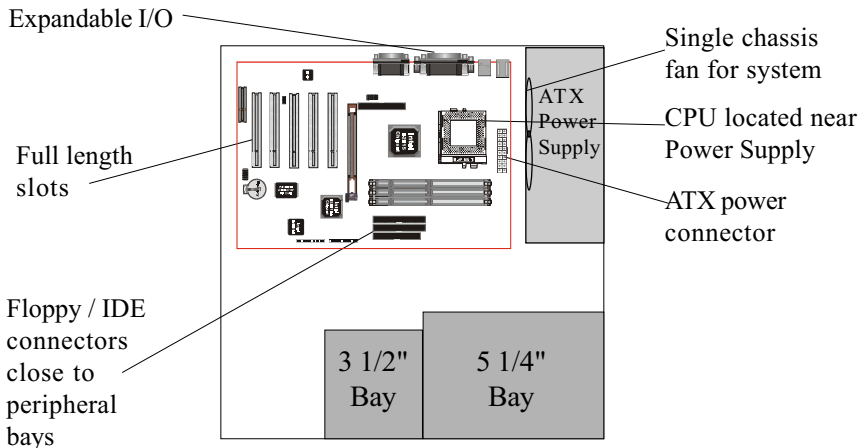

Figure 2: Summary of ATX chassis features

Introduction

I/O Shield Connector

The board is equipped with an I/O back panel. Please use the appropriate I/O shield (figure 3).

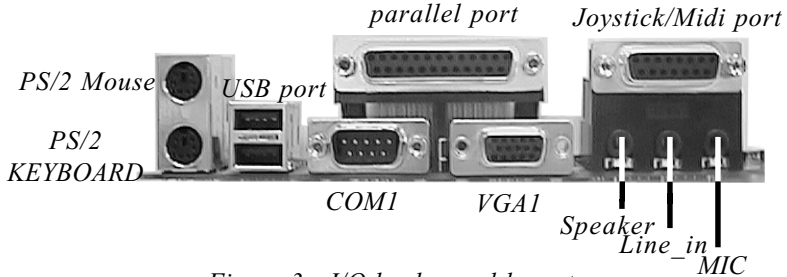
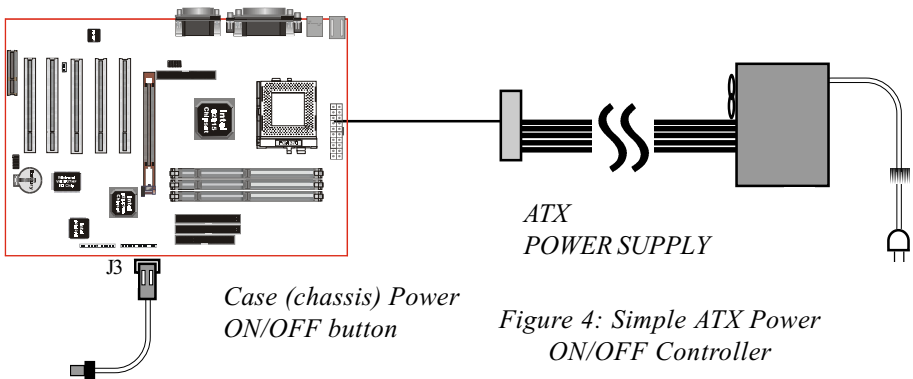

Figure 3: I/O back panel layout

Power-On/Off (Remote)

The board has a single 20-pin connector for ATX power supplies. For ATX power supplies that support the **Remote On/Off** feature, this should be connected to the systems front panel for system Power On/Off button. The systems power On/Off button should be a momentary button that is normally open.

The board has been designed with "Soft Off" functions. You can turn Off the system from one of two sources: The first is the front panel Power On/Off the button, and the other is the "Soft Off" function (coming from the M/B's onboard circuit controller) that can be controlled by the operating system such as Windows® 95/98 or Windows® 2000.



Case (chassis) Power ON/OFF button

Figure 4: Simple ATX Power ON/OFF Controller

System Block Diagram

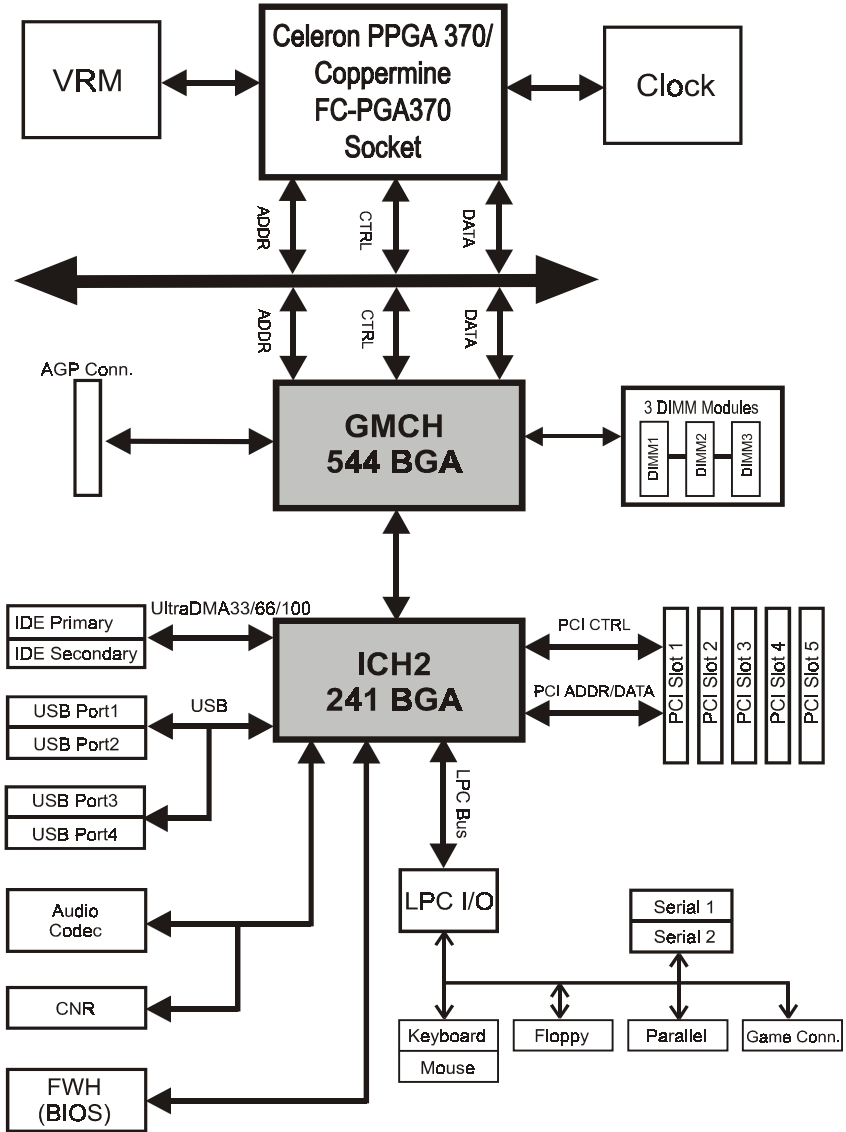

Figure 5: System Block Diagram

Mainboard Features:

- The board is based on the Socket 370 Processors including PPGA & FC-PGA operating at 433 ~933MHz. The board is configured by a BIOS setting to match your CPU clock speed.
- The board designed with Intel 815E chipset that provides optimized support for P.P.G.A Celeron of 66MHz and FC-PGA Coppermine of 100/133MHz Front Side Bus CPU.
- Supports AGP universal connector support via dual mode buffers to allow AGP 2.0 3.3V (2X AGP) or 1.5V (4X AGP) signaling.
- Supports the AGP signal interface with the integrated graphics display cache interface. The 4MB Display Cache (for integrated graphics) with AGP/Display Cache share interface (AGP In-Line Memory Module or A1MM Card).
- Supports up to 512 MB of DRAM (minimum of 32 MB) on board, You can use 168-pin DIMM x 3. It will run Synchronous DRAM memory (SDRAM) at 100MHz/133MHz.
- Integrated 2D & 3D Graphics Engine, H/W Motion Compensation Engine, 230MHz DAC and 4MB Display Cache.
- AC'97 2.1 Audio CODEC onboard for enables the software Audio.
- Supports (5) 32 bit PCI slots, provides (2) independent high performance PCI IDE interfaces capable of supporting PIO Mode 3/4 and Ultra DMA 66/100 devices. The board supports (5) PCI Bus Master slots and a jumperless PCI INT# control scheme which reduces configuration confusion when plugging in PCI card(s).
- Supports ATAPI (e.g. CD-ROM) devices on both Primary and Secondary IDE interfaces.

Features

- Designed with Winbond W83627HF LPC (Low Pin Count) I/O: (1) floppy port, (1) parallel port (EPP, ECP), (2) serial ports (16550 Fast UART), IrDA version SIR protocol or SHARP ASK-IR protocol, (1) Game port and MIDI port.
- Includes PS/2 mouse and keyboard connectors.
- Features Award Plug & Play BIOS. With 4MB(FWH) Flash Memory you can always upgrade to the current BIOS.
- Utilizes a Lithium battery which provides environmental protection and longer battery life.
- The onboard ICH2(82801BA) chip provides the means for connecting PC Interface and peripherals such as; PCI Bus I/F, LPC I/F, SM Bus, IDE and USB.
- Supports up to 4 USB ports, two on the back panel and two for front or USB cable (optional), for more peripheral connectivity options.
- Built-in ATX 20-pin power supply connector.
- Software power-down when using Windows® 95/98 or Windows® 2000.
- Supports ring-in feature (remote power-on through external modem, allow system to be turned on remotely).
- Resume by Alarm - Allow your system to turn on according to setup schedule in the BIOS.
- Supports CPU & Hardware sleep and SMM (System Management Mode).
- Supports Hot key, Any key or password Keyboard power ON function (KBPO).
- Supports the CPU, Power and Chassis fan Auto stop in the sleep mode.
- Supports the System Power LED (PANEL) blinks in the sleep mode.
- Built-in WOL (Wake On Lan) Connector.
- Y2K Compliant.
- Advanced Configuration Power Interface (ACPI) ready.

- Supports USDM software to offer motherboard various status on Windows® 95/98.
- Supports the STR (Suspend To RAM) power management by ACPI's S3 (Optional).
- Supports the STR indicator red LED (D5) to avoid plugging or un-plugging DIMM modules when in a STR mode or power on mode (Optional).
- Supports a CNR Connector for V9.0 analog modem, phone-line base and 10/100 Ethernet base networking.
- Supports TV-Out and Flat Panel Connector (optional), provides EP-TV2FC, EP-PL2FC Card. You can use TV or LCD Monitor or CRT Monitor for best choice.
- Supports a "POSTMAN" function to deliver a easy way for the Power On Self Test (POST) sending out a error messages via huMANlike voice .

Section 3
INSTALLATION

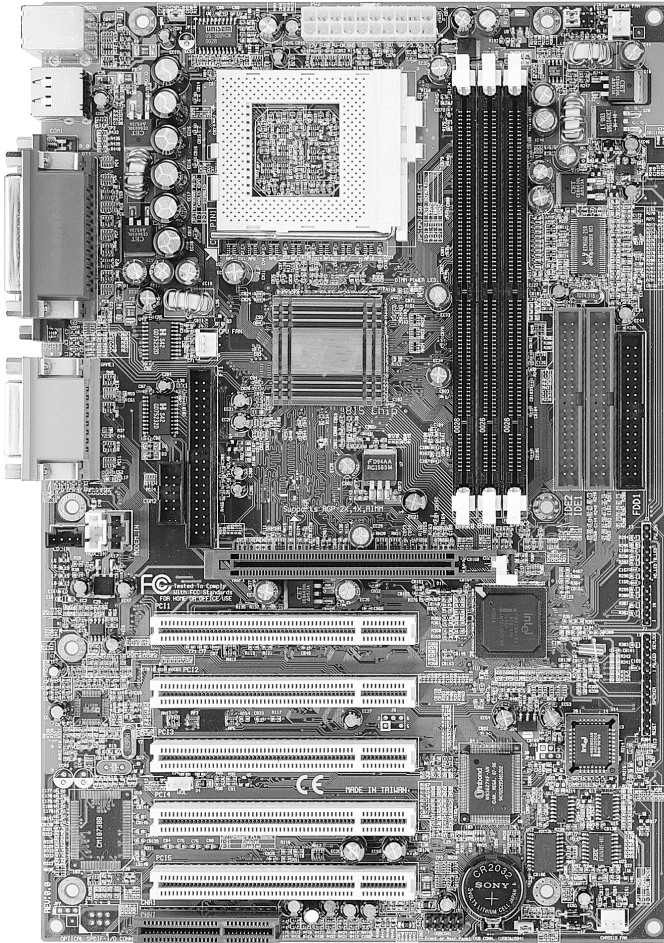

Mainboard Detailed Layout

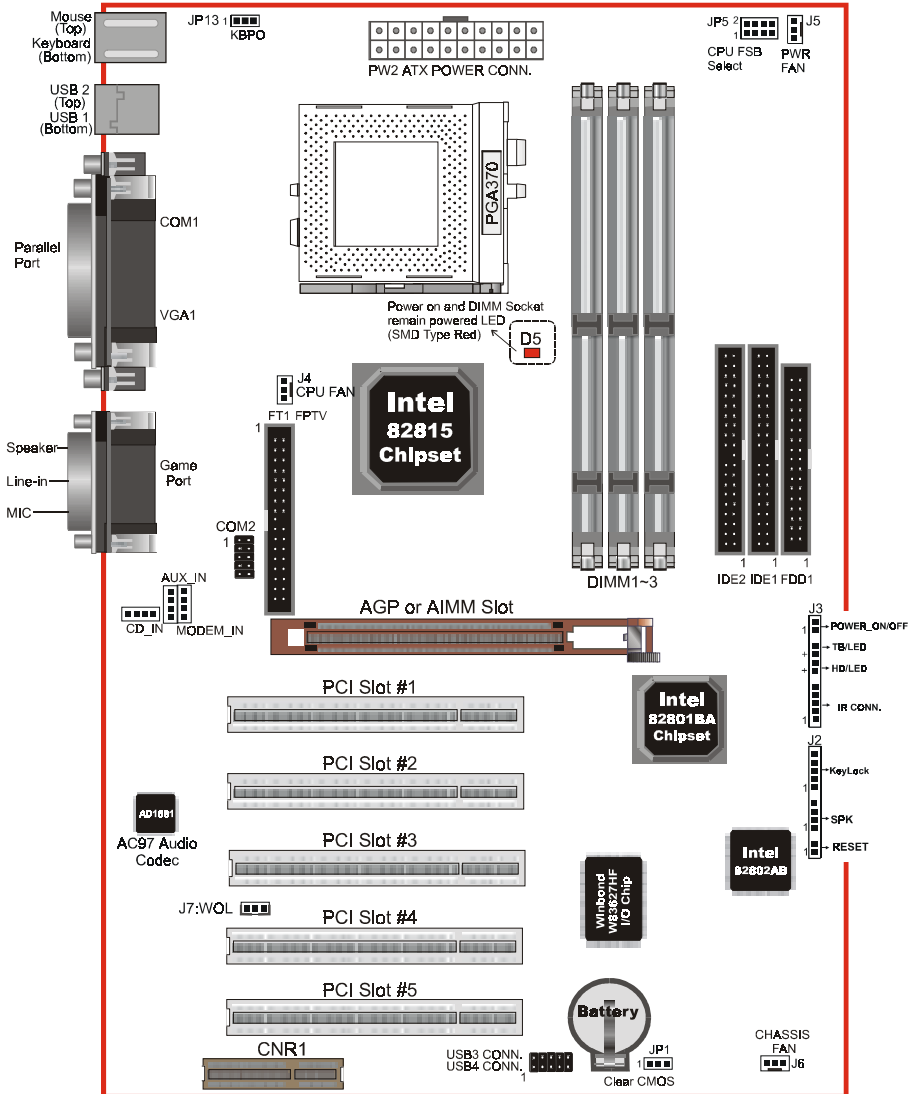

Figure 1

Easy Installation Procedure

The following must be completed before powering on your new system:

- 3-1. **CPU Insertion**
- 3-2. **Jumper Settings**
- 3-3. **System memory Configuration**
- 3-4. **Device Connectors**
- 3-5. **External Modem Ring-in Power ON and Keyboard Power ON Functions (KBPO)**
- 3-6. **STR (Suspend To RAM) Function**

Section 3-1 CPU Insertion

CPU Insertion

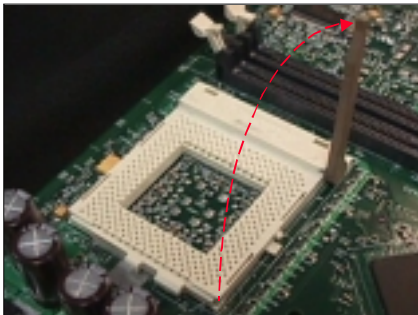

Figure 2

Step 1

Open the socket by raising the actuation lever.

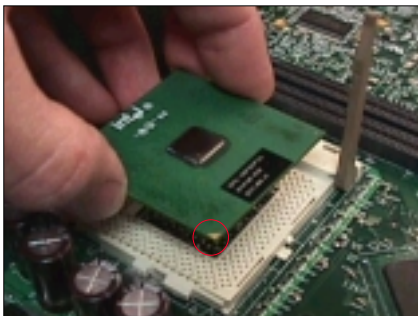

Figure 3

Step 2

Insert the processor.

Ensure proper pin 1 orientation by aligning the FC-PGA corner marking with the socket corner closest to the actuation arm tip. The pin field is keyed to prevent mis-oriented insertion. Don't force processor into socket. If it does not go in easily, check for mis-orientation and debris.

Make sure the processor is fully inserted into the socket on all sides.

Installation



Step 3

Close the socket by lowering and locking the actuation lever.

Figure 4

Note: Intel's reference design thermal solution is an active heatsink; an extruded aluminum heatsink based and a fan attached to the top on the fin array. (See Figure 5)



Figure 5

Section 3-2
Jumper Settings

JP1



CMOS Clear

JP1 = 1-2 Normal (Default)
= 2-3 Clear CMOS

JP5

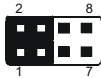

CPU FSB Select

JP5		CPU FSB Select
1-3	2-4	AUTO (Default)
3-5	4-6	133MHz
5-7	4-6	100MHz
5-7	6-8	66MHz

JP13



Keyboard Power-ON Function

JP13 = 1-2 Enabled
= 2-3 Disabled (Default)

Installation

Section 3-3 System Memory Configuration

Memory Layout

The board supports (3) 168-pin DIMMs (Dual In-line Memory Module). The DIMMs is for SDRAM (Synchronized DRAM).

- FSB 66/100MHz for 100MHz SDRAM interface only, FSB 133MHz for 100/133MHz SDRAM interface.
- 32MB to 256MB using 64MB technology (512MB using 128MB technology), maximum 512MB on 3 DIMM sockets.
- No Registered SDRAM Memory Modules Support.
- Double Side Unbuffered Memory Module without ECC supports.
- We recommend using at least 125MHz (-8ns) SDRAM at the 100MHz (or higher) FSB as timing becomes more critical at these higher speeds.
- DIMM SDRAM may be 100MHz (-10ns) or 133MHz (-7.5ns) bus speed.

Figure 6 and Table 1 show several possible memory configurations.

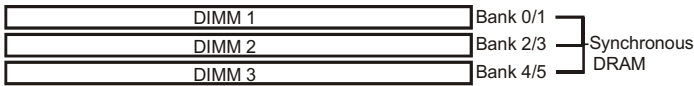

Figure 6

Total Memory	DIMM 1 (Bank 0/1)	DIMM 2 (Bank 2/3)	DIMM 3 (Bank 4/5)
= 256MB Maximum	SDRAM* 32MB, 64MB, 128MB, 256MB X 1	None	
= 512MB Maximum	SDRAM* 32MB, 64MB, 128MB, 256MB X 1	SDRAM* 32MB, 64MB, 128MB, 256MB X 1	None
= 512MB Maximum	SDRAM* 32MB, 64MB, 128MB, 256MB X 1	SDRAM* 32MB, 64MB, 128MB X1	SDRAM* 32MB, 64MB, 128MB X1

Table 1

- * SDRAM supports 32, 64, 128, 256MB DIMM modules.
- * We recommend to use PC100 Memory Module for bus speed (FSB) between 66MHz/100MHz and PC133 Memory for bus speed (FSB) at 133MHz.
- * Using non-compliant memory with higher bus speed (over clocking) may severely compromise the integrity of the system.

DIMM Module Installation

Figure 7 displays the notch marks and what they should look like on your DIMM memory module.

DIMMs have 168-pins and two notches that will match with the onboard DIMM socket. DIMM modules are installed by placing the chip firmly into the socket at a 90 degree angle and pressing straight down (figure 8) until it fits tightly into the DIMM socket (figure 9).

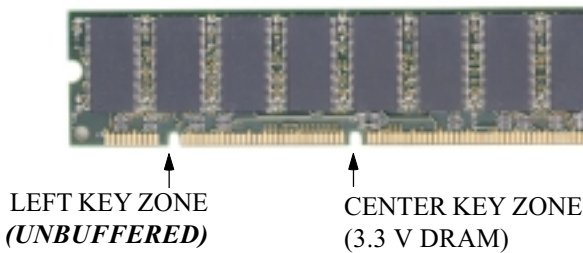
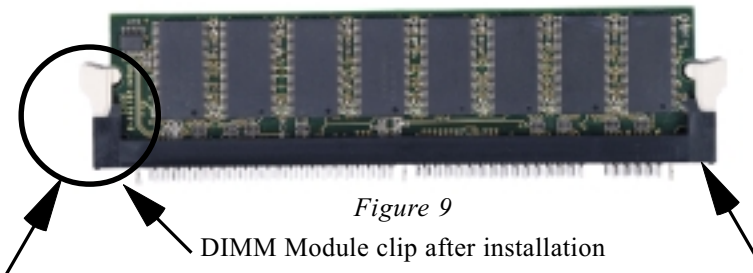
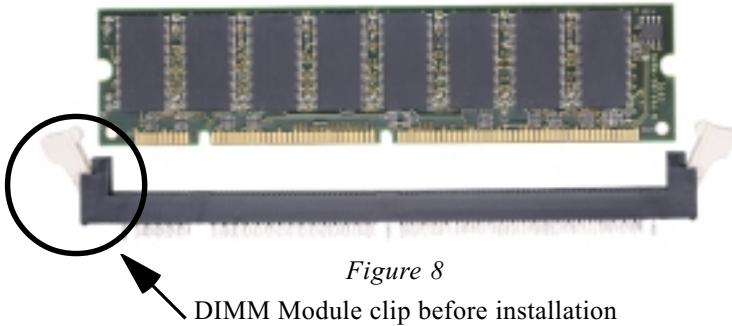

Figure 7



To remove the DIMM module simply press down both of the white clips on either side and the module will be released from the socket.

Installation

Section 3-4 Device Connectors

Please install the motherboard into the chassis.

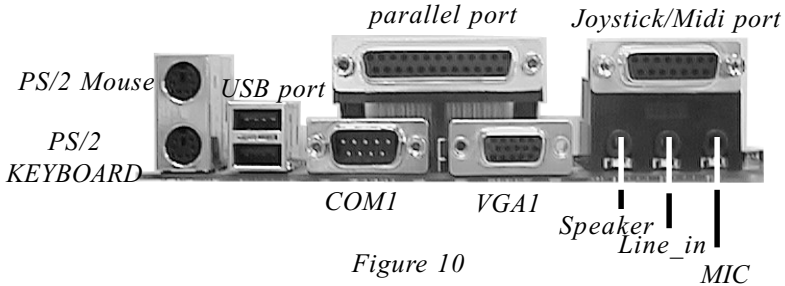

J2,J3: Chassis Panel Connector

- Keylock, Speaker, Reset, Power On/Off, Turbo LED, HDD LED and IR

J4: CPU Fan Power

- A plug-in for the CPU Fan Power

J5: Power Fan Power

- A plug-in for the Power Fan Power

J6: Chassis Fan Power

- A plug-in for the chassis Fan Power

J7: WOL (Wake On Lan) Connector

COM2: RS232 COM2 Connector

PW2: ATX Power Connector

- 20-pin power connector

IDE1: Ultra ATA66/100 Primary IDE Connector (Blue color)

IDE2: Ultra ATA66/100 Secondary IDE Connector (Blue color)

FDD1: Floppy Controller Connector (Black color)

CD_IN: CD Audio_IN Connector

- Pin1(CD_IN_Left), Pin2/Pin3(CD_Reference), Pin4(CD_IN_Right)

AUX_IN: Auxiliary Line_IN Connector

- Pin1(Left Line_IN), Pin2/Pin3(GND), Pin4(Right Line-IN)

MODEM_IN: Telephony Connector

- Pin1(Audio_in), Pin2/Pin3(GND), Pin4(Mic-out to Modem)

USB Conn.: USB3 and USB4 Connector for optional cable.

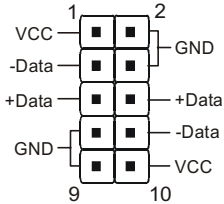

USB port header pin descriptions.

PIN#	Wire color	Signal Name	Comment
1	Red	Vcc	Cable Power
2	Black	Ground	Case Ground
3	White	-Data	Data
4	Black	Ground	Cable Ground
5	Green	+Data	Data
6	Green	+Data	Data
7	Black	Ground	Cable Ground
8	White	-Data	Data
9	Black	Ground	Case Ground
10	Red	Vcc	Cable Power

Installation

Device Connectors (continued)

Power On/Off

(This is connected to the power button on the case. Using the Soft-Off by Pwr-BTTN feature, you can choose either Instant Off (turns system off immediately), or 4 sec delay (you need to hold the button down for 4 seconds before the system turns off). When the system is in 4 sec delay mode, there is a special feature to make the system to go into suspend mode when the button is pressed momentarily.)

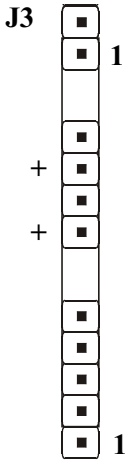

Turbo LED indicator - LED ON when higher speed is selected

IDE LED indicator - LED ON when Onboard PCI IDE Hard disks is activate

IR Connector

- | | |
|---------|---------|
| 1. VCC | 4. GND |
| 2. NC | 5. IRTX |
| 3. IRRX | |

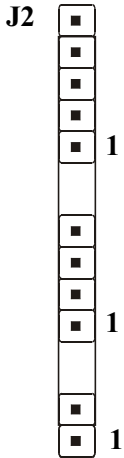

KeyLock - Keyboard lock switch & Power LED connector

- | | |
|-----------------|------------|
| 1. Power LED(+) | 4. KeyLock |
| 2. N/C | 5. GND |
| 3. GND | |

* The power LED lights when the system is powered on and blinks in SLEEP MODE or STR Mode.

Speaker - Connect to the system's speaker for beeping

- | | |
|------------|--------|
| 1. Speaker | 3. GND |
| 2. N/C | 4. GND |

Reset - Closed to restart system.

Device Connectors (continued)

- ◆ AIMM Card with AGP connector (For integrated graphics to upgrade 4MB display cache).

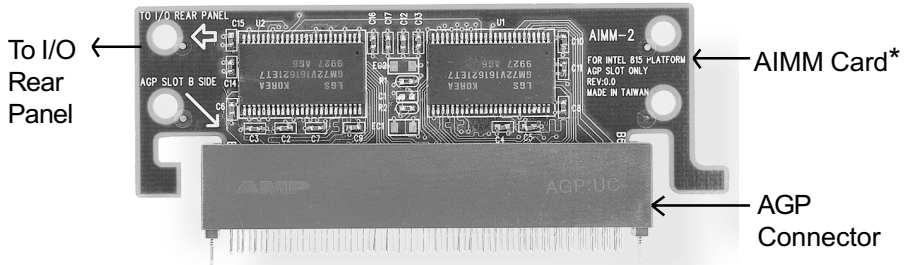

Note: The AIMM card for Intel 815 chipset M.B's AGP slot only.

* : The AIMM Card (optional)

- ◆ The board supports one CNR connector to provide a Modem Code (MC) or Phone-line base networking and 10/100 Ethernet base networking configuration.

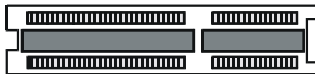

CNR Connector

Installation

Device Connectors (continued)

- ◆ TV2FC-PL2FC Connector (Digital Video Out interface for TV Out or digital display).

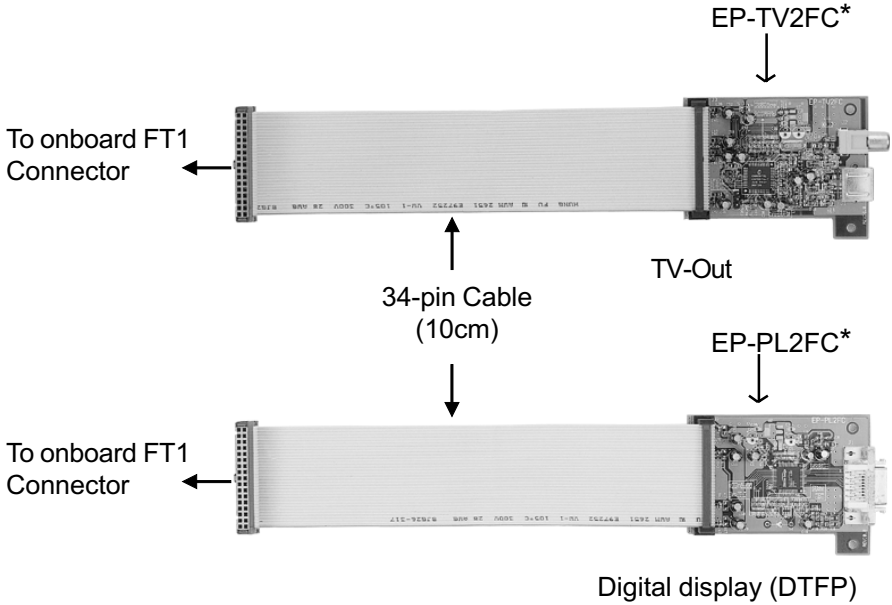

* The EP-TV2FC and EP-PL2FC adapter card (optional)

Section 3-5 External Modem Ring-in Power ON and Keyboard Power ON Functions (KBPO)

On the basis of bounded functions in I/O chipset, the two serial ports are able to support the External Modem Ring-in Power ON function. Once users connect the external modem to COM1 or COM2, the mainboard allows users to turn on their system through the remote and host's dial-up control.

Exclusive Keyboard Power ON Function

To innovate a unique feature to benefit users, we devoted the easiest and most convenient way to turn on your system based on the the ATX power supply.

How to work with it

Step 1: Please check JP13 at the position 1-2 after you finished the system installation.

JP13



Keyboard Power-ON Function Selection

1-2 : Enabled

2-3 : Disabled (Default)

Step 2: Push the momentary switch (J3 PW-ON) to turn on your system and then push again to hold for more than 4 seconds to turn it off after counting memory as soon as you turn it on.

Step 3: You can enjoy the Keyboard Power ON function (KBPO) by *pressing any 1 key, Hot key (Ctrl-F1, F2.....F12), Password (A maximum of 5 characters can be entered.) and BUTTON only to turn on your system. Please refer to the BIOS Integrated peripherals setup for detail. The BIOS Default is keyboard Hot key <Ctrl> - <F1> to turn on the system. Your system will be turned on automatically, after releasing the keys. To power off you system, you can use the Soft-OFF function under Windows 95.*

Installation

Notes:

1. Intel ATX version 2.0 specification has recommended you use the power supply with $\geq 1.0A$ in 5.0VSB. With our mainboard, *the 5.0VSB standby power only has to be $\geq 0.1A$ (100mA)* then you can enjoy this unique benefit. However, the ATX power supply which is < 0.1 (100mA) is still applicable to your system by placed JP13 at the position 2-3 to disable this feature.
2. We recommended you use the power supply with 1.0A in 5.0VSB. Because this supported PCI 2.1 specification for remote power-on and wake-up function.

3-6 STR (Suspend To RAM) Function (Optional)

The board supports the STR power management state by maintaining the appropriate states on the SDRAM interface signals. The power source must be kept alive to the SDRAM during STR (ACPI S3). Advanced Configuration Power Interface (ACPI) provides more Energy Saving Features for operating systems that supporting Instant ON and QuickStart™ function.

1. To enable the ACPI function and use the STR functionally to save your system energy, you are recommended to confirm the following requirements:
 - a. Please do install all ACPI qualified add-on cards such as AGP, LAN, Modem cards.
 - b. In BIOS, please select “ACPI function: Enable” and “ACPI Suspend Type: S3(STR)” in the Power Management Setup menu.
 - c. Then, please install the Windows® 98SE or Windows® 2000.
 - d. Restart your system.
 - e. Getting in to the “Advanced” of the Power Management icon of Control Panel, and selecting the “Stand By” in the Power Buttons.
2. Getting start with STR function, please click the START button and choose Shut Down. Then, select the Stand By option in the Shut Down Windows box to get into STR mode.

Here are the differences between STR power saving mode and Green (or Suspend) mode:

- a. It is the most advanced Power Management mode
- b. It cuts all the power supplied to peripherals except to Memory - max. power saving
- c. It saves and keeps all on-screen data including any executed applications to SDRAM.
- d. You must push the Power button connected with onboard J3 pin to wake up you system (not to click to mouse or press keyboard to wake up the system).

Installation

Just pushing Power button, your system will quickly back to the last screen for you.

The “LED Indicator for ACPI Status” table shown below will guide you and give you a reference for ACPI status on this mainboard.

ACPI Onboard's LED Status Indicator Table					
Onboard's LED Location	Status				
	Plug in the ATX Power Core	Power ON J3(PW-ON)	Green Mode (S1)	STR (S3)	Shutdown (Soft-OFF) (S5)
D5 (Red LED)	OFF	ON	ON	ON	OFF
J2 PW_LED	OFF	ON	Blinking	Blinking	OFF

3-7 “POSTMAN” Function Introduction

With the board also make our initial premier of the new “**POSTMAN**” debug function. This new feature designed to enhance the Power On Self Test (POST) introduces a huMANlike voice with helpful debugging/error messages. So in the event the system experiences boot up difficulties “POSTMAN” will deliver the message in an easier to understand method than traditional POSTcodes. Such as, “SDRAM Detect Fail” for memory missing, memory install improperly or memory broken and “VGA Fail” for AGP card missing, AGP card install improperly or AGP card broken.

The voice could be pronounced through either an internal speaker or external speakers plugged into Line Out connector for a clear sound.

The messages recorded for this function are listed below for your reference while having problems with system boot up.

0. SDRAM Detect Fail
1. BIOS ROM Checksum Fail
2. Keyboard or PS/2 Mouse Fail
3. VGA Fail
4. Clock Generator or Overclock Fail
5. NO CPU Fan
6. Over Voltage Fail
7. SMBUS Fail
8. System boot OK
9. CPU, BIOS or Power Cable plug in abnormal

Section 4

BIOS SETUP

Main Menu

Once you enter the AwardBIOS™ CMOS Setup Utility, the Main Menu will appear on the screen. The Main Menu allows you to select from several setup functions and two exit choices. Use the arrow keys to select among the items and press <Enter> to accept and enter the sub-menu.

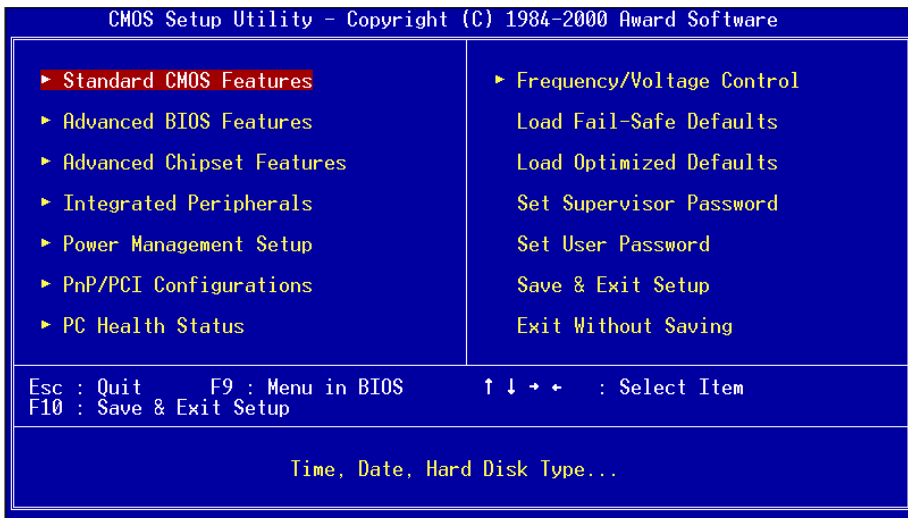

Note that a brief description of each highlighted selection appears at the bottom of the screen.

Setup Items

The main menu includes the following main setup categories. Recall that some systems may not include all entries.

Standard CMOS Features

Use this menu for basic system configuration.

BIOS

Advanced BIOS Features

Use this menu to set the Advanced Features available on your system.

Advanced Chipset Features

Use this menu to change the values in the chipset registers and optimize your system's performance.

Integrated Peripherals

Use this menu to specify your settings for integrated peripherals.

Power Management Setup

Use this menu to specify your settings for power management.

PnP / PCI Configuration

This entry appears if your system supports PnP / PCI.

PC Health Status

This item is only show the system health status (include Voltage, Fan speed, CPU temperature...)

Frequency/Voltage Control

Use this menu to specify your settings for frequency/voltage control.

Load Fail-Safe Defaults

Use this menu to load the BIOS default values for the minimal/stable performance for your system to operate.

Load Optimized Defaults

Use this menu to load the BIOS default values that are factory settings for optimal performance system operations. While Award has designed the custom BIOS to maximize performance, the factory has the right to change these defaults to meet their needs.

Supervisor / User Password

Use this menu to set User and Supervisor Passwords.

Save & Exit Setup

Save CMOS value changes to CMOS and exit setup.

Exit Without Save

Abandon all CMOS value changes and exit setup.

4-1 Standard CMOS Setup

The items in Standard CMOS Setup Menu are divided into 10 categories. Each category includes no, one or more than one setup items. Use the arrow keys to highlight the item and then use the <PgUp> or <PgDn> keys to select the value you want in each item.

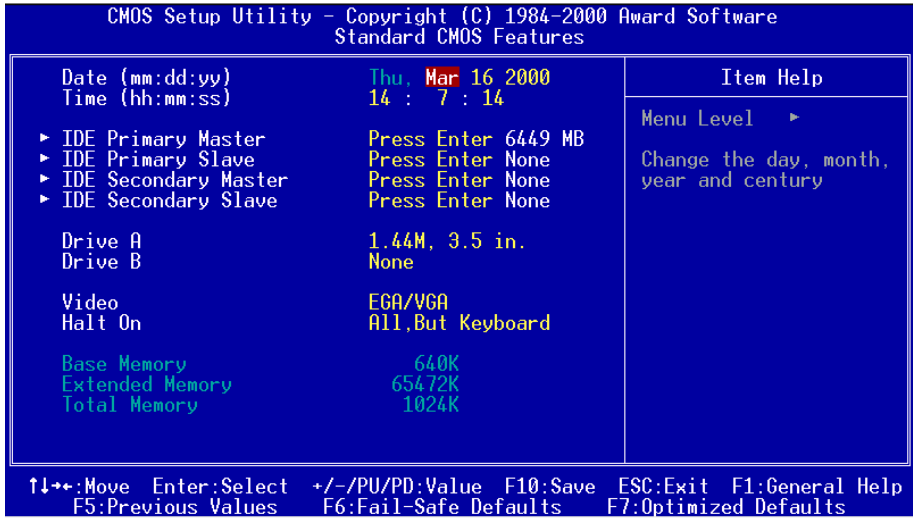

Figure 1: The Main Menu

Main Menu Selections

This table shows the selections that you can make on the Main Menu

Item	Options	Description
Date	Month DD YYYY	Set the system date. Note that the 'Day' automatically changes when you set the date
Time	HH : MM : SS	Set the system time
IDE Primary Master	Options are in its sub menu (described in Table 3)	Press <Enter> to enter the sub menu of detailed options
IDE Primary Slave	Options are in its sub menu (described in Table 3)	Press <Enter> to enter the sub menu of detailed options
IDE Secondary Master	Options are in its sub menu (described in Table 3)	Press <Enter> to enter the sub menu of detailed options
IDE Secondary Slave	Options are in its sub menu (described in Table 3)	Press <Enter> to enter the sub menu of detailed options
Drive A Drive B	None 360K, 5.25 in 1.2M, 5.25 in 720K, 3.5 in 1.44M, 3.5 in 2.88M, 3.5 in	Select the type of floppy disk drive installed in your system
Video	EGA/VGA CGA 40 CGA 80 MONO	Select the default video device
Halt On	All Errors No Errors All, but Keyboard All, but Diskette All, but Disk/Key	Select the situation in which you want the BIOS to stop the POST process and notify you
Base Memory	N/A	Displays the amount of conventional memory detected during boot up
Extended Memory	N/A	Displays the amount of extended memory detected during boot up
Total Memory	N/A	Displays the total memory available in the system

Table 2 Main Menu Selections

IDE Adapters

The IDE adapters control the hard disk drive. Use a separate sub menu to configure each hard disk drive.

Figure 2 shows the IDE primary master sub menu.

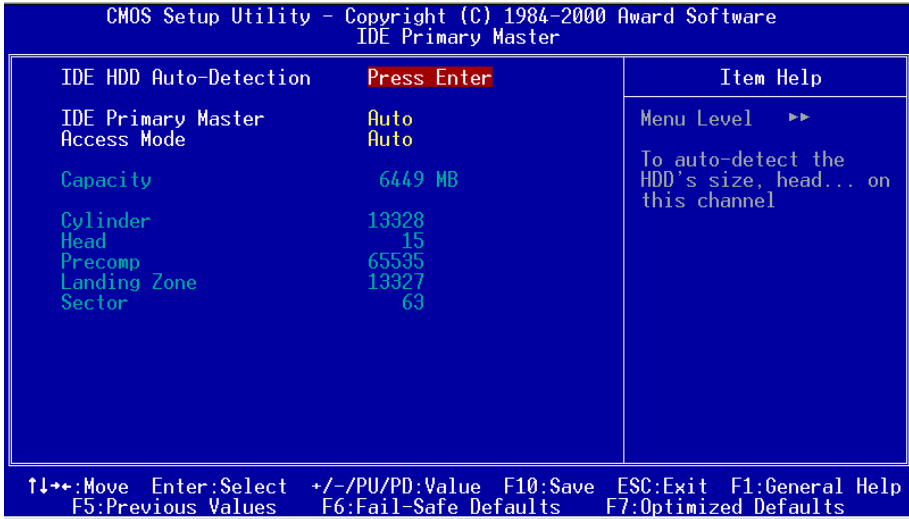

Figure 2 IDE Primary Master sub menu

BIOS

Use the legend keys to navigate through this menu and exit to the main menu. Use Table 3 to configure the hard disk.

<i>Item</i>	<i>Options</i>	<i>Description</i>
IIDE HDD Auto-detection	Press Enter	Press Enter to auto-detect the HDD on this channel. If detection is successful, it fills the remaining fields on this menu.
IDE Primary Master	None Auto Manual	Selecting 'manual' lets you set the remaining fields on this screen. Selects the type of fixed disk. "User Type" will let you select the number of cylinders, heads, etc. Note: PRECOMP=65535 means NONE !
Capacity	Auto Display your disk drive size	Disk drive capacity (Approximated). Note that this size is usually slightly greater than the size of a formatted disk given by a disk checking program.
Access Mode	Normal LBA Large Auto	Choose the access mode for this hard disk
The following options are selectable only if the 'IDE Primary Master' item is set to 'Manual'		
Cylinder	Min = 0 Max = 65535	Set the number of cylinders for this hard disk.
Head	Min = 0 Max = 255	Set the number of read/write heads
Precomp	Min = 0 Max = 65535	**** Warning: Setting a value of 65535 means no hard disk
Landing zone	Min = 0 Max = 65535	****
Sector	Min = 0 Max = 255	Number of sectors per track

Table 3 Hard disk selections

4-2 Advanced BIOS Features

This section allows you to configure your system for basic operation. You have the opportunity to select the system’s default speed, boot-up sequence, keyboard operation, shadowing and security.

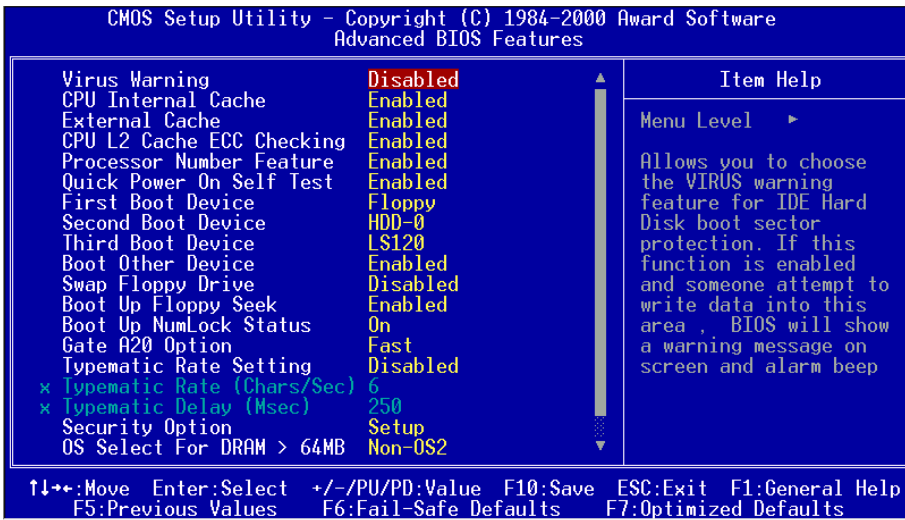

Virus Warning

Allows you to choose the VIRUS Warning feature for IDE Hard Disk boot sector protection. If this function is enabled and someone attempt to write data into this area, BIOS will show a warning message on screen and alarm beep.

Enabled: Activates automatically when the system boots up causing a warning message to appear when anything attempts to access the boot sector or hard disk partition table.

Disabled: No warning message will appear when anything attempts to access the boot sector or hard disk partition table.

CPU Internal Cache/External Cache

These two categories speed up memory access. However, it depends on CPU/chipset design.

Enabled: Enable cache

Disabled: Disable cache

BIOS

CPU L2 Cache ECC Checking

This item allows you to enable/disable CPU L2 Cache ECC checking.

The choice: Enabled, Disabled.

Processor Number Feature

Pentium III or later CPU new feature. The default is Enabled.

Enabled: Processor serial number readable.

Disabled: Processor serial number disabled.

Quick Power On Self Test

This category speeds up Power On Self Test (POST) after you power up the computer. If it is set to Enable, BIOS will shorten or skip some check items during POST.

Enabled: Enable quick POST

Disabled: Normal POST

First/Second/Third/Other Boot Device

The BIOS attempts to load the operating system from the devices in the sequence selected in these items.

The Choice: Floppy, LS120, HDD, SCSI, CDROM, Disabled.

Swap Floppy Drive

If the system has two floppy drives, you can swap the logical drive name assignments.

The choice: Enabled/Disabled.

Boot Up Floppy Seek

Seeks disk drives during boot up. Disabling speeds boot up.

The choice: Enabled/Disabled.

Boot Up NumLock Status

Select power on state for NumLock.

The choice: On/Off.

Gate A20 Option

Select if chipset or keyboard controller should control GateA20.

Normal: A pin in the keyboard controller controls GateA20

Fast: Lets chipset control GateA20

Typematic Rate Setting

Key strokes repeat at a rate determined by the keyboard controller. When enabled, the typematic rate and typematic delay can be selected.

The choice: Enabled/Disabled.

Typematic Rate (Chars/Sec)

Sets the number of times a second to repeat a key stroke when you hold the key down.

The choice: 6, 8, 10, 12, 15, 20, 24, 30.

Typematic Delay (Msec)

Sets the delay time after the key is held down before it begins to repeat the keystroke.

The choice: 250, 500, 750, 1000.

Security Option

Select whether the password is required every time the system boots or only when you enter setup.

System The system will not boot and access to Setup will be denied if the correct password is not entered at the prompt.

Setup The system will boot, but access to Setup will be denied if the correct password is not entered at the prompt.

Note: To disable security, select PASSWORD SETTING at Main Menu and then you will be asked to enter password. Do not type anything and just press <Enter>, it will disable security. Once the security is disabled, the system will boot and you can enter Setup freely.

OS Select For DRAM > 64MB

Select the operating system that is running with greater than 64MB of RAM on the system. The choice: Non-OS2, OS2.

HDD S.M.A.R.T Capability

The choice: Enabled/Disabled.

Report No FDD For Win 95

Whether report no FDD for Win 95 or not.

The choice: Yes, No.

4-3 Advanced Chipset Features

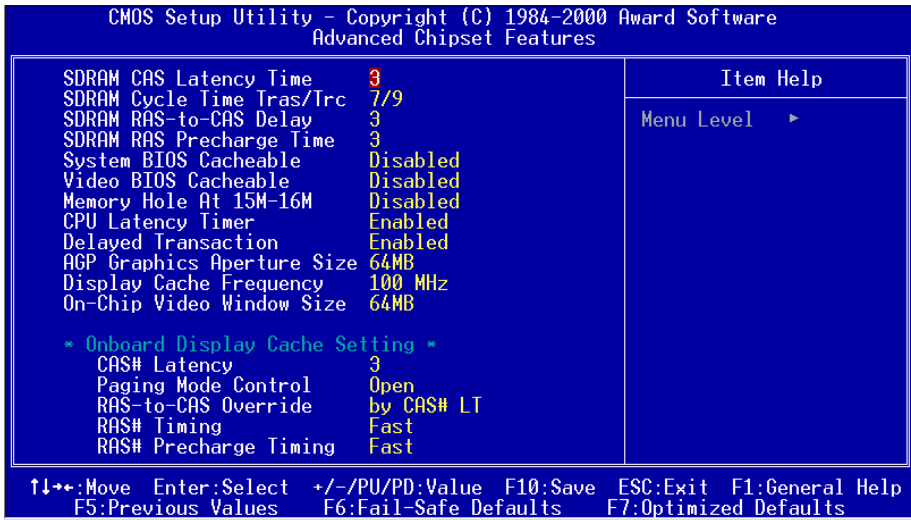

This section allows you to configure the system based on the specific features of the installed chipset. This chipset manages bus speeds and access to system memory resources, such as DRAM and the external cache. It also coordinates communications between the conventional ISA bus and the PCI bus. It must be stated that these items should never need to be altered. The default settings have been chosen because they provide the best operating conditions for your system. The only time you might consider making any changes would be if you discovered that data was being lost while using your system.

DRAM Settings (This field is no function)

The first chipset settings deal with CPU access to dynamic random access memory (DRAM). The default timings have been carefully chosen and should only be altered if data is being lost. Such a scenario might well occur if your system had mixed speed DRAM chips installed so that greater delays may be required to preserve the integrity of the data held in the slower memory chips.

SDRAM CAS Latency Time

When synchronous DRAM is installed, the number of clock cycles of CAS latency depends on the DRAM timing.

The Choice: 2, 3

SDRAM Cycle Time Tras/Trc

Select the number of SCLKs for an access cycle.

The Choice: 5/7, 7/9.

SDRAM RAS-to-CAS Delay

This field lets you insert a timing delay between the CAS and RAS strobe signals, used when DRAM is written to, read from, or refreshed. *Fast* gives faster performance; and *Slow* gives more stable performance. This field applies only when synchronous DRAM is installed in the system.

The Choice: 2, 3.

SDRAM RAS Precharge Time

If an insufficient number of cycles is allowed for the RAS to accumulate its charge before DRAM refresh, the refresh may be incomplete and the DRAM may fail to retain data. *Fast* gives faster performance; and *Slow* gives more stable performance. This field applies only when synchronous DRAM is installed in the system.

The Choice: 2, 3.

System BIOS Cacheable

Selecting *Enabled* allows caching of the system BIOS ROM at F0000h-FFFFFh, resulting in better system performance. However, if any program writes to this memory area, a system error may result.

The choice: Enabled, Disabled.

Video BIOS Cacheable

Select *Enabled* allows caching of the video BIOS, resulting in better system performance. However, if any program writes to this memory area, a system error may result.

The Choice: Enabled, Disabled.

Memory Hole At 15M-16M

You can reserve this area of system memory for ISA adapter ROM. When this area is reserved, it cannot be cached. The user information of peripherals that need to use this area of system memory usually discusses their memory requirements.

The Choice: Enabled, Disabled.

BIOS

CPU Latency Timer

Enabled: The processor cycle will be deferred immediately after the GMCH receives another ADS#.

Disabled: The processor cycle will only be deferred after for 31 clocks and another ADS# has arrived.

Delayed Transaction

The chipset has an embedded 32-bit posted write buffer to support delay transactions cycles. Select *Enabled* to support compliance with PCI specification version 2.1.

The Choice: Enabled, Disabled.

AGP Graphics Aperture Size (MB)

The amount of system memory that the AGP card is allowed to share. The default is 64.

32: 32MB of systems memory accessible by the AGP card.

64: 64MB of systems memory accessible by the AGP card.

Display Cache Frequency

If your insert AGP In-Line Memory Module (AIMM). This function setting AIMM frequency. The default is 100MHz.

On-Chip Video Window Size

The amount of system memory that the 815 series AGP is allowed to share. The default is 64.

32: 32MB of systems memory accessible by the 815 series AGP.

64: 64MB of systems memory accessible by the 815 series AGP.

Onboard Display Cache Setting

Setting the onboard display cache timing.

CAS # Latency

Select the local memory clock periods.

The Choice: 2, 3

Paging Mode Control

Select the paging mode control.

The Choice: Close, Open.

RAS-to-CAS Override

Select the display cache clock periods control.

The Choice: by CAS# LT, Override(2).

RAS# Timing

This item controls RAS# active to Protegra, and refresh to RAS# active delay (in local memory clocks).

The Choice: Fast, Slow.

RAS# Precharge Timing

This item controls RAS# precharge (in local memory clocks).

The choice: Fast, Slow.

4-4 Integrated Peripherals

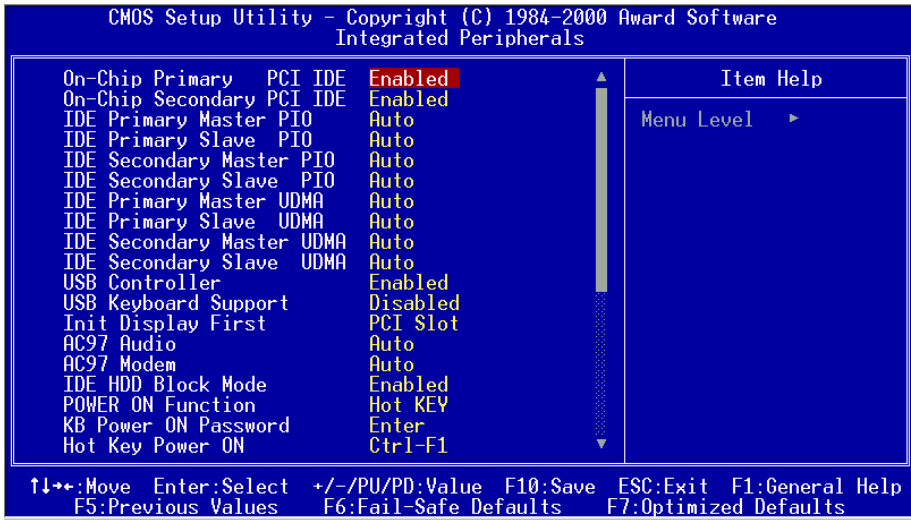

OnChip Primary/Secondary PCI IDE

The integrated peripheral controller contains an IDE interface with support for two IDE channels. Select *Enabled* to activate each channel separately.

The choice: Enabled, Disabled.

IDE Primary/Secondary Master/Slave PIO

The four IDE PIO (Programmed Input/Output) fields let you set a PIO mode (0-4) for each of the four IDE devices that the onboard IDE interface supports. Modes 0 through 4 provide successively increased performance. In Auto mode, the system automatically determines the best mode for each device.

The choice: Auto, Mode 0, Mode 1, Mode 2, Mode 3, Mode 4.

IDE Primary/Secondary Master/Slave UDMA

Ultra DMA/33 implementation is possible only if your IDE hard drive supports it and the operating environment includes a DMA driver (Windows 95 OSR2 or a third-party IDE bus master driver). If your hard drive and your system software both support Ultra DMA/33, select Auto to enable BIOS support.

The Choice: Auto, Disabled.

USB Controller

Select *Enabled* if your system contains a Universal Serial Bus (USB) controller and you have USB peripherals.

The choice: Enabled, Disabled.

USB Legacy Device Support

Select *Enabled* if your system contains a Universal Serial Bus (USB) controller and you have a USB Legacy Device (Keyboard, Mouse).

The choice: Enabled, Disabled.

Init Display First

This item allows you to decide to active whether PCI Slot or on-chip VGA first

The choice: PCI Slot, Onboard .

AC97 Audio

This item allows you to decide to Auto/disable the 815 chipset family to support AC97 Audio.

The function setting AC97 Audio Codec states. The system default is Auto.

AC97 Modem

This item allows you to decide to enable/disable the ICH2 chipset family to support AC97 Modem.

Select Enable of AC97 Modem item, you must be primary Modem Riser Card (MR) in hardware.

The choice: Auto, Disabled.

IDE HDD Block Mode

Block mode is also called block transfer, multiple commands, or multiple sector read/write. If your IDE hard drive supports block mode (most new drives do), select Enabled for automatic detection of the optimal number of block read/writes per sector the drive can support.

The choice: Enabled, Disabled

Power On Function

There are “**Button Only**”, “**Hot Key**” and “**Any key**” can be chosen by this field that allows users to select one of these various functions as Power On Method for their requirement. The default value in this selection is “ Hot Key”. (Ctrl-F1)

BIOS

- Hot Key:** User can press “Control Key” (Ctrl) and “Function Key” (from F1 to F12) individually to power on the system. The interval between “Ctrl” key and function Key (F1-F12) must be short.
- Anykey:** Press anykey to power on the system.
- Button Only:** This power on function controlled by J3 (pw-on.) Use Power On Button to power on the system.
- Password:** User can Power On the System by password, the password can be entered from 1 to 5 characters. The maximum of password is 5 characters. If user forget / lost the password, please turn off the system and open case to clear CMOS by JP1 to re-setting the power on function. When set the password to turn on the system, than can't power on by J3(PW-ON).

KB Power On Password

When the option of “Power On Function” is password selected, user uses the item to key in password.

Hot Key Power On

Use this option with the above “Power On Function” to set a combination of keys that can be used to power the system on. The default is Ctrl-F1.

Options: Ctrl-F1, Ctrl-F2, Ctrl-F3, Ctrl-F4, Ctrl-F5, Ctrl-F6, Ctrl-F7, Ctrl-F8, Ctrl-F9, Ctrl-F10, Ctrl-F11, and Ctrl-F12.

Onboard FDC Controller

Select Enabled if your system has a floppy disk controller (FDC) installed on the system board and you wish to use it. If you install and-in FDC or the system has no floppy drive, select Disabled in this field.

The choice: Enabled, Disabled.

Onboard Serial Port 1/Port 2

Select an address and corresponding interrupt for the first and second serial ports.

The choice: 3F8/IRQ4, 2E8/IRQ3, 3E8/IRQ4, 2F8/IRQ3, Disabled, Auto.

UART Mode Select

This field allows the users to configure what IR mode the 2nd serial port should use.

The default is Normal.

Optional: Normal, IrDA and ASKIR.

RxD, TxD Active

This field configures the receive and transmit signals generated from the IR port. The default is Hi Lo (when UART Mode Select is not set to Normal).
Options: Hi Hi, Hi Lo, Lo Hi, and Lo Lo.

IR Transmission delay

The default is Enabled (when UART Mode Select is not set to Normal).
Options: Enabled and Disabled.

Onboard Parallel port

This field allows the user to configure the LPT port.
The default is 378H / IRQ7.

378H: Enable Onboard LPT port and address is 378H and IRQ7.

278H: Enable Onboard LPT port and address is 278H and IRQ5.

3BCH: Enable Onboard LPT port and address is 3BCH and IRQ7.

Disabled: Disable Onboard LPT port.

Parallel Port Mode

This field allows the user to select the parallel port mode.
The default is ECP+EPP.

EPP: Enhanced Parallel Port mode.

ECP: Extended Capabilities Port mode.

EPP+ECP: ECP Mode & EPP Mode.

EPP Mode Select

This item allows you to determine the IR transfer mode of onboard I/O chip.
options: EPP1.9, EPP1.7.

ECP Mode USE DMA

This field allows the user to select DMA1 or DMA3 for the ECP mode.
The default is DMA3.

DMA1: This field selects the routing of DMA1 for the ECP mode.

DMA3: This field selects the routing of DMA3 for the ECP mode.

PWRON After PW-Fail

The system will stay off or power on after a power interrupt.
The default is OFF.

BIOS

Fomer-Status: Stay off or power on depend on system safe shut-down or power fail.

ON: System always power on after a power interrupte.

OFF: System always stay off after a power interrupte.

Game Port Address

Select an address for the Game port.

The choice: 201, 209, Disabled.

Midi Port Address

Select an address for the Midi port.

The choice: 290, 300, 330, Disabled.

Midi Port IRQ

Select an interrupt for the Midi port.

The choice: 5, 10.

4-5 Power Management Setup

The Power Management Setup allows you to configure your system to most effectively save energy while operating in a manner consistent with your own style of computer use.

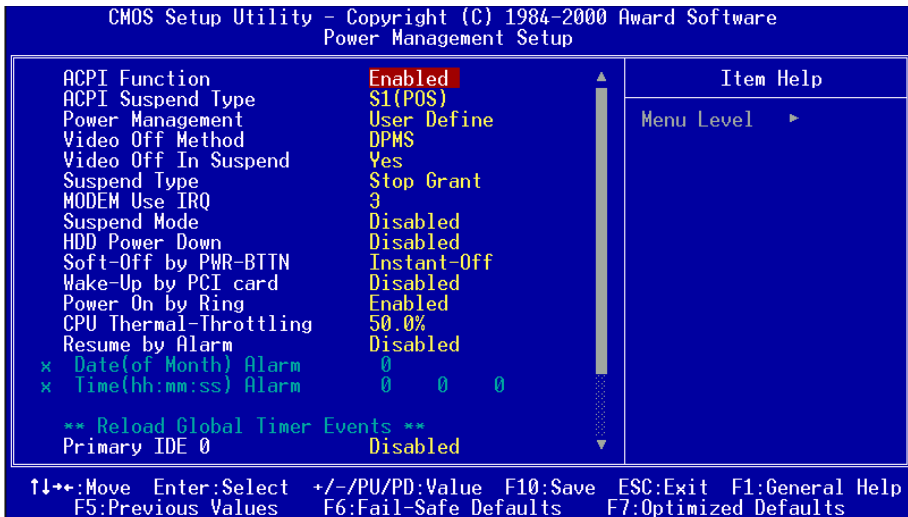

ACPI Function

This item allows you to enable/disable the Advanced Configuration and Power Management (ACPI).

The choice: Enabled, Disabled.

ACPI Suspend Type

This item allows you to select S1(POS) or S3(STR) function.

The choice: S1(POS), S3(STR).

Power Management

This category allows you to select the type (or degree) of power saving and is directly related to the following modes:

1. HDD Power Down
2. Doze Mode
3. Suspend Mode

BIOS

There are four selections for Power Management, three of which have fixed mode settings.

Disable (default)	No power management. Disables all four modes
Min. Power Saving	Minimum power management. Doze Mode = 1 hr. Standby Mode = 1 hr., Suspend Mode = 1 hr., and HDD Power Down = 15 min.
Max. Power Saving	Maximum power management -- ONLY AVAILABLE FOR SL CPU's . Doze Mode = 1 min., Standby Mode = 1 min., Suspend Mode = 1 min., and HDD Power Down = 1 min.
User Defined	Allows you to set each mode individually. When not disabled, each of the ranges are from 1 min. to 1 hr. except for HDD Power Down which ranges from 1 min. to 15 min. and disable.

Video Off Method

This determines the manner in which the monitor is blanked.

V/H SYNC+Blank	This selection will cause the system to turn off the vertical and horizontal synchronization ports and write blanks to the video buffer.
Blank Screen	This option only writes blanks to the video buffer.
DPMS	Initial display power management signaling.

Video Off In Suspend

This determines the manner in which the monitor is blanked.

The choice: Yes, No.

Suspend Type

Select the Suspend Type.

The choice: PWRON Suspend, Stop Grant.

MODEM Use IRQ

This determines the IRQ in which the MODEM can use.

The choice: 3, 4, 5, 7, 9, 10, 11, NA.

Suspend Mode

When enabled and after the set time of system inactivity, all devices except the CPU will be shut off.

The choice: Enabled, Disabled.

HDD Power Down

When enabled and after the set time of system inactivity, the hard disk drive will be powered down while all other devices remain active.

The choice: Enabled, Disabled.

Soft-Off by PWR-BTTN

Pressing the power button for more than 4 seconds forces the system to enter the Soft-Off state when the system has “hung.” The default is Instant-off.

The choice: Delay 4 Sec, Instant-Off.

PowerOn By Ring

This option is used to set the remote ring in and Wake on LAN (WOL) features.

The choice: Enabled, Disabled.

CPU Thermal-Throttling

Select the CPU THRM-Throttling rate.

The choice: 25.0%, 37.5%, 50.0%, 62.5%, 75.0%, 87.5%.

Resume by Alarm

This option allows you to have the system turn on at a present time each day or on a certain day.

The choice: Disabled, Enabled.

**** PM Events ****

PM events are I/O events whose occurrence can prevent the system from entering a power saving mode or can awaken the system from such a mode. In effect, the system remains alert for anything which occurs to a device which is configured as *Enabled*, even when the system is in a power down mode.

Primary IDE 0

Primary IDE 1

Secondary IDE 0

Secondary IDE 1

FDD, COM, LPT Port

PCI PIRQ[A-D] #

4-6 PnP/PCI Configuration Setup

This section describes configuring the PCI bus system. PCI, or **Personal Computer Interconnect**, is a system which allows I/O devices to operate at speeds nearing the speed the CPU itself uses when communicating with its own special components. This section covers some very technical items and it is strongly recommended that only experienced users should make any changes to the default settings.

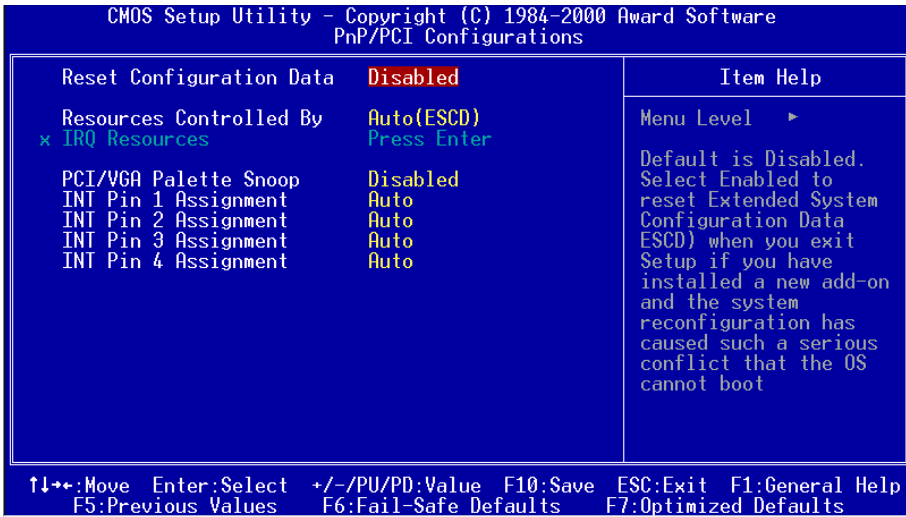

Reset Configuration Data

Normally, you leave this field Disabled. Select Enabled to reset Extended System Configuration Data (ESCD) when you exit Setup if you have installed a new add-on and the system reconfiguration has caused such a serious conflict that the operating system can not boot.

The choice: Enabled, Disabled .

Resource controlled by

The Award Plug and Play BIOS has the capacity to automatically configure all of the boot and Plug and Play compatible devices. However, this capability means absolutely nothing unless you are using a Plug and Play operating system such as Windows95. If you set this field to “manual” choose specific resources by going

into each of the sub menu that follows this field (a sub menu is preceded by a “Ø”).
 The choice: Auto(ESCD), Manual.

PCI/VGA Palette Snoop

Leave this field at *Disabled*.

Choices are Enabled, Disabled.

INT Pin1 to Pin4 Assignment

These settings allow the user to specify what IRQ will be assigned to PCI devices in the chosen slot. Options available: Auto,3,4,5,7,9,10,11,12,14 & 15. The defaults are Auto.

4-7 PC Health Status

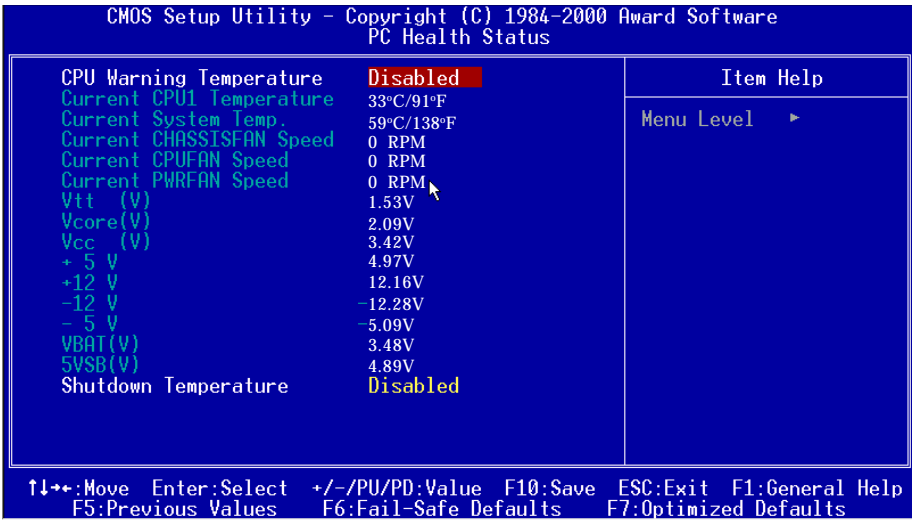

CPU Warning Temperature

This is the temperature that the computer will respond to an overheating CPU. The default is Disabled.

Enabled: Temperature is monitored on the CPU, default is 95°C/205°F.

Disabled: This feature is turned off.

BIOS

Current CPU Temperature

This is the current temperature of the CPU.

Current System Temp

This is the Current temperature of the system.

Current CPU Fan/ Power Fan/ Chassis Fan Speed

The current CPU fan speed in RPMs.

CPU(V)

The voltage level of the Vtt, Vcore, Vcc.

+5V, +12V, -12V, -5V, VBAT, 5VSB: The voltage level of the switch power supply.

Shutdown Temperature

This is the temperature that the computer will turn off the power to combat the effects of an overheating system. (requires ACPI to be enabled in Power Management BIOS and ACPI compliant operating system.) The default is Disabled.

Options available are 60°C/140°F to 100°C/212°F in increments of 5°C.

4-8 Frequency/Voltage Control

CMOS Setup Utility - Copyright (C) 1984-2000 Award Software Frequency/Voltage Control		Item Help
System Memory Frequency	Auto	
Auto Detect DIMM/PCI Clk	Enabled	
Spread Spectrum Modulated	Disabled	
x Linear Spread Model	3	
x Linear Spread Range	0	
CPU/SDRAM/AGP/PCI Clock	66/100/66/33	
CPU Clock Ratio	X 3	
Default CPU Vcore Voltage	1.65V	
CPU Vcore Voltage	+0.00V	
New CPU Vcore Voltage	1.65V	
↑↓←→:Move Enter:Select +/-/PU/PD:Value F10:Save ESC:Exit F1:General Help F5:Previous Values F6:Fail-Safe Defaults F7:Optimized Defaults		

System Memory Frequency

Setting the SDRAM frequency. The default is Auto.

The choice: 100Mhz, 133MHz, Auto.

Note: When the CPU host (FSB) is 100MHz, then SDRAM frequency is fixed at 100MHz. This item is not show automatically on screen.

Auto Detect DIMM/PCI Clk

This item allows you to enable/disable auto detect DIMM/PCI Clock.

The choice: Enabled, Disabled.

CPU/SDRAM/AGP/PCI Clock

The mainboard is designed to set the CPU/SDRAM/AGP/PCI clock at jumperfree.

This item allows you to select the CPU Host, SDRAM,AGP speed and PCI clock speed by “Enter” key. If “default” is means the CPU Host speed that depend on the CPU is 100MHz or 133MHz.

Note: Press *Insert* key can bypass overclock setting when system just booting (Cold boot or Warm boot). If you set the clock frequency to be too high, then the system will not turn on again (no display). This function can help you to run normal clock (Default FSB Clock) and bypass overclock failure.

BIOS

CPU Clock Ratio

This item allows you to select the CPU ratio. If the CPU ratio is fixed. This item was no function. Configuration options: [3.x]...[7x], [7.5x], [8.x].

CPU Vcore Voltage

This item allows you to increase the CPU Vcore Voltage.

4-9 Defaults Menu

Selecting “Defaults” from the main menu shows you two options which are described below

Load Fail-Safe Defaults

When you press <Enter> on this item you get a confirmation dialog box with a message similar to:

Load Fail-Safe Defaults (Y/N) ? N

Pressing ‘Y’ loads the BIOS default values for the most stable, minimal-performance system operations.

Load Optimized Defaults

When you press <Enter> on this item you get a confirmation dialog box with a message similar to:

Load Optimized Defaults (Y/N) ? N

Pressing ‘Y’ loads the default values that are factory settings for optimal performance system operations.

4-10 Supervisor/User Password Setting

You can set either supervisor or user password, or both of them. The differences between are:

supervisor password : can enter and change the options of the setup menus.

user password : just can only enter but do not have the right to change the options of the setup menus. When you select this function, the following message will appear at the center of the screen to assist you in creating a password.

ENTER PASSWORD:

Type the password, up to eight characters in length, and press <Enter>. The password typed now will clear any previously entered password from CMOS memory. You will be asked to confirm the password. Type the password again and press <Enter>. You may also press <Esc> to abort the selection and not enter a password. To disable a password, just press <Enter> when you are prompted to enter the password. A message will confirm the password will be disabled. Once the password is disabled, the system will boot and you can enter Setup freely.

PASSWORD DISABLED.

When a password has been enabled, you will be prompted to enter it every time you try to enter Setup. This prevents an unauthorized person from changing any part of your system configuration.

Additionally, when a password is enabled, you can also require the BIOS to request a password every time your system is rebooted. This would prevent unauthorized use of your computer.

You determine when the password is required within the BIOS Features Setup Menu and its Security option (see Section 3). If the Security option is set to "System", the password will be required both at boot and at entry to Setup. If set to "Setup", prompting only occurs when trying to enter Setup.

4-11 Exit Selecting

Save & Exit Setup

Pressing <Enter> on this item asks for confirmation:

Save to CMOS and EXIT (Y/N)? Y

Pressing “Y” stores the selections made in the menus in CMOS – a special section of memory that stays on after you turn your system off. The next time you boot your computer, the BIOS configures your system according to the Setup selections stored in CMOS. After saving the values the system is restarted again.

Exit Without Saving

Pressing <Enter> on this item asks for confirmation:

Quit without saving (Y/N)? Y

This allows you to exit Setup without storing in CMOS any change. The previous selections remain in effect. This exits the Setup utility and restarts your computer.

Section 5 815 Series VGA and Sound Driver Installation

Easy Driver Installation

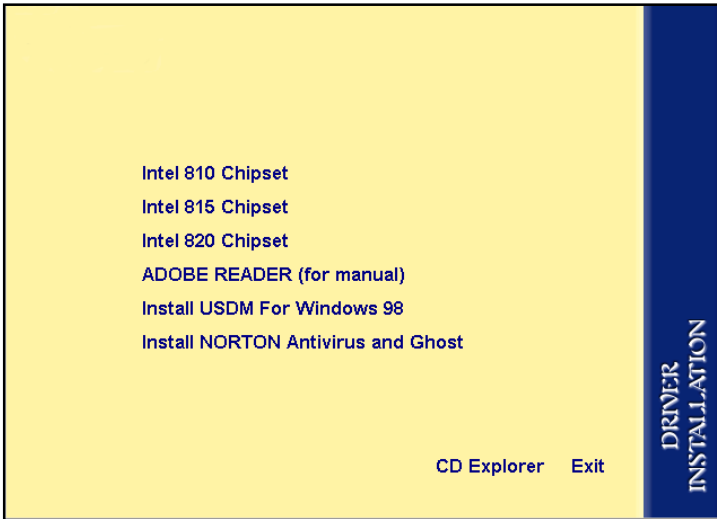

To Click the Intel 815 chipset that enable the Intel(R) 815 Chipsets to be recognized by listed operating systems. This installer will unpack updated .INF files into a specified folder. Supported operating systems: Microsoft Windows* 95 OSR 2.1+ and Windows* 98 operating systems.

Appendix A

NOTE:

The "**LOAD Optimized DEFAULTS**" function loads the system default data directly from ROM and initializes the associated hardware properly. This function will be necessary when you accept this mainboard, or the system CMOS data is corrupted.

CMOS Setup Utility - Copyright (C) 1984-1998

Standard CMOS Feature	Frequency/Voltage Control
Advanced BIOS Feature	Load Fail-Safe Defaults
Advanced Chipset Feature	Load Optimized Defaults
Integrated Peripherals	Set Supervisor Password
Power Management Setup	Load Optimized Defaults (Y/N)? Y
PnP/PCI Configuration	
PC Health Status	Exit Without Saving
Esc : Quit	↑ ↓ ← → : Select Item
F10 : Save & Exit Setup	
Time, Date, Hard Disk Type....	

LOAD Optimized DEFAULTS

B-1 GHOST 5.1 Quick User's Guide

Installation is very easy. You only need to copy the **Ghost5** folder or **Ghost.exe** to your hard disk.

The current market version is for single **Client**, so the LPT and NetBios portions will not be explained further.

Description of Menus

Ghost clones and backs up **Disk** and **Partition**.

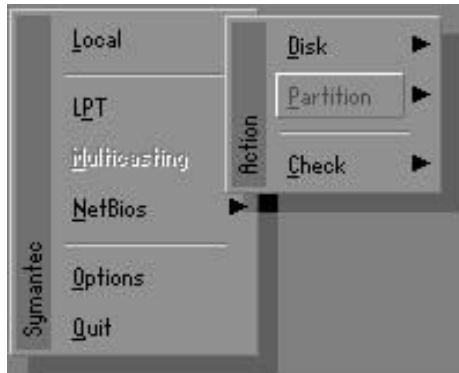

In which **Disk** indicates hard disk options
Partition indicates partition options
Check indicates check options

Disk

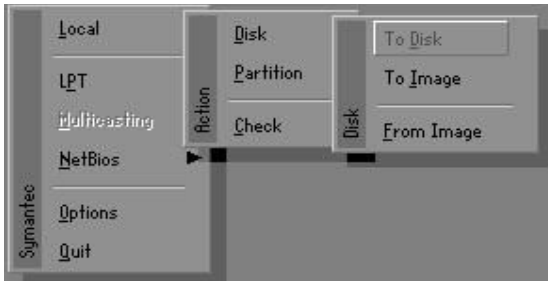

Appendix

There are 3 hard disk functions:

1. Disk To Disk (disk cloning)
2. Disk To Image (disk backup)
3. Disk From Image (restore backup)

Important!

1. To use this function, the system must have at least 2 disks. Press the **Tab** key to move the cursor.
2. When restoring to a destination disk, all data in that disk will be completely destroyed.

Disk To Disk (Disk Cloning)

1. Select the location of the **Source** drive.
2. Select the location of the **Destination** drive.

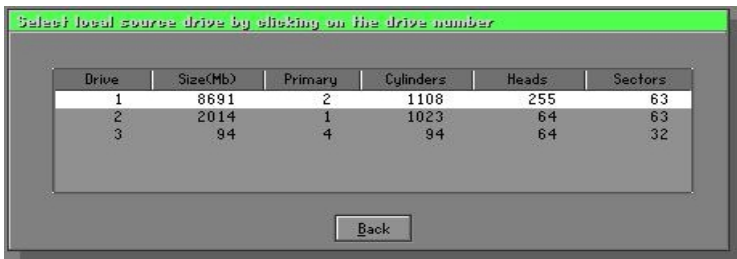

3. When cloning a disk or restoring the backup, set the required partition size as shown in the following figure.

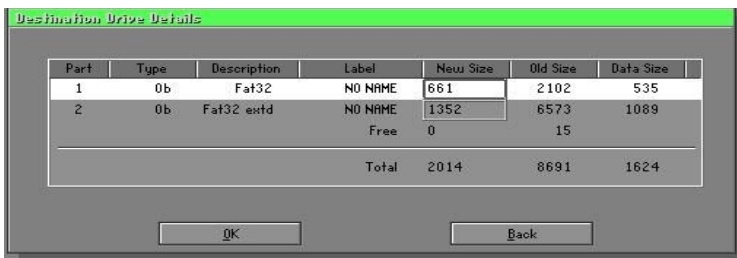

- Click OK to display the following confirmation screen. Select **Yes** to start.

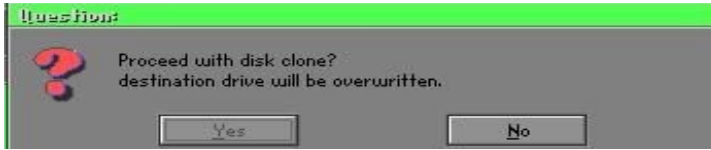

Disk To Image (Disk Backup)

- Select the location of the Source drive.

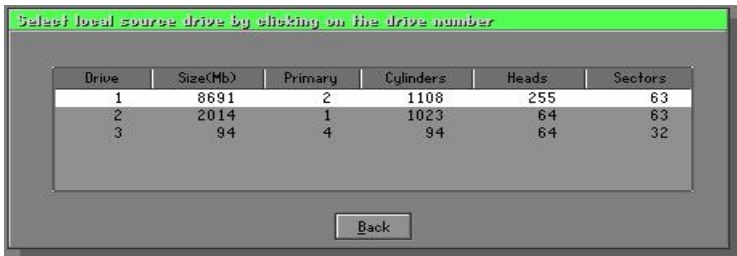

- Select the location for storing the backup file.

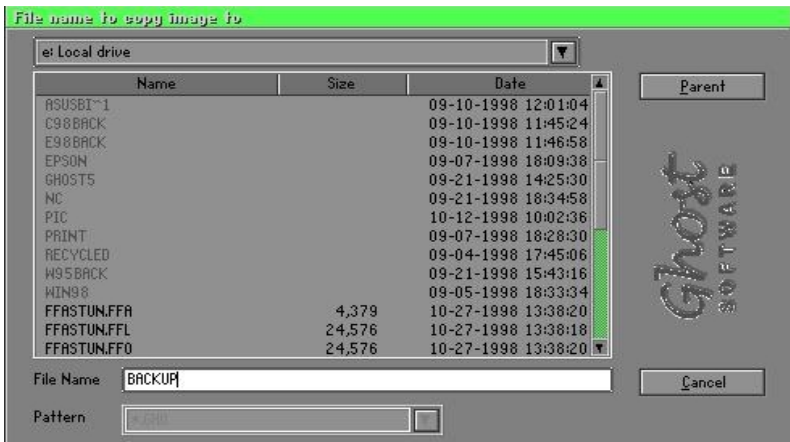

Appendix

- Click **OK** to display the following confirmation screen. Select **Yes** to start.



Disk From Image (Restore Backup)

- Select the Restore file.

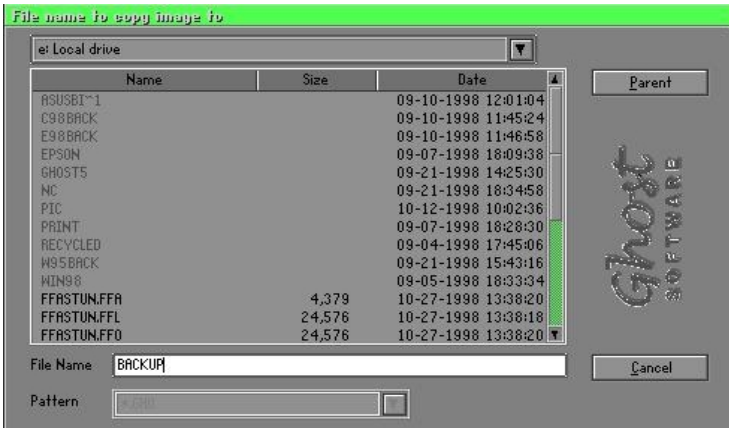

- Select the **Destination** drive of the disk to be restored.

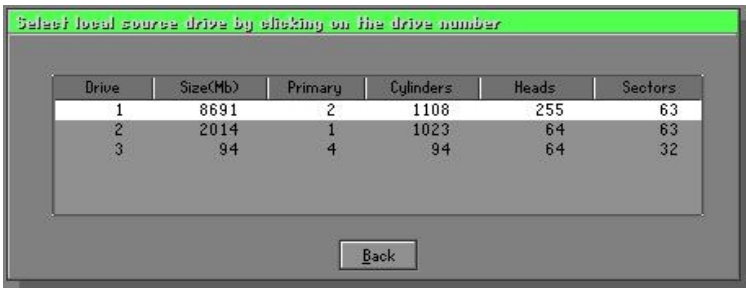

- When restoring disk backup, set the required partition size as shown in the following figure.

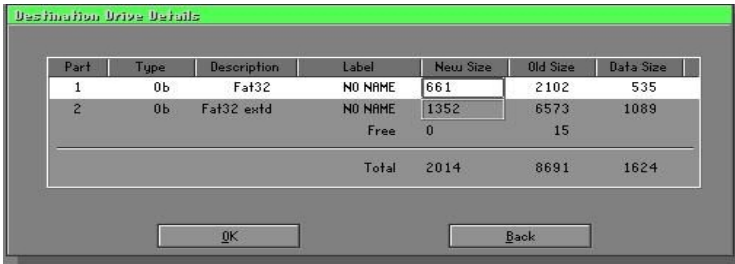

- Click **OK** to display the following confirmation screen. Select **Yes** to start.

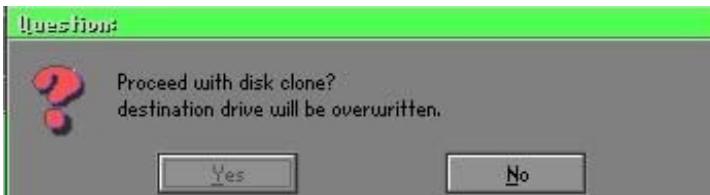

Partition

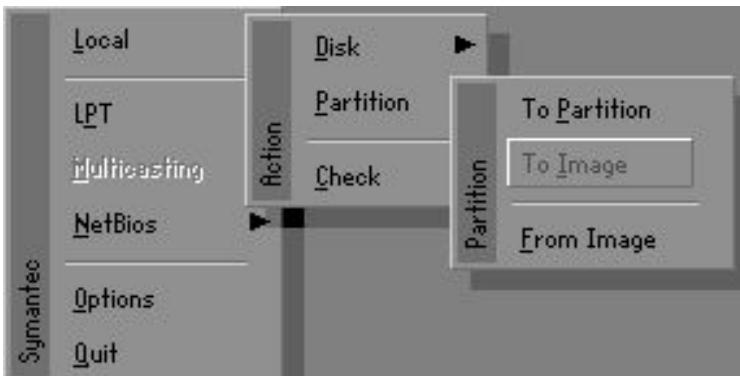

Appendix

There are 3 partition functions:

1. **Partition To Partition** (partition cloning)
2. **Partition To Image** (partition backup)
3. **Partition From Image** (restore partition)

Partition To Partition (Partition Cloning)

The basic unit for partition cloning is a partition. Refer to disk cloning for the operation method.

Partition To Image (Partition Backup)

1. Select the disk to be backed up.

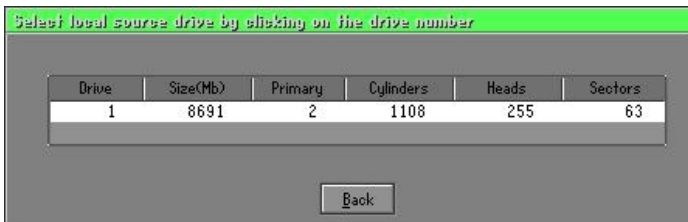

2. Select the first partition to be backed up. This is usually where the operating system and programs are stored.



3. Select the path and file name for storing the backup file.

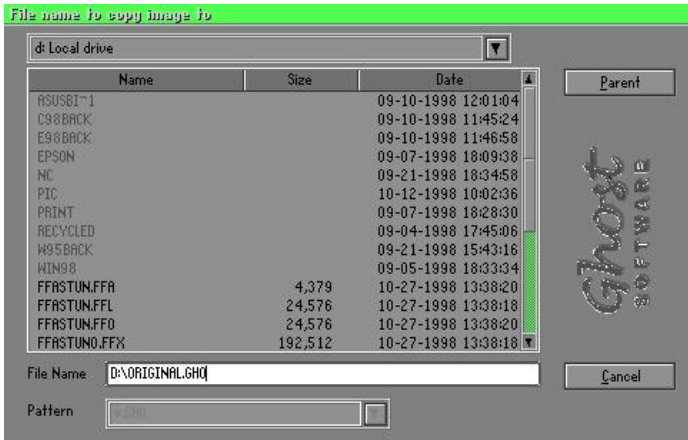

4. Is the file compressed? There are 3 options:

- (1) No: do not compress data during backup
- (2) Fast: Small volume compression
- (3) High: high ratio compression. File can be compressed to its minimum, but this requires longer execution time.

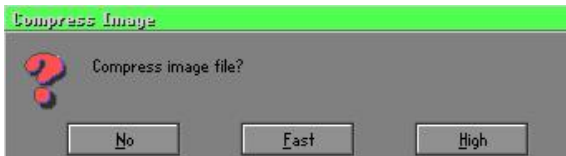

5. During confirmation, select Yes to start performing backup.



Appendix

Partition From Image (Restore Partition)

1. Select the backup file to be restored.

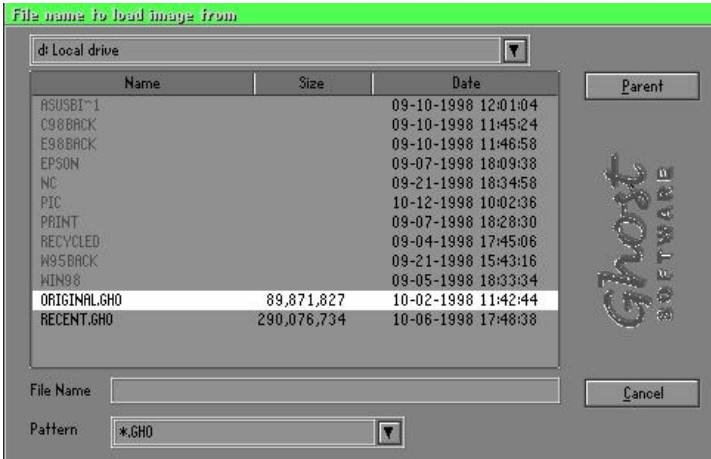

2. Select the source partition.

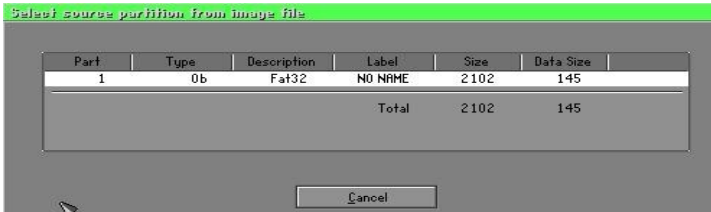

3. Select the disk to be restored.



4. Select the partition to be restored.

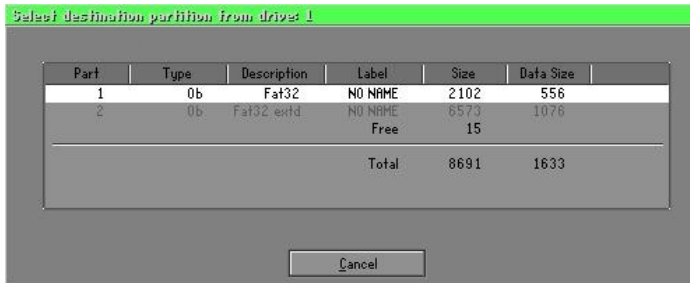

5. Select Yes to start restoring.

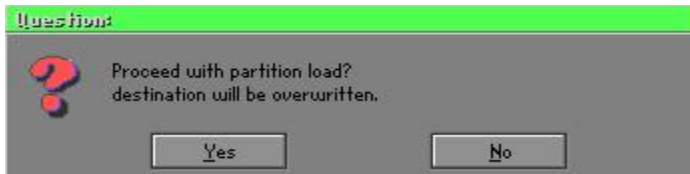

Check

This function checks the hard disk or backup file for backup or restoration error due to FAT or track error.

How to Reinstall Windows in 2 Minutes

This chapter teaches you how to set your computer properly and, if necessary, reinstall Windows in 2 minutes. Ghost can use different methods to complete this task. The following two sections explain the creation of the emergency Recover Floppy and Recover CD:

Emergency Recover Floppy

Divide a hard disk into two partitions. The first partition is for storing the operating system and application programs. The second partition is for backing up the operating system and data. The size of the partition can be set according to the backup requirements. For example, the **Windows** operating system needs 200MB of hard disk space, while the complete **Office** installation requires 360MB. The remaining space can be used to store other data.

After installing **Windows**, use **Ghost** to create a backup of the source system and store the file (Image file) in drive D. The file is named as **Original.gho**. Then, create a recover floppy disk containing:

- ◆ Bootable files (Command.com, Io.sys, and MSDOS.SYS)
- ◆ Config.sys (configuration setup file)
- ◆ Autoexec.bat (auto-execution batch file)
- ◆ Ghost.exe (Ghost execution file)

There are two ways to set the content of the recover floppy for restoration:

- (1) To load **Windows** automatically after booting, set the **Autoexec.bat** command as:

```
Ghost.exe clone, mode=pload, src=d:\original.gho:2,dst=1:1 -fx -sure -rb
```

Description: Runs the restore function automatically using the Image File. After execution, it exits Ghost and boots the system automatically.

Refer to the [Introducing Ghosts Functions].

- (2) After booting, the screen displays the Menu. Select Backup or Restore: Since the user may install other applications in the future, he/she may design **Autoexec.bat** as a Menu to back up or restore the user-defined Image file as follows:

Backup

Back up Windows and application programs as a file (Recent.gho). Command is:

```
Ghost -clone,mode=pdump,src=1:1,dst=d:\Recent.gho -fx -sure -rb
```

Restore

Restore types include [**General Windows**] and [**Windows and Application Programs**]. If you select [**General Windows**], the system is restored to the general **Windows** operation condition. The command is:

```
Ghost.exe -clone,mode=pload,src=d:\Original.gho,dst=1:1 -fx -sure -rb
```

If you select [**Windows and Application Programs**], the latest backup file (Recent.gho) is restored, skipping the installation and setup of application programs.

For description of relevant parameters, refer to [**Introducing Ghosts Functions**].

For more information about menu design, refer to Config.sys and Autoexec.bat under /Menu in the CD. You can also create a backup CD containing Ghost.exe and these two files.

Recover CD

In recent years, well-known computer manufacturers (such as IBM, Acer, Compaq, etc.) bundle Recover CDs with their computers to reduce the cost resulting from servicing, while at the same time increasing their market competitiveness.

The following is a simple guide to how to create a recover CD:

1. For extremely easy creation of the recover floppy disk, use the copy program for example "Easy CD Creator" (Note 2). First, create a recover floppy disk containing:

Bootable files (Command.com and Io.sys and MSDOS.SYS)

Config.sys (Configuration setup file)

Autoexec.bat (Auto-execution batch file)

Mscdex.exe (CD-Rom execution file)

Ghost.exe (Ghost execution file)

Oakcdrom.sys (ATAPI CD-ROM compatible driver)

The content of Config.sys is:

```
DEVICE=Oakcdrom.sys /d:idecd001
```

The content of Autoexec.bat includes:

```
MSCDEX.EXE /D:IDECD001 /L:Z
```

```
Ghost.exe clone,mode=load,src=z:\original.gho,dst=1 -sure -rb
```

2. Write the backup image file (original.gho) of the entire hard disk or partition into the recover CD. Use the Recover CD to boot up the system and restore the backup files automatically.

For description of relevant parameters, refer to **[Introducing Ghosts Functions]**.

Note: For more details regarding the creation program and method for creating the recover CD, please refer to the legal software and relevant operation manual.

Ghost Command Line Switches Reference

Ghost may be run in interactive or in batch mode. Batch mode is useful for automating installations for backups using Ghost. Most of the Ghost switches are used to assist with batch mode operation. To list switches from Ghost, type `ghost.exe -h`.

-clone

The full syntax for this switch is:

```
clone,MODE={copy|load|dump|pcopy|pload|pdump},SRC={drive|file|drive:partition},DST={drive|file|drive:partition},SIZE {F|L|n={nnnnM|nnP|F|V}}
```

Clone using arguments. This is the most useful of the batch switches and has a series of arguments that define:

- a) MODE** This defines the type of clone command to be used:
- COPY** disk to disk copy
 - LOAD** file to disk load
 - DUMP** disk to file dump
 - PCOPY** partition to partition copy
 - PLOAD** file to partition load
 - PDUMP** partition to file dump
- b) SRC** This defines the source location for the operation:
- | Mode | Meaning: |
|---------------|---|
| COPY/ | |
| DUMP | Source drive (e.g, 1 for drive one) |
| LOAD | Disk image filename or device (e.g, g:\Images\system2.img) |
| PCOPY/ | |
| PDUMP | Source partition e.g, 1:2 indicates the second partition on drive one. |
| PLOAD | Partition image filename or device and partition number. Example: g:\images\disk1.img:2 indicates the second partition in the Image file. |

Appendix

- c) **DST** This defines the destination location for the operation:
- | Mode | Meaning |
|---------------|---|
| COPY/ | |
| LOAD | Destination drive (e.g, 2 for drive two) |
| DUMP | Disk image filename or device,(e.g, g:\images\system2.img) |
| PCOPY/ | |
| PLOAD | Destination partition,(e.g, 2:2 indicates the second partition on drive two). |
| PDUMP | Partition image filename (e.g, g:\images\part1.img). |
- c) **SZEy** Used to set the size of the destination partitions for either a disk load or disk copy operation.

Available y Options:

- F Resizes the first partition to maximum size allowed based on file system t type.
- L Resizes the last partition to maximum size allowed based on file system type.
- n=xxxxM - indicates that the n?h destination partition is to have a size of xxxx Mb. (e.g, SZE2=800M indicates partition two is to have 800 mb.) n=mmP - indicates that the n?h destination partition is to have a size of mm percent of the target disk.
- n=F - indicates that the n?h destination partition is to remain fixed in size.
- n=V - Indicates that the partition will be resized according to the following rules:
- Rule 1** - If the destination disk is larger than the original source disk, then the partition(s) will be expanded to have the maximum amount of space subject to the free space available and the partition type (e.g, FAT16 partitions will have a maximum size of 2048Mb.)
- Rule 2** - If the destination disk is smaller than the original source disk, (but still large enough to accommodate the data from the source disk), the free space left over after the

data space has been satisfied will be distributed between the destination partitions in proportion to the data usage in the source partitions. Some examples follow that will help illustrate:

- fx flag Exit. Normally when Ghost has finished copying a new system to a disk, it prompts the user to reboot with a press Ctrl-Alt-Del to reboot window. However, if Ghost is being run as part of a batch file it is sometimes useful to have it just exist back to the DOS prompt after completion so that further batch commands may be processed. -fx enables this. See -rb for another option on completing a clone.
- ia Image All. The Image All switch forces Ghost to do a sector by sector copy of all partitions. When copying a partition from a disk to an image file or to another disk, Ghost examines the source partition and decides whether to copy just the files and directory structure, or to do an image (sector by sector) copy. If it understands the internal format of the partition it defaults to copying the files and directory structure. Generally this is the best option, but occasionally if a disk has been set up with special hidden security files that are in specific positions on the partition, the only way to reproduce them accurately on the target partition is via an image or sector-by-sector copy.
- span enables spanning across volumes.
- split=x splits image file into 'x' Mb? Mb spans. Use this to create a 'forced' size volume set. For example, if you would like to force smaller image files from a 1024 Megabyte drive, you could specify 200 megabyte segments. For example, ghost.exe -split=200 will divide the image into 200 Megabyte segments.
- sure use the -sure switch in conjunction with -clone to avoid being prompted with the final 'Proceed with disk clone destination drive will be overwritten?' question. This command is useful in batch mode.

Appendix

Example 1:

To copy drive one to drive two on a PC, without final prompt if OK to proceed.

```
ghost.exe -clone,mode=copy,src=1,dst=2 -sure
```

Example 2:

To connect via NetBIOS to another PC running Ghost in slave mode, and dump a disk image of local drive two to the remote file c:\drive2.gho

```
ghost.exe -clone,mode=dump,src=2,dst=C:\drive2.gho -nbm
```

Note: The slave Ghost can be started with `ghost -nbs`

Example 3:

To copy drive one, second partition on a PC to drive two, first partition the same PC, without final prompt

```
ghost.exe -clone,mode=pcopy,src=1:2,dst=2:1 -sure
```

Example 4:

To dump the second partition of drive one to an image file on a mapped drive g:

```
ghost.exe -clone,mode=pdump,src=1:2,dst=g:\part2.gho
```

Example 5:

To load partition 2 from a two-partition image file on a mapped drive g: onto the second partition of the local disk

```
ghost -clone,mode=pload,src=g:\part2.gho:2,dst=1:2
```

Example 6:

To load drive 2 from an image file and resize the destination partitions into a 20:40 allocation

```
ghost.exe -clone,mode=load,src=g:\2prtdisk.gho,dst=2,size1=60P,  
size2=40P
```

User Notice

No part of this product, including the product and software may be reproduced, transmitted, transcribed, stored in a retrieval system, or translated into any language in any form without the express written permission of EPoX Computer Company (hereinafter referred to as EPoX) except for documentation kept by the purchaser for backup purposes.

We provide this manual “as is” without warranty of any kind, either expressed or implied, including but not limited to the implied warranties or conditions of merchantability or fitness for a particular purpose. In no event shall EPoX be liable for any loss of profits, loss of business, loss of use or data, interruption of business or for indirect, special incidental, or consequential damages of any kind, even if EPoX has been advised of the possibility of such damages arising from any defect or error in the manual or product. EPoX may revise this manual from time to time without notice. For updated BIOS, drivers, or product release information you may visit our websites at <http://www.epox.com> or <http://www.epox.com.tw>.

Products mentioned in this manual are mentioned for identification purposes only. Product names appearing in this manual may or may not be registered trademarks or copyrights of their respective companies. **The product name and revision number are both printed on the mainboard itself.**

Handling Procedures

Static electricity can severely damage your equipment. Handle the EP-3S2A5 and any other device in your system with extreme care and avoid unnecessary contact with system components on the mainboard. Always work on an antistatic surface to avoid possible damage to the mainboard from static discharge. Always have the power supply unplugged and powered off when inserting and removing devices within the computer chassis. EPoX assumes no responsibility for any damage to the EP-3S2A5 mainboard that results from failure to follow instruction or failure to observe safety precautions.



CAUTION



The EP-3S2A5 mainboard is subject to damage by static electricity. Always observe the handling procedures.

Technical Support Services

If you need additional information, help during installation or normal use of this product, please contact your retailer. Your retailer will have the most current information about your configuration. If your retailer cannot help, you may visit our online technical support website and/or contact our support technicians at the locations listed below.

Record your serial number before installing your EP-3S2A5 mainboard. (The serial number is located near the ISA slots at the edge of the board.)

EP-3S2A5 serial number: _____

Contacting Technical Support

EPoX technical support is working hard to answer all of your questions online. From our website you can find answers to many common questions, drivers, BIOS updates, tech notes, and important technical bulletins. If you are still unable to locate the solution you are seeking, you always have the option to contact our support technicians directly.

North American website (English language)

<http://www.epox.com>

sales@epox.com

support@epox.com

European website (Multi-language)

<http://www.epox.nl>

sales@epox.nl

support@epox.nl

info@elito-epox.com

Taiwan website (Chinese language)

<http://www.epox.com.tw>

sales@epox.com.tw

support@epox.com.tw

Thank you for using EPoX mainboards!

Copyright 2000 EPoX Computer Company. All rights reserved.
