



EP-6CXA2C

**A Pentium® II or Pentium® III
Slot1 Processor based AGP (4X)
mainboard (100/133MHz)**

TRADEMARK

All products and company names are trademarks or registered trademarks of their respective holders.

These specifications are subject to change without notice.

*Manual Revision 1.0
October 26, 1999*

User Notice

No part of this product, including the product and software may be reproduced, transmitted, transcribed, stored in a retrieval system, or translated into any language in any form without the express written permission of EPoX Computer Company (hereinafter referred to as EPoX) except for documentation kept by the purchaser for backup purposes.

We provide this manual “as is” without warranty of any kind, either expressed or implied, including but not limited to the implied warranties or conditions of merchantability or fitness for a particular purpose. In no event shall EPoX be liable for any loss of profits, loss of business, loss of use or data, interruption of business or for indirect, special incidental, or consequential damages of any kind, even if EPoX has been advised of the possibility of such damages arising from any defect or error in the manual or product. EPoX may revise this manual from time to time without notice. For updated BIOS, drivers, or product release information you may visit our websites at <http://www.epox.com> or <http://www.epox.com.tw>.

Products mentioned in this manual are mentioned for identification purposes only. Product names appearing in this manual may or may not be registered trademarks or copyrights of their respective companies. **The product name and revision number are both printed on the mainboard itself.**

Handling Procedures

Static electricity can severely damage your equipment. Handle the EP-6CXA2C and any other device in your system with extreme care and avoid unnecessary contact with system components on the mainboard. Always work on an antistatic surface to avoid possible damage to the mainboard from static discharge. Always have the power supply unplugged and powered off when inserting and removing devices within the computer chassis. EPoX assumes no responsibility for any damage to the EP-6CXA2C mainboard that results from failure to follow instruction or failure to observe safety precautions.



CAUTION



The EP-6CXA2C mainboard is subject to damage by static electricity. Always observe the handling procedures.

EP-6CXA2C

Technical Support Services

If you need additional information, help during installation or normal use of this product, please contact your retailer. Your retailer will have the most current information about your configuration. If your retailer cannot help, you may visit our online technical support website and/or contact our support technicians at the locations listed below.

Record your serial number before installing your EP-6CXA2C mainboard. (The serial number is located near the PCI slots at the edge of the board.)

EP-6CXA2C serial number: _____

Contacting Technical Support

EPoX technical support is working hard to answer all of your questions online. From our website you can find answers to many common questions, drivers, BIOS updates, tech notes, and important technical bulletins. If you are still unable to locate the solution you are seeking, you always have the option to contact our support technicians directly.

North American website (English language)

<http://www.epox.com>

sales@epox.com

support@epox.com

European website (Multi-language)

<http://www.epox.nl>

sales@epox.nl

support@epox.nl

Taiwan website (Chinese language)

<http://www.epox.com.tw>

sales@epox.com.tw

support@epox.com.tw

Thank you for using EPoX mainboards!

Copyright 1999 EPoX Computer Company. All rights reserved.

Table of Contents

<i>Section 1</i>	<i>Introduction</i>	<i>Page</i>
	Components Checklist	1-1
	<i>Overview</i>	
	Terminology	1-2
	System Overview	1-2
	Chipset Components	1-2
	Pentium® II or Pentium® III Processor	1-2
	S.E.C. Cartridge Terminology	1-3
	Direct Rambus	1-2
	Bandiwdth Overview	1-2
	Accelerated Graphics Port	1-4
	Ultra ATA/66	1-2
	Hardware Monitoring	1-4
	EP-6CXA2C Form-Factor	1-5
	I/O Shield Connector	1-6
	Power-On/Off (Remote)	1-6
	System Block Diagram	1-7
<i>Section 2</i>	<i>Features</i>	
	EP-6CXA2C Features	2-1
<i>Section 3</i>	<i>Installation</i>	
	EP-6CXA2C Detailed Layout	3-2
	<i>Easy Installation Procedure</i>	
	Configure Jumpers	3-3
	System RIMM Memory Module Configuration	3-5
	Installing a Pentium® II/III Processor	3-8
	Device Connectors	3-10
	External Modem Ring-in Power ON and Keyboard Power ON Function (KBPO)	3-12
	STR Function	1-7
<i>Section 4</i>	<i>Award BIOS Setup</i>	
	Main Menu	4-1
	Standard CMOS Setup	4-3

Advanced BIOS Features 4-7
Advanced Chipset Features 4-10
Integrated Peripherals 4-13
Power Management Setup 4-17
PNP/PCI Configuration Setup 4-20
PC Health Status 4-21
Frequency/Voltage Control 4-23
Defaults Menu 4-24
Supervisor/User Password Setting 4-25
Exit Selecting 4-26

Section 5

Driver Installation

820 and Sound Driver Installation 5-1

Section 6

PCI Audio Sound

CMI8738 Features 6-1

Section 7

Appendix

Appendix A

Memory Map A-1
I/O Map A-1
Timer & DMA Channels Map A-2
Interrupt Map A-2
RTC & CMOS RAM Map A-3

Appendix B

POST Codes A-5

Appendix C

Load Setup Defaults A-13

Appendix D

GHOST 5.1 Quick User's Guide A-15

Section 1 INTRODUCTION

Components Checklist

- ✓ A. (1) EP-6CXA2C mainboard
- ✓ B. (1) EP-6CXA2C user's manual
- ✓ C. (1) Floppy ribbon cable
- ✓ D. (1) Hard drive ribbon cables
- ✓ E. (1) Foldable Retention Module
- F. (1) Continuity Modules (optional)
- G. (1) PS/2 to AT keyboard connector adapter (optional)
- ✓ H. (1) Bus master drivers
(1) USDM

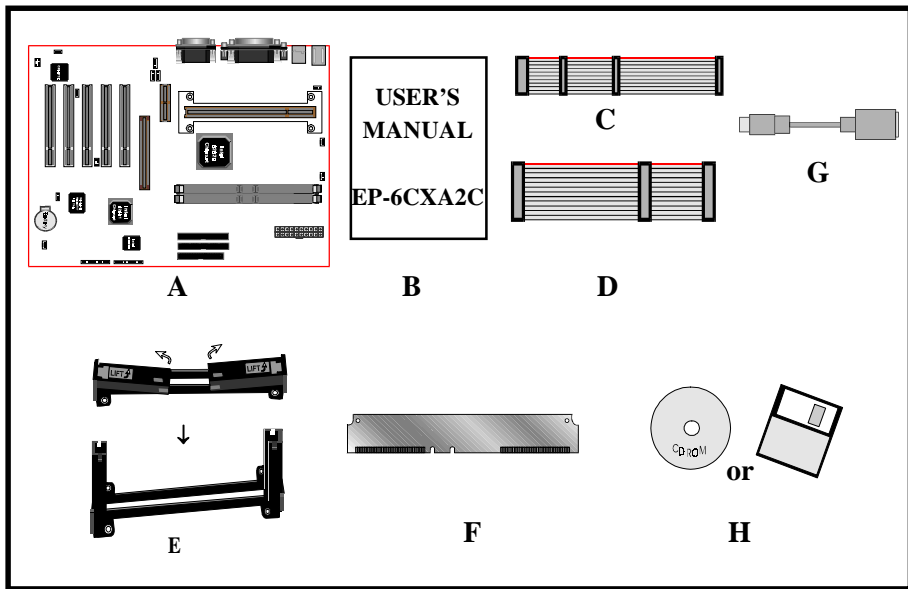

Terminology

◆ Accelerated Graphics Port (AGP)

The AGP interface that is in the MCH, it supports a subset of 3.3V, 66MHz components, 3.3V 66/133 MHz AGP 2.0 compliant components, and the new 1.5V 66/266 MHz components.

◆ CMD, SCK, SIO

CMOS side-band signals that make up the side-band bus used to communicate with the RDRAM devices without using the normal channel interface. CMD is the signal used for framing operations on SIO. SCK is the clock of the side-band bus, and SIO is the bidirectional data signal of the side-band bus.

◆ Continuity Module/C-RIMM

A RIMM module that does not have any memory devices on the module. This module serves as a pass through to propagate the Rambus channel to the next RIMM 184-pin socket.

◆ Core

The internal base logic in the MCH.

◆ Device

A single Direct RDRAM Device.

◆ DRCG

Direct Rambus Clock Generator. The DRCG provides the 300/356/400MHz channel clock for the mainboard Rambus Channel.

◆ LPC I/O

The Low Pin Count interface super I/O component.

◆ Host Bus

This term bus is used synonymously with CPU.

◆ Rambus channel

Common name referring to the high speed interface between the system memory controller MCH(820) and RDRAM devices.

◆ RDRAM

Rambus Dynamic Random - Access Memory.

◆ RIMM

Rambus Interface Memory Module.

◆ RSL

Rambus Signal Level is the name of the signaling technology used by Rambus.

◆ SC242

The connector that is the S.E.C. Cartridge 2 plugs into, just as the Pentium Pro processor used socket 8.

◆ STR (Suspend-To-RAM)

A lower power state than active. In the STR state, the system state is stored in main memory and all unnecessary system logic is turned off. Only main memory and logic required to wake the system remain powered.

System Overview

The EP-6CXA2C is designed with Intel® 820 chipset. The Intel® 820 chipset includes MCH(FW82820), ICH(FW82801) and FWH (N82802AB) three chips. The Intel® 820 chipset is the third generation desktop chipset designed for Intel's SC242 architecture and the first chipset to support the 4X capability of the AGP 2.0 Interface Specification and 400MHz Direct RDRAM. The 400MHz, 16bit, double clocked Direct RDRAM interface provides 1.6GB/s access to main memory. A new chipset component interconnect, the hub interface, is designed into the Intel® 820 chipset to provide more efficient communication between chipset components.

Support of AGP 4X, 400MHz Direct RDRAM and the hub interface provides a balanced system architecture for the Pentium® III or later SC242 architecture processor minimizing bottlenecks and increasing system performance. By increasing memory bandwidth to 1.6GB/s through the use of AGP 4X, the Intel® 820 chipset will deliver the data throughput necessary to take advantage of the high performance provided by the powerful Pentium® III or later SC242 architecture processor.

The Intel® 820 chipset architecture removes the requirement for the ISA expansion bus that was traditionally integrated into the I/O subsystem of Intel chipsets. This removes many of the conflicts experienced when installing hardware and drivers into legacy ISA systems. The elimination of ISA will provide true plug-and-play for the Intel® 820 platform.

Intel® 820 chipset contains three core components: the Memory Controller Hub (MCH), the I/O Controller Hub (ICH) and the Firmware Hub (FWH). The MCH integrates the 133MHz, Pentium® II/III processor bus controller, AGP 2.0 controller, 400MHz direct RDRAM controller and a high-speed hub interface for communication with the ICH. The ICH integrates an UltraATA/66 controller, USB host controller, LPC interface controller, FWH interface controller, PCI interface controller, and a hub interface for communication with the MCH. The Intel® 820 chipset will provide the data buffering and interface arbitration required to ensure that system interfaces operate efficiently and provide the system bandwidth necessary to obtain peak performance the Pentium® III or later SC242 architecture.

Chipset Components

The Intel® 820 chipset consists of the Memory Controller Hub (MCH), the I/O Controller Hub (ICH) and the Firmware Hub (FWH).

◆ **Memory Controller Hub (MCH)**

The MCH provides the interconnect between the Direct RDRAM and the system logic. It integrates:

- Support for single SC242 processor with 100MHz or 133MHz System Bus.
- 300MHz, 356MHz or 400MHz Direct RDRAM interface supporting 1GB of Direct RDRAM.
- 4X, 1.5V AGP interface (3.3V 1X, 2X and 1.5V 1X, 2X devices also supported).
- Downstream hub link for access to the ICH.

◆ **I/O Controller Hub (ICH)**

The I/O controller Hub provides the I/O subsystem with access to the rest of the system. Additionally, it integrates may I/O functions. The ICH integrates:

- Upstream hub link for access to the MCH
- 2 Channel Ultra ATA/66 Bus Master IDE controller
- USB controller
- SMBus controller
- FWH interface
- LPC interface
- PCI 2.2 interface
- Integrated System Management Controller

◆ **Firmware Hub (FWH)**

The FWH component is a key element to enabling a new security and manageability infrastructure for the PC platform. The device operates under the FWH interface and protocol. The hardware features of this device include a unique a Random Number Generator (RNG), register-based locking, and hardware-based locking.

Pentium® II or Pentium® III Processor

The Pentium® II or Pentium® III Processor (The Pentium® III Processor as 350~600/100MHz and 533~667/133MHz speed or above with 512K/256K-L2 cache Versions.) is the follow-on to the Pentium® Processor. The Pentium® II or Pentium® III Processor, like the Pentium® Pro processor, implements a Dynamic Execution micro-architecture -- a unique combination of multiple branch prediction, data flow analysis, and speculative execution. This enables the Pentium® II/III Processor to deliver higher performance than the Pentium® processor, while maintaining binary compatibility with all previous Intel architecture processors.

A significant feature of the Pentium® II or Pentium® III Processor, from a system perspective, is the built-in direct multiprocessing support. In order to achieve multiprocessing, and maintain the memory and I/O bandwidth to support it, new system designs are needed. For systems with dual processors, it is important to consider the additional power burdens and signal integrity issues of supporting multiple loads on a high speed bus. The Pentium® II or Pentium® III Processor card supports both uni-processor and dual processor implementations.

The Pentium® II or Pentium® III Processor utilizes Single Edge Contact (S.E.C.) (Figure 1) cartridge packaging technology. The S.E.C. cartridge allows the L2 cache to remain tightly coupled to the processor, while maintaining flexibility when implementing high performance processors into OEM systems. The second level cache is performance optimized and tested at the cartridge level. The S.E.C. cartridge utilizes surface mounted core components and a printed circuit board with an edge finger connection. The S.E.C. cartridge package introduced on the Pentium® II Processor will also be used in future Slot 1 processors.

The S.E.C. cartridge has the following features: a thermal plate, a cover and a PCB with an edge finger connection. The thermal plate allows standardized heatsink attachment or customized thermal solutions. The thermal plate enables a reusable heatsink to minimize fit issues for serviceability, upgradeability and replacement. The full enclosure also protects the surface mount components. The edge finger connection maintains socketability for system configuration. The edge finger connector is denoted as 'Slot 1 connector' in this and other documentation.

The entire enclosed product is called the Pentium® II or Pentium® III Processor. The packaging technology and each of the physical elements of the product are referred to using accurate technical descriptions. This allows clear reference to

the products as just a processor. This is the model used in past packaging technologies like PGA, TCP, PQFP, DIP, etc.

S.E.C. Cartridge Terminology

- Pentium® II or Pentium® III Processor
The new enclosed card packaging technology is called a “Single Edge Contact cartridge.” This is similar to previous names for packaging technology such as PGA or TCP.
- Processor card
The green PCB (with or without components on it)
- Processor core
The silicon on the PLGA package on the PCB
- Cover
The plastic cover on the opposite side from the thermal plate.
- Slot 1
The slot that the S.E.C. cartridge plugs into, just as the Pentium® Pro processor uses Socket 8.
- Retention mechanism
Formerly ‘retention module’ the dual posts, etc. that holds the cartridge in place.
- Thermal plate
The heatsink attachment plate.
- Heat sink supports
The support pieces that are mounted on the mainboard to provide added support for heatsinks.

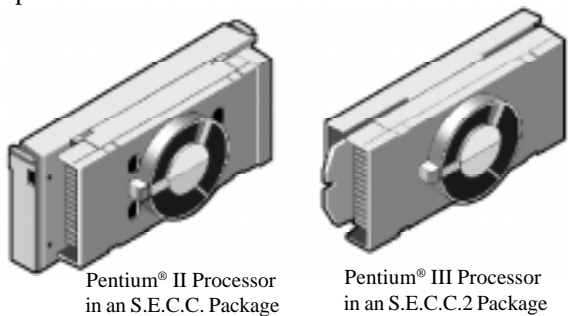

*Figure 1: Pentium® II/III Processor CPU
with S.E.C.C. or S.E.C.C.2 Package*

The L2 cache (TagRAM, PBSRAM) components keep standard industry names.

The Pentium® II or Pentium® III Processor is the first product to utilize the S.E.C. cartridge technology and Slot 1 connector. Unless otherwise noted, any references to “Pentium® II Processor,” “Pentium® II or Pentium® III Processor/Slot 1 processor” or “Pentium III Processor” will apply to both the Pentium® II Processor desktop processors.

Direct Rambus

The Direct Rambus (RDRAM) initiative will provide the memory bandwidth necessary to obtain optional performance from the Pentium III or later SC242 processor as well as a high-performance AGP graphics controller. The MCH RDRAM interface supports 300MHz, 356MHz and 400MHz operation; the latter delivers 1.6GB/s of theoretical memory bandwidth; twice the memory bandwidth of 100MHz SDRAM system. Coupled with the greater bandwidth, the RDRAM protocol, which is heavily pipelined, provides substantially more efficient data transfer. The RDRAM memory interface can achieve greater than 95% utilization of the 1.6GB/s theoretical maximum bandwidth. The Figure 2 is the example picture for RIMM Module to plug in the RIMM socket.

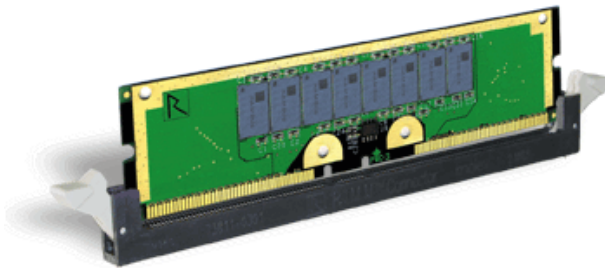

Figure 2: RIMM Module

Bandwidth Overview

Table 1 provides a summary of the bandwidth requirements for the Intel® 820 chipset.

Interface	Clock Speed (MHz)	Samples Per Clock	Data Rate (Mega-samples/s)	Data Width (Bytes)	Bandwidth (MB/s)
CPU Bus	100/133.3	1	100/133.3	8	800/1066
RDRAM	300/356/400	2	600/712/800	2	1200/1424/1600
AGP 2.0	66.6	4	266	4	1066
Hub Link	66.6	4	266	1	266
PCI 2.2	33.3	1	33.3	4	133

Table 1: Intel® 820 platform Bandwidth Summary

Accelerated Graphics Port (AGP or A.G.P.)

Typically, 3D graphics rendering requires a tremendous amount of memory, and demands ever increasing throughput speed as well. As 3D products for the personal computer become more and more popular, these demands will only increase. This will cause a rise in costs for both end users and manufacturers. Lowering these costs as well as improving performance is the primary motivation behind AGP. By providing a massive increase in the bandwidth available between the video card and the processor, it will assist in relieving some of these pressures for quite sometime.

The EP-6CXA2C provides the AGP 2.0 interface. The AGP Interface Specification revision 2.0 enhances the functionality of the original AGP Interface Specification (revision 1.0) by allowing 4X data transfers (4 data samples per clock) and 1.5 volt (power supply) operation. The AGP 2.0 interface, along with Direct Rambus memory technology, allows graphics controllers to access main memory at over 1GB/s. In order to match the 1X, 2X and 4X AGP Card. The EP-6CXA2C used the Universal AGP connector. To maximize add-in flexibility. (such as 1.5 volt for 1X, 2X and 4X or 3.3 volt for 1X and 2X AGP Card).

Ultra ATA/66

The ICH provides two channel Ultra ATA/66 Bus Master IDE controller, that support Ultra ATA/66 protocols, perfect for such demanding applications as real-time video, multimedia, and high performance operating system. A new IDE cable is required for Ultra ATA/66. This cable is an 80 conductor cable; however the connectors are, of course, backwards compatible with ATA/33.

Hardware Monitoring

Hardware monitoring allows you to monitor various aspects of your systems operations and status. The features include CPU temperature, voltage and RPM of fan.

EP-6CXA2C Form-Factor

The EP-6CXA2C is designed with ATX form factor - the latest industry standard of chassis. The ATX form factor is essentially a Baby-AT baseboard rotated 90 degrees within the chassis enclosure and a new mounting configuration for the power supply. With these changes the processor is relocated away from the expansion slots, allowing them all to hold full length add-in cards. ATX defines a double height aperture to the rear of the chassis which can be used to host a wide range of onboard I/O. Only the size and position of this aperture is defined, allowing PC manufacturers to add new I/O features (e.g.; TV input, TV output, joystick, modem, LAN, audio, etc.) to systems. This will help systems integrators differentiate their products in the marketplace, and better meet your needs.

- By integrating more I/O down onto the board and better positioning the hard drive and floppy connectors material cost of cables and add-in cards is reduced.
- By reducing the number of cables and components in the system, manufacturing time and inventory holding costs are reduced and reliability will increase.
- By using an optimized power supply, it's possible to reduce cooling costs and lower acoustical noise. An ATX power supply, which has a side-mounted fan, allows direct cooling of the processor and add-in cards making a secondary fan or active heatsink unnecessary in most system applications.

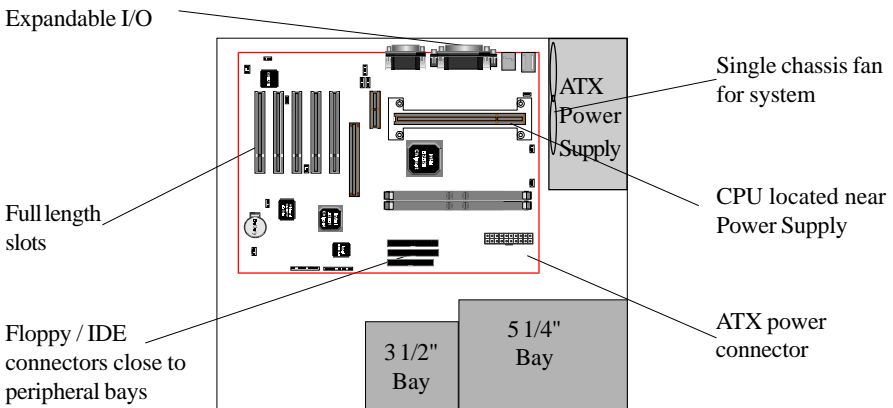

Figure 3: Summary of ATX chassis features

I/O Shield Connector

The EP-6CXA2C is equipped with an I/O back panel. Please use the appropriate I/O shield (figure 4).

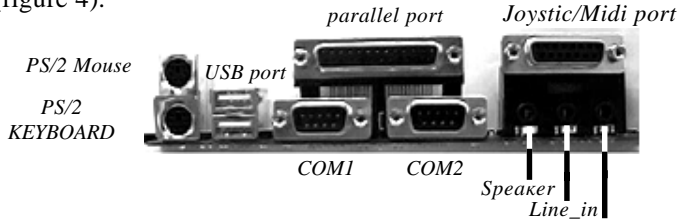

Figure 4: I/O back panel layout

Power-On/Off (Remote)

The EP-6CXA2C has a single 20-pin connector for ATX power supplies. For ATX power supplies that support the **Remote On/Off** feature, this should be connected to the systems front panel for system Power On/Off button. The systems power On/Off button should be a momentary button that is normally open.

The EP-6CXA2C has been designed with "Soft Off" functions. You can turn Off the system from one of two sources: The first is the front panel Power On/Off button, and the other is the "Soft Off" function (coming from the EP-6CXA2's onboard circuit controller) that can be controlled by the operating system. Windows 95/98 will control this when the user clicks that they are ready to Shutdown the system.

Note: For maintaining the RDRAM power during STR (ACPI S3) function, it is strongly recommend to use ATX power supplies that have a +5VSB current of (\geq) 1A (1000mA). Please check the 5VSB's specification that has been printed on the ATX power supply's outer case.

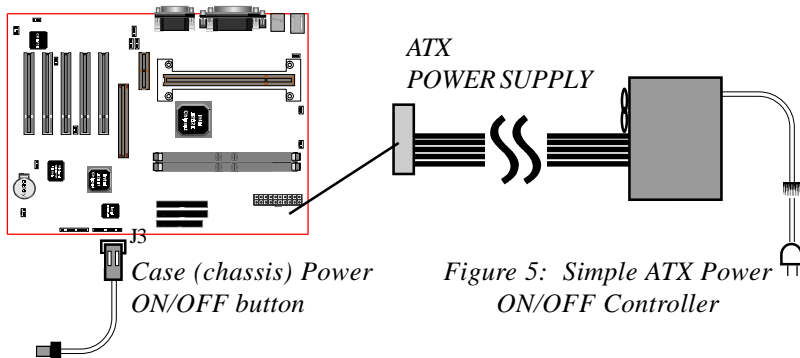

Figure 5: Simple ATX Power ON/OFF Controller

System Block Diagram

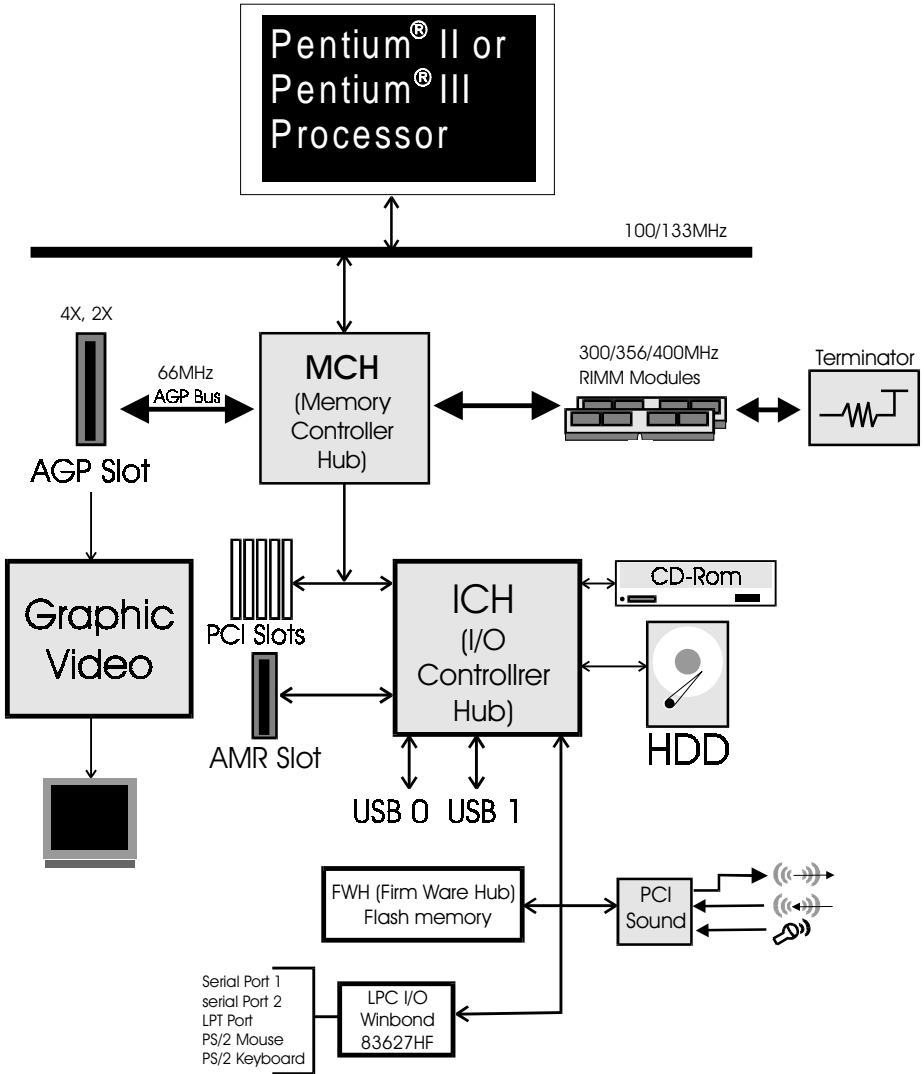

Figure 6: System Block Diagram

Page Left Blank

Section 2

FEATURES

EP-6CXA2C Features:

- EP-6CXA2C is based on the Pentium® II or Pentium® III Processor operating at 350 ~ 667MHz (100/133MHz) on Slot 1. The board is configured by a BIOS setting to match your CPU and Direct RDRAM clock speed.
- Designed with Intel's 820 Chipset.
- Supports up to 1GB of Direct RDRAM (minimum of 64 MB) on board, You can use 184-pin RIMM x 2 or use continuity module (C-RIMM) and RIMM module to plug in the RIMM socket (please see Section 3-2).
- EP-6CXA2C will support Non-ECC or ECC (Error Checking and Correction). In ECC mode of operation, all RDRAMs in the system must have a byte width of 9 bit. The MCH provides auto-correction of the data read from memory. Non-ECC or ECC configuration options are set by the BIOS setup.
- Supports Universal AGP connector for 1X, 2X or 4X AGP Card.
- Supports (5) 32 bit PCI slots, (1) AGP slot and provides (2) independent high performance PCI IDE interfaces capable of supporting PIO Mode 3/4 and Ultra DMA 33/66 devices. The EP-6CXA2C supports (5) PCI Bus Master slots and a jumperless PCI INT# control scheme which reduces configuration confusion when plugging in PCI card(s).
- Supports ATAPI (e.g. CD-ROM) devices on both Primary and Secondary IDE interfaces.
- Designed with Winbond W83627HF LPC I/O: (1) floppy port, (1) parallel port (EPP, ECP), and (2) serial ports (16550 Fast UART).
Note: Japanese "Floppy 3 mode" is also supported
- Advanced Configuration Power Interface (ACPI) Ready.
- Y2K Compliant.
- Features Award Plug & Play BIOS. With Flash Memory you can always upgrade to the current BIOS as they are released. (<http://www.epox.com> please visit our Technical Support section for the latest updates).

- EP-6CXA2C utilizes a Lithium battery which provides environmental protection and longer battery life.
- Supports the Universal Serial Bus (USB) connector. The onboard ICH chip provides the means for connecting PC peripherals such as; keyboards, joysticks, telephones, and modems.
- Built-in ATX 20-pin power supply connector.
- Software power-down when using Windows® 95/98.
- Supports ring-in feature (remote power-on through external modem, allows system to be turned on remotely).
- Resume by Alarm - Allows your system to turn on at a preselected time.
- Supports CPU Hardware sleep and SMM (System Management Mode).
- Supports Hot key, Any key or password Keyboard power ON function (KBPO).
- Supports USDM software to offer motherboard various status on Windows® 95/98.
- Supports the CPU, PWR and Chassis fan Auto stop in sleep mode.
- Supports the onboard standby and blinks in suspend green or STR mode LED (D11).
- Supports the STR (Suspend To RDRAM) power management by ACPI's S3.
- Supports the STR indicator red LED (D17) to avoid plugging or un-plugging RIMM modules when in a STR mode.
- Supports the System Power LED (PANEL) blinking in the sleep mode.
- Built-in WOL (Wake On Lan) Connector.
- Supports an AMR Connector for use with a software AMR modem card. (AMR card is Primary only).
- Built-in C-Media CMI8738 PCI Sound Onboard.
- True Full Duplex playback and recording, built-in 16 bits CODEC.
- HRTF 3D positional audio, supports both Direct Sound 3D® & A3D® interface, two and four channel speaker mode.
- Supports OPL3, MPU401 UART mode and Joystick function.
- Downloadable Wave Table Synthesizer, supports Direct Music®.
- Supports Digital Audio (SPDIF IN/OUT) module (Optional).

Section 3
INSTALLATION

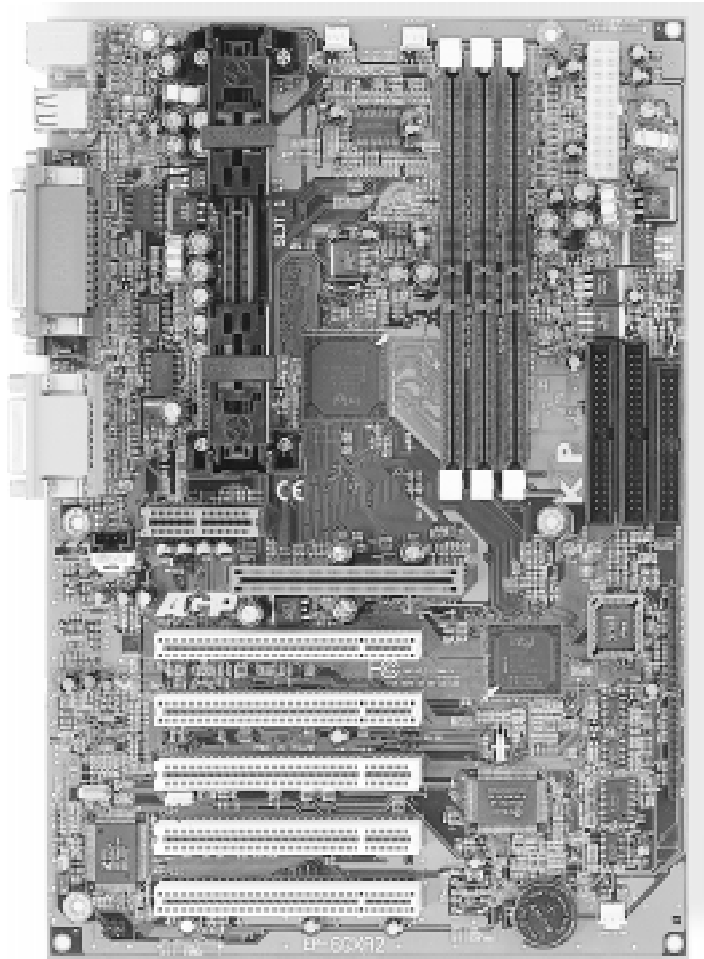

EP-6CXA2C Detailed Layout

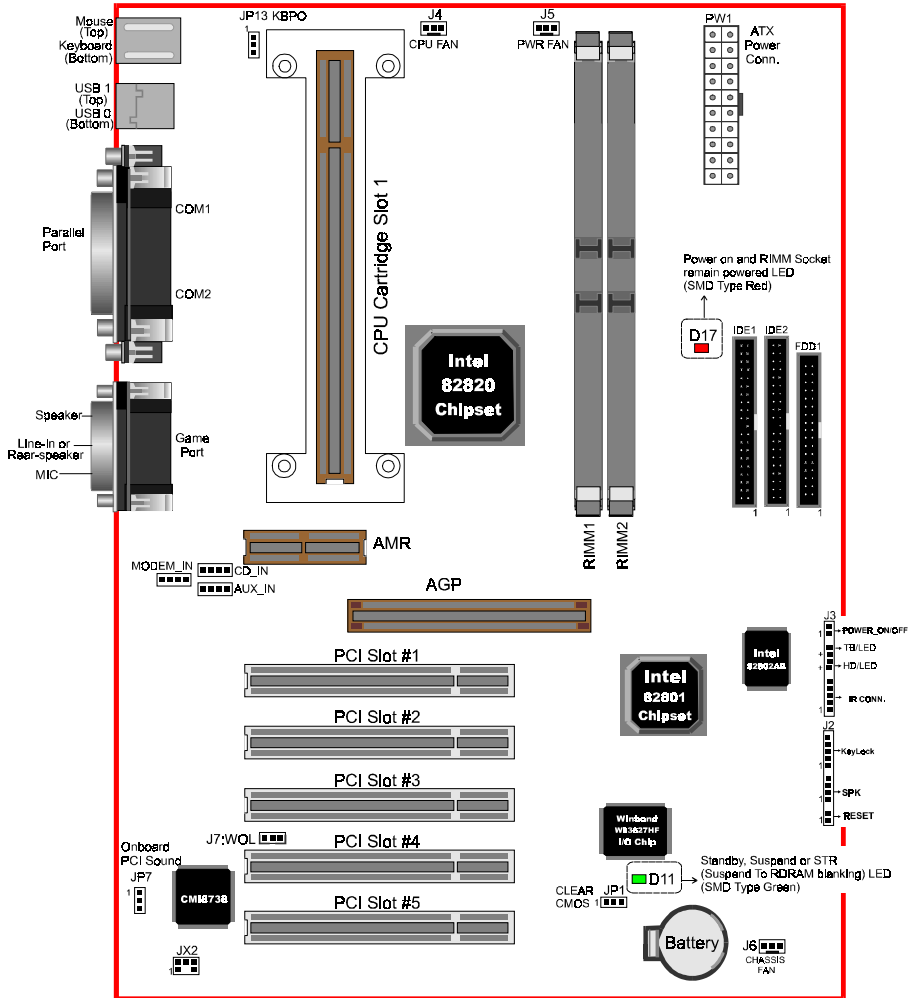

Figure 7

Easy Installation Procedure

Easy Installation Procedure





The following must be completed before powering on your new system:

- 3-1. **Configure Jumpers**
- 3-2. **System RIMM Memory Module Configuration**
- 3-3. **Install Pentium® II/III Processor**
- 3-4. **Device Connectors**
- 3-5. **External Modem Ring-in Power ON and Keyboard Power ON Function (KBPO)**
- 3-6. **STR (Suspend To RAM) Function**

Section 3-1 Configure Jumpers

We have designed this mainboard with the fewest jumpers as possible to make your installation fast and easy.

The following will describe all of the jumpers that you are required to set.

- | | |
|---|---|
| <p>JP1</p>  | <p>CMOS Clear</p> <p>JP1 = 1-2 - Run Mode (Default)
= 2-3 - Clear CMOS (momentarily)</p> |
| <p>JP7</p>  | <p>On Board PCI Sound</p> <p>JP7 = 1-2 - Enabled PCI Sound (Default)
= 2-3 - Disabled PCI Sound</p> |
| <p>JP13</p>  | <p>Keyboard Power-ON function (refer the section 3-5)</p> <p>JP13 = 1-2 - Enabled
= 2-3 - Disabled(Default)</p> |
| <p>J7</p>  | <p>WOL (Wakup On Lan) Connector
Reserved for NIC (Network Interface Card) to
Wake the System.</p> |

CPU & RDRAM Selection					
* FSB (Host Clock)	100MHz		133MHz		
RDRAM	300	400	266	356	400
* Bus Clock	(PC600)	(PC800)	(PC533)	(PC711)	(PC800)

* The FSB clock and RDRAM bus clock are set using the “Frequency/Voltage Control” option in the CMOS SETUP UTILITY menu.

The mainboard is designed to set the CPU Host/AGP/PCI and RDRAM Bus Clock at jumper-free. Based on the implementation of Intel 820 chipset, EP-6CXA2C is able to provides two host bus frequencies--either 100 or 133MHz for PII/III slot1 processors. The RDRAM interface supports 300/400MHz (100MHz FSB) or 266/356/400MHz (133MHz FSB) operation. The CPU Host/AGP/PCI clock and RDRAM Bus Frequency are selected using the “Frequency/Voltage Control” option in the CMOS SETUP Utility menu. Check your CPU, RDRAM and set this frequency accordingly.

Note: For CPU/AGP/PCI and RDRAM over-clocking requirement which can chosen and set by BIOS, it is advised that over-clocking use these only for testing since this is not stable as the CPU/AGP/PCI/RDRAM is not designed for these over-clocking frequencies.

The RDRAM Bus memory timing is difference with SDRAM. If you set the RDRAM Bus Frequency to be too high, then the system will not turn on again (no display). You can clear CMOS by shorting JP1’s 2-3 pin (momentarily), while the system is off. The system will be turn on by the CMOS default value.

Section 3-2 System RIMM Memory Module Configuration

Memory Layout

The EP-6CXA2C supports (2) 184-pin RIMMs (Rambus Interface Memory Module) as shown in Figure 9. The RIMMs can be RIMM and C-RIMM (Continuity RIMM) only. RIMM modules have Rambus channel signals as their memory interface. A RIMM module may contain up to a maximum of 16 RDRAM devices. All RDRAM devices on a RIMM must have the same timing characteristics. Empty RIMM sockets must be populated with continuity modules (C-RIMM). These modules have no memory on them and are used to propagate the channel to the next RIMM socket. Figure 11, 12, 13 & 14 provide a general diagram of a RIMM module and installations of RIMM/C-RIMM modules.

- The EP-6CXA2C supports a maximum of 32 devices on a RDRAM channel A Channel as defined as the three RIMM Slots on the motherboard added together. Thus the motherboard has one channel. See Figure 10 for RDRAM interconnections.
- No support for EDO/SDRAM DIMM Modules.
- The EP-6CXA2C supports 16/18 (ECC) - bit RDRAM configurations.
- The RIMM modules and continuity RIMM (C-RIMM) spec. should be Revision Number 1.0. For more detailed “RIMM Modules spec.” information you may visit the following Web Site: <http://www.rimm.com>.
- 64MB, 128MB or 256MB DRAM technology that supports 256MB, 512MB, 1GB (in the feature devices) max. memory size module produced. The Max. memory information show in Table 2.
- Direct Rambus Channel operating at a clock rate of 300/356/400MHz which enables a data rate of 600/711/800MHz (data is clocked on both clock edges).

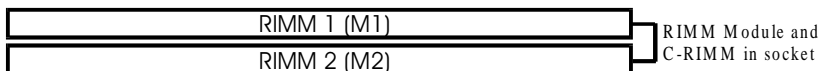

Figure 9

RDRAM technology	Max Memory on Channel
64 Mbit	256 MB
128 Mbit	512 MB
256 Mbit	1 GB

Table 2: Maximum memory support on EP-6CXA2C with RDRAM populated on a channel.

The figure 10 below shows the RSL interconnections between 820 (MCH) and one RDRAM channel. This figure describes the logical interconnections, and is not a physical representation of RDARM devices on a motherboard.

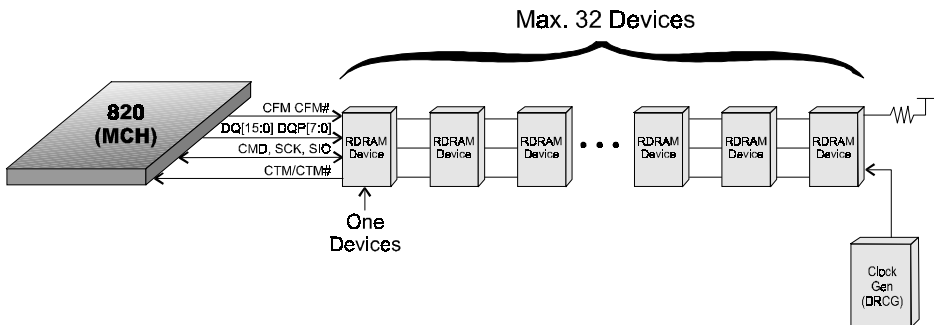

Figure 10: MCH/RDRAM Interconnections

The table 3 below shows the onboard RIMM memory socket population.

RIMM Socket# of Onboard		System Accept	Max. of RDRAM devices on a mainboard	Total Memory
RIMM1	RIMM2	Status	Device	Size
RIMM#	C-RIMM%	OK	16	512MB *
RIMM#	RIMM#	OK	32	1024MB (1GB) *
Any RIMM socket# is empty or the RIMM Module is not properly inserted.		Failure, System can't boot and no display.		

Table 3: Onboard RIMM memory socket population.

RIMM# : RIMM in Socket

C-RIMM% : Continuity Module in Socket

* : That will be to supporting in the feature devices

RIMM/C-RIMM Module Installation

This section describes some basic RIMM/C-RIMM installations as described in table 3. Note that continuity Modules are required in empty sockets. Figure 11, 12 and 13 display common installations including an example of a incorrect one (see figure 11). RIMM or RDRAM signals are daisy-chained through each device on RIMM and memory module.

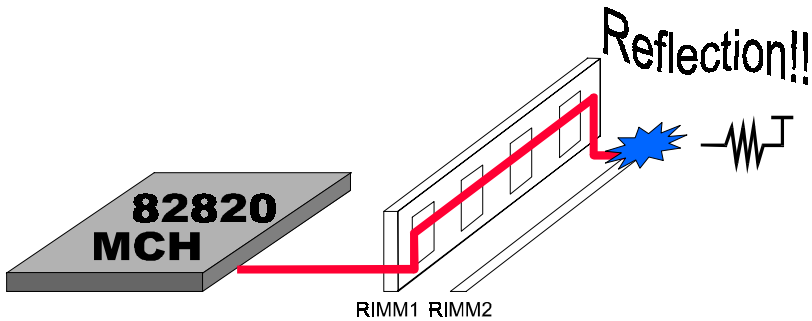

Figure 11: Wrong Configuration

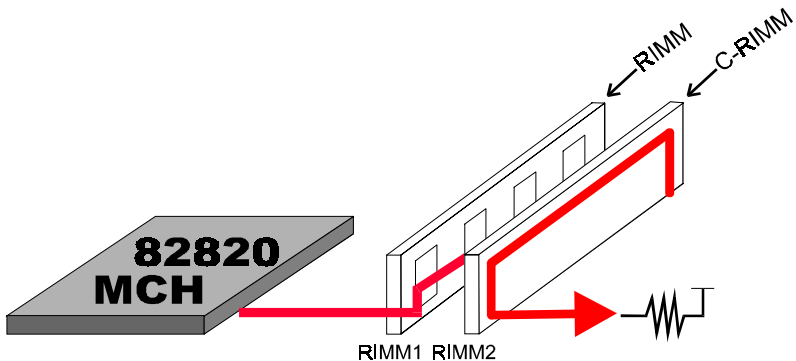

Figure 12: Base Configuration

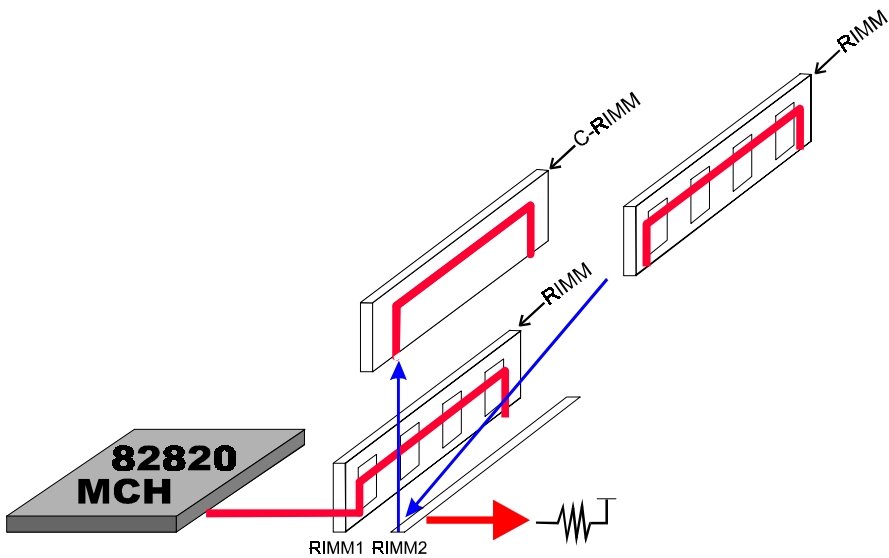

Figure 13: Upgrade Configuration

Figure 15 displays the notch marks and what they should look like on your RIMM memory module.

RIMMs have 184-pins and two notches that will match with the onboard RIMM socket. RIMM modules are installed by placing the chip firmly into the socket at a 90 degree angle and pressing straight down (figure 16) until it fits tightly into the RIMM socket (figure 17).



Figure 15

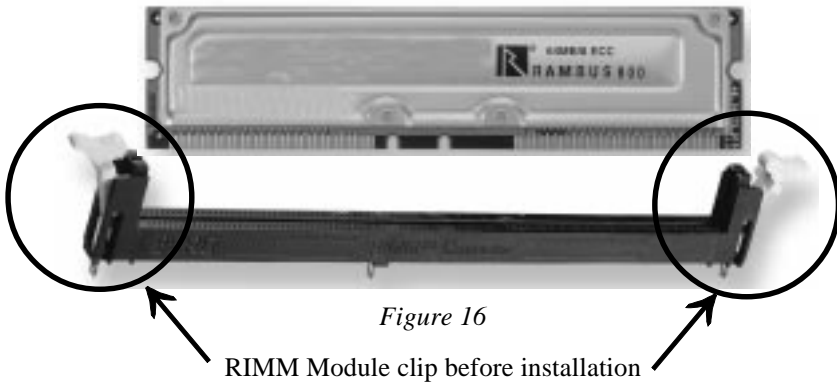

Figure 16

RIMM Module clip before installation

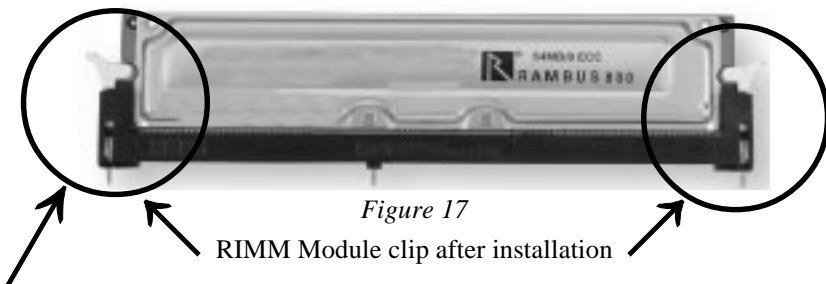

Figure 17

RIMM Module clip after installation

To remove the RIMM module simply press down both of the white clips on either side and the module will be released from the socket.

Figure 15a displays the notch marks and what they should look like on your C-RIMM memory module.

C-RIMMs have 184-pins and two notches that will match with the onboard C-RIMM socket. C-RIMM modules are installed by placing the chip firmly into the socket at a 90 degree angle and pressing straight down (figure 16a) until it fits tightly into the RIMM socket (figure 17a).



Figure 15a

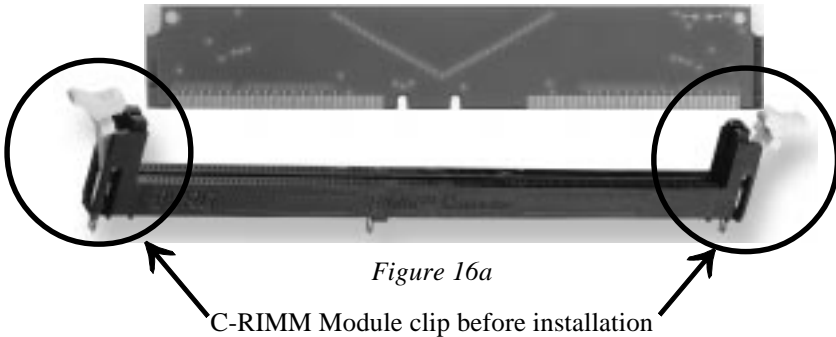

Figure 16a

C-RIMM Module clip before installation

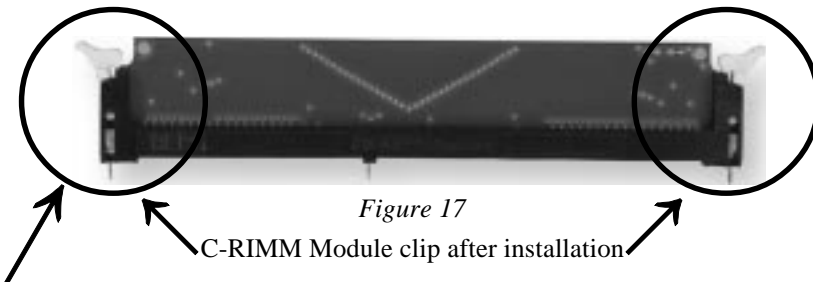

Figure 17

C-RIMM Module clip after installation

To remove the C-RIMM module simply press down both of the white clips on either side and the module will be released from the socket.

Section 3-3

Installing a Pentium® II/III Processor

The EP-6CXA2C uses the Single Edge Contact (SEC) slot for a Pentium® II/III processor packaged in an SEC cartridge. The SEC slot is not compatible with other non-Pentium® II/III processors.

Please have ready the following list of components so that we may install the processor onto the motherboard.

1. Pentium® II/III processor heat sink
2. Intel Pentium® II/III Processor

OK, now that you have all of your components ready, we can start.

- ❶ First, please refer to figure 18 below, and follow the direction to lift up the fixed foldable pentium® II/III Retention Mechanism. This pre-installed device is designed for you to install Pentium® II/III CPU more easier and to avoid any damage on the board due to overtightening the four screws.
- ❷ One thing must be kept in your mind that please make sure to lift upright the foldable parts of the Retention module to fit and install CPU properly.

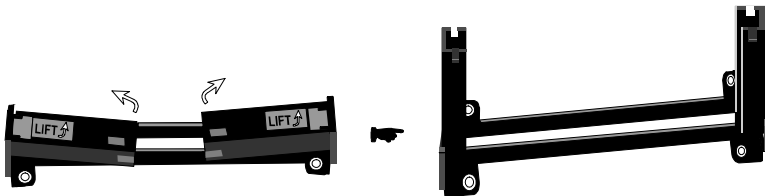

Figure 18

Now we are going to put the heatsink or cooler onto Pentium® II/III processor. Due to the processor faster and more powerful features. The power consumption is larger than past processor. We strongly recommend a good attached fan/heatsink or cooler onto the processor's OLGA package.

The Pentium® II/III processor may also be offered as Intel® boxed processors. The boxed processor's fan heatsink requires a +12V power supply. A fan power cable

will be shipped with the boxed processor to draw power from a power header on the mainboard's J4.

Now we are ready to install the SEC Cartridge (Pentium II/III Processor) into the Retention Module. The SEC Cartridge is mounted by sliding the SEC Cartridge into the Retention Module and letting it slide all the way down. Once it reaches the bottom make sure you press firmly on SEC cartridge to firmly secure into the Slot 1 Socket.

Section 3-4

Device Connectors

Please install the motherboard into the chassis.

Now that your motherboard is installed you are ready to connect all your connections (figure 19).

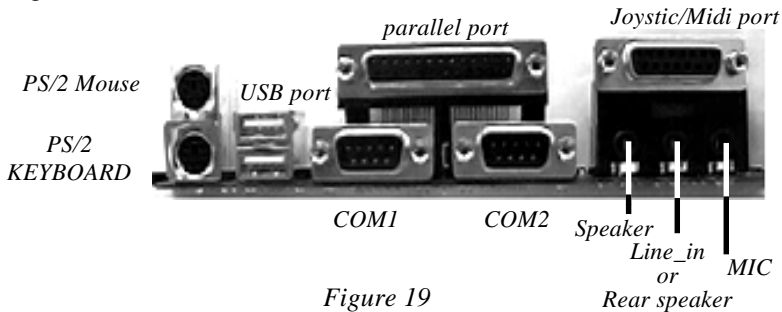

Figure 19

- J2,J3:** Chassis Panel Connector
- Power LED, Keylock, Speaker, Reset, Sleep, Turbo LED and HDD LED
- J4:** CPU Fan Power
- A plug-in for the CPU Fan Power
- J5:** Power Supply Fan Monitoring
- A plug-in for the Power supply so that BIOS can monitor the RPM's
- J6:** Chassis Fan Power
- A plug-in for the chassis Fan Power
- J7:** WOL (Wake On Lan) Connector
- PW1:** ATX Power Connector
- 20-pin power connector
- IDE1:** Primary IDE Connector
- IDE2:** Secondary IDE Connector
- FDD1:** Floppy Controller Connector
- CD-IN:** CD Audio_IN Connector
- Pin1(CD_IN_Left), Pin2/Pin3(GND), Pin4(CD_IN_Right)
- AUX_IN:** Auxiliary Line_IN Connector
- Pin1(Left Line_IN), Pin2/Pin3(GND), Pin4(Right Line-IN)
- MODEM_IN:** Telephony Connector
- Pin1(Audio_in), Pin2/Pin3(GND), Pin4(Mic-out to Modem)
- JX2:** OPTICAL SPDIF-I/O

Device Connectors (continued)

Power On/Off

(This is connected to the power button on the case. Using the Soft-Off by Pwr-BTTN feature, you can choose either Instant Off (turns system off immediatly), or 4 sec delay (you need to hold the button down for 4 seconds before the system turns off). When the system is in 4 sec delay mode, there is a special feature to make the system to go into suspend mode when the button is pressed momentarily.)

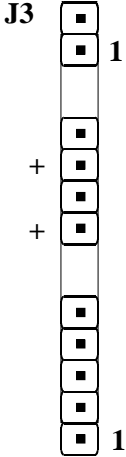

Turbo LED indicator - LED ON when higher speed is selected

IDE LED indicator - LED ON when Onboard PCI IDE Hard disks is activate

IR Connector

- | | |
|---------|---------|
| 1. VCC | 4. GND |
| 2. NC | 5. IRTX |
| 3. IRRX | |

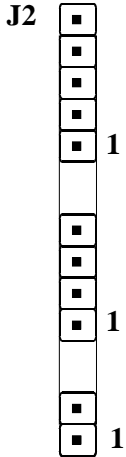

KeyLock - Keyboard lock switch & Power LED connector

- | | |
|-----------------|---|
| 1. Power LED(+) | 4. KeyLock |
| 2. N/C | 5. GND |
| 3. GND | * The power LED lights when the system is powered on and blinks in SLEEP MODE (Suspend mode). |

Speaker - Connect to the system's speaker for beeping

- | | |
|------------|--------|
| 1. Speaker | 3. GND |
| 2. N/C | 4. GND |

Reset - Closed to restart system.

Device Connectors (continued)

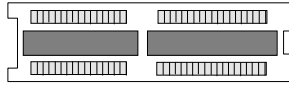

AMR1 Connector

The EP-6CXA2C supports one AMR1 connector to provide a Modem Code (MC) or an Audio/Modem Codec (AMC) configuration. Note the AMR1 connector supports Modem Riser Card (MR), Modem Code (MC) or Audio/Modem Code (AMC) as primary only.

Section 3-5

External Modem Ring-in Power ON and Keyboard Power ON Functions (KBPO)

On the basis of bounded functions in I/O chipset, the two serial ports are able to support the External Modem Ring-in Power ON function. Once users connect the external modem to COM1 or COM2, the EP-6CXA2C mainboard allows users to turn on their system through the remote and host's dial-up control.

Exclusive Keyboard Power ON Function

To innovate a unique feature to benefit users, we devoted the easiest and most convenient way to turn on your system based on the the ATX power supply.

How to work with it

Step 1: Please check that JP13 is at position 1-2 after you finished the system installation.

JP13  1 *Keyboard Power-ON Function Selection*
 1-2 : Enabled
 3 2-3 : Disabled (Default)

Step 2: Push the momentary switch (J3 PW-ON) to turn on your system and then push again and hold for more than 4 seconds to turn it off after counting memory.

Step 3: You can enjoy the Keyboard Power ON function (KBPO) by *pressing any 1 key, Hot key (Ctrl-F1, F2.....F12), Password (A maximum of 5 characters can be entered.) and BUTTON only to turn on your system. Please refer to the BIOS Integrated peripherals setup for detail (Page 4-23).The BIOS Default is keyboard Hot key <Ctrl> - <F1> to turn on the system. Your system will be turned on automatically, after releasing the keys. To power off you system, you can use the Soft-OFF function under Windows 95.*

Notes:

1. Intel ATX version 2.01 specification has recommended you use the power supply with 1.0A in 5.0VSB. With our EP-6CXA2C mainboard, *the 5.0VSB standby power only has to be > = 1A (1000mA)* then you can enjoy this function.

3-6 STR (Suspend To RAM) Function

The EP-6CXA2C supports the STR power management state by maintaining the appropriate states on the RDRAM interface signals. The power source must be kept alive to the RDRAM during STR (ACPI S3). Advanced Configuration Power Interface (ACPI) provides more Energy Saving Features for operating systems that support OS such as ON and QuickStart™ function.

1. To enable the ACPI function and use the STR functionally to save your system energy, you are recommended to confirm the following requirements:
 - a. Please make sure the VGA card in your system is ACPI fully supported. Some VGA cards or drivers do not provide ACPI function. It is suggested you contact with VGA card vendors to get the right information and technical support.
 - b. In BIOS, please select “ACPI function: Enable” and “ACPI Suspend Type: S3(STR)” in the Power Management Setup menu.
 - c. Then, please type the following before installing the Windows® 98:

{Drive}:> Setup /p j

If Windows® 98 was installed in your system without the parameters above, please do refer to your software manual or contact Microsoft for more details on how to upgrade to ACPI support.

- d. Restart your system and install VGA card driver properly.
 - e. Go in to the “Advanced” section of the Power Management icon of Control Panel, and select “Stand By” in the Power Buttons.
2. To start the STR mode, please click the START button and choose Shut Down icon. Then, select the Stand By option in the Shut Down Windows box to let system go to STR mode. In the mean time, the onboard STR indicator - Green LED(D11 position) begins to blinking to show your system is under STR mode. Here are the differences between STR power saving mode and Green (or Suspend) mode:
 - a. It is the most advanced Power Management mode
 - b. It cuts all the power supplied to peripherals except to Memory - max. power saving

- c. It saves and keeps all on-screen data including any executed applications to RDRAM.
- d. You must push the Power button connected with onboard J3 pin to wake up you system (not to click to mouse or press keyboard to wake up the system.)

Just pushing Power button, your system will quickly back to the last screen for you.

The “LED Indicator for ACPI Status” table shown below will guide you and give you a reference for ACPI status on this mainboard.

ACPI Onboard's LED Status Indicator Table					
Onboard's LED Location	Status				
	Plug in the ATX Power Core	Power ON J3(PW-ON)	Green Mode (S1)	STR (S3)	Shutdown (Soft-OFF) (S5)
D11 (Green LED)	ON	ON	Blanking	Blanking	ON
D17 (Red LED)	ON	ON	ON	ON	OFF
J2 PW_LED	OFF	ON	Blanking	OFF	OFF

Page Left Blank

Section 4

BIOS SETUP

Main Menu

Once you enter the AwardBIOS™ CMOS Setup Utility, the Main Menu will appear on the screen. The Main Menu allows you to select from several setup functions and two exit choices. Use the arrow keys to select among the items and press <Enter> to accept and enter the sub-menu.

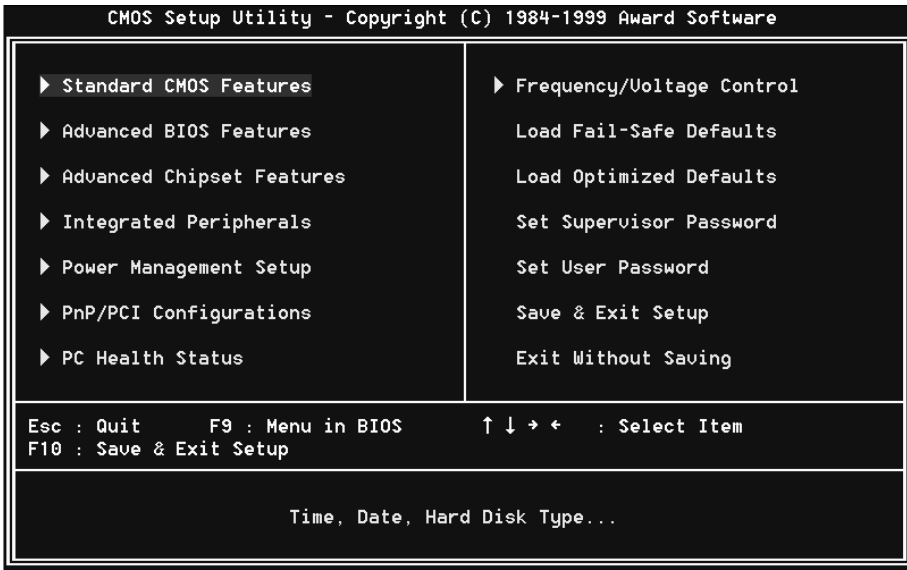

Note that a brief description of each highlighted selection appears at the bottom of the screen.

Setup Items

The main menu includes the following main setup categories. Recall that some systems may not include all entries.

Standard CMOS Features

Use this menu for basic system configuration.

Advanced BIOS Features

Use this menu to set the Advanced Features available on your system.

Advanced Chipset Features

Use this menu to change the values in the chipset registers and optimize your system's performance.

Integrated Peripherals

Use this menu to specify your settings for integrated peripherals.

Power Management Setup

Use this menu to specify your settings for power management.

PnP / PCI Configuration

This entry appears if your system supports PnP / PCI.

PC Health Status

This item is only show the system health status (include Voltage, Fan speed, CPU temperature...)

Frequency/Voltage Control

Use this menu to specify your settings for frequency/voltage control.

Load Fail-Safe Defaults

Use this menu to load the BIOS default values for the minimal/stable performance for your system to operate.

Load Optimized Defaults

Use this menu to load the BIOS default values that are factory settings for optimal performance system operations. While Award has designed the custom BIOS to maximize performance, the factory has the right to change these defaults to meet their needs.

Supervisor / User Password

Use this menu to set User and Supervisor Passwords.

Save & Exit Setup

Save CMOS value changes to CMOS and exit setup.

Exit Without Save

Abandon all CMOS value changes and exit setup.

4-1 Standard CMOS Setup

The items in Standard CMOS Setup Menu are divided into 10 categories. Each category includes no, one or more than one setup items. Use the arrow keys to highlight the item and then use the <PgUp> or <PgDn> keys to select the value you want in each item.

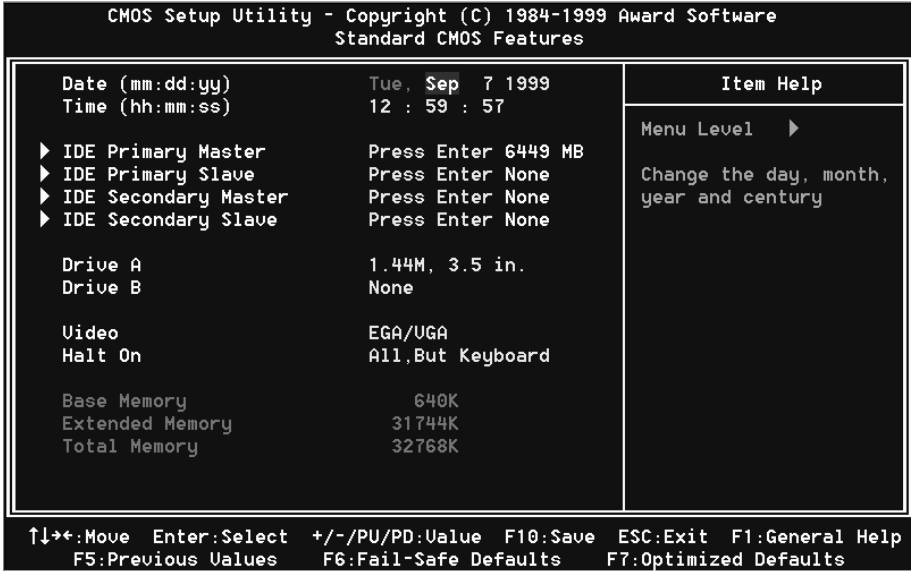

Figure 1: The Main Menu

Main Menu Selections

This table shows the selections that you can make on the Main Menu

<i>Item</i>	<i>Options</i>	<i>Description</i>
Date	Month DD YYYY	Set the system date. Note that the 'Day' automatically changes when you set the date
Time	HH : MM : SS	Set the system time
IDE Primary Master	Options are in its sub menu (described in Table 3)	Press <Enter> to enter the sub menu of detailed options
IDE Primary Slave	Options are in its sub menu (described in Table 3)	Press <Enter> to enter the sub menu of detailed options
IDE Secondary Master	Options are in its sub menu (described in Table 3)	Press <Enter> to enter the sub menu of detailed options
IDE Secondary Master	Options are in its sub menu (described in Table 3)	Press <Enter> to enter the sub menu of detailed options
Drive A Drive B	None 360K, 5.25 in 1.2M, 5.25 in 720K, 3.5 in 1.44M, 3.5 in 2.88M, 3.5 in	Select the type of floppy disk drive installed in your system
Video	EGA/VGA CGA 40 CGA 80 MONO	Select the default video device
Halt On	All Errors No Errors All, but Keyboard All, but Diskette All, but Disk/Key	Select the situation in which you want the BIOS to stop the POST process and notify you
Base Memory	N/A	Displays the amount of conventional memory detected during boot up
Extended Memory	N/A	Displays the amount of extended memory detected during boot up
Total Memory	N/A	Displays the total memory available in the system

Table 2 Main Menu Selections

IDE Adapters

The IDE adapters control the hard disk drive. Use a separate sub menu to configure each hard disk drive.

Figure 2 shows the IDE primary master sub menu.

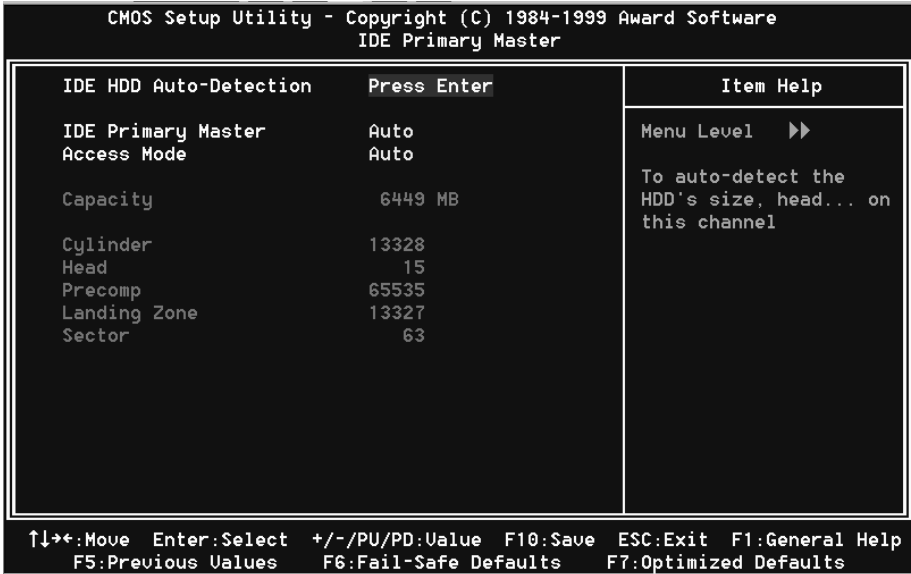

Figure 2 IDE Primary Master sub menu

Use the legend keys to navigate through this menu and exit to the main menu. Use Table 3 to configure the hard disk.

<i>Item</i>	<i>Options</i>	<i>Description</i>
IIDE HDD Auto-detection	Press Enter	Press Enter to auto-detect the HDD on this channel. If detection is successful, it fills the remaining fields on this menu.
IDE Primary Master	None Auto Manual	Selecting 'manual' lets you set the remaining fields on this screen. Selects the type of fixed disk. "User Type" will let you select the number of cylinders, heads, etc. Note: PRECOMP=65535 means NONE !
Capacity	Auto Display your disk drive size	Disk drive capacity (Approximated). Note that this size is usually slightly greater than the size of a formatted disk given by a disk checking program.
Access Mode	Normal LBA Large Auto	Choose the access mode for this hard disk
The following options are selectable only if the 'IDE Primary Master' item is set to 'Manual'		
Cylinder	Min = 0 Max = 65535	Set the number of cylinders for this hard disk.
Head	Min = 0 Max = 255	Set the number of read/write heads
Precomp	Min = 0 Max = 65535	**** Warning: Setting a value of 65535 means no hard disk
Landing zone	Min = 0 Max = 65535	****
Sector	Min = 0 Max = 255	Number of sectors per track

Table 1 Hard disk selections

4-2 Advanced BIOS Features

This section allows you to configure your system for basic operation. You have the opportunity to select the system’s default speed, boot-up sequence, keyboard operation, shadowing and security.

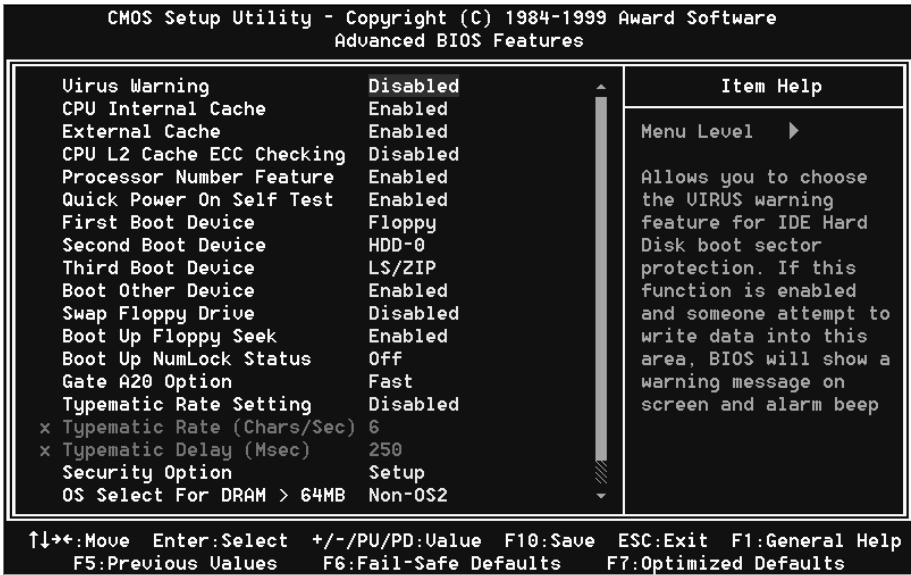

Virus Warning

Allows you to choose the VIRUS Warning feature for IDE Hard Disk boot sector protection. If this function is enabled and someone attempt to write data into this area, BIOS will show a warning message on screen and alarm beep.

Enabled: Activates automatically when the system boots up causing a warning message to appear when anything attempts to access the boot sector or hard disk partition table.

Disabled: No warning message will appear when anything attempts to access the boot sector or hard disk partition table.

CPU Internal Cache/External Cache

These two categories speed up memory access. However, it depends on CPU/chipset design.

Enabled: Enable cache

Disabled: Disable cache

CPU L2 Cache ECC Checking

This item allows you to enable/disable CPU L2 Cache ECC checking.

The choice: Enabled, Disabled.

Processor Number Feature

Pentium III or later CPU new feature. The default is Enabled.

Enabled: Processor serial number readable.

Disabled: Processor serial number disabled.

Quick Power On Self Test

This category speeds up Power On Self Test (POST) after you power up the computer. If it is set to Enable, BIOS will shorten or skip some check items during POST.

Enabled: Enable quick POST

Disabled: Normal POST

First/Second/Third/Other Boot Device

The BIOS attempts to load the operating system from the devices in the sequence selected in these items.

The Choice: Floppy, LS/ZIP, HDD, SCSI, CDROM, Disabled.

Swap Floppy Drive

If the system has two floppy drives, you can swap the logical drive name assignments.

The choice: Enabled/Disabled.

Boot Up Floppy Seek

Seeks disk drives during boot up. Disabling speeds boot up.

The choice: Enabled/Disabled.

Boot Up NumLock Status

Select power on state for NumLock.

The choice: Enabled/Disabled.

Gate A20 Option

Select if chipset or keyboard controller should control GateA20.

Normal: A pin in the keyboard controller controls GateA20

Fast: Lets chipset control GateA20

Typematic Rate Setting

Key strokes repeat at a rate determined by the keyboard controller. When enabled, the typematic rate and typematic delay can be selected.

The choice: Enabled/Disabled.

Typematic Rate (Chars/Sec)

Sets the number of times a second to repeat a key stroke when you hold the key down.

The choice: 6, 8, 10, 12, 15, 20, 24, 30.

Typematic Delay (Msec)

Sets the delay time after the key is held down before it begins to repeat the keystroke.

The choice: 250, 500, 750, 1000.

Security Option

Select whether the password is required every time the system boots or only when you enter setup.

System The system will not boot and access to Setup will be denied if the correct password is not entered at the prompt.

Setup The system will boot, but access to Setup will be denied if the correct password is not entered at the prompt.

Note: To disable security, select PASSWORD SETTING at Main Menu and then you will be asked to enter password. Do not type anything and just press <Enter>, it will disable security. Once the security is disabled, the system will boot and you can enter Setup freely.

OS Select For DRAM > 64MB

Select the operating system that is running with greater than 64MB of RAM on the system. The choice: Non-OS2, OS2.

Report No FDD For Win 95

Whether report no FDD for Win 95 or not.

The choice: Yes, No.

4-3 Advanced Chipset Features

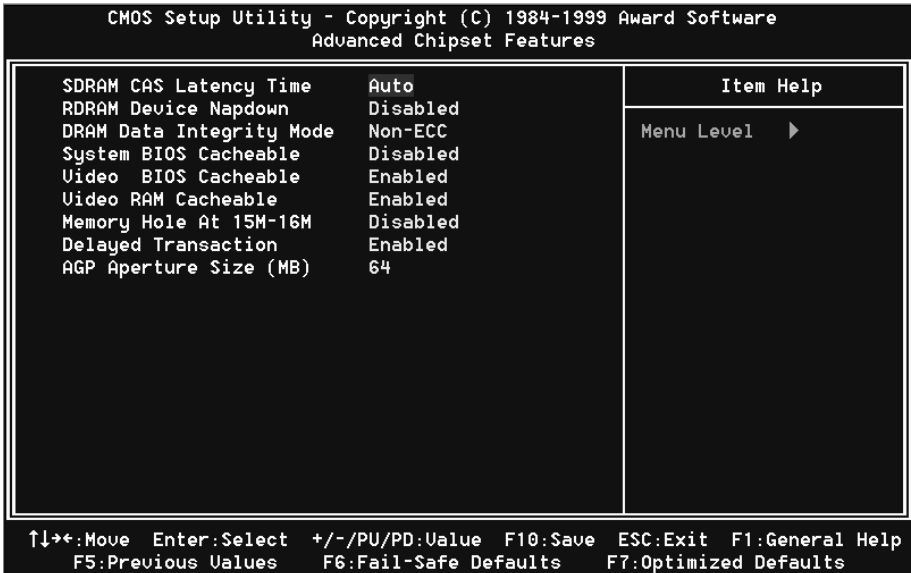

This section allows you to configure the system based on the specific features of the installed chipset. This chipset manages bus speeds and access to system memory resources, such as DRAM and the external cache. It also coordinates communications between the conventional ISA bus and the PCI bus. It must be stated that these items should never need to be altered. The default settings have been chosen because they provide the best operating conditions for your system. The only time you might consider making any changes would be if you discovered that data was being lost while using your system.

DRAM Settings (This field is no function)

The first chipset settings deal with CPU access to dynamic random access memory (DRAM). The default timings have been carefully chosen and should only be altered if data is being lost. Such a scenario might well occur if your system had mixed speed DRAM chips installed so that greater delays may be required to preserve the integrity of the data held in the slower memory chips.

SDRAM CAS Latency Time (This field is no function)

When synchronous DRAM is installed, the number of clock cycles of CAS latency depends on the DRAM timing.

The Choice: 2, 3

RDRAM Device Napdown

Select Enabled the RDRAM channel inactivity counter to start counting the continuous inactivity time.

The Choice: Enabled, Disabled

System BIOS Cacheable

Selecting *Enabled* allows caching of the system BIOS ROM at F0000h-FFFFFh, resulting in better system performance. However, if any program writes to this memory area, a system error may result.

The choice: Enabled, Disabled.

Video BIOS Cacheable

Select Enabled allows caching of the video BIOS , resulting in better system performance. However, if any program writes to this memory area, a system error may result.

The Choice: Enabled, Disabled.

Video RAM Cacheable

This option allows the CPU to cache read/writes of the video RAM. The default is Enabled.

Enabled: This option allows for faster video access.

Disabled: Reduced video performance.

Memory Hole At 15M-16M

You can reserve this area of system memory for ISA adapter ROM. When this area is reserved, it cannot be cached. The user information of peripherals that need to use this area of system memory usually discusses their memory requirements.

The Choice: Enabled, Disabled.

Delay Transaction

The chipset has an embedded 32-bit posted write buffer to support delay transactions cycles. Select *Enabled* to support compliance with PCI specification version 2.1.

The Choice: Enabled, Disabled.

AGP Aperture Size

The amount of system memory that the AGP card is allowed to share. The default is 64.

- 4: 4MB of systems memory accessible by the AGP card.
- 8: 8MB of systems memory accessible by the AGP card.
- 16: 16MB of systems memory accessible by the AGP card.
- 32: 32MB of systems memory accessible by the AGP card.
- 64: 64MB of systems memory accessible by the AGP card.
- 128: 128MB of systems memory accessible by the AGP card.
- 256: 256MB of systems memory accessible by the AGP card.

4-4 Integrated Peripherals



OnChip Primary/Secondary PCI IDE

The integrated peripheral controller contains an IDE interface with support for two IDE channels. Select *Enabled* to activate each channel separately.

The choice: Enabled, Disabled.

IDE Primary/Secondary Master/Slave PIO

The four IDE PIO (Programmed Input/Output) fields let you set a PIO mode (0-4) for each of the four IDE devices that the onboard IDE interface supports. Modes 0 through 4 provide successively increased performance. In Auto mode, the system automatically determines the best mode for each device.

The choice: Auto, Mode 0, Mode 1, Mode 2, Mode 3, Mode 4.

IDE Primary/Secondary Master/Slave UDMA

Ultra DMA/33 implementation is possible only if your IDE hard drive supports it and the operating environment includes a DMA driver (Windows 95 OSR2 or a third-party IDE bus master driver). If your hard drive and your system software both support Ultra DMA/33, select Auto to enable BIOS support.

The Choice: Auto, Disabled.

USB Controller

Select *Enabled* if your system contains a Universal Serial Bus (USB) controller and you have USB peripherals.

The choice: Enabled, Disabled.

USB Keyboard Support

Select *Enabled* if your system contains a Universal Serial Bus (USB) controller and you have a USB keyboard.

The choice: Enabled, Disabled.

Init Display First

This item allows you to decide to active whether PCI Slot or on-chip VGA first

The choice: PCI Slot, Onboard .

AC97 Modem

This item allows you to decide to enable/disable the ICH chipset family to support AC97 Modem.

Select Enable of AC97 Modem item, you must be primary Modem Riser Card (MR) in hardware.

The choice: Enabled, Disabled.

IDE HDD Block Mode

Block mode is also called block transfer, multiple commands, or multiple sector read/write. If your IDE hard drive supports block mode (most new drives do), select Enabled for automatic detection of the optimal number of block read/writes per sector the drive can support.

The choice: Enabled, Disabled

Power On Function

There are “**Button Only**”, “**Hot Key**” and “**Any key**” can be chosen by this field that allows users to select one of these various functions as Power On Method for their requirement. The default value in this selection is “ Hot Key”. (Ctrl-F1)

Hot Key: User can press “Control Key” (Ctrl) and “Function Key” (from F1 to F12) individually to power on the system. The interval between “Ctrl” key and function Key (F1-F12) must be short.

Anykey: Press anykey to power on the system.

Button Only: This power on function controlled by J3 (pw-on.) Use Power On Button to power on the system.

Password: User can Power On the System by password, the password can be entered from 1 to 5 characters. The maximum of password is 5 characters. If user forget / lost the password, please turn off the system and open case to clear CMOS by JP1 to re-setting the power on function. When set the password to turn on the system, than can't power on by J3(PW-ON).

KB Power On Password

When the option of "Power On Function" is password selected, user uses the item to key in password.

Hot Key Power On

Use this option with the above "Power On Function" to set a combination of keys that can be used to power the system on. The default is Ctrl-F1.

Options: Ctrl-F1, Ctrl-F2, Ctrl-F3, Ctrl-F4, Ctrl-F5, Ctrl-F6, Ctrl-F7, Ctrl-F8, Ctrl-F9, Ctrl-F10, Ctrl-F11, and Ctrl-F12.

Onboard FDC Controller

Select Enabled if your system has a floppy disk controller (FDC) installed on the system board and you wish to use it. If you install and-in FDC or the system has no floppy drive, select Disabled in this field.

The choice: Enabled, Disabled.

Onboard Serial Port 1/Port 2

Select an address and corresponding interrupt for the first and second serial ports.

The choice: 3F8/IRQ4, 2E8/IRQ3, 3E8/IRQ4, 2F8/IRQ3, Disabled, Auto.

UART Mode Select

This field allows the users to configure what IR mode the 2nd serial port should use. The default is Normal.

Optional: Normal, IrDA and ASKIR.

RxD, RxD Active

This field configures the receive and transmit signals generated from the IR port. The default is Hi Lo (when UART Mode Select is not set to Normal).

Options: Hi Hi, Hi Lo, Lo Hi, and Lo Lo.

IR Transmission delay

The default is Enabled (when UART Mode Select is not set to Normal).

Options: Enabled and Disabled.

Onboard Parallel port

This field allows the user to configure the LPT port.

The default is 378H / IRQ7.

378H: Enable Onboard LPT port and address is 378H and IRQ7.

278H: Enable Onboard LPT port and address is 278H and IRQ5.

3BCH: Enable Onboard LPT port and address is 3BCH and IRQ7.

Disabled: Disable Onboard LPT port.

Parallel Port Mode

This field allows the user to select the parallel port mode.

The default is ECP+EPP.

Normal: Standard mode. IBM PC/AT Compatible bidirectional parallel port.

EPP: Enhanced Parallel Port mode.

ECP: Extended Capabilities Port mode.

EPP+ECP: ECP Mode & EPP Mode.

ECP Mode Select

This item allows you to determine the IR transfer mode of onboard I/O chip.
options: EPP1.9, EPP1.7.

ECP Mode USE DMA

This field allows the user to select DMA1 or DMA3 for the ECP mode.

The default is DMA3.

DMA1: This field selects the routing of DMA1 for the ECP mode.

DMA3: This field selects the routing of DMA3 for the ECP mode.

PWRON After PW-Fail

The system will stay off or power on after a power interrupte.

The default is Fomer-Status.

Fomer-Status: Stay off or power on depend on system safe shut-down or power fail.

ON: System always power on after a power interrupte.

OFF: System always stay off after a power interrupte.

4-5 Power Management Setup

The Power Management Setup allows you to configure you system to most effectively save energy while operating in a manner consistent with your own style of computer use.

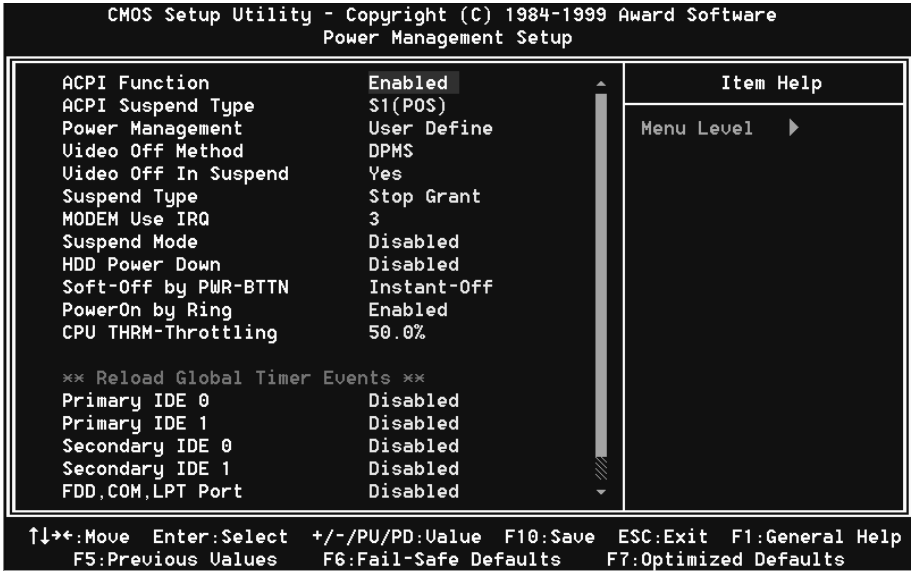

ACPI Function

This item allows you to enable/disable the Advanced Configuration and Power Management (ACPI).

The choice: Enabled, Disabled.

ACPI Suspend Type

This item allows you to select S1(POS) or S3(STR) function.

The choice: S1(POS), S3(STR).

Power Management

This category allows you to select the type (or degree) of power saving and is directly related to the following modes:

1. HDD Power Down
2. Doze Mode
3. Suspend Mode

There are four selections for Power Management, three of which have fixed mode settings.

Disable (default)	No power management. Disables all four modes
Min. Power Saving	Minimum power management. Doze Mode = 1 hr. Standby Mode = 1 hr., Suspend Mode = 1 hr., and HDD Power Down = 15 min.
Max. Power Saving	Maximum power management -- ONLY AVAILABLE FOR SL CPU's. Doze Mode = 1 min., Standby Mode = 1 min., Suspend Mode = 1 min., and HDD Power Down = 1 min.
User Defined	Allows you to set each mode individually. When not disabled, each of the ranges are from 1 min. to 1 hr. except for HDD Power Down which ranges from 1 min. to 15 min. and disable.

Video Off Method

This determines the manner in which the monitor is blanked.

V/H SYNC+Blank	This selection will cause the system to turn off the vertical and horizontal synchronization ports and write blanks to the video buffer.
Blank Screen	This option only writes blanks to the video buffer.
DPMS	Initial display power management signaling.

Video Off In Suspend

This determines the manner in which the monitor is blanked.

The choice: Yes, No.

Suspend Type

Select the Suspend Type.

The choice: PWRON Suspend, Stop Grant.

MODEM Use IRQ

This determines the IRQ in which the MODEM can use.

The choice: 3, 4, 5, 7, 9, 10, 11, NA.

Suspend Mode

When enabled and after the set time of system inactivity, all devices except the CPU will be shut off.

The choice: Enabled, Disabled.

HDD Power Down

When enabled and after the set time of system inactivity, the hard disk drive will be powered down while all other devices remain active.

The choice: Enabled, Disabled.

Soft-Off by PWRBTN

Pressing the power button for more than 4 seconds forces the system to enter the Soft-Off state when the system has “hung.” The default is Instant-off.

The choice: Delay 4 Sec, Instant-Off.

PowerOn By Ring

This option is used to set the remote ring in and Wake on LAN (WOL) features.

The choice: Enabled, Disabled.

CPU THRM-Throttling

Select the CPU THRM-Throttling rate.

The choice: 25.0%, 37.5%, 50.0%, 62.5%, 75.0%, 87.5%.

**** PM Events ****

PM events are I/O events whose occurrence can prevent the system from entering a power saving mode or can awaken the system from such a mode. In effect, the system remains alert for anything which occurs to a device which is configured as *Enabled*, even when the system is in a power down mode.

Primary IDE 0

Primary IDE 1

Secondary IDE 0

Secondary IDE 1

FDD, COM, LPT Port

PCI PIRQ[A-D] #

4-6 PnP/PCI Configuration Setup

This section describes configuring the PCI bus system. PCI, or **P**ersonal **C**omputer **I**nterconnect, is a system which allows I/O devices to operate at speeds nearing the speed the CPU itself uses when communicating with its own special components. This section covers some very technical items and it is strongly recommended that only experienced users should make any changes to the default settings.



Reset Configuration Data

Normally, you leave this field Disabled. Select Enabled to reset Extended System Configuration Data (ESCD) when you exit Setup if you have installed a new add-on and the system reconfiguration has caused such a serious conflict that the operating system can not boot.

The choice: Enabled, Disabled .

Resource controlled by

The Award Plug and Play BIOS has the capacity to automatically configure all of the boot and Plug and Play compatible devices. However, this capability means absolutely nothing unless you are using a Plug and Play operating system such as

Windows95. If you set this field to “manual” choose specific resources by going into each of the sub menu that follows this field (a sub menu is preceded by a “Ø”). The choice: Auto(ESCD), Manual.

PCI/VGA Palette Snoop

Leave this field at *Disabled*.

Choices are Enabled, Disabled.

4-7 PC Health Status

CMOS Setup Utility - Copyright (C) 1984-1999 Award Software
PC Health Status

CPU Warning Temperature	95°C/205°F	Item Help
Current System Temp.	33°C/91°F	
Current CPU Temperature	59°C/138°F	Menu Level ▶
Current CPU Fan Speed	0 RPM	
Current Power Fan Speed	0 RPM	
Current Chassis Fan Speed	0 RPM	
Utt (U)	1.53V	
Ucore(U)	2.09V	
Ucc (U)	3.42V	
+ 5U (U)	4.97V	
+12U (U)	12.16V	
-12U (U)	-12.28V	
- 5U (U)	-5.09V	
UBAT (U)	3.48V	
5USB (U)	4.89V	
Shutdown Temperature	100°C/212°F	
Warning Beep	Enabled	

↑↓←→:Move Enter:Select +/-/PU/PD:Value F10:Save ESC:Exit F1:General Help
F5:Previous Values F6:Fail-Safe Defaults F7:Optimized Defaults

CPU Warning Temperature

This is the temperature that the computer will respond to an overheating CPU. The default is Disabled.

Enabled: Temperature is monitored on the CPU, default is 95°C/205°F.

Disabled: This feature is turned off.

Current System Temp

This is the Current temperature of the system.

Current CPU Temperature

This is the current temperature of the CPU.

Current CPU Fan/ Power Fan/ Chassis Fan Speed

The current CPU fan speed in RPMs.

CPU(V)

The voltage level of the Vtt, Vcore, Vcc.

+5V, +12V, -12V, -5V, VBAT, 5VSB: The voltage level of the switch power supply.

Shutdown Temperature

This is the temperature that the computer will turn off the power to combat the effects of an overheating system. (requires ACPI to be enabled in Power Management BIOS and ACPI compliant operating system.) The default is 100°C/212°F.

Options available are 60°C/140°F to 100°C/212°F in increments of 5°C.

4-8 Frequency/Voltage Control

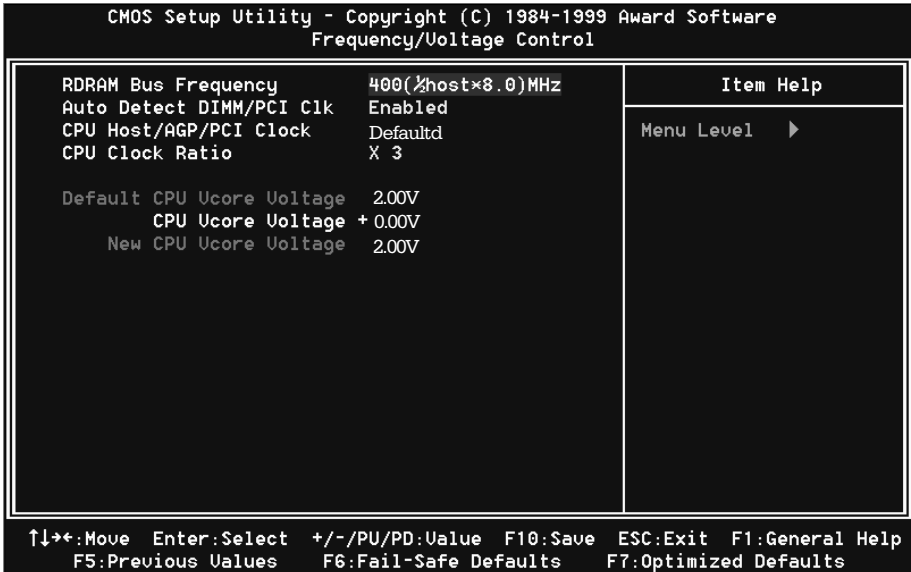

RDRAM Bus Frequency

This item allows you to select the RDRAM’s running frequency. The RDRAM timing are very tight. Make sure the correct RDRAM speed and choice the right item for more stable in the system.

The choice: This item according the difference of CPU’s FSB that is 100MHz or 133MHz.

Note: The RDRAM Bus memory time is difference with SDRAM. If you set the RDRAM Bus Frequency to be too high, then the system will not turn on again (no display). You can clear CMOS by shorting JP1’s 2-3 pin (momentarily), while the system is off. The system should be turn on by the default value.

Auto Detect DIMM/PCI Clk

This item allows you to enable/disable auto detect DIMM/PCI Clock.
The choice: Enabled, Disabled.

CPU Host/AGP/PCI Clock

The mainboard is designed to set the CPU Host/AGP/PCI clock at jumperfree. This item allows you to select the CPU Host speed and PCI clock speed by “Enter” key. If “default” is means the CPU Host speed that depend on the CPU is 100MHz or 133MHz.

CPU Clock Ratio

This item allows you to select the CPU ratio. If the CPU ratio is fixed. This item was no function. Configuration options: [3.x]...[7x], [7.5x], [8.x].

CPU Vcore Voltage

This item allows you to increase the CPU Vcore Voltage.

4-9 Defaults Menu

Selecting “Defaults” from the main menu shows you two options which are described below

Load Fail-Safe Defaults

When you press <Enter> on this item you get a confirmation dialog box with a message similar to:

Load Fail-Safe Defaults (Y/N) ? N

Pressing ‘Y’ loads the BIOS default values for the most stable, minimal-performance system operations.

Load Optimized Defaults

When you press <Enter> on this item you get a confirmation dialog box with a message similar to:

Load Optimized Defaults (Y/N) ? N

Pressing ‘Y’ loads the default values that are factory settings for optimal performance system operations.

4-10 Supervisor/User Password Setting

You can set either supervisor or user password, or both of them. The differences between are:

supervisor password : can enter and change the options of the setup menus.

user password : just can only enter but do not have the right to change the options of the setup menus. When you select this function, the following message will appear at the center of the screen to assist you in creating a password.

ENTER PASSWORD:

Type the password, up to eight characters in length, and press <Enter>. The password typed now will clear any previously entered password from CMOS memory. You will be asked to confirm the password. Type the password again and press <Enter>. You may also press <Esc> to abort the selection and not enter a password. To disable a password, just press <Enter> when you are prompted to enter the password. A message will confirm the password will be disabled. Once the password is disabled, the system will boot and you can enter Setup freely.

PASSWORD DISABLED.

When a password has been enabled, you will be prompted to enter it every time you try to enter Setup. This prevents an unauthorized person from changing any part of your system configuration.

Additionally, when a password is enabled, you can also require the BIOS to request a password every time your system is rebooted. This would prevent unauthorized use of your computer.

You determine when the password is required within the BIOS Features Setup Menu and its Security option (see Section 3). If the Security option is set to "System", the password will be required both at boot and at entry to Setup. If set to "Setup", prompting only occurs when trying to enter Setup.

4-11 Exit Selecting

Save & Exit Setup

Pressing <Enter> on this item asks for confirmation:

Save to CMOS and EXIT (Y/N)? Y

Pressing “Y” stores the selections made in the menus in CMOS – a special section of memory that stays on after you turn your system off. The next time you boot your computer, the BIOS configures your system according to the Setup selections stored in CMOS. After saving the values the system is restarted again.

Exit Without Saving

Pressing <Enter> on this item asks for confirmation:

Quit without saving (Y/N)? Y

This allows you to exit Setup without storing in CMOS any change. The previous selections remain in effect. This exits the Setup utility and restarts your computer.

Section 5

820 and Sound Driver Installation

Easy Driver Installation



- Step 1 :** To Click the Intel 810 and 820 Chipset INF Files that enable the Intel(R) 810 Chipsets to be recognized by listed operating systems. This installer will unpack updated .INF files into a specified folder. Supported operating systems: Microsoft Windows* 95 OSR 2.1+ and Windows* 98 operating systems.
- Step 2 :** To Click the Intel 810 and 820 INF Installation Utility. This installer will install updated .INF files onto the target machine. Supported operating systems: Microsoft Windows* 95 OSR 2.1+ and Windows* 98 operating systems. This procedure will Re-start the system.
- Step 3 :** To Click the Audio Driver/Utilities to installation the Audio Sound Driver in operating system.

Page Left Blank

Section 6

PCI Audio Sound

CMI8738 Features:

- **Special Features**

PCI Plug and Play (PnP) bus interface, 32 bit PCI bus master.

Full duplex playback and recording, built-in 16 bits CODEC.

HRTF 3D positional audio, supports both Direct Sound 3D® & A3D® interfaces, supports earphones, two and four channel speakers mode.

Support Windows 3.1 / 95 / 98 and Windows NT 4.0.

Built-in 32 OHM Earphone buffer and 3D surround.

MPU-401 Game/Midi port and legacy audio SB16 support.

Downloadable Wave Table Synthesizer, supports Direct Music®.

- **Digital Audio (SPDIF IN/OUT)-(Optional)**

Up to 24 bit stereo 44KHz sampling rate voice playback/recording.

Full duplex playback and recording, 120dB audio quality measured.

Auto detectable SPDIF/IN signal level from 0.5V to 5V.

- **Stereo Mixer and FM Music Synthesizer**

Stereo analog mixing from CD-Audio, Line-in

Stereo digital mixing from Voice, FM/Wave-table, Digital CD-Audio

Mono mixing from MIC and software adjustable volume

OPL3 FM synthesizer (4 operators)

Up to 15 melody sounds and 5 rhythm sounds (20 voices)

- **Game and Midi Interface**

Fully compatible with MPU-401 Midi UART and Sound Blaster Midi mode/ Standard IBM PC joystick/game port (dual channels)

Connectors and Jumper setting informations

Connector	Function
AUX-IN	AUX_IN Port (Signals: L – G – G – R)
CD-IN	Analog CD/IN Port (Signals: L-G-G-R)
MODEM-IN	Telephony Connector (Signals Audio-In-G-G-Mic-out to Modem)
JX2	OPTICAL SPDIF- I/O
LINE_IN	Connect with the audio output port of stereo or normal line in. Turn on or turn off by 4SPK in the Audio Rack Appc.
MIC	Connect with the Microphone (Mono)
LINE_OUT	Output to speakers with the amplifier or earphones or Audio_IN of home stereo
SPDIF_OUT	Connect with Mini Disk, LD Player or AC3 Amplifier
GAME/MIDI	Connect with Joystick or devices that use MIDI interface

Dos Installation

Before beginning the installation, please make sure that your hard disk has sufficient space(min. 4MB). Insert the Driver CD into the CD-ROM Drive.

1. Change directory to PCI audio DOS drivers folder (ex. D:\DOSDRV) at DOS prompt, and type:

INSTALL [Enter]

2. Type DOS utilities path which you want to install.
3. Program will expand the file to the path which you've specified.
4. Install program will add initial drivers into AUTOEXEC.BAT file.

Win95/98 Installation

We recommend that you install Microsoft Windows before you install this PCI sound card, and you not install any other sound card device drivers in your current system.

1. Power off your system, install the PCI sound card, audio cable, speaker, microphone, and insert driver CD into the CD-ROM drive.
2. Turn on the computer, and enter the Microsoft Windows 95 / 98.
3. You will see a windows prompt like this:
"New Hardware Found
PCI Multimedia Audio Device
Windows has found new hardware and is installing the software for it", then the dialog box shown. Click "Next" button to go on.
4. Click on "Other Locations..." button to specify drivers path.
5. When CMI8738/C3DX PCI Audio Device found, click "Finish".
6. Now, system is installing device drivers automatically. After a while, the system will finish the installation includes the following device drivers.
CMI8738/C3DX PCI Audio Device
CMI8738/C3DX PCI Audio Joystick Device
CMI8738/C3DX PCI Audio Legacy Device
DOS mode MPU-401 Emulator

8. Click “start” key
9. Select “Run”
10. Key in the drive and path for Windows application installation program, for example, “D:\W95-98\APP\SETUP.EXE”
11. Click “OK” to start the installation procedure, and follow the on-screen instructions to finish the installation. When all the application softwares have been installed, please shut down Windows 95/98 system, and reboot your system.

Win95/98 Un-Installation

If you install Win95/98 and a sound card at the same time, you might experience some technical difficulties(the device might not function properly). It is suggested that you proceed with the un-install procedure:

1. Click “start” button.
2. Select “run” item.
3. Find UINSTDRV.EXE in driver disk under Win95/98 drivers folder.
4. Run it.
5. Follow the on-screen instructions to re-install the hardware.

If you want to completely remove the drivers, you can also run the un-install procedure as described previously. Remove the sound card from the slot, and then reboot the system.

Windows NT 4.0 Installation

We recommend that you install Windows NT 4.0 before you install this onboard's PCI audio , and you not install any other sound card device drivers in your current system.

1. Click "Start" button, move the highlight bar to "Setting" item, and select the "Control Panel".
2. Double-click "Multimedia" icon.
3. Select "Devices" page, and press "Add" button.
4. Select "Unlisted or Updated Driver" item in "List of Drivers".
5. Specify the drive and the path where NT drivers are in (such as D:\NT40\DRV).
6. Select "C-Media CM8738" item and press "OK" button.
7. Select proper I/O value.
8. Press "OK" button.
9. Restart the system when being asked.
10. Now, you have already installed the PCI Audio Adapter under Microsoft Windows NT 4.0 successfully. if you want to install the Windows applications, continue the following steps:
11. Click "start" key.
12. Select "Run" item.
13. Key in drive and path for Windows NT application installation program, for example, "D:\NT40\APP\SETUP.EXE"
14. Click "OK" to start the installation procedure, and follow the on-screen instructions to finish the installation. When all of application softwares have been installed, shut down the Windows NT system, and then reboot your system.

Windows Appc. (The Audio Rack)

Introduction

By means of a user-friendly interface(as easy as operating your home stereo system), this PCI audio rack provides you with the control over your PC’s audio functions, including the advantage of four speakers mode enable/ disable.



This Audio Rack consists of several major components:

Control Center: Controls the display of the PCI Audio Rack's components.



MIDI Player: Plays MIDI music files, and allows you to create your personal song playlists, and play the song files.

MP3/Wave Player: Records and plays digital audio (mp3/wave) files. Allows you to create wave file playlists, and playback the wave files.

CD Player: Plays standard audio CDs. Allows you to create your favorite song playlists.

System Mixer: Controls the volume level of your audio inputs and outputs.

Showing or Hiding Audio Rack Components

To remove or add a component from the display, click on the component's button on the Control Center's Button Bar or toggle it off.

MIDI Player, Wave Player, and CD Player



CD Player (above, similar to Wave Player and MIDI Player)

Sel (or Trk) field: If you have multiple selections in your playlist, this shows the number of the current selection or CD track.

Current File or Track: The name of the current MIDI file, wave audio file, or CD track.

Total Length field: displays the total length of files or tracks in minutes and seconds.

Current Time field: displays the current time of files or tracks in minutes and seconds when playback or recording.

Please refer to the help screen for more detail button function descriptions.
(click on help “  ” button on the player)

System Mixer

System Mixer allows you to control all the audio output and input levels. System Mixer displays the volume controls which your audio drivers make available. *The names for these controls may vary.*

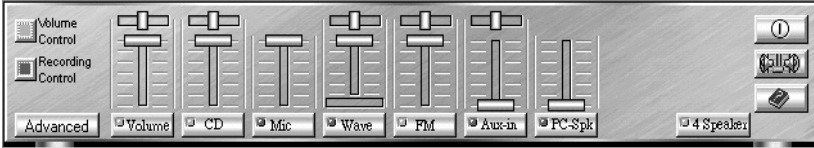

Mixer panel while the four speakers mode is enabled.

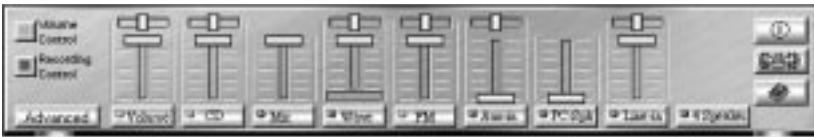

Mixer panel while the four speakers mode is disabled.

Volume Control: Clicking on this button shows and allows you to use the output level controls.

Recording Control: Clicking on this button shows and allows you use the input level controls.

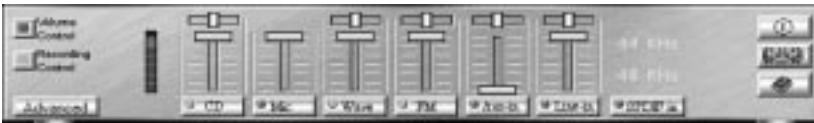

Input and Output Level Sliders and Buttons: For each input or output signal type, the control slider controls the loudness whereas the horizontal slider controls the balance between the two speakers. The mute button temporarily stops input or output without changing slider positions.

Control types and names might vary. The common types are listed below:

- **Vol:** The master control for all outputs. The strength of an output signal is determined by both the Vol slider and the slider for the individual output. To affect *all* outputs, move the Vol slider. To change the output of an *individual* output type, move *its* slider.
- **Line-in/Rear:** Controls the audio hardware's Line In or Line Out levels. Line levels might be for an externally attached cassette player, for instance, while the four speakers mode is enabled, this control becomes the Rear speaker volume control.

- **Mic:** Controls the microphone input level.
- **Wave:** Controls wave (voice) playback or the recording levels.
- **FM:** Controls the FM music playback or the recording level.
- **Aux-in:** Controls the Aux-in music play or the recording level.
- **CD:** Controls the CD drive output level, for CD drives configured to play their audio output through the PC's audio hardware.
- **4SPK:** Turn on or turn off the Rear speakers effect.
- **Surround:** Turn on or turn off the 3D surround sound effect.
- **SPDIF-in:** Turn on or turn off the SPDIF digital signal input.
- **Advanced:** Check the SPDIF status, HRTF 3D sound CPU Utilization, turn on the Microphone Booster.

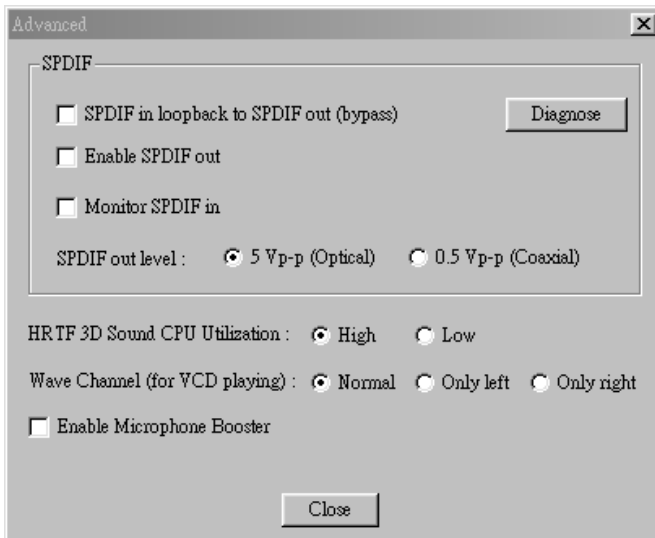

Mute Buttons: Toggle between muting and enabling the signal. A button with a lit LED is enabled, and when it is not lit, it means it is mute. Several *output* signals can usually be enabled at once.

MP3 Player

MP3 player can play both wave files and MP3 files.

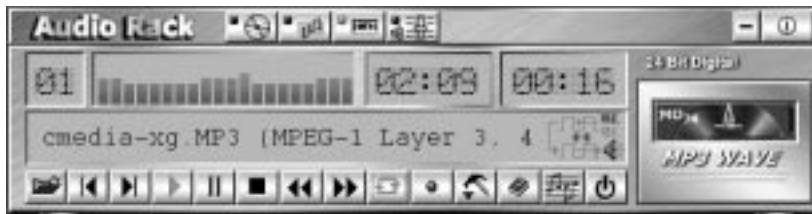

MP3 player while the loop function enables.

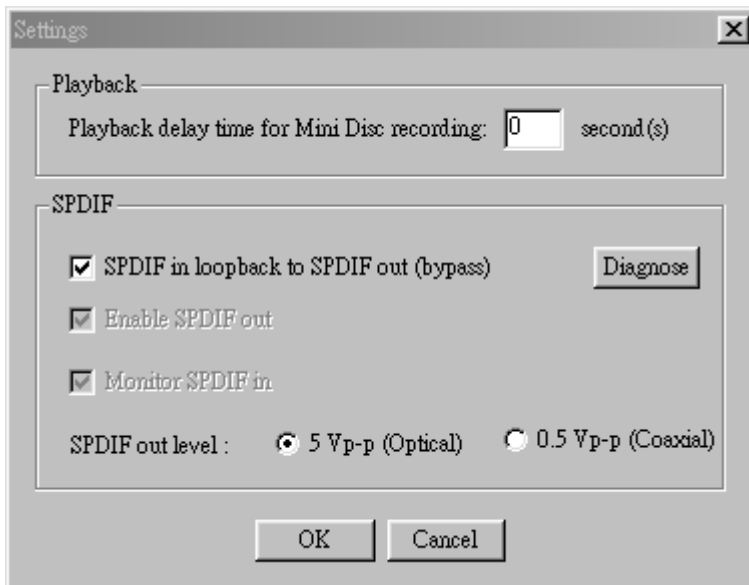

The settings' window while one of the SPDIF functions is enable.

The 4 Speakers System

This Audio Adapter provides 2 wave channels(front/rear), known as the 4 speakers system. When games or application programs via DirectSound® 3D or A3D® interface locate the sound sources to the listener's back, the two rear speakers will work to enhance the rear audio positional effect, so as to complement the insufficiency of using only two front speakers to emulate the audio effect. The following is the hardware installation and the software setups:

1. The speaker installation.

Connect the front pair speakers to the Line-out jack of the audio adapter, and then connect rear pair speakers to Line-in/Rear jack of the audio adapter. The original Line-in can be moved to Aux-in.

2. The positions of the speakers

Put your speakers the way the following picture suggests, so as to avail yourself to the best audio result.

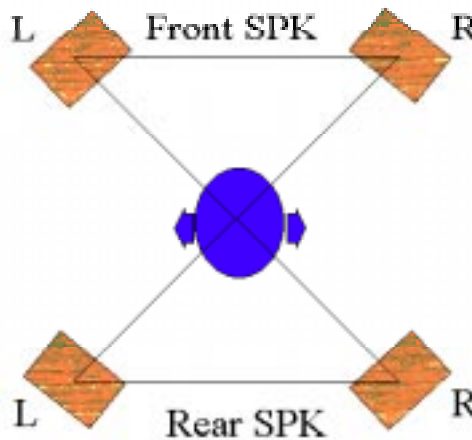

3. The mixer setup

There is a 4 speakers option in the volume control of the mixer, and when you enable this option, it means the rear speakers are connected to Line-in/Rear jack. When Line-in/Rear jack is connected to other external Line-in sources, please DO NOT enable this option in order to avoid hardware conflicts. Regarding rear speaker option, you can turn on or turn off the output of the back speakers, and adjust the volume, to have the rear/front speakers have the same volume.

4. The demo

Execute the “Helicopter” demo within the C3D HRTF Positional Audio Demos of this audio adapter. When the helicopter flies behind you, the rear speakers will work.

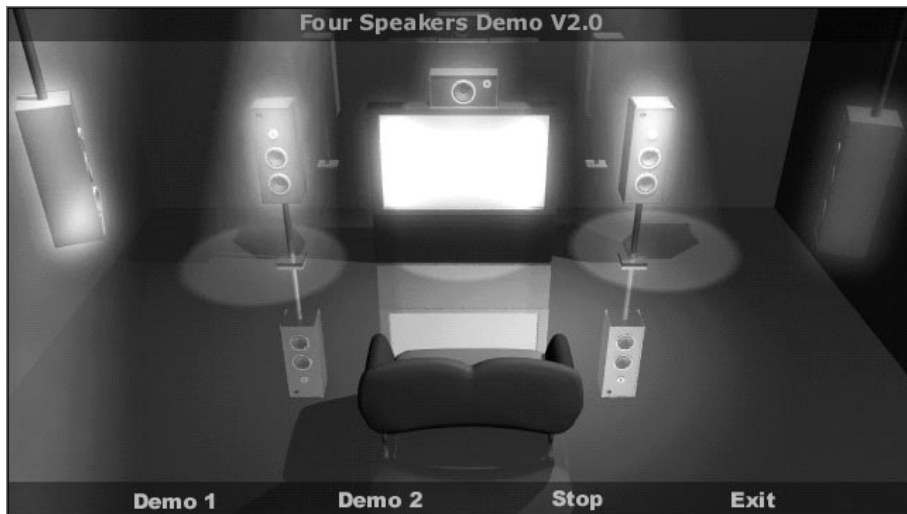

DEMO1: Present to you the complete 4-speaker surround sound effect.

DEMO2: Present to you the sound effects of each speaker.

You may also use the mouse to select any speaker and click it to make it work.

**Optical Fiber Application in CMI8738 SPDIF/OUT
(MD/Onboard's Sound/MP3 Player Setup)**

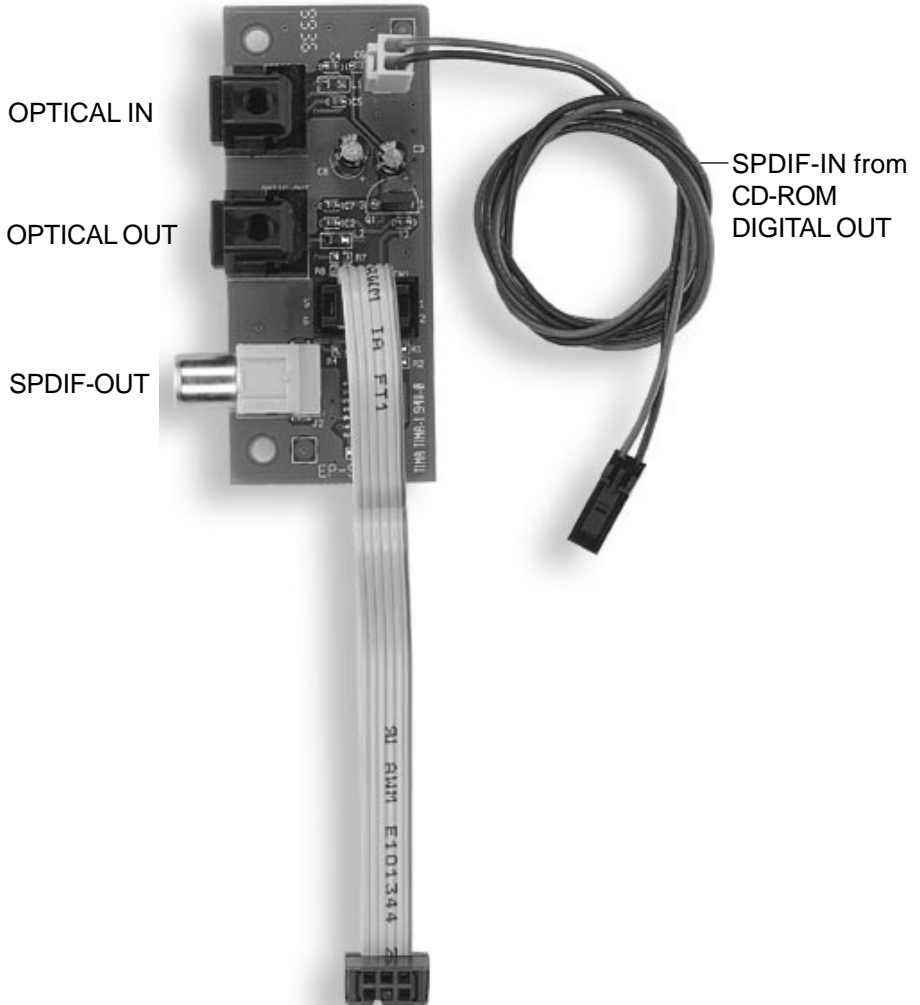

OPTICAL SPDIF-I/O from M.B's JX2

Optical SW Setting



EP-SPDIF0

An optical fiber is used to connect the onboard's sound and the MD.

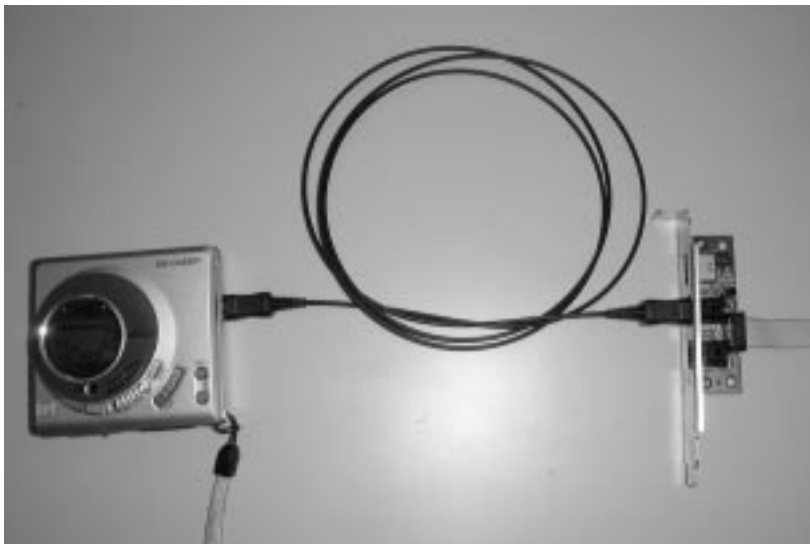

The application program setup (please install CMI8738 application program first)

When the connection is done, please go to the Start menu and select PCI Audio Applications\Audio Environment Setting.

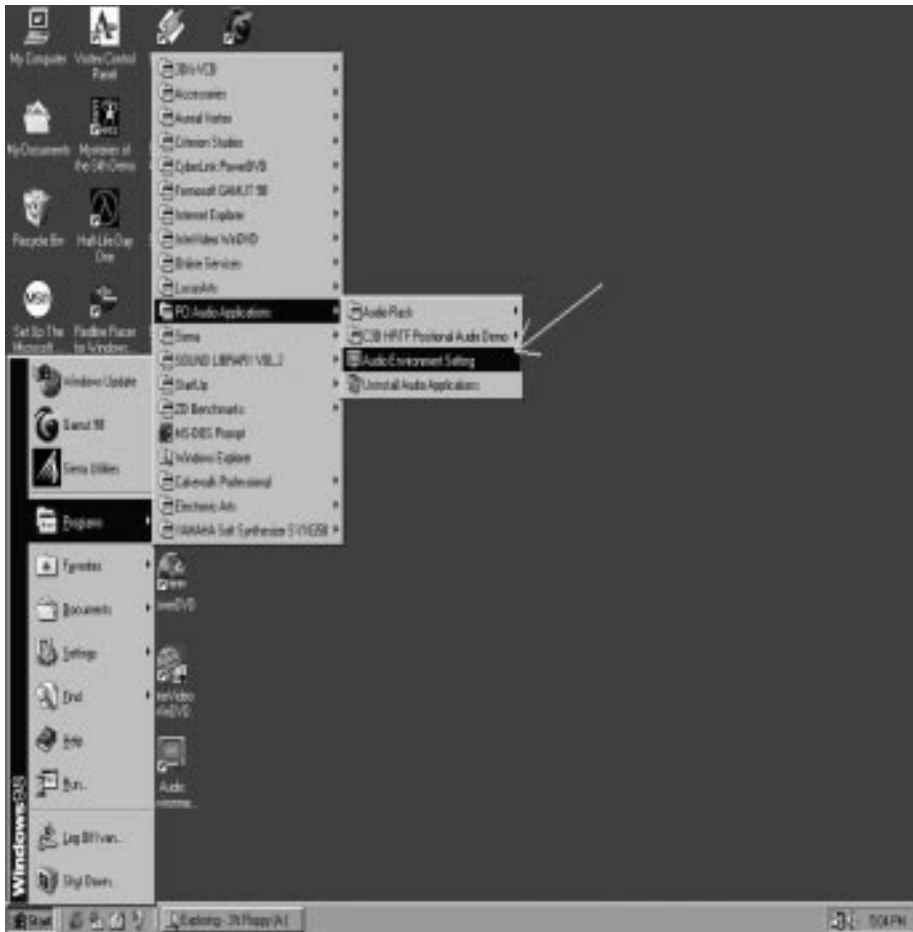

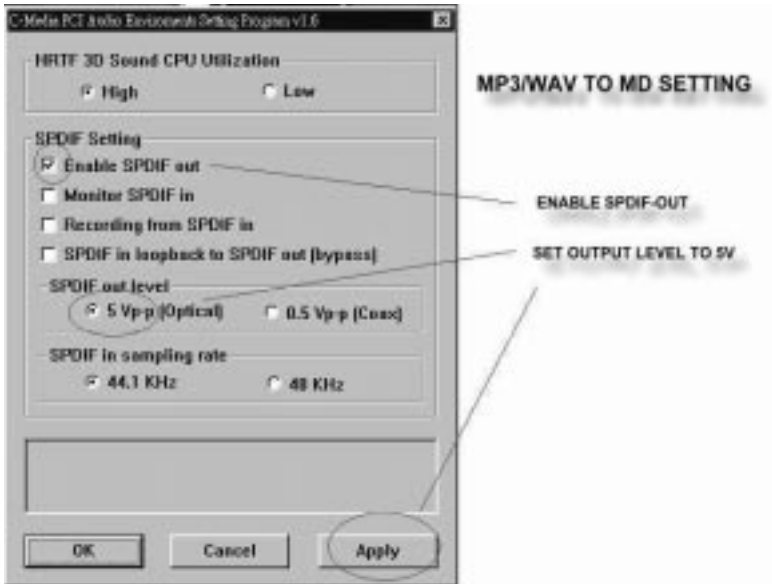

When all the procedures have been completed, there will be an infrared signal coming from the SPDIF/OUT of the optical fiber of the sound card.



Please note that signal beam may cause severe damage to the eyes. For your safety, please point the output end to a piece of white paper to check if the beam is in function.

Please connect the output signal to the MD input, then play the music via the MP3 player:



Please note that in playback, if there is no gap longer than three seconds between each track, the MD can not recognize the tracks and will record all of them into one. It is recommended that you set the gap time to 3~5 seconds to meet all type of MD requirements.

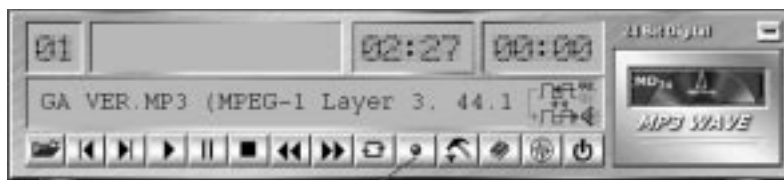

RECORDING FORMAT AND RECORDING CHANNEL SETTING

About Recording 24bit Audio Setting

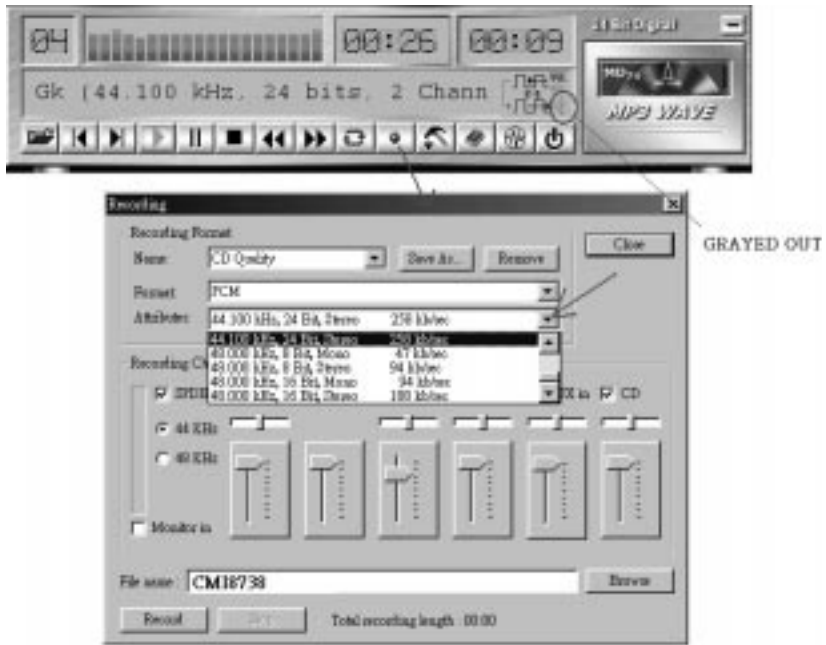

24-bit audio can only be applied to SPDIF IN/OUT mode; it does not apply to other modes such as the four channels or the analog. No sound will be heard while in playback, yet it can be recorded.



The un-selected area will be grayed out.



The un-selected area will be grayed out.



The un-selected area will be grayed out.

You can double-click this circuit icon to have the following setting box. By means of this setting box, you can also complete the above-mentioned setting procedures.



DOUBLE CLICK IT

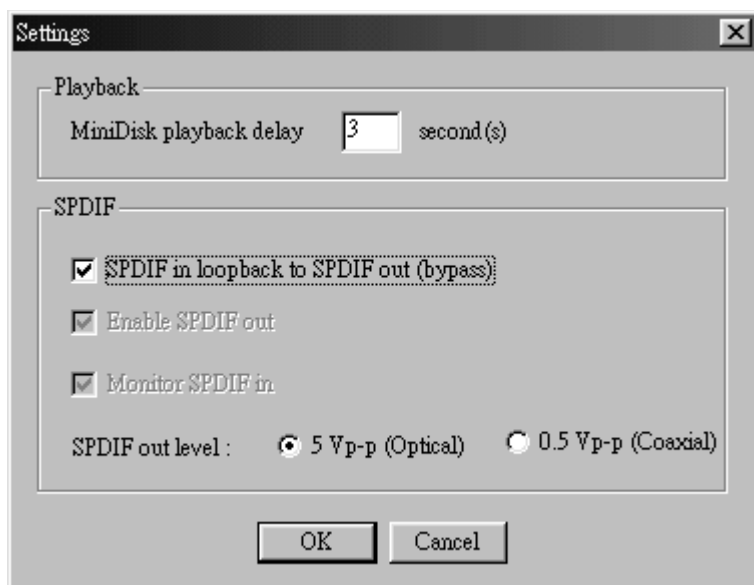

CMI8738 SPDIF/IN

Portable CD Player(Output) to CMI8738(Optical Input)Setup

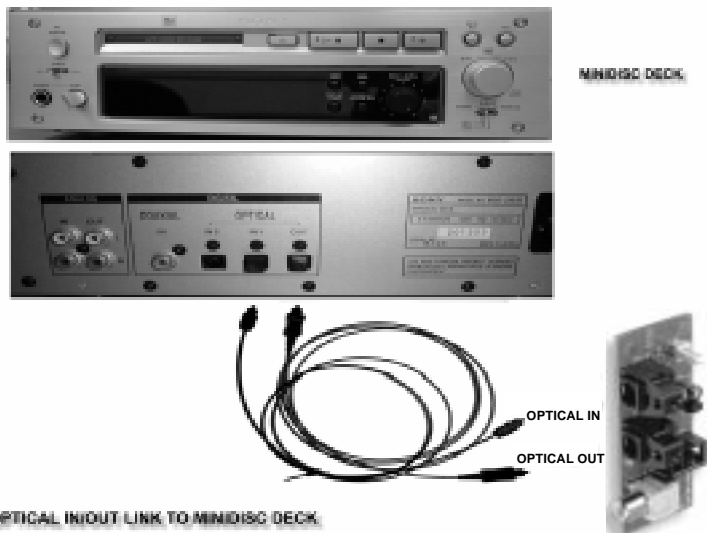

When the connection is done, please go to the Start menu and select PCI Audio Applications\Audio Environment Setting

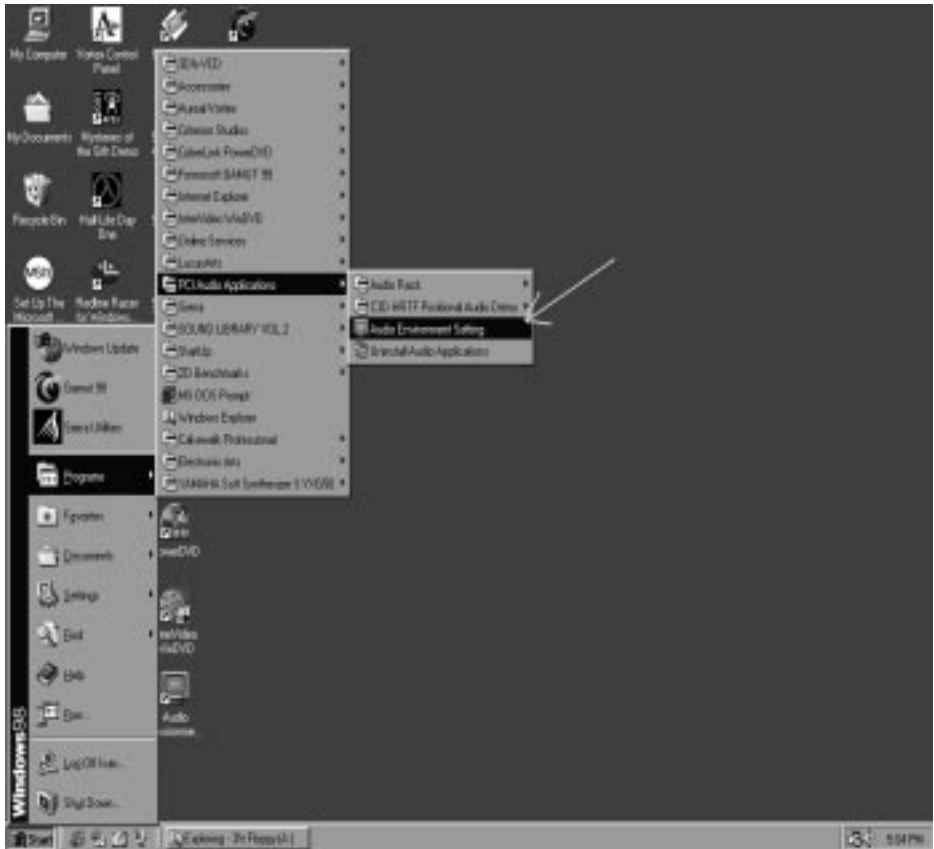

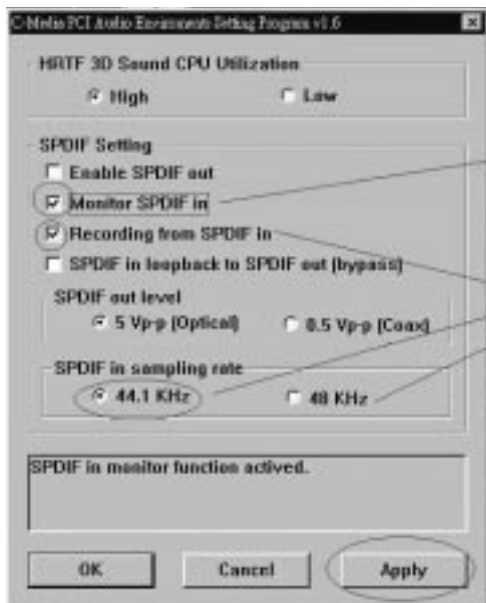

SPDIF-IN SETTING

SPDIF IN TO AUDIO CHIP DAC OUT

WAV RECORDING FROM SPDIF-IN

SPDIF-IN SAMPLING RATE SETUP

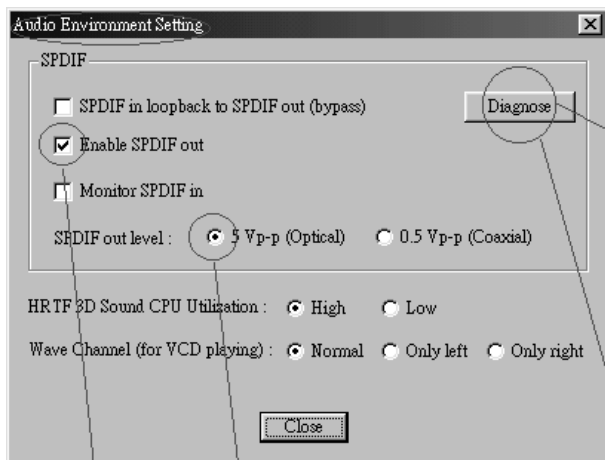

If you got the noise signal from CD digital output. Please press [Diagnose] button. It will detect the signal of your SPDIF and change it to be the correct format.

ENABLE SPDIF OUT

SET OUTPUT LEVEL TO 5V

MP3/WAV TO MD SETTING

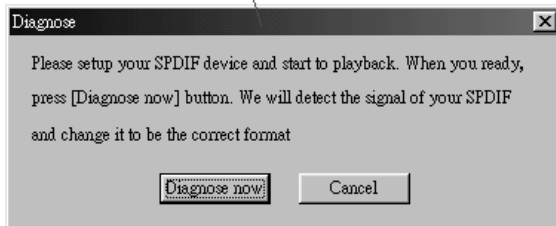

Loopback(bypass)mode setup

CD ROM(Digital Output) to CMI8738(SPDIF/IN)Setup



CD-ROM DIGITAL OUT

J1:SPDIF-IN

CD-ROM DIGITAL OUT TO SPDIF-IN



When the connection is done, please go to the Start menu and select PCI Audio Applications\Audio Environment Setting

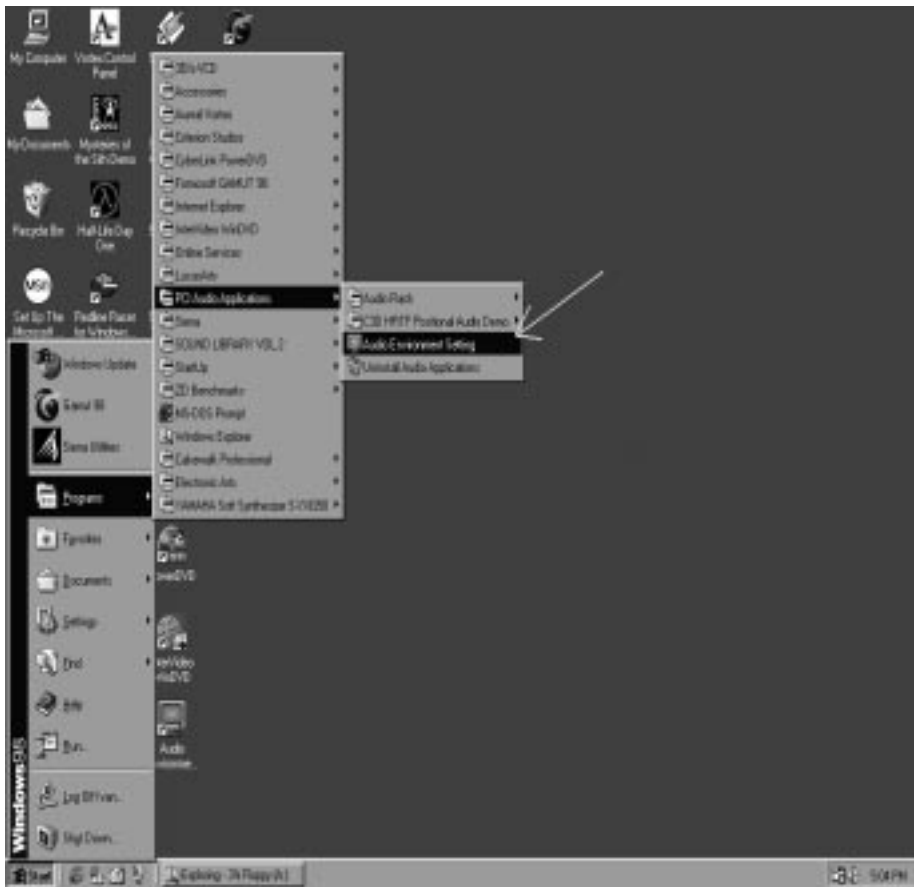

Please follow these setting procedures.

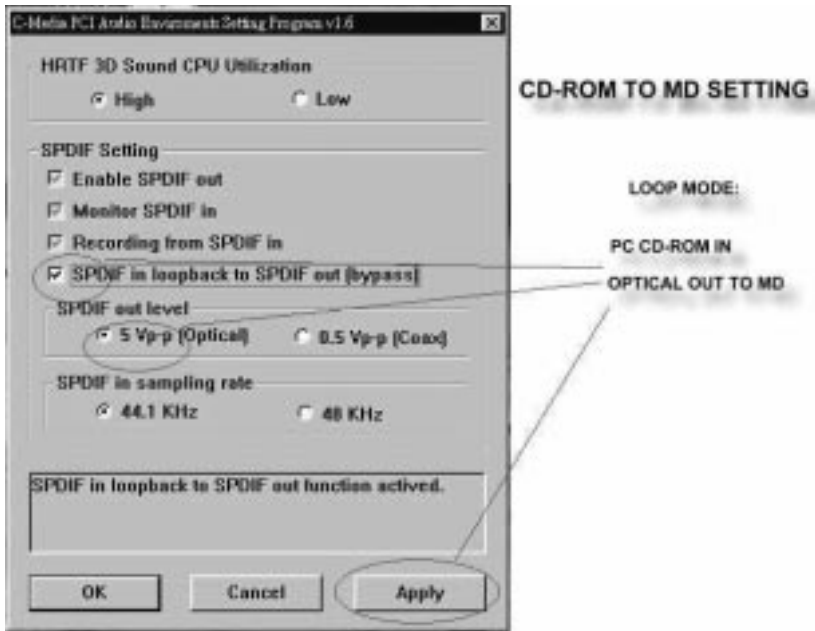

Now you can insert the CD into the CD ROM drive,then activate C-MEDIA CD player and push the "play" button to do the recording job.



Please note that you have to set the MD in the simultaneous-recording mode.

Page Left Blank

Appendix A

A-1 MEMORY MAP

Address Range	Size	Description
[00000-7FFFF]	512K	Conventional memory
[80000-9FBFF]	127K	Extended Conventional memory
[9FC00-9FFFF]	1K	Extended BIOS data area if PS/2 mouse is installed
[A0000-C7FFF]	160K	Available for Hi DOS memory
[C8000-DFFFF]	96K	Available for Hi DOS memory and adapter ROMs
[E0000-EEFFF]	60K	Available for UMB
[EF000-EFFFF]	4K	Video service routine for Monochrome & CGA adaptor
[F0000-F7FFF]	32K	BIOS CMOS setup utility
[F8000-FCFFF]	20K	BIOS runtime service routine (2)
[FD000-FDFFF]	4K	Plug and Play ESCD data area
[FE000-FFFFF]	8K	BIOS runtime service routine (1)

A-2 I/O MAP

[000-01F]	DMA controller.(Master)
[020-021]	INTERRUPT CONTROLLER.(Master)
[022-023]	CHIPSET control registers. I/O ports.
[040-05F]	TIMER control registers.
[060-06F]	KEYBOARD interface controller.(8042)
[070-07F]	RTC ports & CMOS I/O ports.
[080-09F]	DMA register.
[0A0-0BF]	INTERRUPT controller.(Slave)
[0C0-0DF]	DMA controller.(Slave)
[0F0-0FF]	MATH COPROCESSOR.
[1F0-1F8]	HARD DISK controller.
[278-27F]	PARALLEL port 2.
[2B0-2DF]	GRAPHICS adapter controller.

[2F8-2FF]	SERIAL port 2.
[360-36F]	NETWORK ports.
[378-37F]	PARALLEL port 1.
[3B0-3BF]	MONOCHROME & PARALLEL port adapter.
[3C0-3CF]	EGA adapter.
[3D0-3DF]	CGA adapter.
[3F0-3F7]	FLOPPY DISK controller.
[3F8-3FF]	SERIAL port 1.

A-3 TIMER & DMA CHANNELS MAP

TIMER MAP:

TIMER Channel 0	System timer interrupt.
TIMER Channel 1	DRAM REFRESH request.
TIMER Channel 2	SPEAKER tone generator.

DMA CHANNELS:

DMA Channel 0	Available.
DMA Channel 1	Onboard ECP (Option).
DMA Channel 2	FLOPPY DISK (SMC CHIP).
DMA Channel 3	Onboard ECP (default).
DMA Channel 4	Cascade for DMA controller 1.
DMA Channel 5	Available.
DMA Channel 6	Available.
DMA Channel 7	Available

A-4 INTERRUPT MAP

NMI :

Parity check error.

IRQ (H/W):

0	System TIMER interrupt from TIMER 0.
1	KEYBOARD output buffer full.
2	Cascade for IRQ 8-15.
3	SERIAL port 2.
4	SERIAL port 1.
5	PARALLEL port 2.

6	FLOPPY DISK (SMC CHIP).
7	PARALLEL port 1.
8	RTC clock.
9	Available.
10	Available.
11	Available.
12	PS/2 Mouse.
13	MATH coprocessor.
14	Onboard HARD DISK (IDE1) channel.
15	Onboard HARD DISK (IDE1) channel.

A-5 RTC & CMOS RAM MAP

RTC & CMOS:

00	Seconds.
01	Second alarm.
02	Minutes.
03	Minutes alarm.
04	Hours.
05	Hours alarm.
06	Day of week.
07	Day of month.
08	Month.
09	Year.
0A	Status register A.
0B	Status register B.
0C	Status register C.
0D	Status register D.
0E	Diagnostic status byte.
0F	Shutdown byte.
10	FLOPPY DISK drive type byte.
11	Reserve.
12	HARD DISK type byte.
13	Reserve.
14	Equipment type.
15	Base memory low byte.

- 16 Base memory high byte.
- 17 Extension memory low byte.
- 18 Extension memory high byte.
- 19-2d
- 2E-2F
- 30 Reserved for extension memory low byte.
- 31 Reserved for extension memory high byte.
- 32 DATE CENTURY byte.
- 33 INFORMATION FLAG.
- 34-3F Reserve.
- 40-7F Reserved for CHIPSET SETTING DATA.

Appendix B

B-1 POST CODES

For BIOS 6.0 Code

POST (hex)	DESCRIPTION
CFh	Test CMOS R/W functionality.
C0h	Early chipset initialization: <ul style="list-style-type: none"> - Disable shadow RAM - Disable L2 cache (socket 7 or below) - Program basic chipset registers
C1h	Detect memory <ul style="list-style-type: none"> - Auto-detection of DRAM size, type and ECC. - Auto-detection of L2 cache (socket 7 or below)
C3h	Expand compressed BIOS code to DRAM
C5h	Call chipset hook to copy BIOS back to E000 & F000 shadow RAM.
0h1	Expand the Xgroup codes locating in physical address 1000:0
02h	Reserved
03h	Initial Superio_Early_Init switch.
04h	Reserved
05h	<ol style="list-style-type: none"> 1. Blank out screen 2. Clear CMOS error flag
06h	Reserved
07h	<ol style="list-style-type: none"> 1. Clear 8042 interface 2. Initialize 8042 self-test
08h	<ol style="list-style-type: none"> 1. Test special keyboard controller for Winbond 977 series Super I/O chips. 2. Enable keyboard interface.
09h	Reserved
0Ah	<ol style="list-style-type: none"> 1. Disable PS/2 mouse interface (optional). 2. Auto detect ports for keyboard & mouse followed by a port & interface swap (optional).

	3. Reset keyboard for Winbond 977 series Super I/O chips.
0Ch	Reserved
0Dh	Reserved
0Eh	Test F000h segment shadow to see whether it is R/W-able or not. If test fails, keep beeping the speaker.
0Fh	Reserved
10h	Auto detect flash type to load appropriate flash R/W codes into the run time area in F000 for ESCD & DMI support.
11h	Reserved
12h	Use walking 1's algorithm to check out interface in CMOS circuitry. Also set real-time clock power status, and then check for override.
13h	Reserved
14h	Program chipset default values into chipset. Chipset default values are MODBINable by OEM customers.
15h	Reserved
16h	Initial Early_Init_Onboard_Generator switch.
17h	Reserved
18h	Detect CPU information including brand, SMI type (Cyrix or Intel) and CPU level (586 or 686).
19h	Reserved
1Ah	Reserved
1Bh	Initial interrupts vector table. If no special specified, all H/W interrupts are directed to PURIOUS_INT_HDLR & S/W interrupts to SPURIOUS_soft_HDLR.
1Ch	Reserved
1Dh	Initial EARLY_PM_INIT switch.
1Eh	Reserved
1Fh	Load keyboard matrix (notebook platform)
20h	Reserved
21h	HPM initialization (notebook platform)
22h	Reserved
23h	<ol style="list-style-type: none">1. Check validity of RTC value: e.g. a value of 5Ah is an invalid value for RTC minute.2. Load CMOS settings into BIOS stack. If CMOS

- checksum fails, use default value instead.
3. Prepare BIOS resource map for PCI & PnP use. If ESCD is valid, take into consideration of the ESCD's legacy information.
 4. Onboard clock generator initialization. Disable respective clock resource to empty PCI & DIMM slots.
 5. Early PCI initialization:
 - Enumerate PCI bus number
 - Assign memory & I/O resource
 - Search for a valid VGA device & VGA BIOS, and put it into C000:0.
- 24h Reserved
- 25h Reserved
- 26h Reserved
- 27h Initialize INT 09 buffer
- 28h Reserved
- 29h
1. Program CPU internal MTRR (P6 & PII) for 0-640K memory address.
 2. Initialize the APIC for Pentium class CPU.
 3. Program early chipset according to CMOS setup.
Example: onboard IDE controller.
 4. Measure CPU speed.
 5. Invoke video BIOS.
- 2Ah Reserved
- 2Bh Reserved
- 2Ch Reserved
- 2Dh
1. Initialize multi-language
 2. Put information on screen display, including Award title, CPU type, CPU speed
- 2Eh Reserved
- 2Fh Reserved
- 30h Reserved
- 31h Reserved
- 32h Reserved
- 33h Reset keyboard except Winbond 977 series Super I/O chips.

34h	Reserved
35h	Reserved
36h	Reserved
37h	Reserved
38h	Reserved
39h	Reserved
3Ah	Reserved
3Bh	Reserved
3Ch	Test 8254
3Dh	Reserved
3Eh	Test 8259 interrupt mask bits for channel 1.
3Fh	Reserved
40h	Test 8259 interrupt mask bits for channel 2.
41h	Reserved
42h	Reserved
43h	Test 8259 functionality.
44h	Reserved
45h	Reserved
46h	Reserved
47h	Initialize EISA slot
48h	Reserved
49h	<ol style="list-style-type: none">1. Calculate total memory by testing the last double word of each 64K page.2. Program write allocation for AMD K5 CPU.
4Ah	Reserved
4Bh	Reserved
4Ch	Reserved
4Dh	Reserved
4Eh	<ol style="list-style-type: none">1. Program MTRR of M1 CPU2. Initialize L2 cache for P6 class CPU & program CPU with proper cacheable range.3. Initialize the APIC for P6 class CPU.4. On MP platform, adjust the cacheable range to smaller one in case the cacheable ranges between each CPU are not identical.
4Fh	Reserved
50h	Initialize USB

51h	Reserved
52h	Test all memory (clear all extended memory to 0)
53h	Reserved
54h	Reserved
55h	Display number of processors (multi-processor platform)
56h	Reserved
57h	1. Display PnP logo 2. Early ISA PnP initialization - Assign CSN to every ISA PnP device.
58h	Reserved
59h	Initialize the combined Trend Anti-Virus code.
5Ah	Reserved
5Bh	(Optional Feature) Show message for entering AWDFLASH.EXE from FDD (optional)
5Ch	Reserved
5Dh	1. Initialize Init_Onboard_Super_IO switch. 2. Initialize Init_Onboard_AUDIO switch.
5Eh	Reserved
5Fh	Reserved
60h	Okay to enter Setup utility; i.e. not until this POST stage can users enter the CMOS setup utility.
61h	Reserved
62h	Reserved
63h	Reserved
64h	Reserved
65h	Initialize PS/2 Mouse
66h	Reserved
67h	Prepare memory size information for function call: INT 15h ax=E820h
68h	Reserved
69h	Turn on L2 cache
6Ah	Reserved
6Bh	Program chipset registers according to items described in Setup & Auto-configuration table.
6Ch	Reserved

6Dh	<ol style="list-style-type: none">1. Assign resources to all ISA PnP devices.2. Auto assign ports to onboard COM ports if the corresponding item in Setup is set to "AUTO".
6Eh	Reserved
6Fh	<ol style="list-style-type: none">1. Initialize floppy controller2. Set up floppy related fields in 40:hardware.
70h	Reserved
71h	Reserved
72h	Reserved
73h	(Optional Feature) Enter AWDFLASH.EXE if : - AWDFLASH is found in floppy drive. - ALT+F2 is pressed
74h	Reserved
75h	Detect & install all IDE devices: HDD, LS120, ZIP, CDROM.....
76h	Reserved
77h	Detect serial ports & parallel ports.
78h	Reserved
79h	Reserved
7Ah	Detect & install co-processor
7Bh	Reserved
7Ch	Reserved
7Dh	Reserved
7Eh	Reserved
7Fh	<ol style="list-style-type: none">1. Switch back to text mode if full screen logo is supported.<ul style="list-style-type: none">- If errors occur, report errors & wait for keys- If no errors occur or F1 key is pressed to continue:<ul style="list-style-type: none">◆Clear EPA or customization logo.
80h	Reserved
81h	Reserved
82h	<ol style="list-style-type: none">1. Call chipset power management hook.2. Recover the text font used by EPA logo (not for full screen logo)3. If password is set, ask for password.
83h	Save all data in stack back to CMOS

84h	Initialize ISA PnP boot devices
85h	<ol style="list-style-type: none">1. USB final Initialization2. NET PC: Build SYSID structure3. Switch screen back to text mode4. Set up ACPI table at top of memory.5. Invoke ISA adapter ROMs6. Assign IRQs to PCI devices7. Initialize APM8. Clear noise of IRQs.
86h	Reserved
87h	Reserved
88h	Reserved
89h	Reserved
90h	Reserved
91h	Reserved
92h	Reserved
93h	Read HDD boot sector information for Trend Anti-Virus code
94h	<ol style="list-style-type: none">1. Enable L2 cache2. Program boot up speed3. Chipset final initialization.4. Power management final initialization5. Clear screen & display summary table6. Program K6 write allocation7. Program P6 class write combining
95h	<ol style="list-style-type: none">1. Program daylight saving2. Update keyboard LED & typematic rate
96h	<ol style="list-style-type: none">1. Build MP table2. Build & update ESCD3. Set CMOS century to 20h or 19h4. Load CMOS time into DOS timer tick5. Build MSIRQ routing table.
FFh	Boot attempt (INT 19h)

Page Left Blank

Appendix C

NOTE:

The "**LOAD Optimized DEFAULTS**" function loads the system default data directly from ROM and initializes the associated hardware properly. This function will be necessary when you accept this mainboard, or the system CMOS data is corrupted.

CMOS Setup Utility - Copyright (C) 1984-1998

Standard CMOS Feature	Frequency/Voltage Control
Advanced BIOS Feature	Load Fail-Safe Defaults
Advanced Chipset Feature	Load Optimized Defaults
Integrated Peripherals	Set Supervisor Password
Power Management S	<div style="border: 1px solid black; padding: 5px; display: inline-block;"> Load Optimized Defaults (Y/N)? Y </div>
PnP/PCI Configurati	
PC Health Status	Exit Without Saving
Esc : Quit ↑ ↓ ← → : Select Item	
F10 : Save & Exit Setup	
Time, Date, Hard Disk Type....	

LOAD Optimized DEFAULTS

Page Left Blank

Appendix D

D-1 GHOST 5.1 Quick User's Guide

Installation is very easy. You only need to copy the **Ghost5** folder or **Ghost.exe** to your hard disk.

The current market version is for single **Client**, so the LPT and NetBios portions will not be explained further.

Description of Menus

Ghost clones and backs up **Disk** and **Partition**.

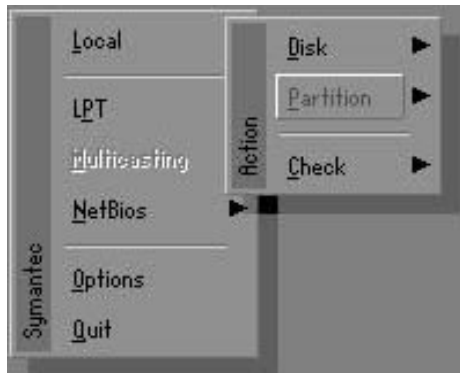

In which **Disk** indicates hard disk options
Partition indicates partition options
Check indicates check options

Disk

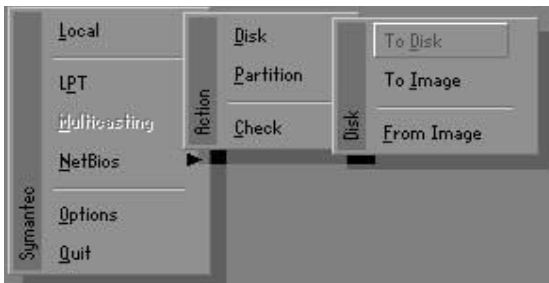

There are 3 hard disk functions:

1. Disk To Disk (disk cloning)
2. Disk To Image (disk backup)
3. Disk From Image (restore backup)

Important!

1. To use this function, the system must have at least 2 disks. Press the **Tab** key to move the cursor.
2. When restoring to a destination disk, all data in that disk will be completely destroyed.

Disk To Disk (Disk Cloning)

1. Select the location of the **Source drive**.
2. Select the location of the **Destination drive**.

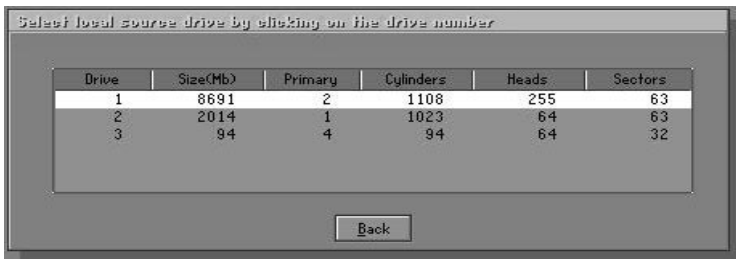

3. When cloning a disk or restoring the backup, set the required partition size as shown in the following figure.

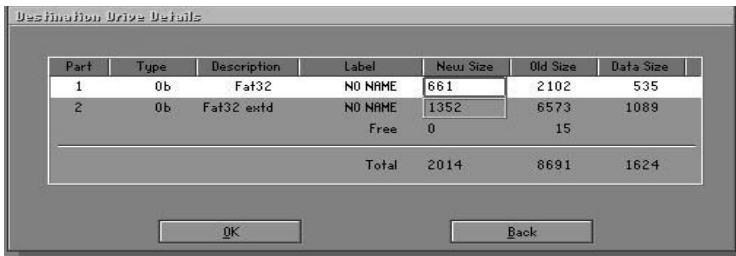

- Click OK to display the following confirmation screen. Select **Yes** to start.

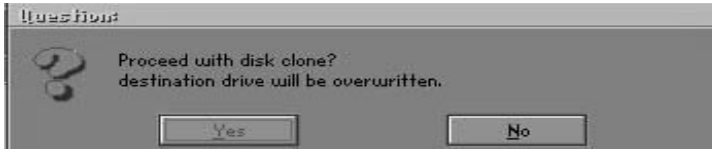

Disk To Image (Disk Backup)

- Select the location of the Source drive.

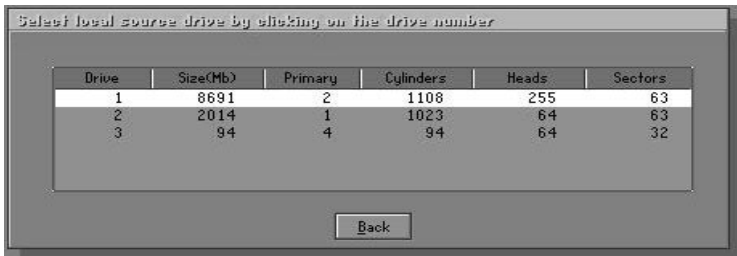

- Select the location for storing the backup file.

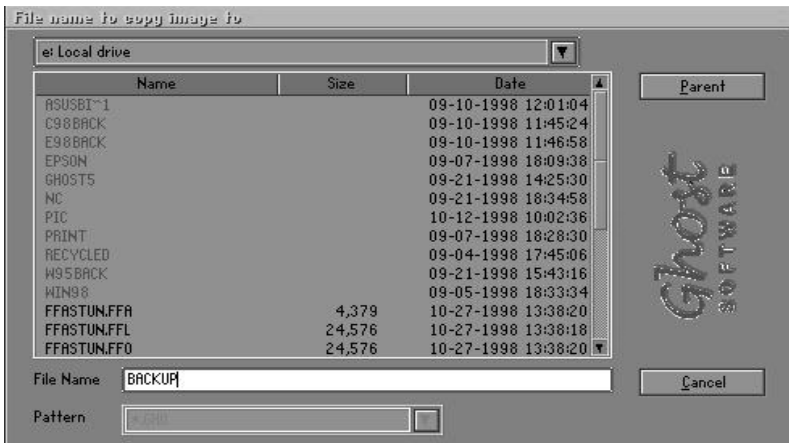

3. Click **OK** to display the following confirmation screen. Select **Yes** to start.

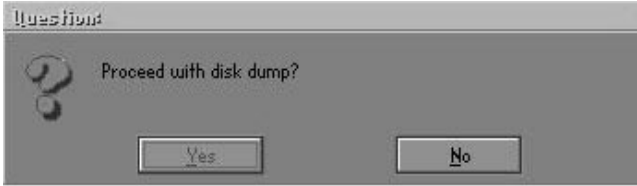

Disk From Image (Restore Backup)

1. Select the Restore file.

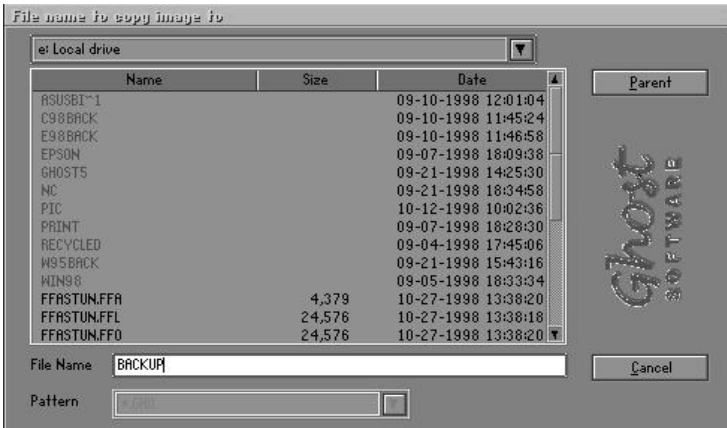

2. Select the **Destination drive** of the disk to be restored.

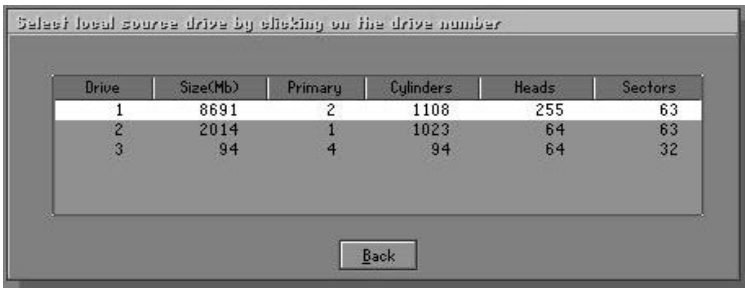

- 3. When restoring disk backup, set the required partition size as shown in the following figure.

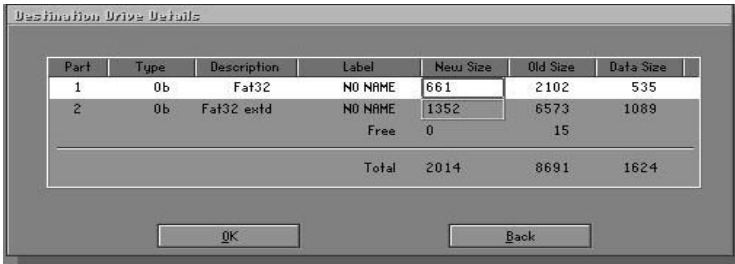

- 4. Click **OK** to display the following confirmation screen. Select **Yes** to start.

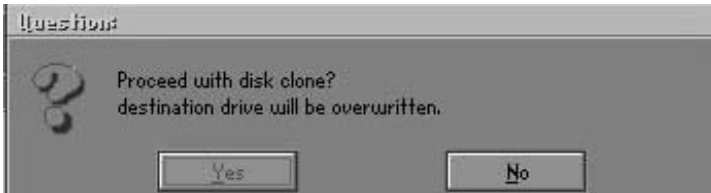

Partition

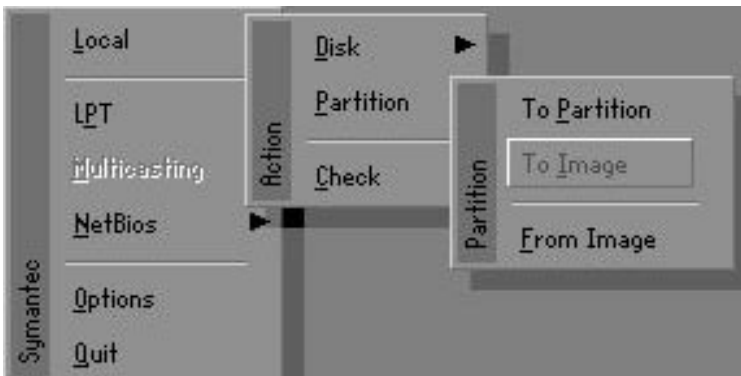

There are 3 partition functions:

1. **Partition To Partition** (partition cloning)
2. **Partition To Image** (partition backup)
3. **Partition From Image** (restore partition)

Partition To Partition (Partition Cloning)

The basic unit for partition cloning is a partition. Refer to disk cloning for the operation method.

Partition To Image (Partition Backup)

1. Select the disk to be backed up.

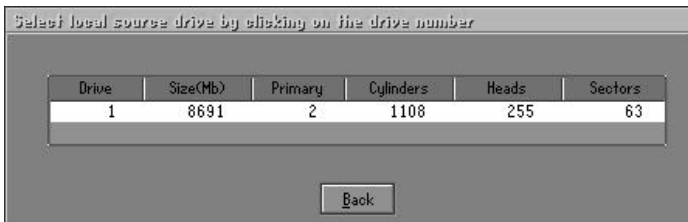

2. Select the first partition to be backed up. This is usually where the operating system and programs are stored.

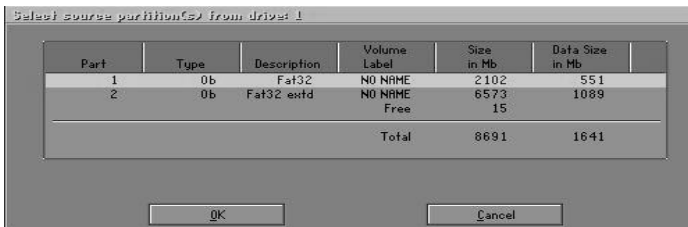

3. Select the path and file name for storing the backup file.

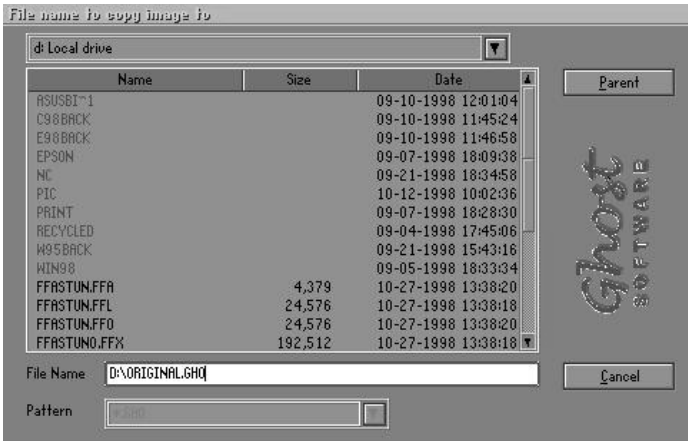

4. Is the file compressed? There are 3 options:

(1) No: do not compress data during backup

(2) Fast: Small volume compression

(3) High: high ratio compression. File can be compressed to its minimum, but this requires longer execution time.

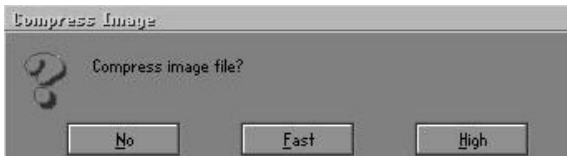

5. During confirmation, select Yes to start performing backup.



Partition From Image (Restore Partition)

1. Select the backup file to be restored.

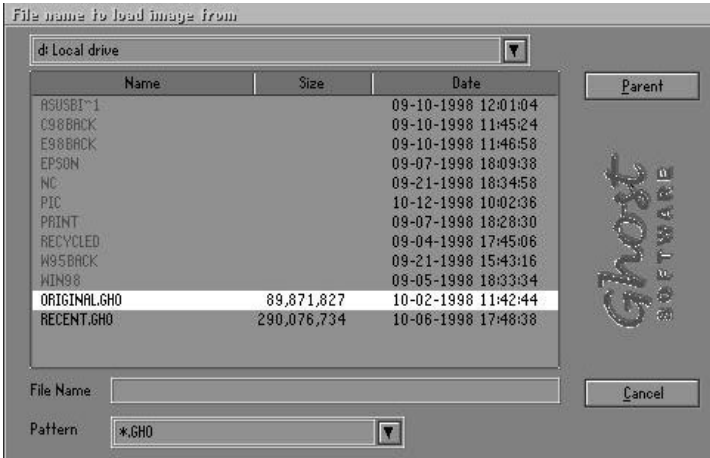

2. Select the source partition.

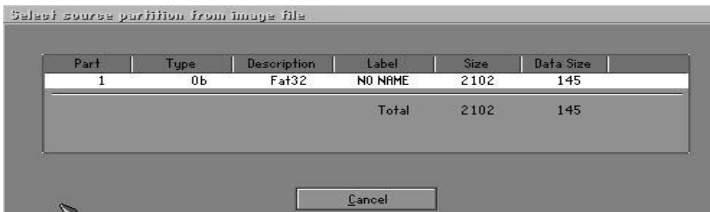

3. Select the disk to be restored.

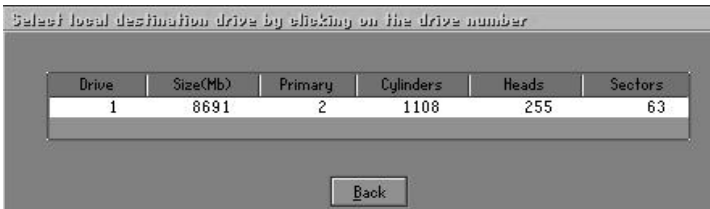

4. Select the partition to be restored.

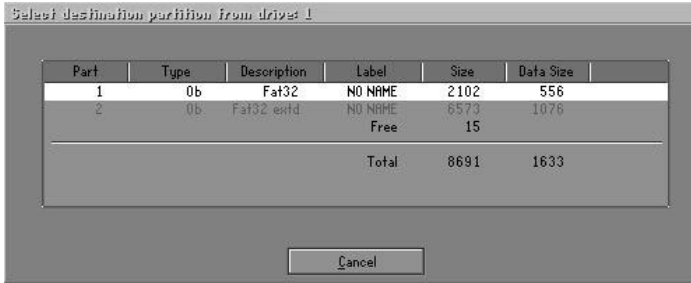

5. Select Yes to start restoring.

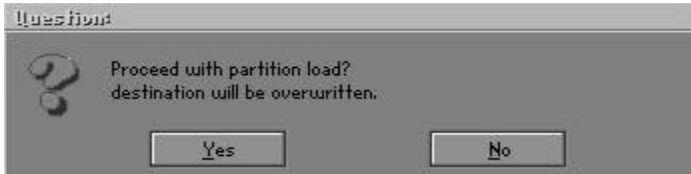

Check

This function checks the hard disk or backup file for backup or restoration error due to FAT or track error.