



# User's Manual

**An AMD Socket A Processor based  
mainboard (100/133MHz)**

**Supports PC1600/2100 Memory Modules**

## **TRADEMARK**

All products and company names are trademarks or registered trademarks of their respective holders.

*These specifications are subject to change without notice.*

*Manual Revision 1.4  
August 20, 2001*



---

# Table of Contents

---

	<i>Page</i>
<b>Section 1</b>	<b><i>Introduction</i></b>
	Components Checklist ..... 1-1
	<b><i>Overview</i></b>
	Terminology ..... 1-2
	System Overview ..... 1-3
	AMD Duron™ & Athlon™ Processors ..... 1-4
	Accelerated Graphics Port ..... 1-5
	Ultra ATA/66/100 ..... 1-5
	Hardware Monitoring ..... 1-5
	Mainboard Form-Factor ..... 1-6
	I/O Shield Connector ..... 1-7
	Power-On/Off (Remote) ..... 1-7
	System Block Diagram ..... 1-8
<b>Section 2</b>	<b><i>Features</i></b>
	Mainboard Features ..... 2-1
<b>Section 3</b>	<b><i>Installation</i></b>
	Mainboard Detailed Layout ..... 3-2
	<b><i>Easy Installation Procedure</i></b>
	CPU Insertion ..... 3-3
	EEPROM BIOS Remover ..... 3-5
	Jumper Settings ..... 3-5
	System Memory Configuration ..... 3-8
	Device Connectors ..... 3-10
	External Modem Ring-in Power ON and Keyboard Power ON Function (KBPO) ..... 3-13
	STR Function (Not Supported by HPT370A) ..... 3-15
	“POSTMAN” Function Introduction ..... 3-17

---

---

  
**Section 4****Award BIOS Setup**

BIOS Instructions .....	4-1
Standard CMOS Setup .....	4-3
Advanced BIOS Features .....	4-7
Advanced Chipset Features .....	4-10
Integrated Peripherals .....	4-13
Power Management Setup .....	4-17
PNP/PCI Configuration Setup .....	4-21
PC Health Status .....	4-23
Frequency/Voltage Control .....	4-24
Defaults Menu .....	4-25
Supervisor/User Password Setting .....	4-26
Exit Selecting .....	4-27

**Section 5****Driver Installation**

Easy Driver Installation .....	5-1
--------------------------------	-----

**Appendix****Appendix A**

Load Setup Defaults .....	A-1
---------------------------	-----

**Appendix B**

GHOST 5.1/6.03 Quick User's Guide .....	B-1
---	-----

**Appendix C**

POST Codes .....	C-1
------------------	-----

**Appendix D**

EEPROM BIOS Remover .....	D-1
---------------------------	-----

---



Section 1  
INTRODUCTION

Components Checklist

- ✓ A. (1) Mainboard
- ✓ B. (1) User's manual
- ✓ C. (1) Floppy ribbon cable
- ✓ D. (1) ATA-66/100 Hard drive ribbon cable
- ✓ E. (1) USB Cable
- ✓ F. (1) Driver and utility
- ✓ G. (1) ATA-33 Hard drive ribbon cable

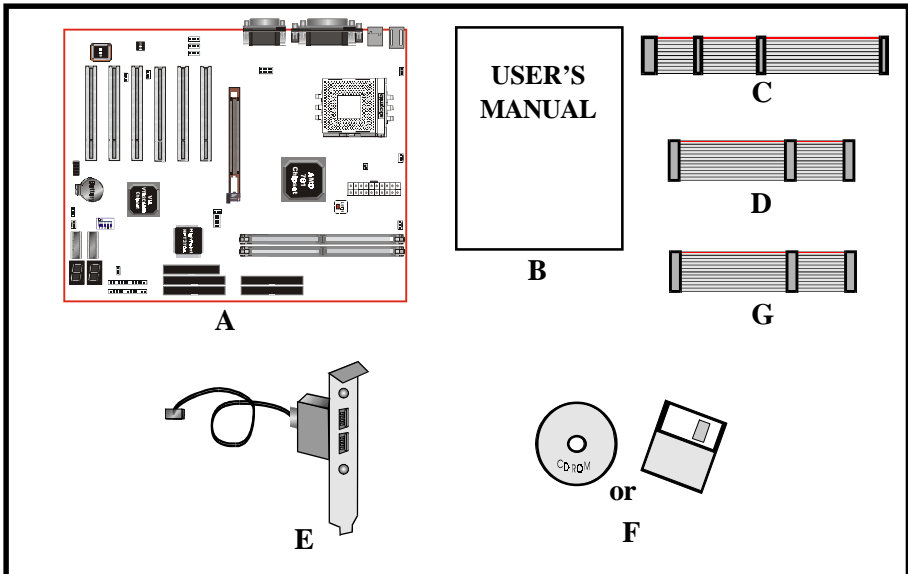

### Terminology

---

#### ◆ **Accelerated Graphics Port (AGP)**

The AGP interface that is in the AMD 761™, it supports a subset of 3.3V, 66MHz components, 3.3V 66/133 MHz AGP 2.0 compliant components, and the new 1.5V 66/266 MHz components.

#### ◆ **Socket A (Socket 462)**

The Socket connector that is similar Intel PGA 370 socket. Socket A has 462 pin sites to support AMD Duron™/Althon™ processor in PGA package.

#### ◆ **3DNow!™**

3DNow! technology enabled fast frame rates on high-resolution 3D rendered scenes, amazing physical modeling of real-world environments, sharp and detailed 3D imaging, smooth video playback, and theater-quality audio. The new enhanced 3DNow! technology implemented in the AMD Athlon processor adds streaming and digital signal processing (DSP) technologies, which allows faster, more accurate speech recognition, DVD-quality audio and video, and streaming audio and video for a rich Internet experience.

#### ◆ **DDR SDRAM**

The DDR (Double Data Rate) Synchronous SRAM employs high-speed, low-power CMOS designs. The DDR SRAM enables high performance operation through high clock frequencies (achieved through pipelining) and double data rate mode of operation in the system. Double data rate of SDRAM in which data is sent on both the rising and falling edges of clock cycle in a data burst.

#### ◆ **STR(Suspend-To-RAM)**

A lower power state than active. In the STR state, the system state is stored in main memory and all unnecessary system logic is turned off. Only main memory and logic required to wake the system remain powered.

### ◆ RAID, RAID 0+1, RAID 0, RAID 1

- RAID** Redundant Array of Independent Disks (RAID) refers to a method of organizing data on one or more physical disks to provide increased I/O performance and data protection. The different methods for organizing the data are referred to as RAID Levels. The RAID levels offered by HPT370A are 0,1 and 0+1.
- RAID0+1** A combination of RAID 1 and RAID 0. Provides high performance and high availability.
- RAID 0** Striping of data across multiple drives in an array. Very fast performance, however there is no data protection.
- RAID 1** Also known as mirroring. Mirroring refers to the 100% duplication of data from one disk to another. Due to the 100% duplication, this is a costly solution.

## System Overview

---

The board was developed by AMD-761 system controller (Northbridge) and VIA's VT82C686B (Southbridge) for the high-performance Socket A AMD Duron™/Althon™ processor-based.

The board is a four-layer, ATX form factor board. That supports a 200/266MHz (double clocked) front-side bus, 100/133MHz (or 200/266MHz clock rate) DDR SDRAM interface and supports AGP 2X and 4X, six PCI 32bit/33MHz slots, Suspend-to-RAM, and paired with VIA VT82C686B Southbridge to supports two bus mastering ATA 33/66/100 EIDE ports. Additionally an extra IDE port by HPT370A/Ultra DMA 66/100 & IDE RAID x 2 (Up to 4 Device) was supports too (HPT370A is optional). The IDE-RAID HPT370A supports RAID 0,1 and 0+1. This is idea for small businesses that need to mirror their servers to used IDE hard disk for a much cheaper solution than SCSI RAID. The board designs do not contain ISA slots. It supports a "POSTMAN" (optional) function and "80 Port" to deliver a easy way for the Power On Self Test (POST) code sending out a error messages via HuMANlike voice by the speaker and POST error code by the 7-segment LED on board.

Figure 5 Show a block digram for an AMD Duron™/Althon™ processor with DDR SDRAM-base system.

## Introduction

---

### AMD Duron™ & Athlon™ Processors

---

The AMD Athlon™ is a seventh-generation micro architecture with an integrated L2 cache, which is powerful enough to support the bandwidth requirements of a large range of applications, hardware, graphics, and memory technologies. These processors implement advanced design techniques such as:

- ◆ Socket A (PGA 462)
- ◆ 200 or 266MHz system interface based on the Alpha™ EV6 bus protocol.
- ◆ Three out-of-order, superscalar, pipelined Multimedia Units.
- ◆ Three out-of-order, superscalar, pipelined Integer Units.
- ◆ Fixed-sized internal instruction formats (MacroOPs).
- ◆ 72-entry Instruction Control Units.
- ◆ AMD enhanced 3DNow!™ technology
- ◆ L1 and L2 caches.
- ◆ Dynamic branch prediction.

Socket A is the name for AMD's new socketed interface designed to support both AMD Duron™ and AMD Athlon™ processors. This innovation is made possible by integrating the L2 cache memory on chip with the processor. Socket A will help enable smaller enclosures, and ultimately result in a wider variety of solutions in the market.

The AMD Duron™ & Athlon™ processors in the Socket A format continue to deliver the ultimate performance for cutting-edge applications. Both bring to desktop systems running industry-standard x86 software superscalar RISC performance. Being provided in the Socket A format they are the world's most powerful x86 processors. They easily deliver the highest integer, floating-point, and 3D multimedia performance for applications running on x86 platforms around.

The AMD Duron™ processor is derived from the AMD Athlon™ processor core. It features full-speed, on-chip cache memory, a 200MHz front side system bus, and enhanced 3DNow!™ technology. Although both processors are related, there are key differences. The AMD Athlon™ processor is targeted at the performance segment, and as such will have more cache memory and higher clock speeds.

### Accelerated Graphics Port (AGP or A.G.P.)

---

Typically, 3D graphics rendering requires a tremendous amount of memory, and demands ever increasing throughput speed as well. As 3D products for the personal computer become more and more popular, these demands will only increase. This will cause a rise in costs for both end users and manufacturers. Lowering these costs as well as improving performance is the primary motivation behind AGP. By providing a massive increase in the bandwidth available between the video card and the processor, it will assist in relieving some of these pressures for quite sometime.

### Ultra ATA/66/100

---

The board provides two channel (one channel is optional) Ultra ATA/66/100 Bus Master IDE controller, that support Ultra ATA/66/100 protocols, perfect for such demanding applications as real-time video, multimedia, and high performance operating system. A new IDE cable is required for Ultra ATA/66/100. This cable is an 80 conductor cable; however the connectors are, of course, backwards compatible with ATA/33.

### Hardware Monitoring

---

Hardware monitoring allows you to monitor various aspects of your systems operations and status. The features include CPU temperature, voltage and RPM of fan.

# Introduction

---

## Mainboard Form-Factor

---

The board is designed with ATX form factor - the new industry standard of chassis. ATX form factor is essentially a Baby-AT baseboard rotated 90 degrees within the chassis enclosure and a new mounting configuration for the power supply. With these changes the processor is relocated away from the expansion slots, allowing them all to hold full length add-in cards. ATX defines a double height aperture to the rear of the chassis which can be used to host a wide range of onboard I/O. Only the size and position of this aperture is defined, allowing PC manufacturers to add new I/O features (e.g.; TV input, TV output, joystick, modem, LAN, etc.) to systems. This will help systems integrators differentiate their products in the marketplace, and better meet your needs.

- Smaller size promotes a smaller system size.
- I/O shield does not need to be retooled in an ATX 2.01 or later. The mainboard should be used in an ATX 2.01 (or later) compliant case.
- A smaller power supply can be used. High integration on mainboard reduces the system costs.

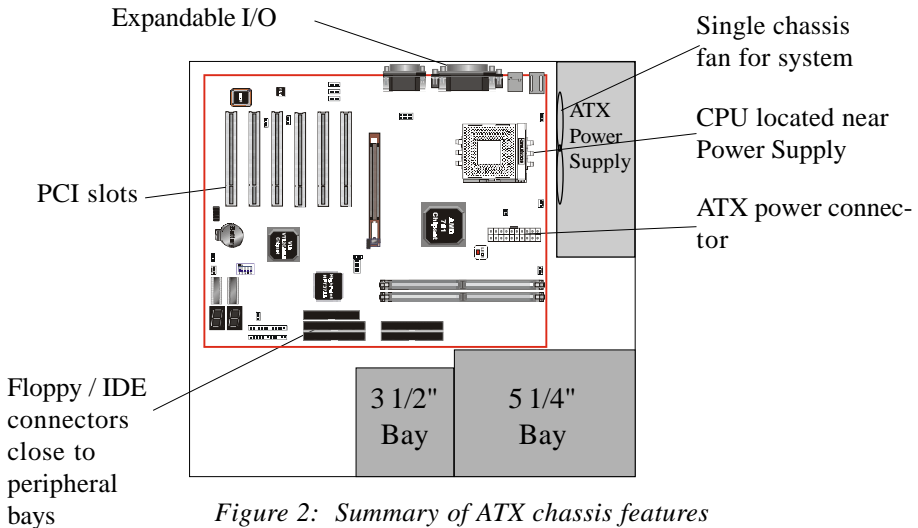

Figure 2: Summary of ATX chassis features

## I/O Shield Connector

The board is equipped with an I/O back panel. Please use the appropriate I/O shield (figure 3).

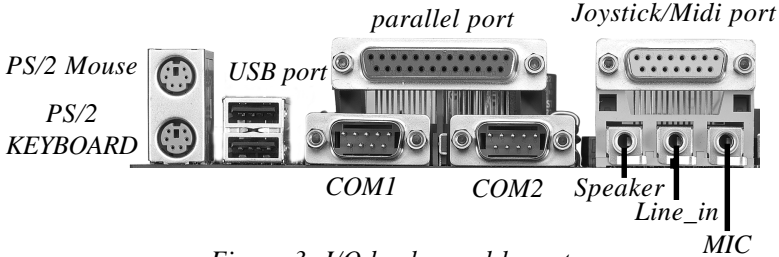

Figure 3: I/O back panel layout

## Power-On/Off (Remote)

The board has a single 20-pin connector for ATX power supplies. For ATX power supplies that support the **Remote On/Off** feature, this should be connected to the systems front panel for system Power On/Off button. The systems power On/Off button should be a momentary button that is normally open.

The board has been designed with "Soft Off" functions. You can turn Off the system from one of two sources: The first is the front panel Power On/Off button, and the other is the "Soft Off" function (coming from the M/B's onboard circuit controller) that can be controlled by the operating system such as Windows® 95/98/SE/ME or Windows® 2000.

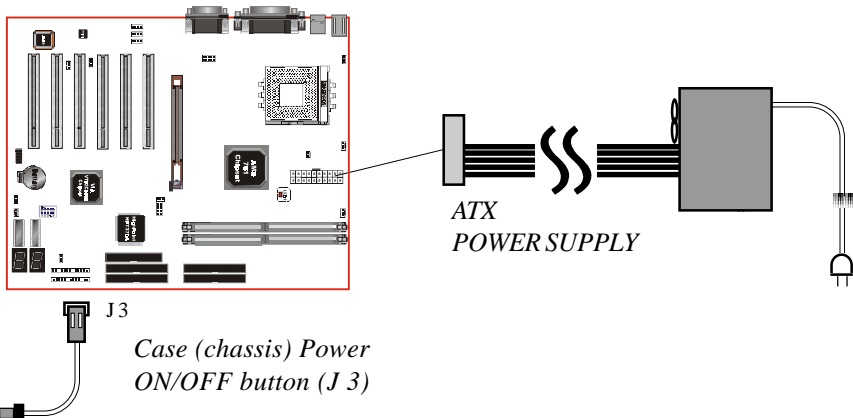

Figure 4: Simple ATX Power ON/OFF Controller

# Introduction

## System Block Diagram

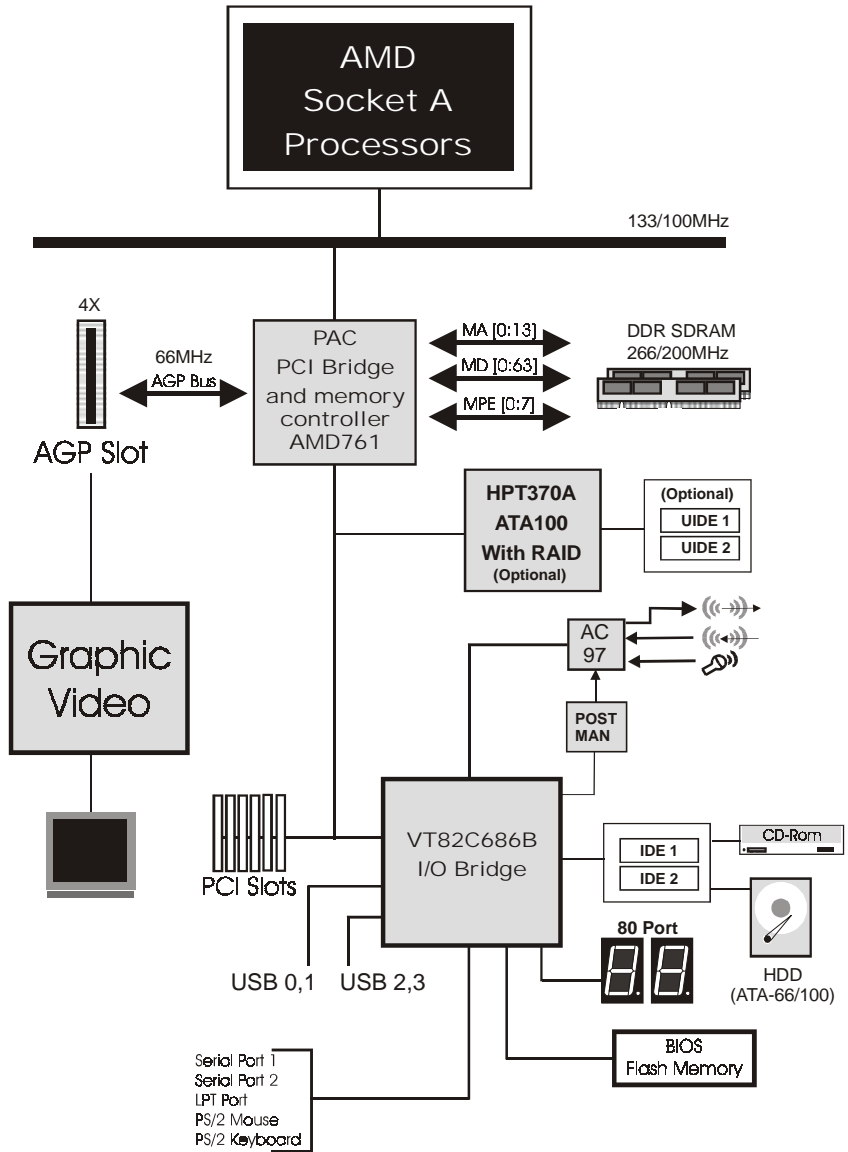

Figure 5: System Block Diagram



### Mainboard Features:

---

#### ◆ PROCESSOR

- AMD Athlon™, Duron™ Processors with a 200/266 MHz Host bus (100/133MHz x 2), Socket A, operating at 600MHz ~ 1.2GHz

#### ◆ CHIPSET

- AMD-760™ Chipset (AMD-761™ + VIA VT82C686B)

#### ◆ DDR SDRAM DIMM MODULE

- 184pin DDR DIMM x 2 for PC1600/2100 Memory
- DRAM Size: 64MB to 512MB

#### ◆ EXPANSION SLOT

- PCI x 6 (six PCI bus master), 4X AGP x 1

#### ◆ ONBOARD I/O

- On-Chip I/O integrated with K/B, Mouse, FDD, Parallel and Serial, Fast IR and Power-ON controllers

#### ◆ ONBOARD PCI / IDE

- PCI Bus IDE Port with PIO / Ultra DMA-66/100 x 2 (Up to 4 Devices)  
Extra IDE Port by HPT370A with Ultra DMA 66/100 & IDE RAID x 2 (Up to 4 Devices)(Optional)

#### ◆ I/O CONNECTOR

- PS/2 Mouse and PS/2 style Keyboard

#### ◆ USB

- USB connector x 4 (2 for Opt.)

## Features

---

### ◆ BIOS

- Award Plug & Play BIOS

### ◆ Built-in AC97 Digital Audio(by VT82C686B)

- Dual full-duplex Direct Sound channels
- H/W Sound Blaster Pro for DOS legacy compatibility
- FM synthesis for legacy compatibility
- Supports game and MIDI port

### ◆ EXTENDED FUNCTION

- Supports exclusive USDM (Unified System Diagnostic Manager) and Hardware Monitoring Function by VT82C686B
- Supports exclusive KBPO (KeyBoard Power On)
- Supports Wake-On-LAN Function
- Supports Wake-On-Modem Function
- Supports STR (Suspend To Ram) function
- Supports CPU Vcore & DDR Voltage settings via Jumper
- Supports CPU Clock & Multiplier settings via BIOS & Jumper
- 80 Port Debug(POST) Card onboard design with 7-segment LED display
- Supports POSTMAN(Power On Self Test with Human-like voice alarm) (Optional)

### ◆ FORM FACTOR

- 305mm x 245mm ATX Size

Section 3  
INSTALLATION

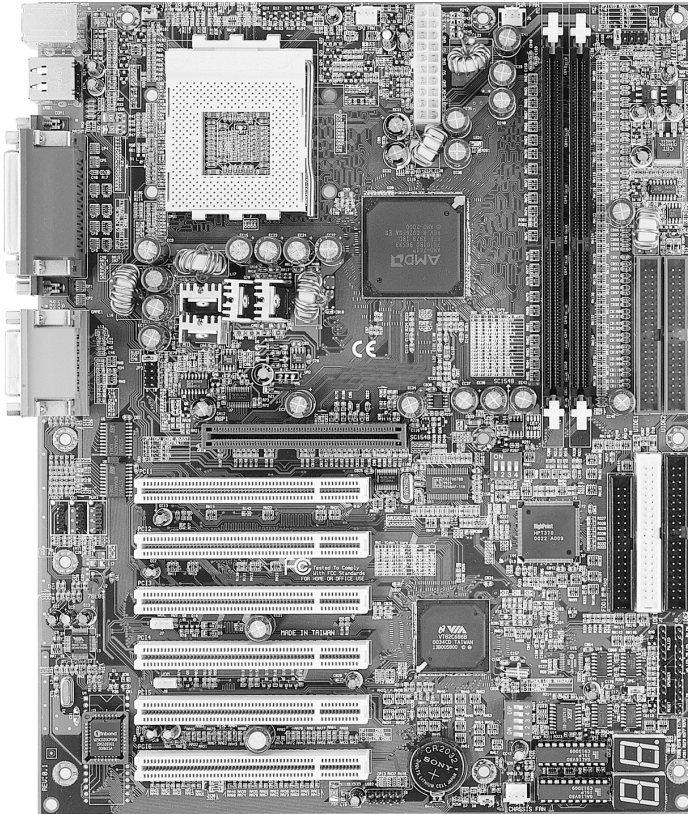

## Mainboard Detailed Layout

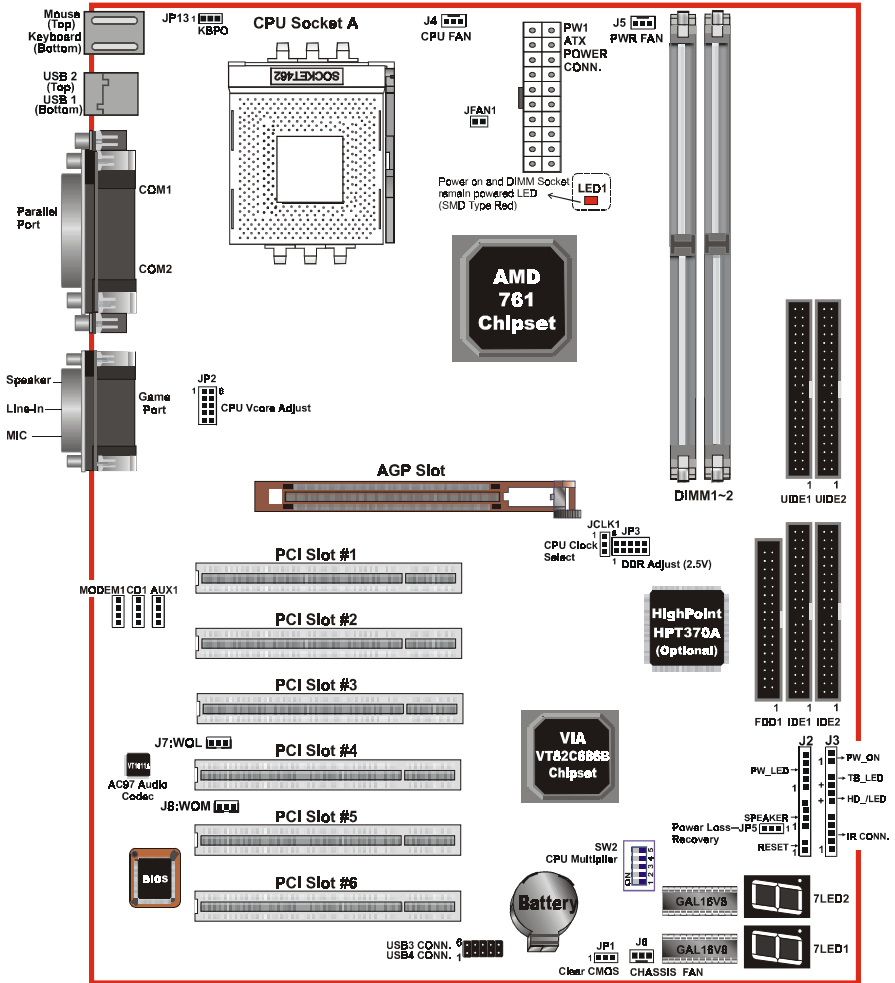

Figure 1

## Easy Installation Procedure

The following must be completed before powering on your new system:

- 3-1. CPU Insertion**
- 3-2. Jumper Settings**
- 3-3. System memory Configuration**
- 3-4. Device Connectors**
- 3-5. External Modem Ring-in Power ON and Keyboard Power ON Functions (KBPO)**
- 3-6. STR Function** (STR function is applicable to the ports of IDE1 and IDE2)
- 3-7. POSTMAN Function**

### Section 3-1 CPU Insertion

CPU Insertion: (use AMD Athlon™ as reference)

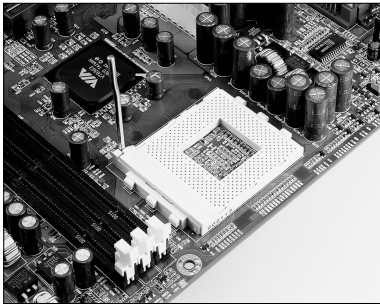

*Figure 2*

#### **Step 1**

Open the socket by raising the actuation lever.

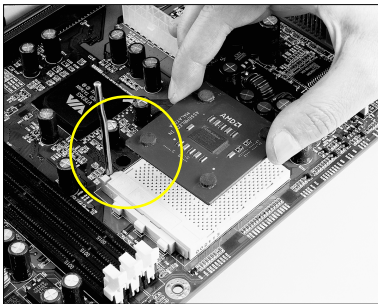

*Figure 3*

#### **Step 2**

Insert the processor.

Ensure proper pin 1 orientation by aligning the FC-PGA corner marking with the socket corner closest to the actuation arm tip. The pin field is keyed to prevent mis-oriented insertion.

Don't force processor into socket. If it does not go in easily, check for mis-orientation and debris. Make sure the processor is fully inserted into the socket on all sides.

## Installation

---

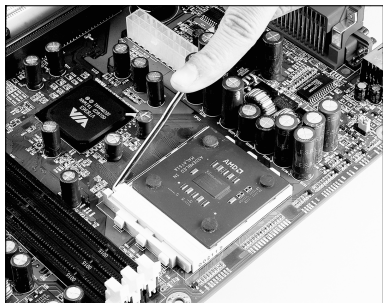

*Figure 4*

### Step 3

Close the socket by lowering and locking the actuation lever.

### Step 4

Thermal compound and qualified heatsink recommended by AMD are a must to avoid CPU overheat damage. For more information about installing your CPU, please refer to the AMD website article “Socket A AMD processor and Heatsink Installation Guide” <http://www.amd.com/products/cpg/athlon/pdf/23986.pdf>.

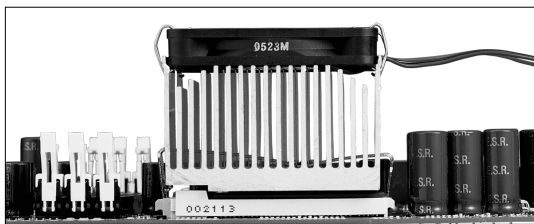

*Figure 5*

## Section 3-2 Jumper Settings

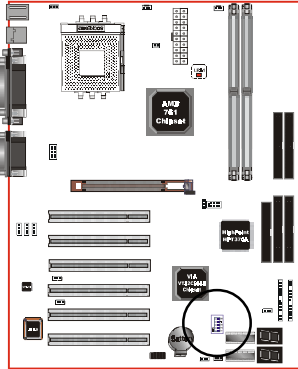

SW2: CPU Ratio Selection



SW2					CPU Ratio
1	2	3	4	5	
X	X	X	X	OFF	AUTO (Default)
ON	ON	ON	ON	ON	x 11
OFF	ON	ON	ON	ON	x 11.5
ON	OFF	ON	ON	ON	x 12
OFF	OFF	ON	ON	ON	x 12.5
ON	ON	OFF	ON	ON	x 5
OFF	ON	OFF	ON	ON	x 5.5
ON	OFF	OFF	ON	ON	x 6
OFF	OFF	OFF	ON	ON	x 6.5
ON	ON	ON	OFF	ON	x 7
OFF	ON	ON	OFF	ON	x 7.5
ON	OFF	ON	OFF	ON	x 8
OFF	OFF	ON	OFF	ON	x 8.5
ON	ON	OFF	OFF	ON	x 9
OFF	ON	OFF	OFF	ON	x 9.5
ON	OFF	OFF	OFF	ON	x 10
OFF	OFF	OFF	OFF	ON	x 10.5

X: don't care

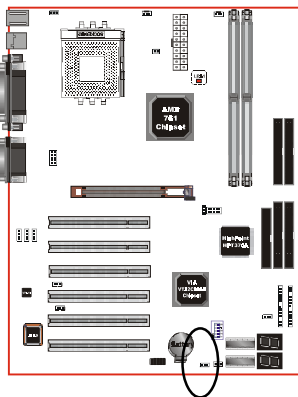

JP1



CMOS Clear

1-2 Normal (Default)

2-3 Clear CMOS

# Installation

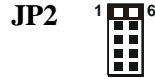
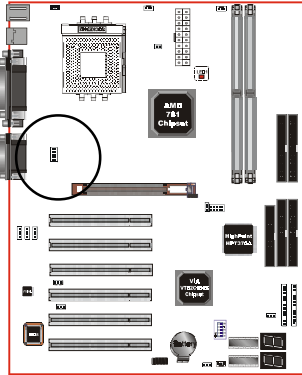

## CPU Vcore Adjust

JP2	CPU Vcore Adjust
1-6	+0.V (Default)
2-7	+0.1V
3-8	+0.2V
4-9	+0.3V
5-10	+0.4V

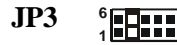
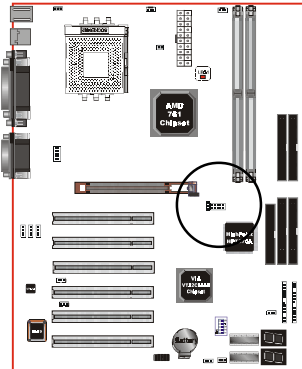

## DDR Adjust (2.5V)

JP3	DDR Adjust (2.5V)
1-6	+0.0V
2-7	+0.1V (Default)
3-8	+0.2V
4-9	+0.3V
5-10	+0.4V

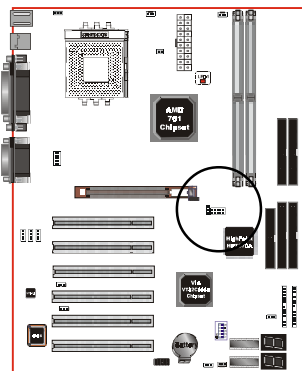

## CPU Clock Select

JCLK1	CPU	DDR	AGP	PCI
1-2 (Default)	100MHz	200MHz	66.6	33.3
2-3	133MHz	266MHz	66.6	33.3



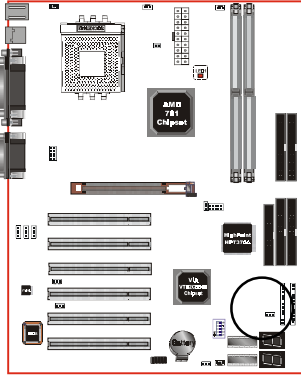

**JP5**



Power Loss Recovery  
1-2 Disabled (Default)  
2-3 Enabled

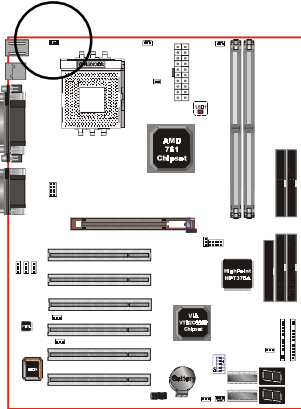

**JP13**



Keyboard Power On Function  
1-2 Disabled (Default)  
2-3 Enabled

# Installation

## Section 3-3 System Memory Configuration

### Memory Layout

The board supports (2) PC1600/2100 184-pin DIMMs (Dual In-line Memory Module). The DIMMs is for DDR SDRAM (Double-Data-Rate Synchronous DRAM) only.

- DDR SDRAM support 200MHz at AMD Athlon™/Duron™ 100MHz front-side bus or 266MHz at AMD Athlon™/Duron™ 133MHz front-side bus.
- Supports Memory Error Correcting Code (ECC).
- Supports 64Mbit, 128Mbit, 256Mbit and 512Mbit technology.
- 64-bit data width, plus & 8 bit ECC paths.
- Supports up to two unbuffered DDR DIMMs or two registered DIMMs.
- Supports up to 1Gbytes of memory.

Figure 6 and Table 1 show several possible memory configurations.



Figure 6

Total Memory	DDR DIMM 1 (Bank 0/1)	DDR DIMM 2 (Bank 2/3)
= 512MB Maximum	DDR SDRAM* 64MB, 128MB, 256MB, 512MB X 1	None
= 1GB Maximum	DDR SDRAM* 64MB, 128MB, 256MB, 512MB X 1	DDR SDRAM* 64MB, 128MB, 256MB, 512MB X 1

Table 1

- \* *DDR SDRAM supports 64, 128, 256, 512MB DIMM modules.*
- \* *We recommend using PC1600 Memory Module only for front-side bus 100MHz.*
- \* *DO NOT MIX the unbuffered and registered DDR SDRAM on DIMM1 and DIMM2 socket.*
- \* *Supports PC1600 modules with 2-2-2 timing.*
- \* *Supports PC2100 modules with 2-2-2 timing.*

## DIMM Module Installation

Figure 7 displays the notch marks and what they should look like on your DDR DIMM memory module.

DIMMs have 168-pins and one notch that will match with the onboard DDR DIMM socket. DIMM modules are installed by placing the chip firmly into the socket at a 90 degree angle and pressing straight down (figure 8) until it fits tightly into the DIMM socket (figure 9).

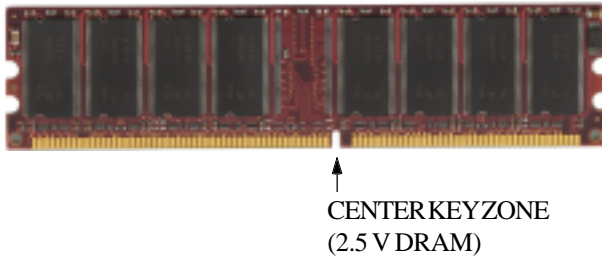

Figure 7

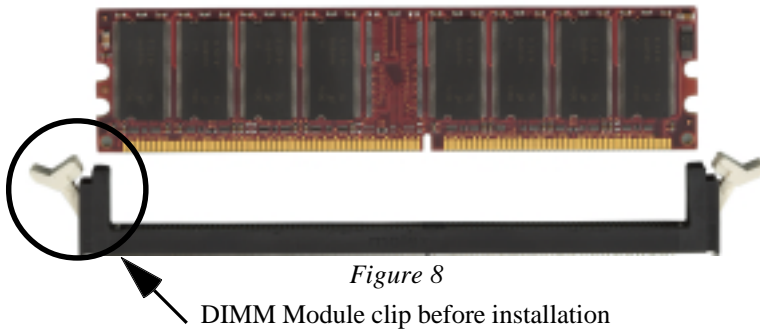

Figure 8

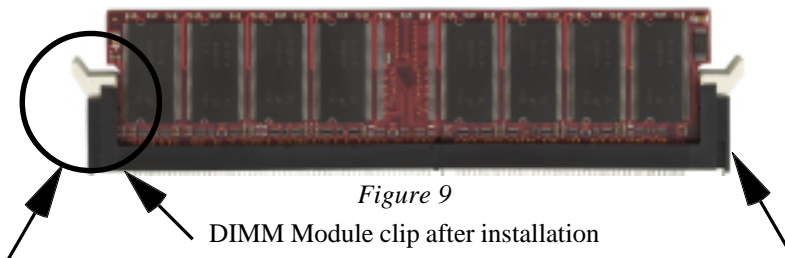

Figure 9

To remove the DIMM module simply press down both of the white clips on either side and the module will be released from the socket.

# Installation

---

## Section 3-4 Device Connectors

---

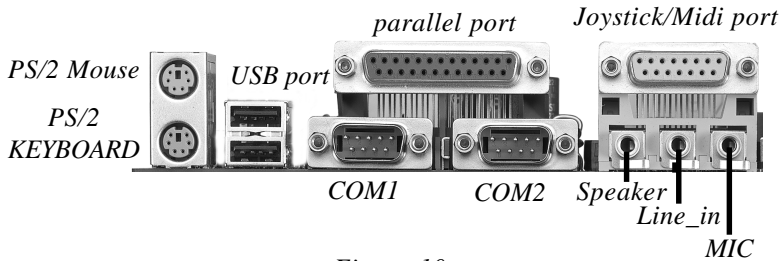

Figure 10

**J2,J3:** Chassis Panel Connector

- Power\_LED, Speaker, Reset, Power ON/Off, Turbo LED, HDD LED, IR Conn.,

**J4:** CPU Fan Power

- A plug-in for the CPU Fan Power

**J5:** Power Fan Power

- A plug-in for the Power Supply Fan Power

**J6:** Chassis Fan Power

- A plug-in for the chassis Fan Power

**J7:** WOL (Wake On Lan) Connector

**J8:** WOM (Wake On Modem) Connector

**IDE1:** Ultra ATA-66/100 Primary IDE Connector (supported by 686B chipset)  
(Blue Color)

**IDE2:** Ultra ATA-66/100 Secondary IDE Connector (supported by 686B chipset)  
(Blue Color)

**UIDE1:** Ultra ATA-66/100&RAID Primary IDE Connector (supported by HPT370A  
chipset) (Blue Color)(Optional)

**UIDE2:** Ultra ATA-66/100&RAID Secondary IDE Connector (supported by HPT370A  
chipset) (Blue Color)(Optional)

**FDD1:** Floppy Controller Connector (Black Color)

**PW1:** ATX Power Connector

- 20-pin power connector

**CD1:** CD Audio\_IN Connector

- Pin1(CD\_IN\_Left), Pin2/Pin3(CD\_Reference), Pin4(CD\_IN\_Right)

**AUX1:** Auxiliary Line\_IN Connector

- Pin1(Left Line\_IN), Pin2/Pin3(GND), Pin4(Right Line-IN)

**MODEM1:** Telephony Connector for Modem audio output

- Pin1(Audio\_in), Pin2/Pin3(GND), Pin4(Mic-out to Modem)

**USB2:** USB port header pins for adding two additional USB ports.

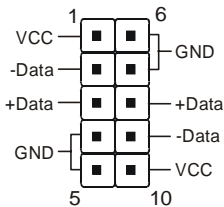

USB port header pin descriptions.

PIN#	Wire color	Signal Name	Comment
1	Red	Vcc	Cable Power
2	White	-Data	Data
3	Green	+Data	Data
4	Black	Ground	Cable Ground
5	Black	Ground	Case Ground
6	Black	Ground	Case Ground
7	Black	Ground	Cable Ground
8	Green	+Data	Data
9	White	-Data	Data
10	Red	Vcc	Cable Power

# Installation

---

## Device Connectors (continued)

(This is connected to the power button on the case. Using the Soft-Off by Pwr-BTTN feature, you can choose either Instant Off (turns system off immediately), or 4 sec delay (you need to push the button down for 4 seconds before the system turns off). When the system is in 4 sec delay mode, suspend mode is enabled by pushing the button momentarily.)

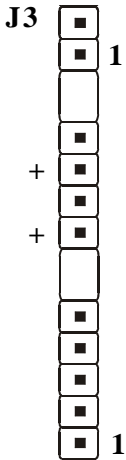

### Power On/Off

**Turbo LED indicator** - LED ON when higher speed is selected

**IDE LED indicator** - LED ON when Onboard PCI IDE Hard disks is activate

### IR Connector

- |         |         |
|---------|---------|
| 1. VCC  | 4. GND  |
| 2. NC   | 5. IRTX |
| 3. IRRX |         |

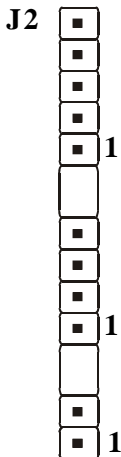

### Power LED - Power LED and S3 LED connector

- |                 |        |
|-----------------|--------|
| 1. Power LED(+) | 4. NC  |
| 2. N/C          | 5. GND |
| 3. GND          |        |

**Speaker** - Connect to the system's speaker for beeping

- |            |        |
|------------|--------|
| 1. Speaker | 3. GND |
| 2. N/C     | 4. GND |

**Reset** - Closed to restart system.

## Section 3-5 External Modem Ring-in Power ON and Keyboard Power ON Functions (KBPO)

---

On the basis of bounded functions in I/O chipset, the two serial ports are able to support the External Modem Ring-in Power ON function. Once users connect the external modem to COM1 or COM2, the mainboard allows users to turn on their system through the remote and host's dial-up control.

### Exclusive Keyboard Power ON Function

To innovate a unique feature to benefit users, we devoted the easiest and most convenient way to turn on your system based on the the ATX power supply.

How to work with it

**Step 1:** Please check JP13 at the position 2-3 after you finished the system installation.

JP13  Keyboard Power On Function  
1-2 Disabled (Default)  
2-3 Enabled

The diagram shows a rectangular component with three pins. The first pin is connected to the second pin, and the second pin is connected to the third pin. A small number '1' is positioned below the first pin.

**Step 2:** Push the momentary switch (J3 PW-ON) to turn on your system and then push again to hold for more than 4 seconds to turn it off after counting memory as soon as you turn it on.

**Step 3:** You can enjoy the Keyboard Power ON function (KBPO) by pressing *any key* to turn on your system. Your system will be turned on automatically, after releasing the keys. To power off you system, you can use the Soft-OFF function under Windows® 95/98 or Windows®2000.

## Installation

---

### Notes:

1. Intel ATX version 2.0 specification recommended you use the power supply with  $\geq 1.0A$  in 5.0VSB. With our mainboard, *the 5.0VSB standby power only has to be  $\geq 0.1A$  (100mA)* then you can enjoy this unique benefit. However, an ATX power supply which is  $< 0.1A$  (100mA) is still useable to your system by placed JP13 at the position 1-2 to disable this feature.
2. We recommended you use the power supply with 1.0A in 5.0VSB. Because this supported PCI 2.1 specification for remote power-on and wake-up function.



### 3-6 STR (Suspend To RAM) Function

The board supports the STR power management state by maintaining the appropriate states on the DDR SDRAM interface signals. The power source must be kept alive to the DDR SDRAM during STR (ACPI S3). Advanced Configuration Power Interface (ACPI) provides more Energy Saving Features for operating systems that supporting Instant ON and QuickStart™ function.

1. To enable the ACPI function and use the STR functionally to save your system energy, you are recommended to confirm the following requirements:
  - a. Please do install all ACPI qualified add-on cards such as AGP, LAN, Modem cards.
  - b. In BIOS, please select “ACPI function: Enable” and “ACPI Suspend Type: S3(STR)” in the Power Management Setup menu.
  - c. Then, please install the Windows® 98SE/ME or Windows® 2000.
  - d. Restart your system.
  - e. Getting in to the “Advanced” of the Power Management icon of Control Panel, and selecting the “Stand By” in the Power Buttons.
2. Getting start with STR function, please click the START button and choose Shut Down. Then, select the Stand By option in the Shut Down Windows box to get into STR mode.

Here are the differences between STR power saving mode and Green (or Suspend) mode:

- a. It is the most advanced Power Management mode
- b. It cuts all the power supplied to peripherals except to Memory - max. power saving
- c. It saves and keeps all on-screen data including any executed applications to DDR SDRAM.
- d. You must push the Power button connected with onboard J3 pin to wake up you system (not to click to mouse or press keyboard to wake up the system).

## Installation

---

Just pushing Power button, your system will quickly back to the last screen for you.

The “LED Indicator for ACPI Status” table shown below will guide you and give you a reference for ACPI status on this mainboard.

<b>ACPI Onboard's LED Status Indicator Table</b>					
Onboard's LED Location	Status				
	Plug in the ATX Power Core	Power ON J3(PW-ON)	Green Mode (S1)	STR (S3)	Shutdown (Soft-OFF) (S5)
LED1 (Red LED)	OFF	ON	ON	ON	OFF
J2 PW_LED	OFF	ON	Blinking	Blinking	OFF

### 3-7 “POSTMAN” Function Introduction (Optional)

---

With the board also make our initial premier of the new “**POSTMAN**” debug function. This new feature designed to enhance the Power On Self Test (POST) introduces a huMANlike voice with helpful debugging/error messages. So in the event the system experiences boot up difficulties “POSTMAN” will deliver the message in an easier to understand method than traditional POSTcodes. Such as, “SDRAM Detect Fail” for memory missing, memory install improperly or memory broken and “VGA Fail” for AGP card missing, AGP card install improperly or AGP card broken.

The voice could be pronounced through either an internal speaker or external speakers plugged into Line Out connector for a clear sound.

The messages recorded for this function are listed below for your reference while having problems with system boot up.

0. SDRAM Detect Fail
1. BIOS ROM Checksum Fail
2. Keyboard or PS/2 Mouse Fail
3. VGA Fail
4. Clock Generator or Overclock Fail
5. NO CPU Fan
6. Over Voltage Fail
7. SMBUS Fail
8. System boot OK
9. CPU, BIOS or Power Cable plug in abnormal



---

## Section 4 BIOS SETUP

---

### Main Menu

Once you enter the AwardBIOS™ CMOS Setup Utility, the Main Menu will appear on the screen. The Main Menu allows you to select from several setup functions and two exit choices. Use the arrow keys to select among the items and press <Enter> to accept and enter the sub-menu.

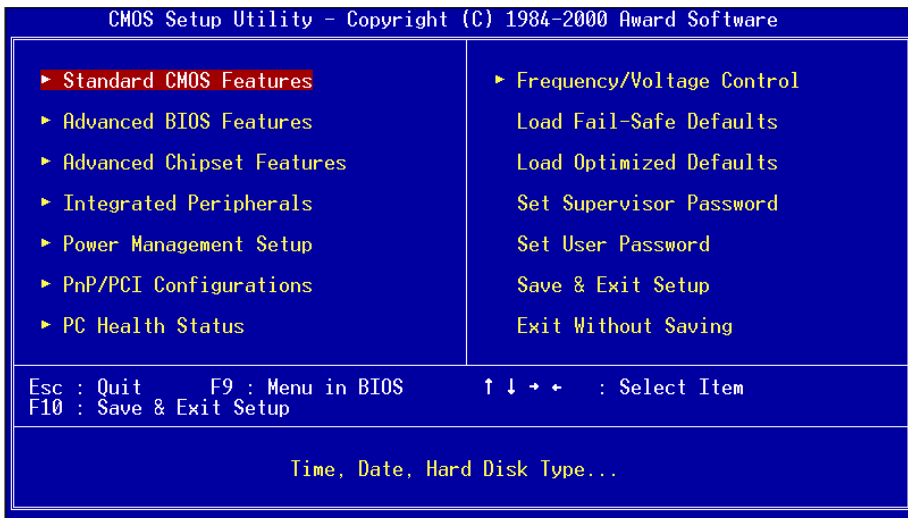

Note that a brief description of each highlighted selection appears at the bottom of the screen.

### **Setup Items**

The main menu includes the following main setup categories. Recall that some systems may not include all entries.

#### **Standard CMOS Features**

Use this menu for basic system configuration.

# BIOS

---

## **Advanced BIOS Features**

Use this menu to set the Advanced Features available on your system.

## **Advanced Chipset Features**

Use this menu to change the values in the chipset registers and optimize your system's performance.

## **Integrated Peripherals**

Use this menu to specify your settings for integrated peripherals.

## **Power Management Setup**

Use this menu to specify your settings for power management.

## **PnP / PCI Configuration**

This entry appears if your system supports PnP / PCI.

## **PC Health Status**

This item is only show the system health status (include Voltage, Fan speed, CPU temperature...)

## **Frequency/Voltage Control**

Use this menu to specify your settings for frequency/voltage control.

## **Load Fail-Safe Defaults**

Use this menu to load the BIOS default values for the minimal/stable performance for your system to operate.

## **Load Optimized Defaults**

Use this menu to load the BIOS default values that are factory settings for optimal performance system operations. While Award has designed the custom BIOS to maximize performance, the factory has the right to change these defaults to meet their needs.

## **Supervisor / User Password**

Use this menu to set User and Supervisor Passwords.

## **Save & Exit Setup**

Save CMOS value changes to CMOS and exit setup.

## **Exit Without Save**

Abandon all CMOS value changes and exit setup.

## 4-1 Standard CMOS Setup

The items in Standard CMOS Setup Menu are divided into 10 categories. Each category includes no, one or more than one setup items. Use the arrow keys to highlight the item and then use the <PgUp> or <PgDn> keys to select the value you want in each item.

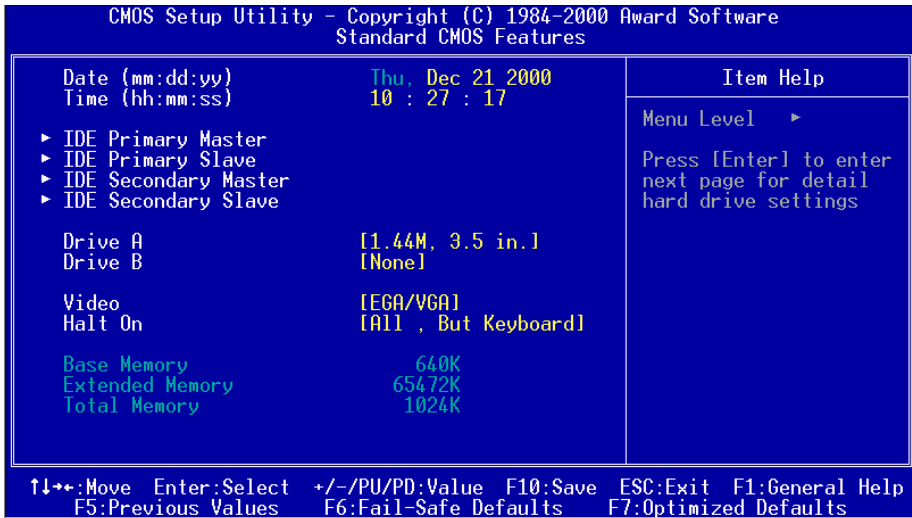

Figure 1: The Main Menu

## Main Menu Selections

This table shows the selections that you can make on the Main Menu

<b>Item</b>	<b>Options</b>	<b>Description</b>
Date	Month DD YYYY	Set the system date. Note that the 'Day' automatically changes when you set the date
Time	HH : MM : SS	Set the system time
IDE Primary Master	Options are in its sub menu (described in Table 3)	Press <Enter> to enter the sub menu of detailed options
IDE Primary Slave	Options are in its sub menu (described in Table 3)	Press <Enter> to enter the sub menu of detailed options
IDE Secondary Master	Options are in its sub menu (described in Table 3)	Press <Enter> to enter the sub menu of detailed options
IDE Secondary Slave	Options are in its sub menu (described in Table 3)	Press <Enter> to enter the sub menu of detailed options
Drive A Drive B	None 360K, 5.25 in 1.2M, 5.25 in 720K, 3.5 in 1.44M, 3.5 in 2.88M, 3.5 in	Select the type of floppy disk drive installed in your system
Video	EGA/VGA CGA 40 CGA 80 MONO	Select the default video device
Halt On	All Errors No Errors All, but Keyboard All, but Diskette All, but Disk/Key	Select the situation in which you want the BIOS to stop the POST process and notify you
Base Memory	N/A	Displays the amount of conventional memory detected during boot up
Extended Memory	N/A	Displays the amount of extended memory detected during boot up
Total Memory	N/A	Displays the total memory available in the system

*Table 2 Main Menu Selections*



## IDE Adapters

The IDE adapters control the hard disk drive. Use a separate sub menu to configure each hard disk drive.

Figure 2 shows the IDE primary master sub menu.

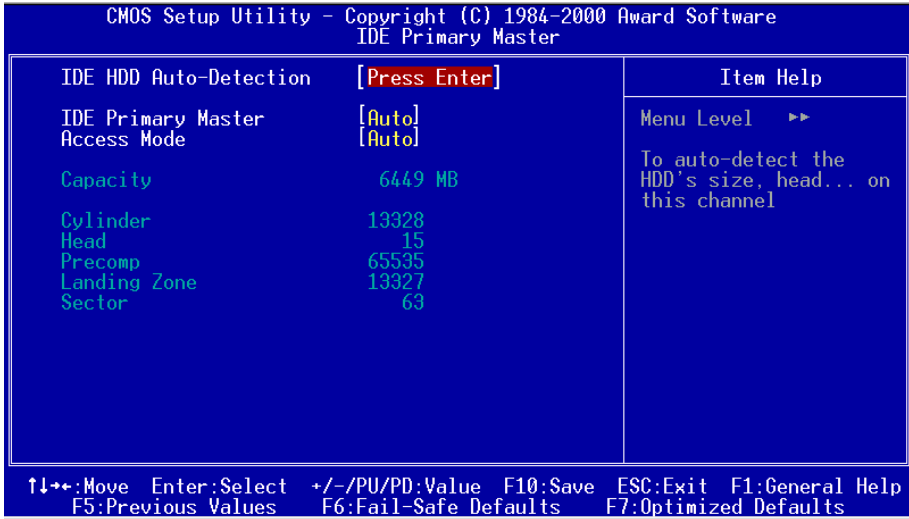

*Figure 2 IDE Primary Master sub menu*

# BIOS

---

Use the legend keys to navigate through this menu and exit to the main menu. Use Table 3 to configure the hard disk.

<i>Item</i>	<i>Options</i>	<i>Description</i>
IIDE HDD Auto-detection	Press Enter	Press Enter to auto-detect the HDD on this channel. If detection is successful, it fills the remaining fields on this menu.
IDE Primary Master	None Auto Manual	Selecting 'manual' lets you set the remaining fields on this screen. Selects the type of fixed disk. "User Type" will let you select the number of cylinders, heads, etc. Note: PRECOMP=65535 means NONE !
Capacity	Auto Display your disk drive size	Disk drive capacity (Approximated). Note that this size is usually slightly greater than the size of a formatted disk given by a disk checking program.
Access Mode	Normal LBA Large Auto	Choose the access mode for this hard disk
The following options are selectable only if the 'IDE Primary Master' item is set to 'Manual'		
Cylinder	Min = 0 Max = 65535	Set the number of cylinders for this hard disk.
Head	Min = 0 Max = 255	Set the number of read/write heads
Precomp	Min = 0 Max = 65535	**** <b>Warning:</b> Setting a value of 65535 means no hard disk
Landing zone	Min = 0 Max = 65535	****
Sector	Min = 0 Max = 255	Number of sectors per track

*Table 3 Hard disk selections*

## 4-2 Advanced BIOS Features

This section allows you to configure your system for basic operation. You have the opportunity to select the system's default speed, boot-up sequence, keyboard operation, shadowing and security.

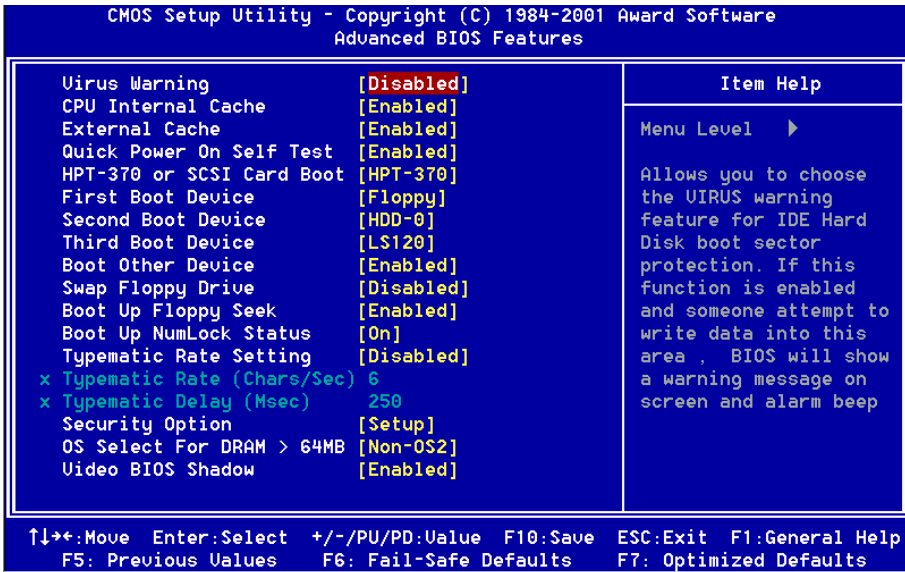

### Virus Warning

Allows you to choose the VIRUS Warning feature for IDE Hard Disk boot sector protection. If this function is enabled and someone attempt to write data into this area, BIOS will show a warning message on screen and alarm beep.

Enabled: Activates automatically when the system boots up causing a warning message to appear when anything attempts to access the boot sector or hard disk partition table.

Disabled: No warning message will appear when anything attempts to access the boot sector or hard disk partition table.

### CPU Internal Cache/External Cache

These two categories speed up memory access. However, it depends on CPU/chipset design.

The choice: Enabled/Disabled.

# BIOS

---

## **Quick Power On Self Test**

This category speeds up Power On Self Test (POST) after you power up the computer. If it is set to Enable, BIOS will shorten or skip some check items during POST.

Enabled: Enable quick POST

Disabled: Normal POST

## **HPT-370 or SCSI Card Boot**

Setup the boot up priority either from onboard HPT-370 connector or SCSI Card, if you select SCSI as the first boot device at the option below.

## **First/Second/Third/Other Boot Device**

The BIOS attempts to load the operating system from the devices in the sequence selected in these items.

The Choice: Floppy, LS120, HDD-0, SCSI, CDROM, HDD-1, HDD-2, HDD-3, ZIP100, LAN, Disabled.

## **Swap Floppy Drive**

If the system has two floppy drives, you can swap the logical drive name assignments.

The choice: Enabled/Disabled.

## **Boot Up Floppy Seek**

Seeks disk drives during boot up. Disabling speeds boot up.

The choice: Enabled/Disabled.

## **Boot Up NumLock Status**

Select power on state for NumLock.

The choice: On/Off.

## **Typematic Rate Setting**

Key strokes repeat at a rate determined by the keyboard controller. When enabled, the typematic rate and typematic delay can be selected.

The choice: Enabled/Disabled.

## **Typematic Rate (Chars/Sec)**

Sets the number of times a second to repeat a key stroke when you hold the key down.

The choice: 6, 8, 10, 12, 15, 20, 24, 30.

**Typematic Delay (Msec)**

Sets the delay time after the key is held down before it begins to repeat the keystroke. The choice: 250, 500, 750, 1000.

**Security Option**

Select whether the password is required every time the system boots or only when you enter setup.

**System**    The system will not boot and access to Setup will be denied if the correct password is not entered at the prompt.

**Setup**     The system will boot, but access to Setup will be denied if the correct password is not entered at the prompt.

*Note: To disable security, select PASSWORD SETTING at Main Menu and then you will be asked to enter password. Do not type anything and just press <Enter>, it will disable security. Once the security is disabled, the system will boot and you can enter Setup freely.*

**OS Select For DRAM > 64MB**

Select the operating system that is running with greater than 64MB of RAM on the system. The choice: Non-OS2, OS2.

**Video BIOS Shadow**

This option allows video BIOS to be copied into RAM. Video Shadowing will increase the video performance of your system.

The default is Enabled.

The choice: Enabled/Disabled.

## 4-3 Advanced Chipset Features

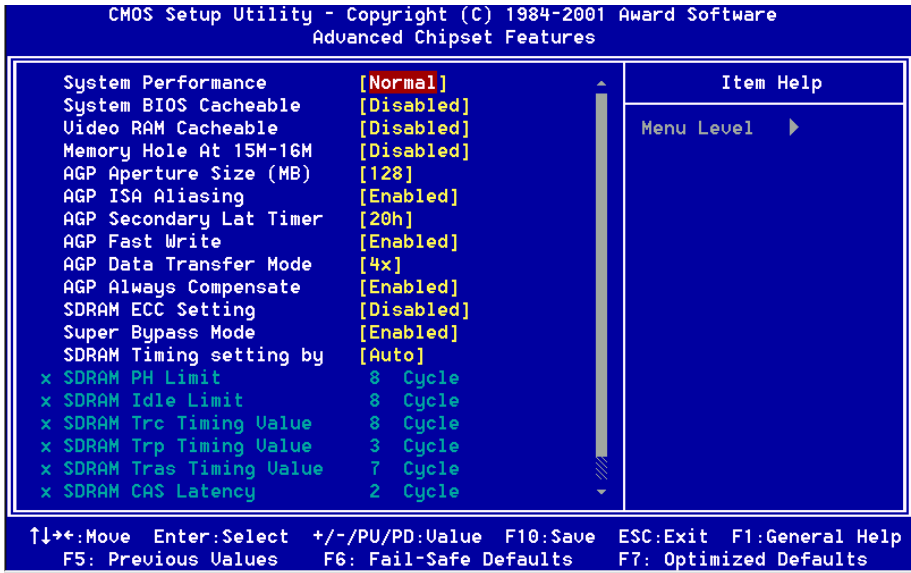

This section allows you to configure the system based on the specific features of the installed chipset. This chipset manages bus speeds and access to system memory resources, such as DRAM and the external cache. It also coordinates communications between the conventional ISA bus and the PCI bus. It must be stated that these items should never need to be altered. The default settings have been chosen because they provide the best operating conditions for your system. The only time you might consider making any changes would be if you discovered that data was being lost while using your system.

### System Performance

This item will help you to configure your system performance quickly and easily. There are two selections. When a selection is made, the other related items will automatically vary values.

The Choice: Normal, Fast.

*Note: If you select the higher performance, compatibility problem could be occurred.*

**System BIOS Cacheable**

Selecting *Enabled* allows caching of the system BIOS ROM at F0000h-FFFFFh, resulting in better system performance. However, if any program writes to this memory area, a system error may result.

The choice: Enabled, Disabled.

**Video RAM Cacheable**

This option allows the CPU to cache read/writes of the video RAM. The default is Disabled

Enabled: This option allows for faster video access.

Disabled: Reduced video performance.

**Memory Hole At 15M-16M**

You can reserve this area of system memory for ISA adapter ROM. When this area is reserved, it cannot be cached. The user information of peripherals that need to use this area of system memory usually discusses their memory requirements.

The Choice: Enabled, Disabled.

**AGP Graphics Aperture Size (MB)**

The amount of system memory that the AGP card is allowed to share. The default is 128.

32: 32MB of systems memory accessible by the AGP card.

64: 64MB of systems memory accessible by the AGP card.

128: 128MB of systems memory accessible by the AGP card.

256: 256MB of systems memory accessible by the AGP card.

**AGP ISA Aliasing**

You can reserve this item for more compatibility with ISA VGA.

The Choice: Enabled, Disabled.

**AGP Secondary Lat Timer**

Adhere to definition of the latency timer in the PCI Local Bus Specification, Revision 2.2 but only applies to the secondary interface of a PCI-to PCI bridge.

The Choice: 00h, 20h, 40h, 60h, 80h, C0h, FFh.

**AGP Fast Write**

Select Enabled allows to use Fast Write Protocol for 4X AGP.

The Choice: Enabled, Disabled.

# BIOS

---

## **AGP Data transfer Mode**

Chipset AGP Mode support

The Choice: 1x/2x, 4x

## **AGP Always Compensate**

When Enable dynamic compensation is performance by AGP on an ongoing basis at regular intervals this will make more compitibility with AGP VGA.

The Choice: Enabled, Disabled.

## **SDRAM ECC Setting**

Use this option to configurate the type of DRAM in your system.

The Choice: Disabled, Check Only, Correct Errors, Correct+Scrub.

## **Super Bypass Mode**

When Enable the AMD-761 system controller internally bypasses certain memory pipe stages for optional performance.

The Choice: Enabled, Disabled.

## **SDRAM Timing Setting By**

For setting DRAM timing, By Auto is follow Intel PC SDRAM Serial Presence Detect Specification.

The Choice: Auto, Manual.

## **SDRAM PH Limit**

This item control the number of consecutive page hit request to allow before choosing a non-PH request.

The Choice: 1, 4, 8, 16 cycle.

## **SDRAM Idle Limit**

This item control the number of idle cycle to wait before precharging on idle bank.

The Choice: 0, 8, 12, 16, 24, 32, 48 cycle.

## **SDRAM Trc Timing Value**

This item indicates the Trc timing value (bank cycle time: minimum time from activate to activate of same bank).

The Choice: 3, 4, 5, 6, 7, 8, 9, 10 cycle.



**SDRAM Trp Timing Value**

This item indicates the Trp timing value (precharge time: time from precharge to activate on the same bank).

The Choice: 3, 2, 1, 4 cycle.

**SDRAM Tras Timing Value**

This item indicates the Tras timing value (minimum bank active time: time from activate to precharge on the same bank).

The Choice: 2, 3, 4, 5, 6, 7, 8, 9 cycle.

**SDRAM CAS Latency**

When synchronous DRAM is installed, the number of clock cycles of CAS latency depends on the DRAM timing.

The Choice: 2, 2.5 cycle.

**SDRAM Trcd Timing Value**

This item indicates the Trcd timing value (RAS to CAS latency delay from activate to RD/WR command).

The Choice: 2, 3, 4, 5, 6, 7, 8, 9 cycle.

## 4-4 Integrated Peripherals

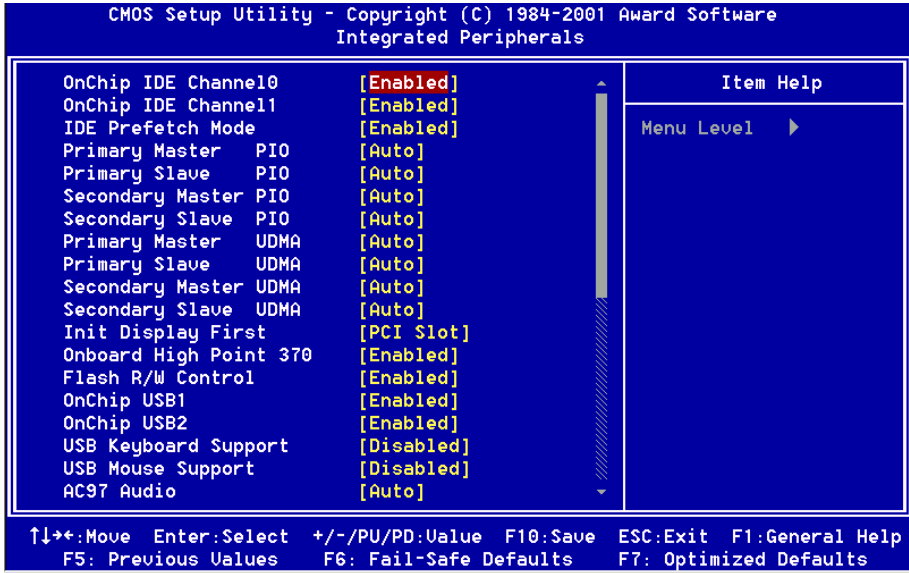

### OnChip Primary/Secondary PCI IDE

The integrated peripheral controller contains an IDE interface with support for two IDE channels. Select *Enabled* to activate each channel separately.

The choice: Enabled, Disabled.

### IDE Prefetch Mode

Enable prefetching for IDE drive interfaces that support its faster drive accesses. If you are getting disk drive errors, change the setting to omit the drive interface where the errors occur. Depending on the configuration of your IDE subsystem, this field may not appear, and it does not appear when the Internal PCI/IDE field, above, is Disabled.

The Choice: Enabled, Disabled.

### Primary/Secondary Master/Slave PIO

The four IDE PIO (Programmed Input/Output) fields let you set a PIO mode (0-4) for each of the four IDE devices that the onboard IDE interface supports. Modes 0 through 4 provide successively increased performance. In Auto mode, the system automatically determines the best mode for each device.

The choice: Auto, Mode 0, Mode 1, Mode 2, Mode 3, Mode 4.

**Primary/Secondary Master/Slave UDMA**

Ultra DMA/33 implementation is possible only if your IDE hard drive supports it and the operating environment includes a DMA driver (Windows 95 OSR2 or a third-party IDE bus master driver). If your hard drive and your system software both support Ultra DMA/33, select Auto to enable BIOS support.

The Choice: Auto, Disabled.

**Init Display First**

This item allows you to decide to active whether PCI Slot or on-chip VGA first  
The choice: PCI Slot, Onboard .

**Onboard High Point 370**

This item can control on board PCI device High Point 370 to enable or disable.  
The Choice: Enabled, Disabled.

**Flash R/W Control**

The Choice: Enabled, Disabled.

**OnChip USB1/2**

This should be enabled if your system has a USB installed on the system board and you want to use it. Even when so equipped, if you add a higher performance controller, you will need to disable this feature.

The choice: Enabled, Disabled.

**USB Keyboard/Mouse Support**

Select *Enabled* if your system contains a Universal Serial Bus (USB) controller and you have a USB Legacy Device (Keyboard, Mouse).

The choice: Enabled, Disabled.

**AC97 Audio**

This item allows you to decide to Auto or disable the chipset family to support AC97 Audio.

The function setting AC97 Audio Codec states. The system default is Auto.

**IDE HDD Block Mode**

Block mode is also called block transfer, multiple commands, or multiple sector read/write. If your IDE hard drive supports block mode (most new drives do), select Enabled for automatic detection of the optimal number of block read/writes per

# BIOS

---

sector the drive can support.

The choice: Enabled, Disabled

## **Onboard FDD Controller**

Select Enabled if your system has a floppy disk controller (FDC) installed on the system board and you wish to use it. If you install and-in FDC or the system has no floppy drive, select Disabled in this field.

The choice: Enabled, Disabled.

## **Onboard Serial Port 1/Port 2**

Select an address and corresponding interrupt for the first and second serial ports.

The choice: 3F8/IRQ4, 2E8/IRQ3, 3E8/IRQ4, 2F8/IRQ3, Disabled.

## **UART 2 Mode**

This field allows the users to configure what IR mode the 2nd serial port should use.

The default is Standard.

Optional: Standard, HPSIR and ASKIR.

## **Onboard Parallel port**

This field allows the user to configure the LPT port.

The default is 378H / IRQ7.

378H: Enable Onboard LPT port and address is 378H and IRQ7.

278H: Enable Onboard LPT port and address is 278H and IRQ5.

3BCH: Enable Onboard LPT port and address is 3BCH and IRQ7.

Disabled: Disable Onboard LPT port.

## **Parallel Port Mode**

This field allows the user to select the parallel port mode.

The default is EPP+ECP.

Normal: Standard mode. IBM PC/AT Compatible bidirectional parallel port.

EPP: Enhanced Parallel Port mode.

ECP: Extended Capabilities Port mode.

EPP+ECP: ECP Mode & EPP Mode.

## **ECP Mode USE DMA**

This field allows the user to select DMA1 or DMA3 for the ECP mode.

The default is DMA3.

DMA1: This field selects the routing of DMA1 for the ECP mode.

DMA3: This field selects the routing of DMA3 for the ECP mode.

**Parallel Port EPP Type**

This item allows you to determine the IR transfer mode of onboard I/O chip.  
options: EPP1.9, EPP1.7.

**Onboard Legacy Audio**

Legacy Audio enabled/disabled.

**Sound Blaster**

Sound Blaster compatible device enabled/disabled.

**SB I/O Base Address**

Sound Blaster I/O resource selection.

**SB IRQ Select**

Legacy audio device IRQ selection.

**SB DMA Select**

Sound Blaster DMA channel selection.

**MPU-401**

MPU-401 function enabled/disabled.

**MPU-401 I/O Address**

Built-in MPU-401 compatible MIDI I/O port selection:

The Choice: 300-303H, 310-313H, 320-323H, 330-333H (default)

**Game Port (200-207H)**

Built-in joystick port support disabled/enabled(default).

## 4-5 Power Management Setup

The Power Management Setup allows you to configure your system to most effectively save energy while operating in a manner consistent with your own style of computer use.

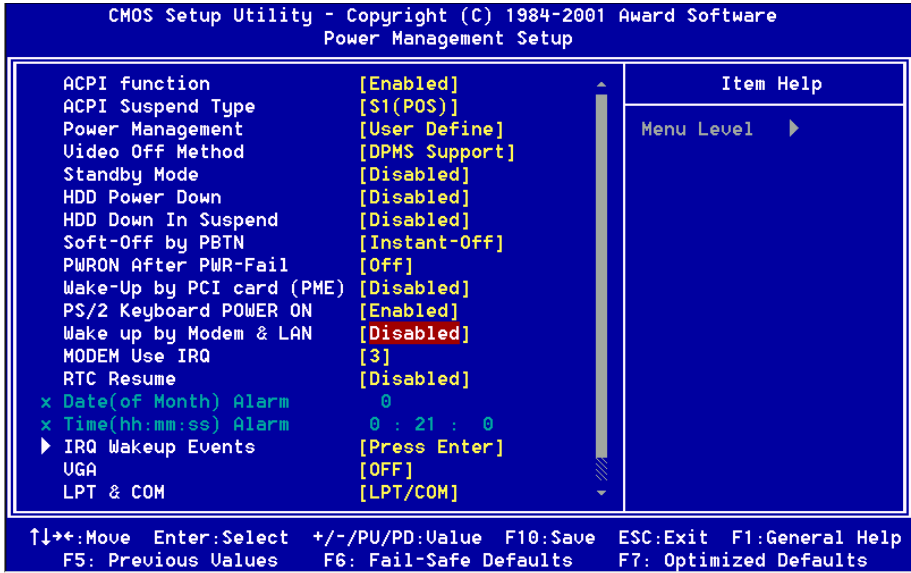

### ACPI Function

This item allows you to enable/disable the Advanced Configuration and Power Management (ACPI).

The choice: Enabled, Disabled.

### ACPI Suspend Type

This item allows you to select S1(POS) or S3(STR) function.

The choice: S1(POS), S3(STR).

### Power Management

This category allows you to select the type (or degree) of power saving and is directly related to the following modes:

1. HDD Power Down
2. Doze Mode
3. Suspend Mode

There are four selections for Power Management, three of which have fixed mode settings.

Disable (default)	No power management. Disables all four modes
Min. Power Saving	Minimum power management. Doze Mode = 1 hr. Standby Mode = 1 hr., Suspend Mode = 1 hr., and HDD Power Down = 15 min.
Max. Power Saving	Maximum power management -- <b>ONLY AVAILABLE FOR SL CPU's</b> . Doze Mode = 1 min., Standby Mode = 1 min., Suspend Mode = 1 min., and HDD Power Down = 1 min.
User Defined	Allows you to set each mode individually. When not disabled, each of the ranges are from 1 min. to 1 hr. except for HDD Power Down which ranges from 1 min. to 15 min. and disable.

### Video Off Method

This determines the manner in which the monitor is blanked.

V/H SYNC+Blank	This selection will cause the system to turn off the vertical and horizontal synchronization ports and write blanks to the video buffer.
Blank Screen	This option only writes blanks to the video buffer.
DPMS	Initial display power management signaling.

### Standby Mode

When the standby mode timer times-out, it will enter the standby mode and retain CPU at a slow working speed. The screen will be blanked out.

The choice: Disabled, 30sec, 1min, 4min, 20min, 30min, 1 hour.

### HDD Power Down

When enabled and after the set time of system inactivity, the hard disk drive will be powered down while all other devices remain active.

The choice: Enabled, Disabled.

### HDD Down In Suspend

The choice: Enabled, Disabled.

### Soft-Off by PWR-BTTN

Pressing the power button for more than 4 seconds forces the system to enter the Soft-Off state when the system has "hung." The default is Instant-off.

The choice: Delay 4 Sec, Instant-Off.

# BIOS

---

## **PWRON After PW-Fail**

The system will stay off or power on after a power interrupte.

The default is OFF.

Fomer-Status: Stay off or power on depend on system safe shut-down or power fail.

ON: System always power on after a power interrupte.

OFF: System always stay off after a power interrupte.

## **Wake-UP by PCI Card (PME)**

An input signal from PME on the PCI card awakens the system from a soft off state.

The choice: Enabled, Disabled.

## **PS/2 Keyboard POWER ON**

This item allows you to select wake-up the system by PS2 Keyboard when you save the computer power at S1-S5 mode.

The choice: Enabled, Disabled.

## **Wake Up by Modem & LAN**

When set to Enabled, any event occurring to the Modem ring / LAN will awaken a system which has been powered down.

The choice: Enabled, Disabled.

## **MODEM Use IRQ**

The determine the IRQ in which the MODEM can use.

The choice: 3, 4, 5, 7, 9, 10, 11, NA.

## **RTC Resume**

This option allows you to have the system turn on at a present time each day or on a certain day.

The choice: Disabled, Enabled.

## **IRQ Wakeup Events**

Allows users to set system to monitor IRQs 3-15 for activity to awaken system form a power management mode.

## **VGA**

When set to On (default), any event occurring at a VGA port will awaken a system which has been powered down.



**LPT & COM**

When set to On (default), any event occurring at a COM(serial)/LPT (printer) port will awaken a system which has been powered down.

**HDD & FDD**

When set to On (default), any event occurring at a hard or floppy drive port will awaken a system which has been powered down.

**PCI master**

When set to On (default), any event occurring to the DMA controller will awaken a system which has been powered down.

## 4-6 PnP/PCI Configuration Setup

This section describes configuring the PCI bus system. PCI, or **Personal Computer Interconnect**, is a system which allows I/O devices to operate at speeds nearing the speed the CPU itself uses when communicating with its own special components. This section covers some very technical items and it is strongly recommended that only experienced users should make any changes to the default settings.

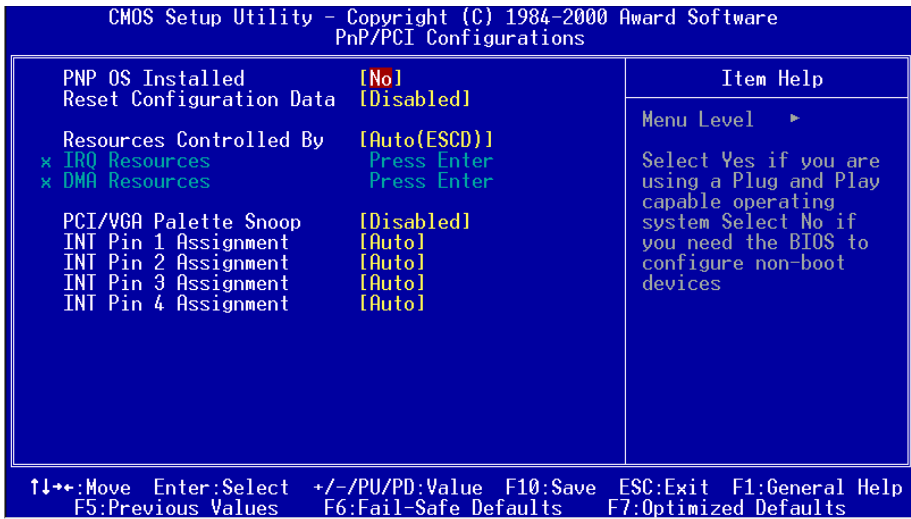

### PNP OS Installed

Do you have a PNP OS installed on your system. The default is No.

### Reset Configuration Data

Normally, you leave this field Disabled. Select Enabled to reset Extended System Configuration Data (ESCD) when you exit Setup if you have installed a new add-on and the system reconfiguration has caused such a serious conflict that the operating system can not boot.

The choice: Enabled, Disabled .

### Resource controlled by

The Award Plug and Play BIOS has the capacity to automatically configure all of the boot and Plug and Play compatible devices. However, this capability means

absolutely nothing unless you are using a Plug and Play operating system such as Windows95. If you set this field to “manual” choose specific resources by going into each of the sub menu that follows this field (a sub menu is preceded by a “Ø”).

The choice: Auto(ESCD), Manual.

**PCI/VGA Palette Snoop**

Leave this field at *Disabled*.

Choices are Enabled, Disabled.

**INT Pin1 to Pin4 Assignment**

These settings allow the user to specify what IRQ will be assigned to PCI devices in the chosen slot. Options available: Auto,3,4,5,7,9,10,11,12,14 & 15. The defaults are Auto.

## 4-7 PC Health Status

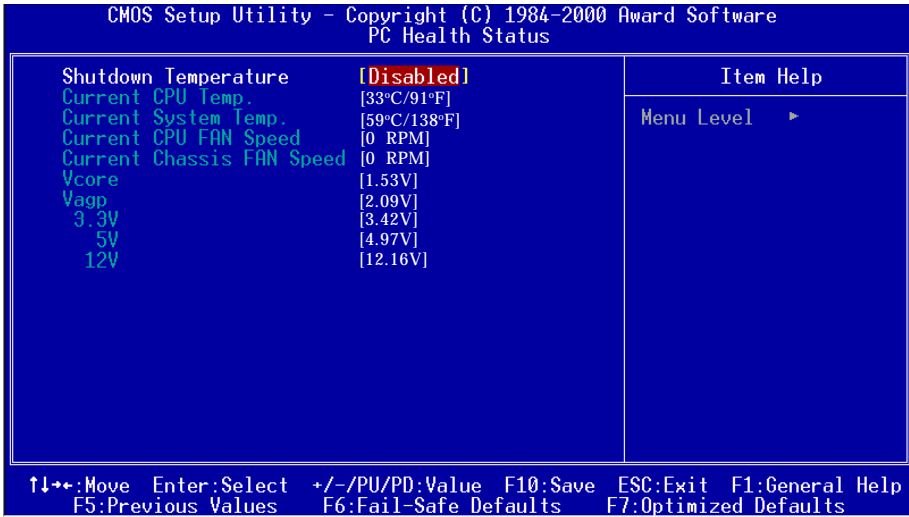

### Shutdown Temperature

This is the temperature that the computer will turn off the power to combat the effects of an overheating system. (requires ACPI to be enabled in Power Management BIOS and ACPI compliant operating system.) The default is Disabled.

Options available are 60°C/140°F to 100°C/212°F in increments of 5°C.

### Current CPU / System Temperature

This is the current temperature of the CPU/System.

### Current CPU Fan / Chassis Fan Speed

The current CPU fan speed in RPMs.

### Vcore

The voltage level of the Vcore.

### Vagp

The voltage level of Power supplied to AGP card.

1.52V: for 4X AGP card.

3.3V : for 2X AGP card.

**3.3V, 5V, 12V:** The voltage level of the switch power supply.

## 4-8 Frequency/Voltage Control

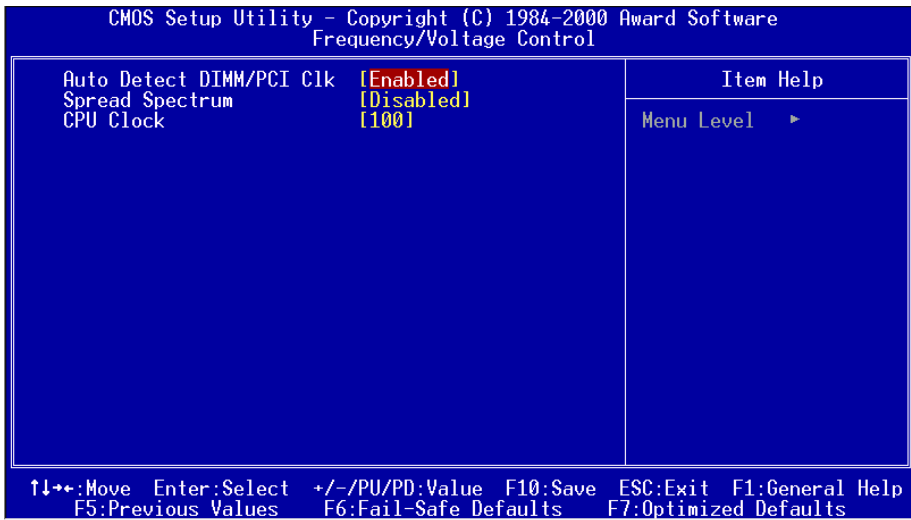

### Auto Detect DIMM/PCI Clk

This item allows you to enable/disable auto detect DIMM/PCI Clock.  
The choice: Enabled, Disabled.

### Spread Spectrum Modulate

This item allows you to enable/disable the spread spectrum modulate.  
The choice: Enabled, Disabled.

### CPU Clock

The mainboard is designed to set the CPU clock via BIOS. This item allows you to select the CPU Host clock speed by “Enter” key. The default speed depends on what CPU was installed.

**Note: Overclocking failure will cause system No display problem. At this moment, please press “Insert” key to back to the initial or default setting to boot up your system.**

## 4-9 Defaults Menu

---

Selecting “Defaults” from the main menu shows you two options which are described below

### **Load Fail-Safe Defaults**

When you press <Enter> on this item you get a confirmation dialog box with a message similar to:

Load Fail-Safe Defaults (Y/N) ? N

Pressing ‘Y’ loads the BIOS default values for the most stable, minimal-performance system operations.

### **Load Optimized Defaults**

When you press <Enter> on this item you get a confirmation dialog box with a message similar to:

Load Optimized Defaults (Y/N) ? N

Pressing ‘Y’ loads the default values that are factory settings for optimal performance system operations.

---

## 4-10 Supervisor/User Password Setting

---

You can set either supervisor or user password, or both of them. The differences between are:

**supervisor password** : can enter and change the options of the setup menus.

**user password** : just can only enter but do not have the right to change the options of the setup menus. When you select this function, the following message will appear at the center of the screen to assist you in creating a password.

### ENTER PASSWORD:

Type the password, up to eight characters in length, and press <Enter>. The password typed now will clear any previously entered password from CMOS memory. You will be asked to confirm the password. Type the password again and press <Enter>. You may also press <Esc> to abort the selection and not enter a password. To disable a password, just press <Enter> when you are prompted to enter the password. A message will confirm the password will be disabled. Once the password is disabled, the system will boot and you can enter Setup freely.

### PASSWORD DISABLED.

When a password has been enabled, you will be prompted to enter it every time you try to enter Setup. This prevents an unauthorized person from changing any part of your system configuration.

Additionally, when a password is enabled, you can also require the BIOS to request a password every time your system is rebooted. This would prevent unauthorized use of your computer.

You determine when the password is required within the BIOS Features Setup Menu and its Security option (see Section 3). If the Security option is set to "System", the password will be required both at boot and at entry to Setup. If set to "Setup", prompting only occurs when trying to enter Setup.

## 4-11 Exit Selecting

---

### **Save & Exit Setup**

Pressing <Enter> on this item asks for confirmation:

**Save to CMOS and EXIT (Y/N)? Y**

Pressing “Y” stores the selections made in the menus in CMOS – a special section of memory that stays on after you turn your system off. The next time you boot your computer, the BIOS configures your system according to the Setup selections stored in CMOS. After saving the values the system is restarted again.

### **Exit Without Saving**

Pressing <Enter> on this item asks for confirmation:

**Quit without saving (Y/N)? Y**

This allows you to exit Setup without storing in CMOS any change. The previous selections remain in effect. This exits the Setup utility and restarts your computer.



#### Easy Driver Installation



**Insert the bundled autorun driver in CD-disk.**

**Step 1 :** Click **AMD MINIPOINT DRIVER** to install MiniPort.

**Step 2 :** Click **VIA BUS MASTER PCI IDE DRIVER** to install Bus Master PCI IDE.

**Step 3 :** Click **686A/B AUDIO DRIVER** to install the Audio Sound Driver.

**Step 4 :** Click **USB Driver** to install USB.

**Step 5 :** Click **HPT370(A) DRIVER** to install HPT370(A).

**Step 6 :** Click **HPT370(A) RAID ADMINISTRATOR** to install HPT370(A) RAID Administrator.



Appendix A

**NOTE:**

The "**LOAD Optimized DEFAULTS**" function loads the system default data directly from ROM and initializes the associated hardware properly. This function will be necessary when you accept this mainboard, or the system CMOS data is corrupted.

CMOS Setup Utility - Copyright ( C ) 1984-1998

Standard CMOS Feature	Frequency/Voltage Control
Advanced BIOS Feature	Load Fail-Safe Defaults
Advanced Chipset Feature	Load Optimized Defaults
Integrated Peripherals	Set Supervisor Password
Power Management Setup	Load Optimized Defaults (Y/N)? Y
PnP/PCI Configuration	
PC Health Status	Exit Without Saving
Esc : Quit	↑ ↓ ← → : Select Item
F10 : Save & Exit Setup	
Time, Date, Hard Disk Type....	

**LOAD Optimized DEFAULTS**



B-1 GHOST 5.1/6.03 Quick User's Guide

Installation is very easy. You only need to copy the **Ghost5** folder or **Ghost.exe** to your hard disk.

The current market version is for single **Client**, so the LPT and NetBios portions will not be explained further.

**Description of Menus**

**Ghost** clones and backs up **Disk** and **Partition**.

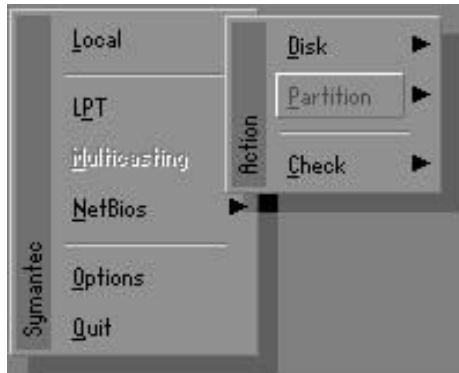

In which **Disk** indicates hard disk options  
**Partition** indicates partition options  
**Check** indicates check options

**Disk**

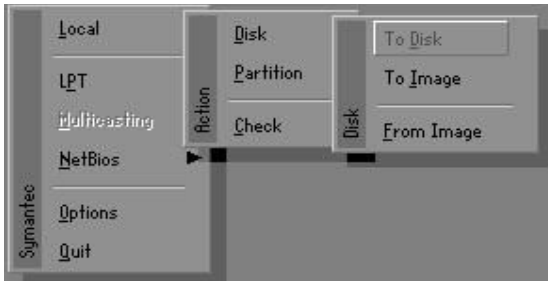

# Appendix

---

## There are 3 hard disk functions:

1. Disk To Disk (disk cloning)
2. Disk To Image (disk backup)
3. Disk From Image (restore backup)

## Important!

1. To use this function, the system must have at least 2 disks. Press the **Tab** key to move the cursor.
2. When restoring to a destination disk, all data in that disk will be completely destroyed.

## Disk To Disk (Disk Cloning)

1. Select the location of the **Source** drive.
2. Select the location of the **Destination** drive.

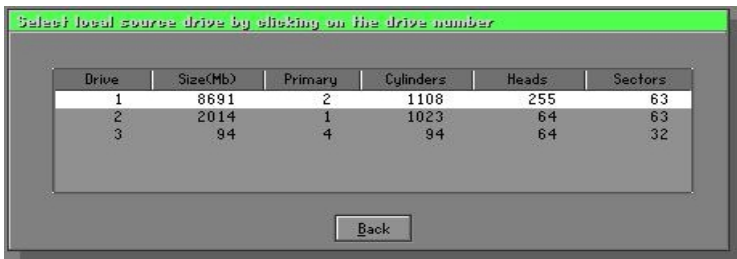

3. When cloning a disk or restoring the backup, set the required partition size as shown in the following figure.

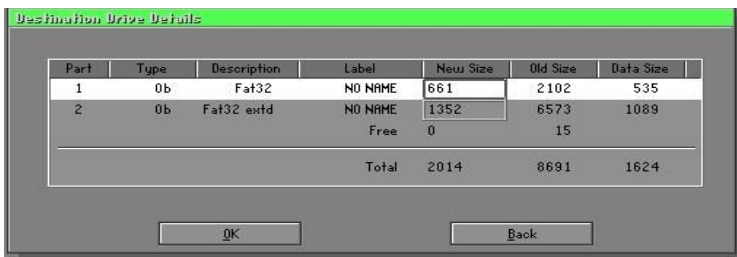

- Click OK to display the following confirmation screen. Select **Yes** to start.

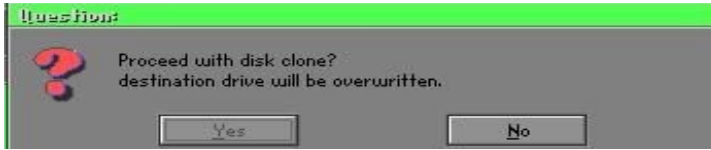

## Disk To Image (Disk Backup)

- Select the location of the Source drive.

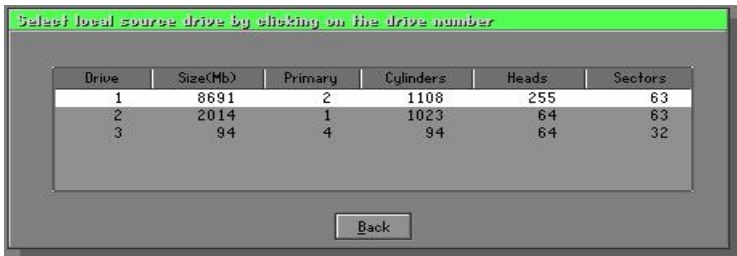

- Select the location for storing the backup file.

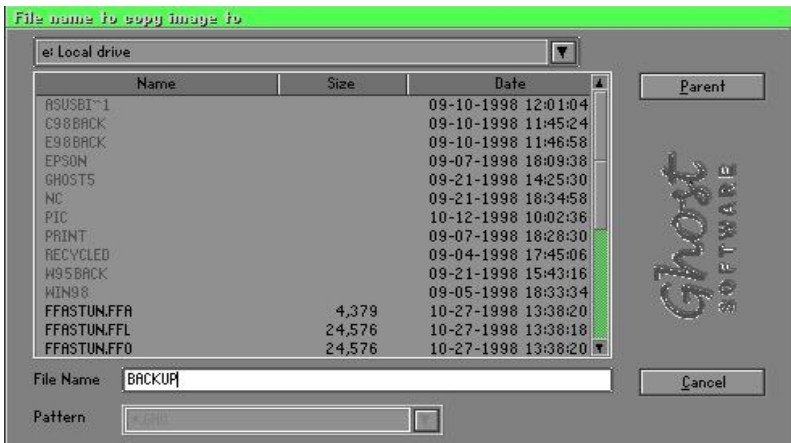

## Appendix

---

- Click **OK** to display the following confirmation screen. Select **Yes** to start.



### Disk From Image (Restore Backup)

- Select the Restore file.

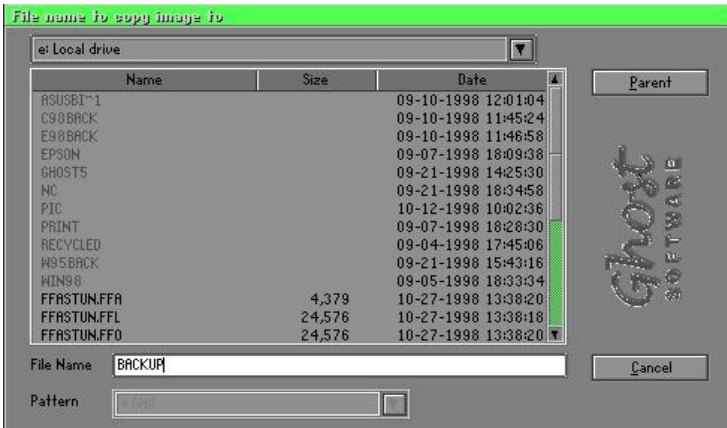

- Select the **Destination drive** of the disk to be restored.

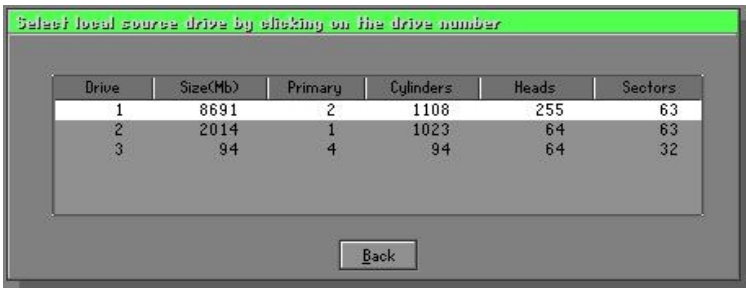



- When restoring disk backup, set the required partition size as shown in the following figure.

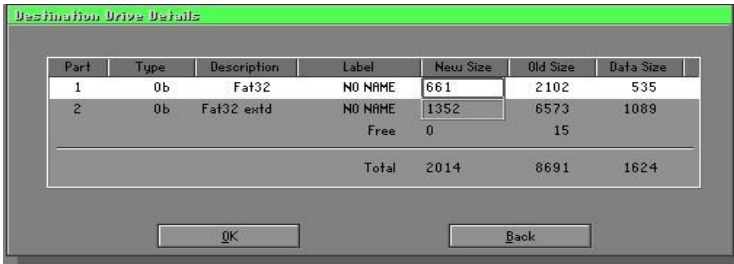

- Click **OK** to display the following confirmation screen. Select **Yes** to start.

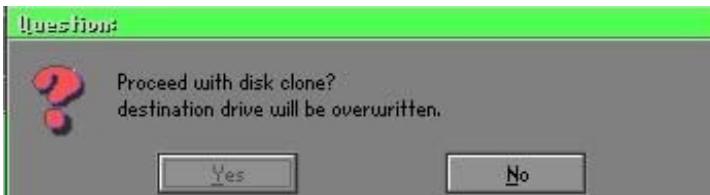

## Partition

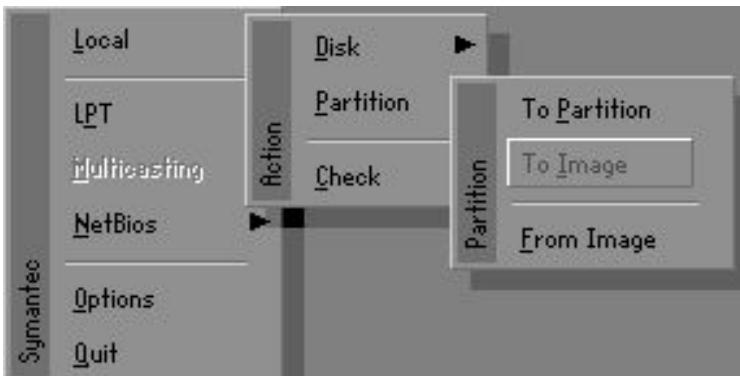

# Appendix

---

There are 3 partition functions:

1. **Partition To Partition** (partition cloning)
2. **Partition To Image** (partition backup)
3. **Partition From Image** (restore partition)

## Partition To Partition (Partition Cloning)

The basic unit for partition cloning is a partition. Refer to disk cloning for the operation method.

## Partition To Image (Partition Backup)

1. Select the disk to be backed up.

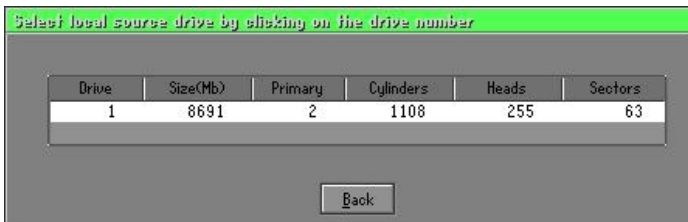

2. Select the first partition to be backed up. This is usually where the operating system and programs are stored.



3. Select the path and file name for storing the backup file.

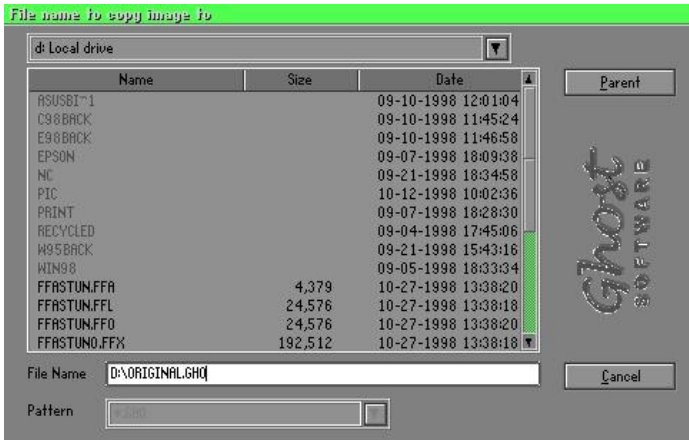

4. Is the file compressed? There are 3 options:

(1) No: do not compress data during backup

(2) Fast: Small volume compression

(3) High: high ratio compression. File can be compressed to its minimum, but this requires longer execution time.

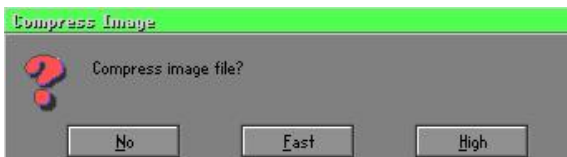

5. During confirmation, select Yes to start performing backup.

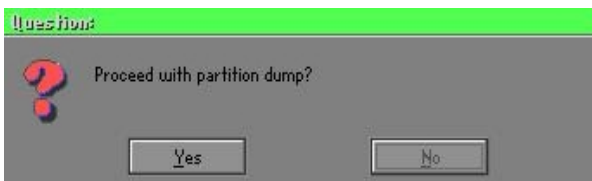

# Appendix

---

## Partition From Image (Restore Partition)

1. Select the backup file to be restored.

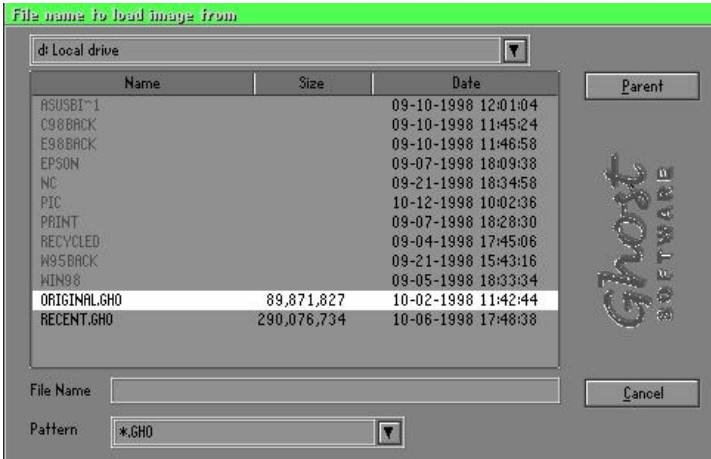

2. Select the source partition.

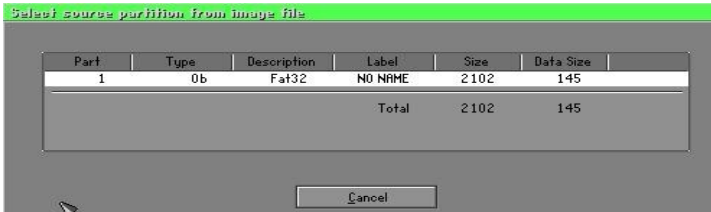

3. Select the disk to be restored.



4. Select the partition to be restored.

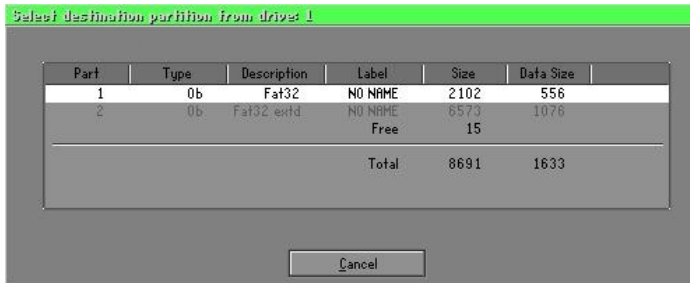

5. Select Yes to start restoring.

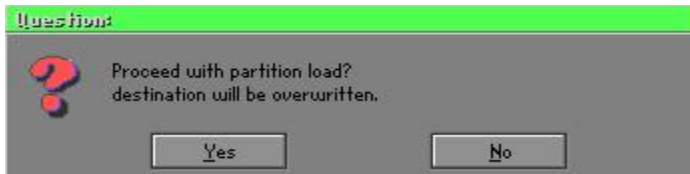

## Check

This function checks the hard disk or backup file for backup or restoration error due to FAT or track error.

### How to Reinstall Windows in 2 Minutes

**This chapter teaches you how to set your computer properly and, if necessary, reinstall Windows in 2 minutes. Ghost can use different methods to complete this task. The following two sections explain the creation of the emergency Recover Floppy and Recover CD:**

#### Emergency Recover Floppy

Divide a hard disk into two partitions. The first partition is for storing the operating system and application programs. The second partition is for backing up the operating system and data. The size of the partition can be set according to the backup requirements. For example, the **Windows** operating system needs 200MB of hard disk space, while the complete **Office** installation requires 360MB. The remaining space can be used to store other data.

After installing **Windows**, use **Ghost** to create a backup of the source system and store the file (Image file) in drive D. The file is named as **Original.gho**. Then, create a recover floppy disk containing:

- ◆ Bootable files (Command.com, Io.sys, and MSDOS.SYS )
- ◆ Config.sys (configuration setup file)
- ◆ Autoexec.bat (auto-execution batch file)
- ◆ Ghost.exe (Ghost execution file)

There are two ways to set the content of the recover floppy for restoration:

- (1) To load **Windows** automatically after booting, set the **Autoexec.bat** command as:

```
Ghost.exe clone, mode=pload, src=d:\original.gho:2,dst=1:1 -fx -sure -rb
```

Description: Runs the restore function automatically using the Image File. After execution, it exits Ghost and boots the system automatically.

Refer to the [Introducing Ghosts Functions].

- (2) After booting, the screen displays the Menu. Select Backup or Restore: Since the user may install other applications in the future, he/she may design **Autoexec.bat** as a Menu to back up or restore the user-defined Image file as follows:

### **Backup**

Back up Windows and application programs as a file (Recent.gho). Command is:

```
Ghost -clone,mode=pdump,src=1:1,dst=d:\Recent.gho -fx -sure -rb
```

### **Restore**

Restore types include [**General Windows**] and [**Windows and Application Programs**]. If you select [**General Windows**], the system is restored to the general **Windows** operation condition. The command is:

```
Ghost.exe -clone,mode=pload,src=d:\Original.gho,dst=1:1 -fx -sure -rb
```

If you select [**Windows and Application Programs**], the latest backup file (Recent.gho) is restored, skipping the installation and setup of application programs.

For description of relevant parameters, refer to [**Introducing Ghosts Functions**].

For more information about menu design, refer to Config.sys and Autoexec.bat under /Menu in the CD. You can also create a backup CD containing Ghost.exe and these two files.

### Recover CD

In recent years, well-known computer manufacturers (such as IBM, Acer, Compaq, etc.) bundle Recover CDs with their computers to reduce the cost resulting from servicing, while at the same time increasing their market competitiveness.

The following is a simple guide to how to create a recover CD:

1. For extremely easy creation of the recover floppy disk, use the copy program for example “Easy CD Creator “ (Note 2). First, create a recover floppy disk containing:

Bootable files (Command.com and Io.sys and MSDOS.SYS)

Config.sys (Configuration setup file)

Autoexec.bat (Auto-execution batch file)

Mscdex.exe (CD-Rom execution file)

Ghost.exe (Ghost execution file)

Oakcdrom.sys (ATAPI CD-ROM compatible driver)

The content of Config.sys is:

```
DEVICE=Oakcdrom.sys /d:idecd001
```

The content of Autoexec.bat includes:

```
MSCDEX.EXE /D:IDECD001 /L:Z
```

```
Ghost.exe clone,mode=load,src=z:\original.gho,dst=1 -sure -rb
```

2. Write the backup image file (original.gho) of the entire hard disk or partition into the recover CD. Use the Recover CD to boot up the system and restore the backup files automatically.

For description of relevant parameters, refer to **[Introducing Ghosts Functions]**.

Note: For more details regarding the creation program and method for creating the recover CD, please refer to the legal software and relevant operation manual.



## Ghost Command Line Switches Reference

Ghost may be run in interactive or in batch mode. Batch mode is useful for automating installations for backups using Ghost. Most of the Ghost switches are used to assist with batch mode operation. To list switches from Ghost, type `ghost.exe -h`.

### **-clone**

The full syntax for this switch is:

```
clone,MODE={ copy|load|dump|pcopy|pload|pdump },SRC=
{ drive|file|drive:partition|,DST={ drive|file|drive:partition } ,SIZE{ F|L|n=
{ nnnnM|nnP|F|V }
```

Clone using arguments. This is the most useful of the batch switches and has a series of arguments that define:

- a) **MODE** This defines the type of clone command to be used:
- |              |                             |
|--------------|-----------------------------|
| <b>COPY</b>  | disk to disk copy           |
| <b>LOAD</b>  | file to disk load           |
| <b>DUMP</b>  | disk to file dump           |
| <b>PCOPY</b> | partition to partition copy |
| <b>PLOAD</b> | file to partition load      |
| <b>PDUMP</b> | partition to file dump      |
- b) **SRC** This defines the source location for the operation:
- | <b>Mode</b>   | <b>Meaning:</b>   |
|---------------|---|
| <b>COPY/</b>  |   |
| <b>DUMP</b>   | Source drive (e.g, 1 for drive one)   |
| <b>LOAD</b>   | Disk image filename or device (e.g, g:\Images\system2.img)  |
| <b>PCOPY/</b> |   |
| <b>PDUMP</b>  | Source partition e.g, 1:2 indicates the second partition on drive one.  |
| <b>PLOAD</b>  | Partition image filename or device and partition number. Example: g:\images\disk1.img:2 indicates the second partition in the Image file. |

# Appendix

---

- c) **DST**            This defines the destination location for the operation:
- | <b>Mode</b>   | <b>Meaning</b>  |
|---------------|---|
| <b>COPY/</b>  |   |
| <b>LOAD</b>   | Destination drive (e.g, 2 for drive two)                                      |
| <b>DUMP</b>   | Disk image filename or device,(e.g, g:\images\system2.img)                    |
| <b>PCOPY/</b> |   |
| <b>PLOAD</b>  | Destination partition,(e.g, 2:2 indicates the second partition on drive two). |
| <b>PDUMP</b>  | Partition image filename (e.g, g:\images\part1.img).                          |
- c) **SIZEy**            Used to set the size of the destination partitions for either a disk load or disk copy operation.

## Available y Options:

- F**            Resizes the first partition to maximum size allowed based on file system t type.
- L**            Resizes the last partition to maximum size allowed based on file system type.
- n=xxxxM**    - indicates that the n?h destination partition is to have a size of xxxx Mb. (e.g, **SZE2=800M** indicates partition two is to have 800 mb.)
- n=mmP**    - indicates that the n?h destination partition is to have a size of mm percent of the target disk.
- n=F**            - indicates that the n?h destination partition is to remain fixed in size.
- n=V**            - Indicates that the partition will be resized according to the following rules:
  - Rule 1** - If the destination disk is larger than the original source disk, then the partition(s) will be expanded to have the maximum amount of space subject to the free space available and the partition type (e.g, FAT16 partitions will have a maximum size of 2048Mb.)
  - Rule 2** - If the destination disk is smaller than the original source disk, (but still large enough to accommodate the data from the source disk), the free space left over after the

data space has been satisfied will be distributed between the destination partitions in proportion to the data usage in the source partitions. Some examples follow that will help illustrate:

- fx flag Exit. Normally when Ghost has finished copying a new system to a disk, it prompts the user to reboot with a press Ctrl-Alt-Del to reboot window. However, if Ghost is being run as part of a batch file it is sometimes useful to have it just exist back to the DOS prompt after completion so that further batch commands may be processed. -fx enables this. See -rb for another option on completing a clone.
- ia Image All. The Image All switch forces Ghost to do a sector by sector copy of all partitions. When copying a partition from a disk to an image file or to another disk, Ghost examines the source partition and decides whether to copy just the files and directory structure, or to do an image (sector by sector) copy. If it understands the internal format of the partition it defaults to copying the files and directory structure. Generally this is the best option, but occasionally if a disk has been set up with special hidden security files that are in specific positions on the partition, the only way to reproduce them accurately on the target partition is via an image or sector-by-sector copy.
- span enables spanning across volumes.
- split=x splits image file into 'x' Mb? Mb spans. Use this to create a 'forced' size volume set. For example, if you would like to force smaller image files from a 1024 Megabyte drive, you could specify 200 megabyte segments. For example, ghost.exe -split=200 will divide the image into 200 Megabyte segments.
- sure use the -sure switch in conjunction with -clone to avoid being prompted with the final 'Proceed with disk clone destination drive will be overwritten?' question. This command is useful in batch mode.

## Appendix

---

### Example 1:

To copy drive one to drive two on a PC, without final prompt if OK to proceed.

```
ghost.exe -clone,mode=copy,src=1,dst=2 -sure
```

### Example 2:

To connect via NetBIOS to another PC running Ghost in slave mode, and dump a disk image of local drive two to the remote file c:\drive2.gho

```
ghost.exe -clone,mode=dump,src=2,dst=C:\drive2.gho -nbm
```

Note: The slave Ghost can be started with ghost -nbs

### Example 3:

To copy drive one, second partition on a PC to drive two, first partition the same PC, without final prompt

```
ghost.exe -clone,mode=pcopy,src=1:2,dst=2:1 -sure
```

### Example 4:

To dump the second partition of drive one to an image file on a mapped drive g:

```
ghost.exe -clone,mode=pdump,src=1:2,dst=g:\part2.gho
```

### Example 5:

To load partition 2 from a two-partition image file on a mapped drive g: onto the second partition of the local disk

```
ghost -clone,mode=pload,src=g:\part2.gho:2,dst=1:2
```

### Example 6:

To load drive 2 from an image file and resize the destination partitions into a 20:40 allocation

```
ghost.exe -clone,mode=load,src=g:\2prtdisk.gho,dst=2,size1=60P,  
size2=40P
```

---

**C-1 POST CODES**

---

<b>POST (hex)</b>	<b>DESCRIPTION</b>
CfH	Test CMOS R/W functionality.
C0h	Early chipset initialization: <ul style="list-style-type: none"><li>- Disable shadow RAM</li><li>- Disable L2 cache (socket 7 or below)</li><li>- Program basic chipset registers</li></ul>
C1h	Detect memory <ul style="list-style-type: none"><li>- Auto-detection of DRAM size, type and ECC.</li><li>- Auto-detection of L2 cache (socket 7 or below)</li></ul>
C3h	Expand compressed BIOS code to DRAM
C5h	Call chipset hook to copy BIOS back to E000 & F000 shadow RAM.
0h1	Expand the Xgroup codes locating in physical address 1000:0
02h	Reserved
03h	Initial Superio_Early_Init switch.
04h	Reserved
05h	<ol style="list-style-type: none"><li>1. Blank out screen</li><li>2. Clear CMOS error flag</li></ol>
06h	Reserved
07h	<ol style="list-style-type: none"><li>1. Clear 8042 interface</li><li>2. Initialize 8042 self-test</li></ol>
08h	<ol style="list-style-type: none"><li>1. Test special keyboard controller for Winbond 977 series Super I/O chips.</li><li>2. Enable keyboard interface.</li></ol>
09h	Reserved
0Ah	<ol style="list-style-type: none"><li>1. Disable PS/2 mouse interface (optional).</li><li>2. Auto detect ports for keyboard &amp; mouse followed by a port &amp; interface swap (optional).</li><li>3. Reset keyboard for Winbond 977 series Super I/O chips.</li></ol>
0B-0Dh	Reserved

---

## Appendix

---

0Eh	Test F000h segment shadow to see whether it is R/W-able or not. If test fails, keep beeping the speaker.
0Fh	Reserved
10h	Auto detect flash type to load appropriate flash R/W codes into the run time area in F000 for ESCD & DMI support.
11h	Reserved
12h	Use walking 1's algorithm to check out interface in CMOS circuitry. Also set real-time clock power status, and then check for override.
13h	Reserved
14h	Program chipset default values into chipset. Chipset default values are MODBINable by OEM customers.
15h	Reserved
16h	Initial Early_Init_Onboard_Generator switch.
17h	Reserved
18h	Detect CPU information including brand, SMI type (Cyrix or Intel) and CPU level (586 or 686).
19-1Ah	Reserved
1Bh	Initial interrupts vector table. If no special specified, all H/W interrupts are directed to SPURIOUS_INT_HDLR & S/W interrupts to SPURIOUS_soft_HDLR.
1Ch	Reserved
1Dh	Initial EARLY_PM_INIT switch.
1Eh	Reserved
1Fh	Load keyboard matrix (notebook platform)
20h	Reserved
21h	HPM initialization (notebook platform)
22h	Reserved
23h	<ol style="list-style-type: none"><li>1. Check validity of RTC value: e.g. a value of 5Ah is an invalid value for RTC minute.</li><li>2. Load CMOS settings into BIOS stack. If CMOS checksum fails, use default value instead.</li><li>3. Prepare BIOS resource map for PCI &amp; PnP use. If ESCD is valid, take into consideration of the ESCD's legacy information.</li></ol>

	4. Onboard clock generator initialization. Disable respective clock resource to empty PCI & DIMM slots.
	5. Early PCI initialization: -Enumerate PCI bus number -Assign memory & I/O resource -Search for a valid VGA device & VGA BIOS, and put it into C000:0.
24-26h	Reserved
27h	Initialize INT 09 buffer
28h	Reserved
29h	1. Program CPU internal MTRR (P6 & PII) for 0-640K memory address. 2. Initialize the APIC for Pentium class CPU. 3. Program early chipset according to CMOS setup. Example: onboard IDE controller. 4. Measure CPU speed. 5. Invoke video BIOS.
2A-2Ch	Reserved
2Dh	1. Initialize multi-language 2. Put information on screen display, including Award title, CPU type, CPU speed ....
2E-32h	Reserved
33h	Reset keyboard except Winbond 977 series Super I/O chips.
34-3Bh	Reserved
3Ch	Test 8254
3Dh	Reserved
3Eh	Test 8259 interrupt mask bits for channel 1.
3Fh	Reserved
40h	Test 8259 interrupt mask bits for channel 2.
41h	Reserved
42h	Reserved
43h	Test 8259 functionality.
44h	Reserved
45-46h	Reserved
47h	Initialize EISA slot

---

## Appendix

---

48h	Reserved
49h	<ol style="list-style-type: none"><li>1. Calculate total memory by testing the last double word of each 64K page.</li><li>2. Program writes allocation for AMD K5 CPU.</li></ol>
4A-4Dh	Reserved
4Eh	<ol style="list-style-type: none"><li>1. Program MTRR of M1 CPU</li><li>2. Initialize L2 cache for P6 class CPU &amp; program CPU with proper cacheable range.</li><li>3. Initialize the APIC for P6 class CPU.</li><li>4. On MP platform, adjust the cacheable range to smaller one in case the cacheable ranges between each CPU are not identical.</li></ol>
4Fh	Reserved
50h	Initialize USB
51h	Reserved
52h	Test all memory (clear all extended memory to 0)
53-54h	Reserved
55h	Display number of processors (multi-processor platform)
56h	Reserved
57h	<ol style="list-style-type: none"><li>1. Display PnP logo</li><li>2. Early ISA PnP initialization -Assign CSN to every ISA PnP device.</li></ol>
58h	Reserved
59h	Initialize the combined Trend Anti-Virus code.
5Ah	Reserved
5Bh	(Optional Feature) Show message for entering AWDFLASH. EXE from FDD (optional)
5Ch	Reserved
5Dh	<ol style="list-style-type: none"><li>1. Initialize Init_Onboard_Super_IO switch.</li><li>2. Initialize Init_Onboard_AUDIO switch.</li></ol>
5E-5Fh	Reserved
60h	Okay to enter Setup utility; i.e. not until this POST stage can users enter the CMOS setup utility.
61-64h	Reserved
65h	Initialize PS/2 Mouse



66h	Reserved
67h	Prepare memory size information for function call: INT 15h ax=E820h
68h	Reserved
69h	Turn on L2 cache
6Ah	Reserved
6Bh	Program chipset registers according to items described in Setup & Auto-configuration table.
6Ch	Reserved
6Dh	<ol style="list-style-type: none"><li>1. Assign resources to all ISA PnP devices.</li><li>2. Auto assign ports to onboard COM ports if the corresponding item in Setup is set to "AUTO".</li></ol>
6Eh	Reserved
6Fh	<ol style="list-style-type: none"><li>1. Initialize floppy controller</li><li>2. Set up floppy related fields in 40:hardware.</li></ol>
70-72h	Reserved
73h	(Optional Feature) Enter AWDFLASH.EXE if : -AWDFLASH is found in floppy drive. -ALT+F2 is pressed
74h	Reserved
75h	Detect & install all IDE devices: HDD, LS120, ZIP, CDROM.....
76h	Reserved
77h	Detect serial ports & parallel ports.
78h	Reserved
79h	Reserved
7Ah	Detect & install co-processor
7B-7Eh	Reserved
7Fh	<ol style="list-style-type: none"><li>1. Switch back to text mode if full screen logo is supported. -If errors occur, report errors &amp; wait for keys -If no errors occur or F1 key is pressed to continue:<ul style="list-style-type: none"><li>◆ Clear EPA or customization logo.</li></ul></li></ol>
80h	Reserved
81h	Reserved
82h	<ol style="list-style-type: none"><li>1. Call chipset power management hook.</li><li>2. Recover the text fond used by EPA logo (not for full</li></ol>

## Appendix

---

	screen logo)
	3. If password is set, ask for password.
83h	Save all data in stack back to CMOS
84h	Initialize ISA PnP boot devices
85h	<ol style="list-style-type: none"><li>1. USB final Initialization</li><li>2. NET PC: Build SYSID structure</li><li>3. Switch screen back to text mode</li><li>4. Set up ACPI table at top of memory.</li><li>5. Invoke ISA adapter ROMs</li><li>6. Assign IRQs to PCI devices</li><li>7. Initialize APM</li><li>8. Clear noise of IRQs.</li></ol>
86-92h	Reserved
93h	Read HDD boot sector information for Trend Anti-Virus code
94h	<ol style="list-style-type: none"><li>1. Enable L2 cache</li><li>2. Program boot up speed</li><li>3. Chipset final initialization.</li><li>4. Power management final initialization</li><li>5. Clear screen &amp; display summary table</li><li>6. Program K6 write allocation</li><li>7. Program P6 class write combining</li></ol>
95h	<ol style="list-style-type: none"><li>1. Program daylight saving</li><li>2. Update keyboard LED &amp; typematic rate</li></ol>
96h	<ol style="list-style-type: none"><li>1. Build MP table</li><li>2. Build &amp; update ESCD</li><li>3. Set CMOS century to 20h or 19h</li><li>4. Load CMOS time into DOS timer tick</li><li>5. Build MSIRQ routing table.</li></ol>
FFh	Boot attempt (INT 19h)

## D-1 EEPROM BIOS Remover

---

Do not remove the BIOS chip, unless instructed by a technician and only with a PLCC IC extractor tool.

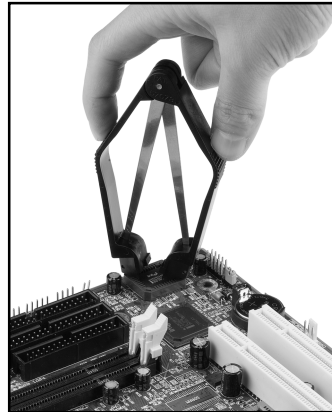
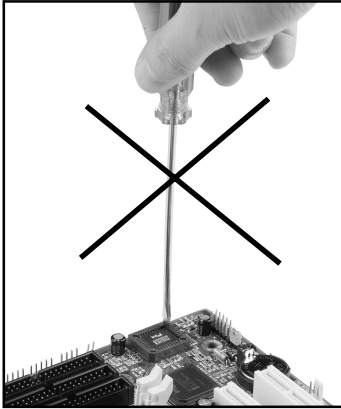

The BIOS socket may be damaged if using an improper method to replace the BIOS chip.

