

82430VX PCIset

P55-TV

ISA PCI MotherBoard

with Onboard PCI IDE and Super Multi-I/O.

TRADEMARK

All products and company names are trademarks or registered trademarks of their respective holders.

The specification is subject to change without notice.

Contents

	page
Chapter 1 - Introduction.....	1-1
P55-TV Board Layout.....	1-2
Chapter 2 - Hardware Design.....	2-1
2-1 Motherboard Layout	2-1
2-2 Connectors and Jumpers	2-2
2-3 System Memory configuration	2-4
2-4 Cache Memory configuration	2-6
2-5 Integrated PCI Bridge	2-8
Chapter 3 - Award BIOS SETUP	3-1
3-1 Standard CMOS Setup	3-2
3-3 BIOS Features Setup	3-2
3-3 Chipset Features Setup	3-6
3-4 Power Management Setup	3-8
3-5 PNP/PCI Configuration	3-10
3-6 Integrated Peripherals.....	3-12
3-7 Load Setup Defaults	3-14
3-8 Change Supervisor or User password	3-15
3-9 IDE HDD Auto Detection	3-16
3-10 HDD Low Level Format.....	3-18
3-11 Save & Exit Setup	3-18
3-11 Exit Without Saving	3-18
Chapter 4 - Onboard Technical Information.....	4-1
4-1 I/O & Memory Map	4-1
4-2 Time & DMA Channels Map	4-2
4-3 Interrupt Map	4-2
4-4 RTC & CMOS RAM Map	4-3
Appendix A: Post Codes	4-4
Appendix B: I/O Connector	4-8
Appendix C: Memory Configuration Table.....	4-11

NOTE :

The "**LOAD SETUP DEFAULTS**" function loads the system default data directly from ROM and initialize associated hardware properly. This function will be necessary when you accept this motherboard, or the system CMOS data is corrupted.

ROM PCI/ISA BIOS CMOS SETUP UTILITY AWARD SOFTWARE, INC.	
STANDARD CMOS SETUP	SUPERVISOR PASSWORD
BIOS FEATURES SETUP	USER PASSWORD
CHIPSET FEATURES SETUP	IDE HDD AUTO DETECTION
POWER MANAGEMENT SETUP	HDD LOW LEVEL FORMAT
PNP/PCI CONFIGURATION	LOAD SETUP DEFAULTS
INTEGRATED PERIPHERALS	LOAD SETUP Default (Y/N)? Y
LOAD SETUP DEFAULTS	LOAD SETUP SAVING
ESC: QUIT	↑↓→← :SELECT ITEM
F10:Save & Exit Setup	(Shift)F2 :Change Color
Load Setup Defaults Except Standard COMS SETUP	

LOAD SETUP DEFAULT

Chapter 1

Introduction

The **P55-TV** motherboard is a high performance system hardware based on Intel Pentium® processor and is equipped with four PCI slots, four standard ISA slots, Super Multi-I/O controller and dual ports PCI-IDE connectors for the future expansion. The hardware dimension is 220mm x 280mm with four layer design technology.

Specification

- Intel 82430VX PCIset chipset.
- Intel Pentium® Processor operating at **75 ~ 200 MHz** and **P55C** with **321 ZIF socket 7** provides scalability to accept faster Processors in the future.
- Supports up to 128 MegaBytes DRAM(minimum of 8 MB) on board(72 Pins SIMM x 4, 168 Pins DIMM x 1), and BIOS auto FP DRAM, EDO DRAM and SDRAM configuration.(Refer to Chapter 2-3 System Memory Configuration)
- Supports Onboard Burst/Pipelined burst synchronous (the **COAST 2.1** solution) L2 **Write Back** Cache. The cache memory combination could be 256KB/512KB (32KB*32 or 64KB*32 SRAM respectively).
- Support four 16 bits ISA slots, four 32 bits PCI slots, and provides two independent high performance PCI IDE interface capable of supporting **PIO Mode 3 and Mode 4** devices. The **P55-TV** supports four PCI Bus Masters and a jumperless PCI INT# control scheme which reduces configuration confusion when plug in PCI I/O controller card(s).
- Supports **AT API** (e.g. **CD-ROM**) devices on both IDE interface.
- Supports 1 floppy port, 1 parallel port (EPP,ECP port), and 2 serial port (16550 Fast UART compatible).
- Supports a **PS/2** style mouse and standard AT style keyboard connectors.
- Supports Award Plug & Play BIOS . The BIOS is stored in Flash EPROM form. It provides better upgradeability for the system.
- Supports CPU Hardware sleep and SMM (System Management Mode).
- **P55-TV** utilizes Lithium battery which provides environmental protection and longer life time.

P55-TV Layout

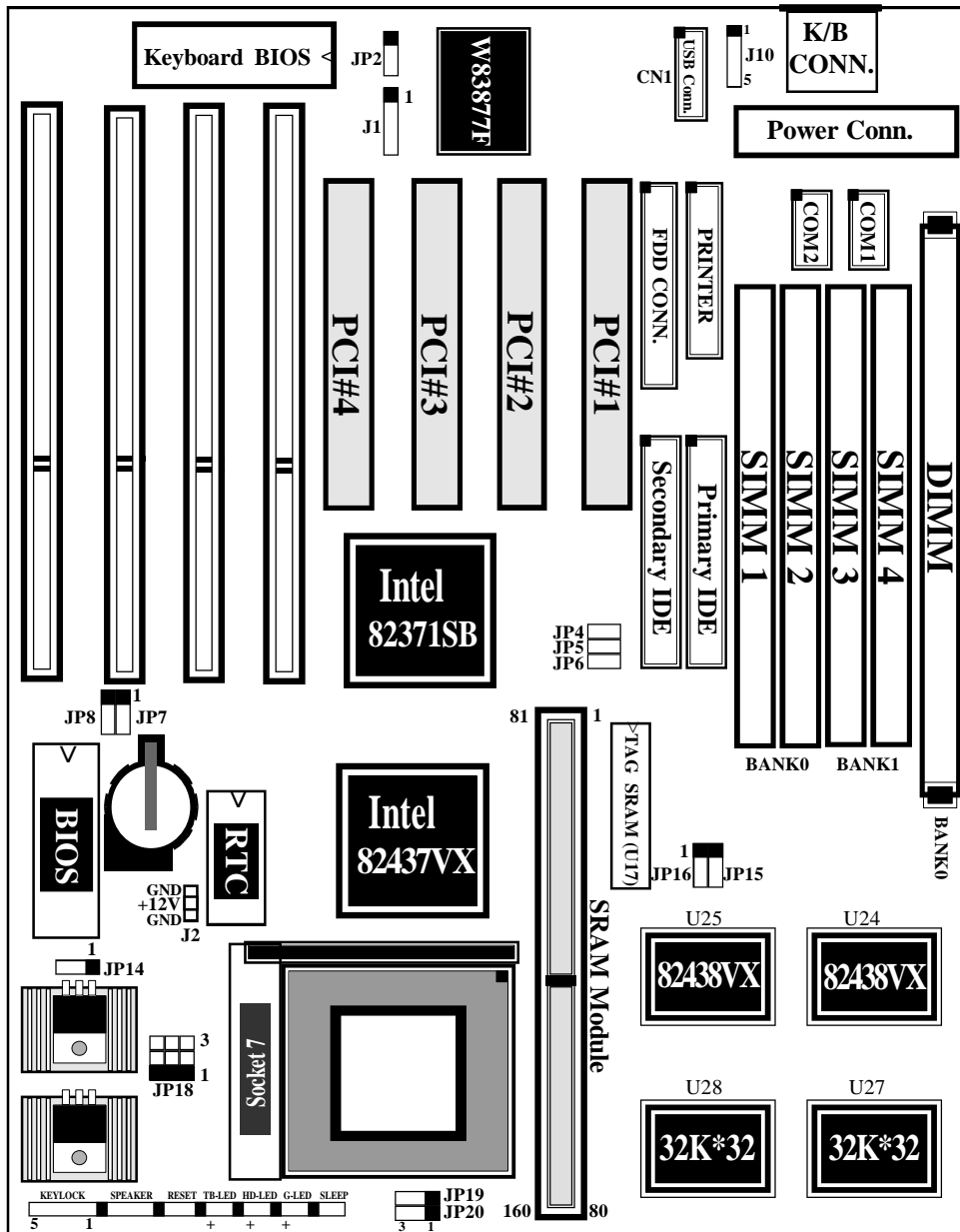

Figure 1-1

Chapter 2

Hardware design

2-1 Motherboard Layout

The P55-TV is designed with Intel 82430VX PCIset chipset which is developed by INTEL Corporation to fully support Pentium Processor PCI/ISA system. The Intel 82430VX PCIset chipset provides increased integration and improved performance designs. The chipset provides an integrated IDE controller with two high performance IDE interfaces for up to four IDE devices (hard devices, CD-ROM device, etc). The Winbond W83877F Super I/O controller provides the standard PC I/O function: floppy interface, two 16 Byte FIFO serial ports and EPP/ECP capable parallel port. The **P55-TV** layout is shown in previous page (left page) for user's reference. **Care must be taken** when inserting memory modules, inserting CPU or even plugging PCI card into associated slots to avoid damaging any circuits or sockets on board. A cooling fan is strongly recommended when installing P54C/P54CTB/P55C/K5/6x86 processor due to possible overheat.

The P55-TV supports minimum of 8MB of System Memory and maximum of 128MB while L2 Cache can be 256KB/512KB synchronous SRAM Onboard with the **COAST 2.1 "Cache-On-A-STick"** solution to increase system performance.(refer to **Page 2-5 Cache Memory Configuration** for the details.)

The P55-TV supports standard Fast Page, EDO (Extended Data Out or Hyper Page Mode) or synchronous DRAM. **The P55-TV** provides four 72-pins SIMM and one 168-pins DIMM sites for memory expansion. The socket support 1M x 32(4MB), 2M x 32(8MB), 4M x 32(16MB), and 8M x 32(32MB) single-sided or double-sided memory modules. The memory timing requires 70 nS Fast page devices or 60 nS EDO DRAM. Memory parity generation and checking is not supported. (DRAM Modules may be parity[x 36] or non-parity[x 32].

The P55-TV supports **Onboard two PCI IDE** connectors, and detects IDE harddisk type by BIOS utility automatic.

The P55-TV supports Award Plug & Play BIOS for the ISA and PCI cards. The BIOS can be located in Flash EPROM. The advantage of having Flash EPROM is much easier to replace BIOS code if necessary.

2-2 Connectors and Jumpers

This section describes all of the connectors and jumpers equipped in the motherboard. Please refer to **Figure 1-1** for actual location of each connector and jumper.



KeyLock - Keyboard lock switch & Power LED connector.

- 1.Power LED(+)
- 2.N/C
- 3.GND
- 4.Keylock
- 5.GND

Speaker - connect to the system's speaker for beeping.

7. Speaker
8. N/C
9. GND
10. GND

Reset - Close to restart system.

Turbo LED indicator - LED ON when higher speed is selected.

Power Saving LED indicator - LED ON when system is in any Saving mode.

Harddisk LED indicator - LED ON when Onboard PCI IDE Harddisks activites.

Sleep/Resume switch : Close to enter sleep mode.

A keystroke or mouse movement (mouse driver exists). The system will instantly "wake up".

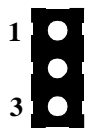

J2 The Power Supply (+12V) of the CPU Cooling FAN:

- 1.GND
- 2.+12V
- 3.GND

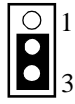
JP2  **Keyboard Clock Select :**
 1-2 : The Clock rate equal to the system ISA CLOCK.
 2-3 : The Clock rate equal to 12MHz.

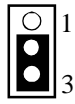
JP7  **BIOS Operation Mode :**
 1-2 : Normal Operating.
 2-3 : Bootblock Flash Mode.

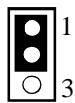
JP8  **EPROM BIOS Select :**
 1-2 : 5V Flash EPROM.(SST, Winbond).
 2-3 : 12V Flash EPROM (Intel).

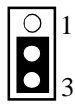
JP14  **CPU Vcore voltage select :**
 1-2 : 2.5V
 2-3 : 2.8V (Default)
 Open : 2.9V

Note : JP14 is reserved for Pentium MMX, Cyrix 6x86L and AMD K6 only. For other CPU it must be ignored.

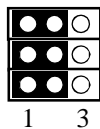
JP18  **CPU Install :**
 1-2 : Intel Pentium, Cyrix 6x86 and AMD K5.
 2-3 : Intel Pentium MMX, Cyrix 6x86L and AMD K6.

J1  **IrDA/ASK IR CONNECTOR:**
 1.VCC
 2.NC
 3.IRRX
 4.GND
 5.IRTX

J10  **PS/2 MOUSE CONNECTOR:**
 1.RED wire
 2.BLUE wire
 3.GREEN wire
 4.NC
 5.YELLOW wire

Intel Pentium® Processor / AMD K5 Installation						
	Clock/CPU Op.	JP4	JP5	JP6	JP19	JP20
	50/75 MHz	CLOSE	CLOSE	OPEN		
	60/90 MHz	CLOSE	OPEN	OPEN	1-2	1-2
	66/100 MHz	OPEN	OPEN	OPEN		
JP4	60/120 MHz	CLOSE	OPEN	OPEN	1-2	2-3
JP5	66/133 MHz	OPEN	OPEN	OPEN		
JP6	60/150 MHz	CLOSE	OPEN	OPEN	2-3	2-3
	66/166 MHz	OPEN	OPEN	OPEN		
JP19	60/180 MHz	CLOSE	OPEN	OPEN	2-3	1-2
JP20	66/200 MHz	OPEN	OPEN	OPEN		

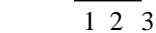

* Clock is System Clock.

* CPU OP. : CPU operation at 75, 90, 100 MHz, and etc.

Cyrix 6x86 / 6x86L Installation						
	CPU TYPE	JP4	JP5	JP6	JP19	JP20
	6x86-P120+	CLOSE	CLOSE	OPEN		
	6x86-P133+	OPEN	CLOSE	OPEN		
	6x86-P150+	CLOSE	OPEN	OPEN	1-2	2-3
	6x86-P166+	OPEN	OPEN	OPEN		
(Reserved)	6x86-P200+	OPEN	OPEN	CLOSE		

* 6x86-P120+ = 50/100MHz, 6x86-P133+ = 55/110MHz

* 6x86-P150+ = 60/120MHz, 6x86-P166+ = 66/133MHz

* 6x86-P200+ = 75/150MHz

Note 1 : If the Cyrix M1(6x86) is installed on the P55-TV motherboard, one of the two types of cooling fan(Model NO. 20750 is normal /standard fan/heatsink. Model NO. 20832 is 90 degree rotated fan.) must be selected correctly to match the regulator heatsink direction. **The P55-TV requires the use of Model NO : 20832.(Customer should request NMB-B50 fan).** Please Contact the Cyrix CPU suppliers for the details.

Note 2 : If the Cyrix 6x86-P200+ is installed on the P55-TV motherboard, there is a limitation : **It cannot work properly with the PCI 2.0 SCSI card.(For example : Adaptec AHA-2940/3940).** It will make your system hang or damage the data in the harddisk. Please do not install 6x86-P200+ with PCI 2.0 SCSI card on P55-TV motherboard.

But, You can choose PCI 2.1 SCSI card(For example : AHA-2940AU/2940UW). They do not have above problem.

2-3 System Memory Configuration

The P55-TV supports different type of settings for the system memory. Following figures provides all possible memory combinations. Please refer to **Appendix C: Memory Configuration Table** for the details.

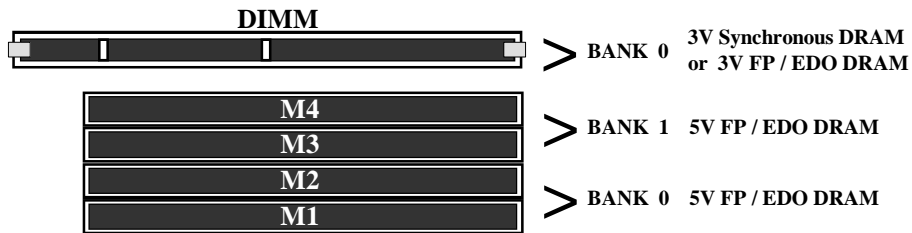

M1,M2 (BANK 0)	M3,M4 (BANK 1)	DIMM (BANK 0)	STATUS
Installed	None	None	OK
None	Installed	None	OK
None	None	Installed	OK
Installed	Installed	None	OK
None	Installed	Installed	OK
* Installed	None	Installed	Not Allowed
* Installed	Installed	Installed	Not Allowed

Note 2
Note 2

NOTE : 1. P55-TV supports both Fast Page DRAM and EDO DRAM SIMMs, but they can not be mixed in the same memory bank.

* 2. *Because the DIMM or (M1+M2) occupies the same memory block (BANK 0). So they cannot be installed at the same time.*

3. DIMM Module Specification : 3.3V / Unbuffered

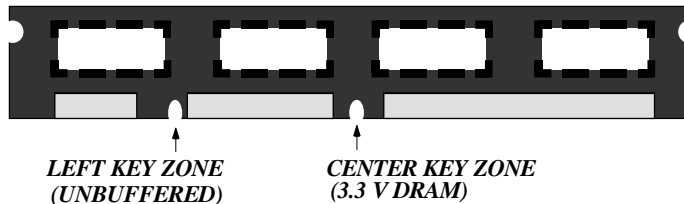

The P55-TV supports 168-pin DIMM module to extend system memory size. You can install (3.3V / UNBUFFERED) Fast Page, EDO or Synchronous DRAM.

When you have a DIMM module to plug into a 168-pin dual readout connector, you must make sure that the DIMM module is 3.3V/Unbuffered and supports Intel Pentium® Processor System.

2-4 Cache Memory Configuration

The second level (L2) of cache is installed in the motherboard to increase the system performance. The P55-TV supports different type of combinations for the cache installation. The **COAST 2.1** (Cache-On-A-STick. **The cache modules has a TAG SRAM.**) solution provides Onboard flexibility, allowing Onboard and modules to accommodate 256KB/512KB burst and piplined burst synchronous SRAM. Jumper JP15 and JP16 are used to set onboard synchronous SRAM for differential such combinations. Please refer to following configurations for the details.



SYN.CACHE Size	On Board (U27,U28)	On Module (SM1)	Jumper Setting	
			JP15	JP16
256KB	256KB	None	1-2	1-2
256KB	None	256KB	2-3	1-2
512KB	256KB	256KB	1-2	1-2
512KB	512KB	None	1-2	2-3
512KB	None	512KB	2-3	1-2

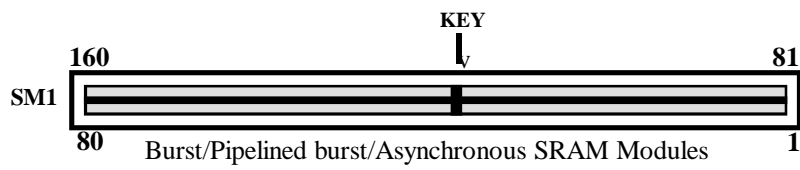

Figure 2-1 COAST MODULE

The **P55-TV** may have come with an optional **COAST** Module (Ref. Figure 2-1) to extend the onboard cache size from 256KB to 512KB (When the **P55-TV** had mounted 256 KB (32K*32 x 2 synchronous SRAM).

Note 1: When you have a cache module to plug into a 160-pin dual readout connector. **You must make sure that the cache module follow the specification of Intel COAST 2.0 or later version.** Please contact the modules supplier to avoid not working properly or damaging any modules circuits.

Note 2: Please be noted that some Synchronous SRAM can not support the **TWO BANK L2 CACHE**. For example, the SEC KM732V588G SRAM from SAMSUNG will not be able to support the **TWO BANK** function.

2-5 Integrated PCI Bridge

The **P55-TV** utilizes **Intel's 430VX PCIset** chipset to support Intel Pentium Processor PCI/ISA system. The Intel 82430VX PCIset chipset consists of the 82437VX system controller (TSC), two 82438VX Data Path (TDP) devices, and one 82371SB PCI ISA/IDE Accelerator (PIIX3) bridge chip. It provides an interface which translates CPU cycle into PCI bus cycle, and PCI burst read/write capability. In addition, it provides high performance PCI arbitor to support four PCI Masters, Rotating Priority Mechanism, and Hidden Arbitration Scheme Minimizes Arbitration Overhead.

There are four interrupts in each PCI slot : INTA#, INTB#, INTC#, and INTD#. Since the **P55-TV** adapts the PCI auto-configuration with the system BIOS Setup utility. When the system is turned on after adding a PCI add-in card, the BIOS automatically configure interrupts, DMA channels, I/O space, and other paramaters. You do not have to configure jumpers or worry potential resource conflicts. Because PCI cards use the same interrupt resource as ISA cards, you must specify the interrupt used by ISA add-in cards in the BIOS Setup utility.

If however, a "Legacy card" (such as plug paddle card and cable into the ISA slot.) is plugged in the system, modification in the **ROM SETUP UTILITY** become necessary. First, enter **PCI CONFIGURATION SETUP** utility from **ROM SETUP UTILITY** main menu to set the "**PCI IDE IRQ MAP TO : ISA**".

Secondly, you must enter **CHIPSET FEATURES SETUP UTILITY** from **ROM SETUP UTILITY** main menu and set the "**Onboard Primary PCI IDE: Disabled** and **Onboard Secondary PCI IDE: Disabled.**" When you plugg the PCI/ISA IDE card into the system, You should **Disabled Onboard Primary and Secondary PCI IDE** from **CHIPSET FEATURES SETUP UTILITY** too.

Some "Legacy card" (no paddle card and cable.) you can set the system interrupt request (IRQ) on the "Legacy card" (refer to user's manual of the card) to a proper system IRQ level (in general, card's Primary assigned to INTA and Secondary assigned to INTB). If the card is plugged into slot 1(marked PCI#1), you can not use second slot (marked PCI#2) because the Secondary INT signal takes INTB from the slot (refer to Page 3-12 for circuit diagram). The user then enter **PCI CONFIGURATION SETUP** utility from **ROM SETUP UTILITY** main menu and set the "**PCI IDE IRQ MAP TO : PCI-Slot 1**" (depend on the slot # where the Legacy card is plugged).

Chapter 3

AWARD BIOS Setup

Award's ROM BIOS provides a built-in Setup program which allows user to modify the basic system configuration and hardware parameters. The modified data will be stored in a battery-backed CMOS RAM so data will be retained even when the power is turned off. In general, the information saved in the CMOS RAM stay unchanged unless there is a configuration change in the system, such as a hard drive replacement or a new device installment.

It is possible for the CMOS battery to fail. This will cause data lose in CMOS only. If this does happen you will need to reconfigure your configuration parameters.

To enter Setup Program

Power on the computer and press key immediately. This will bring you into BIOS CMOSSETUPUTILITY.

ROM PCI/ISA BIOS(2A59GPAC) CMOSSETUPUTILITY AWARD SOFTWARE, INC.	
STANDARD CMOS SETUP	SUPERVISOR PASSWORD
BIOS FEATURES SETUP	USER PASSWORD
CHIPSET FEATURES SETUP	IDE HDD AUTO DETECTION
POWER MANAGEMENT SETUP	HDD LOW LEVEL FORMAT
PNP/PCI CONFIGURATION	SAVE & EXIT SETUP
INTEGRATED PERIPHERALS	EXIT WITHOUT SAVING
LOAD SETUP DEFAULTS	
ESC : QUIT	↑ ↓ → ← : SELECT ITEM
F10 : Save & Exit Setup	(Shift)F2 : Change Color
Time, Date, Hard Disk Type...	

Figure 3-1 CMOS SETUP UTILITY

The menu displays all the major selection items. Select the item you need to reconfigure. The selection is made by moving cursor (press any direction key) to the item and press the 'Enter' key. An on-line help message is displayed at the bottom of the screen as the cursor is moving to various items which provides a better understanding of each function. When a selection is made, the menu of selected item will appear so the user can modify associated configuration parameters.

3-2 CHAPTER 3

3-1 STANDARD CMOS SETUP

Choose "STANDARD CMOS SETUP" in the CMOS SETUP UTILITY Menu (Fig. 3-1). The STANDARD CMOS SETUP allows user to configure system setting such as the current date and time, type of hard disk drive installed, floppy drive type, and display type. Memory size is auto-detected by the BIOS and displayed for your reference. When a field is highlighted (use direction keys to move cursor and <Enter> key to select), the entry in the field will be changed by pressing <PgDn> or <PgUp> keys or user can enter new data directly from the keyboard.

ROM PCI/ISA BIOS (2A59GPAC)									
STANDARD CMOS SETUP									
AWARD SOFTWARE, INC.									
Date (mm:dd:yy) : Wed, Apr 17 1996									
Time (hh:mm:ss) : 14 : 30 : 50									
HARD DISKS	TYPE	SIZE	CYLS	HEAD	PRECOMP	LANDZONE	SECTORS	MODE	
Primary Master	:Auto	0	0	0	0	0	0	0	Auto
Primary Slave	:Auto	0	0	0	0	0	0	0	Auto
Secondary Master	:Auto	0	0	0	0	0	0	0	Auto
Secondary Slave	:Auto	0	0	0	0	0	0	0	Auto
Drive A : 1.44M, 3.5 in.									
Drive B : None				Base Memory : 640K					
Floppy 3 Mode Support : Disabled				Extended Memory : 31744K					
Video : EGA/VGA				Other Memory : 384K					
Halt On : All Errors				Total Memory : 32768K					
ESC : Quit		↑ ↓ ← → : Select Item		PU/PD/+/- : Modify					
F1 : Help		(Shift) F2 : Change Color							

Figure 3-2 STANDARD CMOS SETUP

NOTE: If hard disk Primary Master/Slave and Secondary Master/Slave use Auto, then the hard disk size and model will be auto-detected.

NOTE: The "Halt On :" field is to determine when to halt the system by the BIOS if an error occurs.

3-2 BIOS FEATURES SETUP

Selecting the "BIOS FEATURES SETUP" option in the CMOS SETUP UTILITY menu allows user to change system related parameters in the displayed menu. This menu shows all of the manufacturer's default values of the P55TV2. Again, user can move the cursor by pressing direction keys and <PgDn> or <PgUp> keys to modify the parameters. Pressing [F1] key to display help message of the selected item.

This setup program also provides 2 convenient ways to load the default parameter data from BIOS [F6] or CMOS [F7] area if the shown data is corrupted. This provides the system a capability to recover from any possible error.

ROMPCI/ISA BIOS(2A59GPAC)			
BIOSFEATURESETUP			
AWARDSOFTWARE,INC.			
Virus Warning	: Disabled	Video BIOS	Shadow : Enabled
CPU Internal Cache	: Enabled	C8000-CBFFF	Shadow : Disabled
External Cache	: Enabled	CC000-CFFFF	Shadow : Disabled
Quick Power On Self Test	: Enabled	D0000-D3FFF	Shadow : Disabled
Boot Sequence	: A,C, SCSI	D4000-D7FFF	Shadow : Disabled
Swap Floppy Drive	: Disabled	D8000-DBFFF	Shadow : Disabled
Boot Up Floppy Seek	: Enabled	DC000-DFFFF	Shadow : Disabled
Boot Up NumLock Status	: On		
Boot UP System Speed	: High		
Gate A20 option	: Fast		
Typematic Rate Setting	: Disabled		
Typematic Rate (Chars/Sec)	: 6		
Type matic Delay (Msec)	: 250		
Security Option	: Setup	Esc : Quit	↑ ↓ → ← : Select Item
PCI/VGA Palette Snoop	: Disabled	F1 : Help	PU/PD/+/- : Modify
OS Select For DRAM > 64MB	: Non-OS2	F5 : Old Values	(Shift)F2 : Color
		F7 : Load Setup Defaults	

Figure 3-3 BIOS FEATURES SETUP

Note: The Security Option contains "setup" and "system". The "setup" indicates that the password setting is for CMOS only while the "system" indicates the password setting is for both CMOS and system boot up.

- Virus Warning:** This category flashes on the screen. During and after the system boots up, any attempts to write to the boot sector or partition table of the hard disk drive will halt the system and an error message will appear. You should then run an anti-virus program to locate the virus. Keep in mind that this feature protects only the boot sector, not the entire hard drive. Default value is Disabled

Enabled : Activate automatically when the system boots up causing a warning message to appear when any attempts to access the boot sector or the hard disk partition table.

Disabled: No warning message to appear when any attempts to access the boot sector or the hard disk partition table.
- CPU Internal Cache/ External Cache:** These two categories speed up memory access. However, it depends on CPU/chipset design. The default value is Enabled. If your CPU is without Internal Cache then the item "CPU Internal Cache" will not show.

Enabled: Enable cache.

Disable : Disable cache.

3-4 CHAPTER 3

- **Quick Power On Self Test:** This category speeds up Power On Self Test (POST) after you power on the computer. If it is set to Enable, BIOS will shorten or skip some check items during POST.
Enabled : Enable quick POST.
Disabled: Normal POST.
- **Boot Sequence:** This category determines which drive is searched for first for the O/S(Operating System). Default value is A,C.
A,C : System will first search for the floppy disk drive then the hard disk drive.
C,A : System will first search for the hard disk drive then the floppy disk drive.
CDROM,C,A: System will first search for the CDROM drive (If the CDROM has a bootable CD title.) and second search for the hard disk drive then the floppy disk drive.
C,CDROM,A: System will first search for the hard disk driver and second search for the CDROM drive (If the CDROM has a bootable CD title.) then the floppy disk drive.
- **Swap Floppy Drive:** This will swap your physical drive letters A&B if you are using two floppy disks. Default value is Disabled.
Enabled : Floppy A & B will be swapped under the O/S.
Disabled: Floppy A & B will be not swapped.
- **Boot Up Floppy Seek:** During POST, BIOS will determine if the floppy disk drive installed is 40 or 80 tracks. Only 360K type is 40 tracks while 760K, 1.2M and 1.44M are all 80 tracks. The default value is Enabled.
Enabled : BIOS searches for the floppy disk drive to determine if it is 40 or 80 tracks.
Note that BIOS cannot tell from 720K, 1.2M or 1.44M drive type as they are all 80 tracks.
Disabled: BIOS will not search for the type of floppy disk drive by track number.
Note that there will not be any warning message if the drive installed is 360K.
- **Boot Up NumLock Status:** The default value is On.
On : Keypad is number keys.
Off : Keypad is arrow keys.
- **Boot UP System Speed:** Select the default system speed. The system will run at the selected speed after the system boots.
High: Set the speed to high.
Low : Set the speed to low.
- **Gate A20 Option:** This refers to the way the system addresses memory above 1MB (extended memory). The default value is Fast.
Normal : The A20 signal is controlled by keyboard controller or chipset hardware.
Fast : The A20 signal is controlled by Port 92 or chipset specific method.

- **Typematic Rate Setting:** This determines the typematic rate.
 - Enabled* : Enable typematic rate and typematic delay programming.
 - Disabled*: Disable typematic rate and typematic delay programming. The system BIOS will use default value of these 2 items and the default is controlled by keyboard.

- **Typematic Rate(Chars/Sec):**

6 : 6 characters per second.	8 : 8 characters per second.
10: 10 characters per second.	12: 12 characters per second.
15: 15 characters per second.	20: 20 characters per second.
24: 24 characters per second.	30: 30 characters per second.

- **Typematic Delay(Msec):** When holding a key, the time between the first and second character displayed is typematic delay.
 - 250 : 250msec.
 - 500 : 500 msec.
 - 750 : 750 msec.
 - 1000: 1000 msec.

- **Security Option:** This category allows you to limit access to the system and Setup, or just to Setup. The default value is Setup.
 - System*: The system will not boot and access to Setup if the correct password is not entered at the prompt.
 - Setup* : The system will boot, but the access to Setup will be denied if the correct password is not entered at the prompt.

- **PCI/VGA Palette Snoop:** This filed controls the ability of a primary PCI VGA controller to share a common palette (when a snoop write cycles) with an ISA video card. The default value is Disabled.
 - Enabled*: If an ISA card connects to a PCI VGA card via the VESA connector and the ISA card connects to VGA monitor and that ISA card uses the RAMDAC of PCI card, the PCI/VGA Palette Snoop is enabled.
 - Disabled*: Disable the VGA card Palette snoop function.

- **Video BIOS Shadow:** It determines whether video BIOS will be copied to RAM, however, it is optional from chipset design. Video Shadow will increase the video speed.
 - Enabled* : Video shadow is enabled.
 - Disabled*: Video shadow is disabled.

3-6 CHAPTER 3

- **C8000 - CBFFF Shadow :**
- CC000 - CFFFF Shadow:**
- D0000 - D3FFF Shadow:**
- D4000 - D7FFF Shadow:**
- D8000 - DBFFF Shadow:**
- DC000 - DFFFF Shadow:**

These categories determine whether other expansion card optional ROM will be copied to RAM by 16K byte or 32K byte perunit and the size depends on chipset. If you install other expansion cards with ROMs on them, you will need know which addresses the ROMs used to shadow themselves specifically.

Enabled : Optional shadow is enabled.

Disabled: Optional shadow is disabled.

3-3 CHIPSET FEATURES SETUP

Choose the "CHIPSET FEATURES SETUP" in the CMOS SETUP UTILITY menu to display the following menu.

ROMPCI/ISA BIOS(2A59GPAC) CHIPSETFEATURESETUP AWARDSOFTWARE,INC.			
Auto Configuration	: Enabled	Peer Concurrency	: Enabled
DRAM Timing	: 60 ns	Chipset NA# Asserted	: Enabled
DRAM RAS# Precharge Time	: 3	Passive Release	: Enabled
DRAM R/W Leadoff Timing	: 6	Delayed Transaction	: Disabled
Fast RAS to CAS Delay	: 3		
DAM Read Burst (EDO/FP)	: x222/x333		
DRAM Write Burst Timing	: x222		
Fast MA to RAS# Delay CLK	: 1		
Fast EDO Path Select	: Disabled		
Refresh RAS# Assertion	: 4 Clks		
ISA Bus Clock	: PCICLK/4		
Pipeline Cache Timing	: Fastest		
System BIOS Cacheable	: Disabled		
Video BIOS Cacheable	: Enabled		
8 Bit I/O Recovery Time	: 1	Esc : Quit	↑ ↓ → ← : Select Item
16 Bit I/O Recovery Time	: 1	F1 : Help	PU/PD/+/- : Modify
Memory Hole At 15M-16M	: Disabled	F5 : Old Values	(Shift)F2 : Color
		F7 : Load Setup Defaults	

Figure 3-4 CHIPSET FEATURES SETUP

- **Auto Configuration:** This Category allows you to set the DRAM timing. The default value is Enabled. When disabled this field, you can select the different DRAM timings supported by chipsets.

Note: When you insert slower memory modules in the system and set a faster timing, maybe, the system will hang up.

- **DRAM Timing:** The default value is 60ns.
60ns : 2 (faster) Burst Wait State, for 60~70ns Fast Page Mode/EDO DRAM.
70ns : 3 (slower) Burst Wait State, for 70ns Fast Page Mode/EDO DRAM.
- **Video BIOS Cacheable:** The default value is Enabled.
Enabled : Enable the Video BIOS Cacheable to speed up the VGA Performance.
Disabled: Disable the Video BIOS Cacheable function.
- **8/16 Bit I/O Recovery Time:** The default value is 1.
8 Bit I/O Recovery Time: This field defines the recovery time from 1 to 8 for 8-bit I/O.
16 Bit I/O Recovery Time: To define the recovery time from 1 to 4 for 16-bit I/O.
- **Memory Hole at 15M-16M:** The default value is Disabled.
Disabled: Normal Setting.
Enabled : enable the main memory (15~16MB) remap to ISA BUS. This feature reserves 15MB to 16MB memory address space to ISA expansion card that specifically requires this setting.
- **Peer Concurrency:** The default value is Enabled.
- **Chipset NA# Asserted:** The default value is Enabled.
- **Passive Release:** The default value is Enabled.
- **Delay Transaction:** The default value is Disabled.

3-4 POWER MANAGEMENT SETUP

Choose the "POWER MANAGEMENT SETUP" in the CMOS SETUP UTILITY to display the following screen. This menu allows user to modify the power management parameters and IRQ signals. In general, these parameters should not be changed unless it is absolutely necessary.

ROM PCI/ISA BIOS POWER MANAGEMENT SETUP AWARD SOFTWARE, INC.		
Power Management	: User Define	** Power Down & Resume Events **
PM Control by APM	: Yes	IRQ3 (COM 2) : ON
Video off Method	: V/H SYNC+Blank	IRQ4 (COM 1) : ON
MODEM Use IRQ	: 3	IRQ5 (LPT 2) : ON
		IRQ6 (Floppy Disk) : ON
Doze Mode	: Disable	IRQ7 (LPT 1) : OFF
Standby Mode	: Disabled	IRQ8 (RTC Alarm) : OFF
Suspend Mode	: Disabled	IRQ9 (IRQ2 Redir) : ON
HDD Power Down	: 15 Min	IRQ10 (Reserved) : ON
		IRQ11 (Reserved) : ON
** Wake Up Events In Doze & Standby **		IRQ12 (PS/2 Mouse) : ON
IRQ3 (Wake-Up Event)	: ON	IRQ13 (Coprocessor) : ON
IRQ4 (Wake-Up Event)	: ON	IRQ14 (Hard Disk) : ON
IRQ8 (Wake-Up Event)	: ON	IRQ15 (Reserved0) : ON
IRQ12 (Wake-Up Event)	: ON	
		Esc : Quit ↑ ↓ → ← : Select Item
		F1 : Help PU/PD/+/- : Modify
		F5 : Old Values (Shift)F2: Color
		F7 : Load Setup Defaults

Figure 3-5 POWER MANAGEMENT SETUP

Again, user can move the cursor by pressing direction keys to the field that needs to be modified and press <PgDn> or <PgUp> to alter item selection. You can only change the content of **Doze Mode**, **Standby Mode**, and **Suspend Mode** when the **Power Management** is set to **User Define**.

Note: When the computer enters the suspend mode (setting the suspend mode valid range from 1 minute up to 1 hour) activated by the BIOS Power Management, you need to RUN a program POWER.EXE under DOS root, or need to add DEVICE=C:\DOS\POWER.EXE in your CONFIG.SYS. This will keep the system time updating normally when the system wake up from the suspend mode. The suspend mode for Windows[®] 95 or windows 3.1x must have windows APM feature installed. Choose "Advanced Power Management" item from "system device". The "system device" field was from "system" icon in the "control panel."

3-4-1 The Description of the Power Management

A. Power Management mode selection :

Disabled : The system operates in NORMAL conditions (Non-GREEN) and the Power Management function is disabled.

Max. saving: This mode will maximize the power saving capability.

Min. saving: This mode will minimize the power saving capability.

User Define: Allows user to define time-out parameters to control the power saving mode. Refer to item B shown below.

B. Time-out parameters :**HDDStandby**

HDD Standby timer can be set from 1 to 15 minute(s).

System Doze

The "System Doze" mode timer starts to count when there is no "PM events" occurred. The valid time-out setting is from 1 minute up to 1 hour.

System Standby

The "Standby" mode timer starts to count when "System Doze" mode timer timed out and no "PM events" occurred. Valid range is from 1 minute up to 1 hour.

System Suspend

This function works only when the Pentium® Processor is installed. The timer starts to count when "System Standby" mode timer is timed out and no "PM Events" occurred. Valid range is from 1 minute up to 1 hour.

3-4-2 Description of the Green Functions

The P55TV2 supports HDD Power Down, Doze and standby power saving functions when Intel Pentium® Processor is installed. In addition, the suspend function is supported when the J2's sleep (refer to Figure 1-1) is closed to enter the green function. The detailed descriptions of these functions are provided in the next page.

HDD Power Down

When system stop reading or writing HDD, the timer starts to count. The system will cut off the HDD power when timer runs out of time. The system will not resume operation until either a read from or a write to HDD command is executed again.

Doze Mode

The system hardware will drop down CPU clock from normal working speed when Doze mode time-out occurs.

Standby Mode

When the system standby mode timer times-out, it will enter the standby mode and retain CPU at slow working speed. The screen will be blanked out.

Suspend Mode

When the system suspend timer times-out, the system will enter the suspend mode and the chipset will stop CPU clock immediately. The power consumption in Suspend Mode is lower than in standby mode. The screen is also blanked out.

PM Events:

AWARD BIOS defines 15 PM Events in the power management mode (Doze, standby & suspend). The user can initialize any PM Events to be "Enable" or "Disable". When the system detects all of the enabled events, do not have any activity. It will start the system Doze timer first if the "Power Management" is not "Disabled". Once the system Doze timer is timed out, it will process doze power saving procedure by starting the system standby timer. When the standby timer run out and all of the "Enabled" events remains silent, the system will enter the standby mode. By now, the system will not only process the standby power saving procedures but also start the system suspend timer. When the suspend timer times out, all of the CPU clock will stop by dropping system clock down to zero and remains this way until any one of the "Enabled" event occurs.

3-5 PnP/PCI CONFIGURATION

The PnP/PCI configuration program is for the user to modify the PCI/ISA IRQ signals when various PCI/ISA cards are inserted in the PCI or ISA slots.

WARNING : Conflicting IRQs may cause the system to not find certain devices

ROM PCI/ISA BIOS(2A59CPAC)			
PNP/PCI CONFIGURATION			
AWARD SOFTWARE, INC.			
Resources Controlled By	: Manual	PCI IRQ Activated By	: Level
Reset Configuration Data	: Disabled	PCI IDE IRQ Map To	: PCI-AUTO
		Primary IDE INT#	: A
		Secondary IDE INT#	: B
		Used MEM base addr	: N/A
IRQ-3 assigned to	: Legacy ISA		
IRQ-4 assigned to	: Legacy ISA		
IRQ-5 assigned to	: PCI/ISA PnP		
IRQ-7 assigned to	: PCI/ISA PnP		
IRQ-9 assigned to	: PCI/ISA PnP		
IRQ-10 assigned to	: PCI/ISA PnP		
IRQ-11 assigned to	: PCI/ISA PnP		
IRQ-12 assigned to	: PCI/ISA PnP		
IRQ-14 assigned to	: PCI/ISA PnP		
IRQ-15 assigned to	: PCI/ISA PnP		
DMA-0 assigned to	: PCI/ISA PnP		
DMA-1 assigned to	: PCI/ISA PnP		
DMA-3 assigned to	: PCI/ISA PnP	ESC : Quit	↑ ↓ ← → : Select Item
DMA-5 assigned to	: PCI/ISA PnP	F1 : Help	PU/PD/+/-: Modify
DMA-6 assigned to	: PCI/ISA PnP	F5 : No Change	(Shift) F2: Color
DMA-7 assigned to	: PCI/ISA PnP	F7 : Load Setup Defaults	

Figure 3-6 PCI CONFIGURATION SETUP

- **Resource Controlled By:** The default value is Manual.
 - Manual:** The PNP Card's resource will be controlled manually. You can set which IRQ-X and DMA-X are assigned to PCI/ISA PnP or Legacy ISA Cards.
 - Auto:** If your ISA card and PCI card are all PnP cards, BIOS will assign the interrupt resource automatically.

- **Reset Configuration Data:** The default value is Disabled.
Disabled: Normal Setting.
Enabled : If you had plugged some Legacy cards in the system and they were recorded into ESCD(Extended System Configuration Data), you can set this field to Enabled to clear ESCD.

- **PCIIDE IRQ Map To:** The default value is PCI-AUTO
 When you have true PCI card(s) plugged into the system, you will not need to change any thing here in the **SETUP** program. However, if you do not know whether you have true PCI card or not, please refer to your PCI card user's manual for the details.

When you have a Legacy card (described in section 2-6) to be plugged into the system, a proper setting is extremely important or it may cause the system hang. The diagram shown below tells you how the Rotating Priority Mechanism is designed.

- **Used MEM base addr and Used MEM Length : The default value is N/A.**

The Used MEM base addr (CB00, CC00, D000, D400, D800, DC00) and Used MEM Length (8K, 16K, 32K, 64K) were to support some specific ISA Legacy cards with requested memory space below 1M address. Now with these two functions, users can define where the used memory address is located and its length of the legacy area that is used by the legacy device to avoid the memory space conflict. For example, if users select "D000" for "Used MEM base addr" and "16K" for "Used MEM Length," that means the address region D0000H-D3FFFH is occupied by ISA legacy cards, and thus BIOS will not assign this region for PnP/ISA and PCI cards.

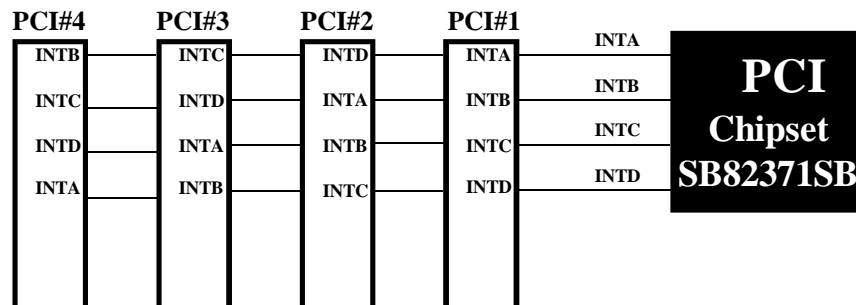

Figure 3-7 The Combination of PCI INT# lines

3-6 INTEGRATED PERIPHERALS

ROM PCI/ISA BIOS(2A59GPAC)		INTEGRATED PERIPHERALS	
WARD SOFTWARE, INC.			
IDE HDD Block Mode	: Enabled	Onboard IR Controller	: Disabled
IDE Primary Master PIO	: Auto		
IDE Primary Slave PIO	: Auto		
IDE Secondary Master PIO	: Auto		
IDE Secondary Slave PIO	: Auto		
Onboard Primary PCI IDE	: Enabled		
Onboard Secondary PCI IDE	: Enabled		
PCI Slot IDE 2nd Channel	: Enabled		
USB Controller	: Disabled		
KBC input clock	: Auto		
Onboard FDC Controller	: Enabled		
Onboard Serial Port 1	: Auto		
Onboard Serial Port 2	: Auto		
Onboard Parallel Port	: 378/IRQ7	ESC : Quit	↑ ↓ → ← : Select Item
Parallel Port Mode	: ECP+EPP	F1 : Help	PU/PD/+/- : Modify
ECP Mode Use DMA	: 3	F5 : No Change	(Shift) F2 : Color
Parallel Port EPP Type	: EPPI.9	F7 : Load Setup Defaults	

Note: If you do not use the Onboard IDE connector, then use On-card (PCI or ISA card) IDE connector. You will set Onboard Primary PCI IDE: Disabled and Onboard Secondary PCI IDE: Disabled from CHIPSET FEATURES SETUP UTILITY. The Onboard PCI IDE cable should be equal to or less than 18 inches (45 cm.).

- IDE HDD Block Mode:** The default value is Enabled.
Enabled : Enable IDE HDD Block Mode to provide higher HDD transfer rate.
Disabled: Disable IDE HDD Block Mode.
- PCI Slot IDE 2nd Channel:** The default value is Enabled.
Enabled : Enable secondary IDE port and BIOS will assign IRQ15 for this port.
Disabled : Disable secondary IDE port and IRQ15 is available for other device.
- Onboard Primary PCI IDE:** The default value is Enabled.
Enabled : Enable Onboard IDE primary port.
Disabled : Disable Onboard IDE primary port, when using On-card (PCI or ISA card) IDE connector.
- Onboard Secondary PCI IDE:** The default value is Enabled.
Enabled : Enable Onboard IDE secondary port.
Disabled : Disable Onboard IDE secondary port when using On-card (PCI or ISA card) IDE connector.

- **IDE Primary Master PIO:** The default value is Auto.
 - Auto* : BIOS will automatically detect the Onboard Primary Master PCI IDE HDD Accessing mode.
 - Mode0~4* : Manually set the IDE Accessing mode.

- **IDE Primary Slave PIO:** The default value is Auto.
 - Auto* : BIOS will automatically detect the Onboard Primary Slave PCI IDE HDD Accessing mode.
 - Mode0~4* : Manually set the IDE Accessing mode.

- **IDE Secondary Master PIO:** The default value is Auto.
 - Auto* : BIOS will automatically detect the Onboard Secondary Master PCI IDE HDD Accessing mode.
 - Mode0~4* : Manually set the IDE Accessing mode.

- **IDE Secondary Slave PIO:** The default value is Auto.
 - Auto* : BIOS will automatically detect the Onboard Secondary Slave PCI IDE HDD Accessing mode.
 - Mode0~4* : Manually set the IDE Accessing mode.

- **Onboard FDC Controller:** The default value is Enabled.
 - Enabled* : Enable the Onboard SMC CHIP's floppy drive interface controller.
 - Disabled* : Disable the Onboard SMC CHIP's floppy drive interface controller. when using On-card ISA FDC's controller.

- **Onboard UART 1:** This field allows the user to select the serial port. The default value is 3F8H/IRQ4.
 - COM1:* Enable Onboard Serial port 1 and address is 3F8H/IRQ4.
 - COM2:* Enable Onboard Serial port 1 and address is 2F8H/IRQ3.
 - COM3:* Enable Onboard Serial port 1 and address is 3E8H/IRQ4.
 - COM4:* Enable Onboard Serial port 1 and address is 2E8H/IRQ3.
 - Disabled:* Disable Onboard SMC CHIP's Serial port 1.

- **Onboard UART 2:** This field allows the user to select the serial port. The default value is 2F8H/IRQ3.
 - COM1:* Enable Onboard Serial port 2 and address is 3F8H/IRQ4.
 - COM2:* Enable Onboard Serial port 2 and address is 2F8H/IRQ3.
 - COM3:* Enable Onboard Serial port 2 and address is 3E8H/IRQ4.
 - COM4:* Enable Onboard Serial port 2 and address is 2E8H/IRQ3.
 - Disabled:* Disable Onboard SMC CHIP's Serial port 2.

- **Onboard UART 2 Mode:** The default value is standard. This field allows the User to select the COM2 port that can support a serial Infrared Interface.
Standard: Support a Serial Infrared Interface IrDA.
HPSIR: Support a HP Serial Infrared Interface format.
ASKIR: Support a Sharp Serial Infrared Interface format.
- **Onboard Parallel port:** This field allows the user to select the LPT port. The default value is 378H/IRQ7.
 - 378H** : Enable Onboard LPT port and address is 378H and IRQ7
 - 278H** : Enable Onboard LPT port and address is 278H and IRQ5.
 - 3BCH** : Enable Onboard LPT port and address is 3BCH and IRQ7.
 - Disabled** : Disable Onboard SMC CHIP's LPT port.

NOTE: Parallel Port address is 378H/3BCH that selects the routing of IRQ7 for LPT1.
Parallel Port address is 278H that selects the routing of IRQ5 for LPT1.

- **Parallel port Mode:** This field allows the user to select the parallel port mode. The default value is ECP+EPP.
 - Normal** : Standard mode. IBM PC/AT Compatible bidirectional parallel port.
 - EPP** : Enhanced Parallel Port mode.
 - ECP** : Extended Capabilities Port mode.
 - EPP+ECP** : ECP Mode & EPP Mode.

ECP Mode USE DMA: This field allows the user to select DMA1 or DMA3 for the ECP mode. The default value is DMA3.

- DMA1** : The field selects the routing of DMA1 for the ECP mode.
- DMA3** : The field selects the routing of DMA3 for the ECP mode.

3-7 LOADSETUPDEFAULTS

The "LOAD SETUP DEFAULTS" function loads the system default data directly from ROM and initializes the associated hardware properly. This function will be necessary only when the system CMOS data is corrupted.

ROM PCI/ISA BIOS(2A59GPAC) CMOS SETUP UTILITY AWARD SOFTWARE, INC.	
STANDARD CMOS SETUP BIOS FEATURES SETUP CHIPSET FEATURES SETUP POWER MANAGEMENT SETUP PNP/PCI CONFIGURA INTEGRATED PERIPH LOAD SETUP DEFAULTS	SUPERVISOR PASSWORD USER PASSWORD IDE HDD AUTO DETECTION HDD LOW LEVEL FORMAT SETUP SAVING <div style="border: 2px solid black; padding: 2px; text-align: center; margin: 10px 0;"> Load SETUP Default (Y/N)? Y </div>
ESC: QUIT ↑ ↓ → ← :SELECT ITEM F10: Save & Exit Setup (Shift)F2 :Change Color	
Load Setup Defaults Except Standard COMS SETUP	

Figure 3-8 LOAD SETUP DEFAULT

3-8 CHANGE SUPERVISOR or USER PASSWORD

To change the password, choose the '**SUPERVISOR PASSWORD** or **USER PASSWORD**' option from the **CMOS SETUP UTILITY** menu and press [Enter].

NOTE : Either "Setup" or "System" must be selected in the "Security Option" of the **BIOS FEATURES SETUP** menu (Refer to Figure 3-3 for the details).

1. If CMOS is corrupted or the option is not used, a default password stored in the ROM will be used. The screen will display the following message:

Enter Password:

Press the [Enter] key to continue after proper password is given.

2. If CMOS is corrupted or the option was used earlier and the user wish to change default password, the **SETUP UTILITY** will display a message and ask for a confirmation.

Confirm Password:

3. After pressing the [Enter] key (ROM password if the option was not used) or current password (user-defined password), the user can change the password and store new one in CMOS RAM. A maximum of 8 characters can be entered.

3-9 IDE HDD AUTO DETECTION

The "IDE HDD AUTO DETECTION" utility is a very useful tool especially when you do not know which kind of hard disk type you are using. You can use this utility to detect the correct disk type installed in the system automatically. **But now** you can set **HARD DISK TYPE** to **Auto** in the **STANDARD CMOS SETUP**. You do not need the "IDE HDD AUTO DETECTION" utility. The BIOS will Auto-detect the hard disk size and model on display during POST.

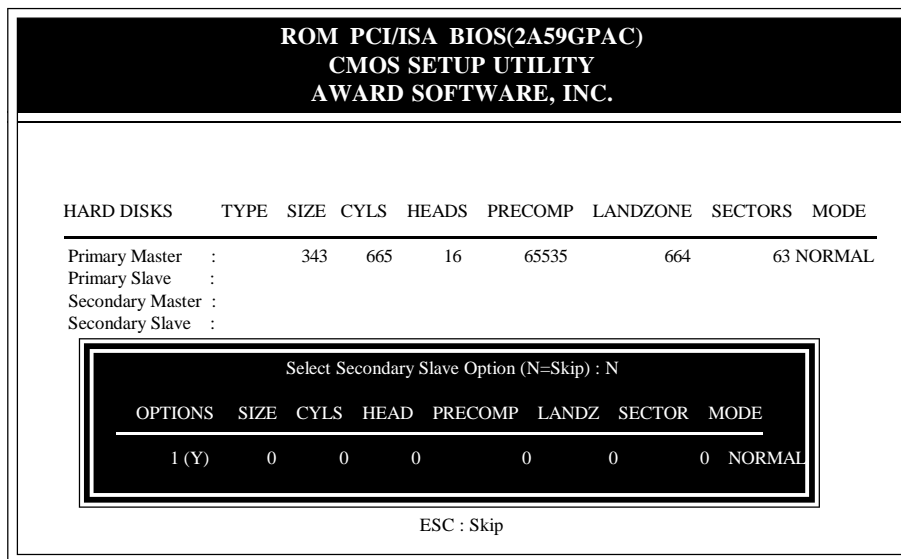

Figure 3-9 IDE HDD AUTO DETECTION

NOTE: HDD Modes

The Award BIOS supports 3 HDD modes : NORMAL, LBA & LARGE NORMAL mode.

Generic access mode in which neither the BIOS nor the IDE controller will make any transformations during accessing.

The maximum numbers of cylinders, heads & sectors for NORMAL mode are 1024, 16 & 63.

$$\begin{array}{r}
 \text{no. Cylinder} \quad (1024) \\
 \times \text{ no. Head} \quad (16) \\
 \times \text{ no. Sector} \quad (63) \\
 \hline
 \times \text{ no. per sector} \quad (512) \\
 \hline
 528 \text{ Megabytes}
 \end{array}$$

If user sets his HDD to NORMAL mode, the maximum accessible HDD size will be 528 Megabytes even though its physical size may be greater than that!

LBA (Logical Block Addressing) mode: A new HDD accessing method to overcome the 528 Megabyte bottleneck.

The number of cylinders, heads & sectors shown in setup may not be the number physically contained in the HDD.

During HDD accessing, the IDE controller will transform the logical address described by sector, head & cylinder into its own physical address inside the HDD.

The maximum HDD size supported by LBA mode is 8.4 Gigabytes which is obtained by the following formula:

$$\begin{array}{r}
 \text{no. Cylinder} \quad (1024) \\
 \times \text{no. Head} \quad (255) \\
 \times \text{no. Sector} \quad (63) \\
 \hline
 \times \text{bytes per sector} \quad (512) \\
 \hline
 8.4 \text{ Gigabytes}
 \end{array}$$

LARGE mode: Extended HDD access mode supported by Award Software.

Some IDE HDDs contain more than 1024 cylinder without LBA support (in some cases, user does not want LBA). The Award BIOS provides another alternative to support these kinds of LARGE mode:

CYLS.	HEADS	SECTOR	MODE
1120	16	59	NORMAL
560	32	59	LARGE

BIOS tricks DOS (or other OS) that the number of cylinders is less than 1024 by dividing it by 2. At the same time, the number of heads is multiplied by 2. A reverse transformation process will be made inside INT 12h in order to access the right HDD address!

Maximum HDD size:

$$\begin{array}{r}
 \text{no. Cylinder} \quad (1024) \\
 \times \text{no. Head} \quad (32) \\
 \times \text{no. Sector} \quad (63) \\
 \hline
 \times \text{bytes per sector} \quad (512) \\
 \hline
 1 \text{ Gigabytes}
 \end{array}$$

Note:

To support LBA or LARGE mode of HDDs, there must be some softwares involved. All the software is located in the Award HDD Service Routine (1NT 13h). It may fail to access a HDD with LBA (LARGE) mode selected if you are running under an Operating System which replaces the whole 1NT 13h. UNIX operating systems do not support either LBA or LARGE and must utilize the Standard mode. UNIX can support drives larger than 528MB.

3-10 HDD LOW LEVEL FORMAT

Interleave

Select the interleave number of the hard disk drive that you wish to perform a low level format on. You may select from 1 to 8. Check the documentation that came with the drive for the correct interleave number, or select 0 for automatic detection.

Auto scan bad track

This allows the utility to scan first then format by each track.

Start

Press <Y> to start low level format.

3-11 SAVE & EXIT SETUP

The "SAVE & EXIT SETUP" option will bring you back to boot up procedure with all changes you just recorded in the CMOS RAM.

3-12 EXIT WITHOUT SAVING

The "EXIT WITHOUT SAVING" option will bring you back to normal boot up procedure without saving any data into CMOS RAM. All old data in the CMOS will not be destroyed.

Chapter 4

Technical Information

4-1 I/O & MEMORY MAP

MEMORY MAP

Address Range	Size	Description
[00000-7FFFF]	512K	Conventional memory
[80000-9FBFF]	127K	Extended Conventional memory
[9FC00-9FFFF]	1K	Extended BIOS data area if PS/2 mouse is installed
[A0000-C7FFF]	160K	Available for Hi DOS memory
[C8000-DFFFF]	96K	Available for Hi DOS memory and adapter ROMs
[E0000-EEFFF]	60K	Available for UMB
[EF000-EFFFF]	4K	Video service routine for Monochrome & CGA adaptor
[F0000-F7FFF]	32K	BIOS CMOS setup utility
[F8000-FCFFF]	20K	BIOS runtime service routine (2)
[FD000-FDFFF]	4K	Plug and Play ESCD data area
[FE000-FFFFF]	8K	BIOS runtime service routine (1)

I/O MAP

[000-01F]	DMA controller.(Master)
[020-021]	INTERRUPT CONTROLLER.(Master)
[022-023]	CHIPSET control registers. I/O ports.
[040-05F]	TIMER control registers.
[060-06F]	KEYBOARD interface controller.(8042)
[070-07F]	RTC ports & CMOS I/O ports.
[080-09F]	DMA register.
[0A0-0BF]	INTERRUPT controller.(Slave)
[0C0-0DF]	DMA controller.(Slave)
[0F0-0FF]	MATH COPROCESSOR.
[1F0-1F8]	HARD DISK controller.
[278-27F]	PARALLEL port 2.
[2B0-2DF]	GRAPHICS adapter controller.
[2F8-2FF]	SERIAL port 2.
[360-36F]	NETWORK ports.
[378-37F]	PARALLEL port 1.
[3B0-3BF]	MONOCHROME & PARALLEL port adapter.
[3C0-3CF]	EGA adapter.
[3D0-3DF]	CGA adapter.
[3F0-3F7]	FLOPPY DISK controller.
[3F8-3FF]	SERIAL port 1.

4-2 TIME & DMA CHANNELS MAP

TIME MAP:	TIMER Channel 0	System timer interrupt.
	TIMER Channel 1	DRAM REFRESH request.
	TIMER Channel 2	SPEAKER tone generator.
DMA CHANNELS :	DMA Channel 0	Available.
	DMA Channel 1	Onboard ECP (Option).
	DMA Channel 2	FLOPPY DISK (SMC CHIP).
	DMA Channel 3	Onboard ECP (default).
	DMA Channel 4	Cascade for DMA controller 1.
	DMA Channel 5	Available.
	DMA Channel 6	Available.
	DMA Channel 7	Available.

4-3 INTERRUPT MAP

NMI :	Parity check error.
IRQ (H/W) :	0 System TIMER interrupt from TIMER 0.
	1 KEYBOARD output buffer full.
	2 Cascade for IRQ 8-15.
	3 SERIAL port 2.
	4 SERIAL port 1.
	5 PARALLEL port 2.
	6 FLOPPY DISK (SMC CHIP).
	7 PARALLEL port 1.
	8 RTC clock.
	9 Available.
	10 Available.
	11 Available.
	12 PS/2 Mouse.
	13 MATH coprocessor.
	14 Onboard HARD DISK(IDE1) channel.
	15 Onboard HARD DISK(IDE2) channel.

4-4 RTC & CMOS RAM MAP

RTC & CMOS :	00	Seconds.
	01	Second alarm.
	02	Minutes.
	03	Minutes alarm.
	04	Hours.
	05	Hours alarm.
	06	Day of week.
	07	Day of month.
	08	Month.
	09	Year.
	0A	Status register A.
	0B	Status register B.
	0C	Status register C.
	0D	Status register D.
	0E	Diagnostic status byte.
	0F	Shutdown byte.
	10	FLOPPY DISK drive type byte.
	11	Reserve.
	12	HARD DISK type byte.
	13	Reserve.
	14	Equipment type.
	15	Base memory low byte.
	16	Base memory high byte.
	17	Extension memory low byte.
	18	Extension memory high byte.
	19-2d	
	2E-2F	
	30	Reserved for extension memory low bytw.
	31	Reserved for extension memory high byte.
	32	DATE CENTURY byte.
	33	INFORMATION FLAG.
	34-3F	Reserve.
	40-7F	Reserved for CHIPSET SETTING DATA.

APPENDIX A: POST CODES

ISA POST codes are typically output to port address 80h.

POST(hex)	DESCRIPTION
-----------	-------------

01-02	Reserved.
-------	-----------

C0	Turn off OEM specific cache, shadow.
----	--------------------------------------

03	1.Initialize EISA registers (EISA BIOS only). 2.Initialize all the standard devices with default values Standard devices includes. -DMA controller (8237). -Programmable Interrupt Controller (8259). -Programmable Interval Timer (8254). -RTC chip.
----	--

04	Reserved
----	----------

05	1.Keyboard Controller Self-Test. 2.Enable Keyboard Interface.
----	--

06	Reserved.
----	-----------

07	Verifies CMOS's basic R/W functionality.
----	--

C1	Auto-detection of onboard DRAM & Cache.
----	---

C5	Copy the BIOS from ROM into E0000-FFFFFF shadow RAM so that POST will go faster.
----	--

08	Test the first 256K DRAM.
----	---------------------------

09	OEM specific cache initialization. (if needed)
----	--

0A	1.Initialize the first 32 interrupt vectors with corresponding Interrupt handlers Initialize INT no from 33-120 with Dummy (Suprious) Interrupt Handler. 2.Issue CUID instruction to identify CPU type. 3.Early Power Management initialization. (OEM specific)
----	---

0B	1.Verify the RTC time is valid or not. 2.Detect bad battery. 3.Read CMOS data into BIOS stack area. 4.PnP initializations including. (PnP BIOS only) -Assign CSN to PnP ISA card. -Create resource map from ESCD. 5.Assign IO & Memory for PCI devices. (PCI BIOS only)
----	---

POST(hex) DESCRIPTION

0C	Initialization of the BIOS Data Area. (40:00 - 40:FF)
0D	<ol style="list-style-type: none"> 1.Program some of the Chipset's value according to Setup. (Early Setup Value Program) 2.Measure CPU speed for display & decide the system clock speed. 3.Video initialization including Monochromc, CGA, EGA/VGA. If no display device found, the speaker will beep.
0E	<ol style="list-style-type: none"> 1.Test video RAM. (If Monochromc display device found) 2.Show messages including. <ul style="list-style-type: none"> -Award Logo, Copyright string, BIOS Data code & Part No. -OEM specific sign on messages. -Energy Star Logo. (Green BIOS ONLY) -CPU brand, type & speed. -Test system BIOS checksum. (Non-Compress Version only)
0F	DMA channel 0 test.
10	DMA channel 1 test.
11	DMA page registers test.
12-13	Reserved.
14	Test 8254 Timer 0 Counter 2.
15	Test 8259 interrupt mask bits for channel 1.
16	Test 8259 interrupt mask bits for channel 2.
17	Reserved.
19	Test 8259 functionality.
1A-1D	Reserved.
1E	If EISA NVM checksum is good, exccute EISA initialization. (EISA BIOS only)
1F-29	Reserved.
30	Detect Base Memory & Extended Memory Size.
31	<ol style="list-style-type: none"> 1.Test Base Memory from 256K to 640K. 2.Test Extended Memory from 1M to the top of memory.

4-6 CHAPTER 4

POST(hex)	DESCRIPTION
32	1.Display the Award Plug & Play BIOS Extension message. (PnP BIOS only) 2.Program all onboard super I/O chips (if any) including COM ports, LPT ports, FDD port ... according to setup value.
33-3B	Reserved.
3C	Set flag to allow users to enter CMOS Setup Utility.
3D	1.Initialize Keyboard. 2.Install PS2 mouse.
3E	Try to turn on Level 2 cache. Note : Some chipset may need to turn on the L2 cache in this stage. But usually, the cache is turn on later in POST 61h.
3F-40	Reserved.
BF	1.Program the rest of the Chipset's value according to Setup. (Later Setup Value Program) 2.If auto-configuration is enabled, programmed the chipset with pre-defined Values.
41	Initialize floppy disk drive controller.
42	Initialize Hard drive controller.
43	If it is a PnP BIOS, initialize serial & parallel ports.
44	Reserved.
45	Initialize math coprocessor.
46-4D	Reserved.
4E	If there is any error detected (such as video, kb...), show all the error messages on the screen & wait for user to press <F1> key.
4F	1.If password is needed, ask for password. 2.Clear the Energy Star Logo. (Green BIOS only)
50	Write all CMOS values currently in the BIOS stack area back into the CMOS.
51	Reserved.

POST(hex) DESCRIPTION

- 52** 1.Initialize all ISA ROMs.
 2.Later PCI initializations. (PCI BIOS only)
 -assign IRQ to PCI devices.
 -initialize all PCI ROMs.
 3.PnP Initializations. (PnP BIOS only)
 -assign IO, Memory, IRQ & DMA to PnP ISA devices.
 -initialize all PnP ISA ROMs.
 4.Program shadows RAM according to Setup settings.
 5.Program parity according to Setup setting.
 6.Power Management Initialization.
 -Enable/Disable global PM.
 -APM interface initialization.
- 53** 1.If it is NOT a PnP BIOS, initialize serial & paralalled ports.
 2.Initialize time value in BIOS data area by translate the RTC time value into a timer tick value.
- 60** Setup Virus Protection. (Boot Sector Protection) functionality according to Setup setting.
- 61** 1.Try to turn on Level 2 cache.
 Note : if L2 cache is already turned on in POST 3D, this part will be skipped.
 2.Set the boot up speed according to Setup setting.
 3.Last chance for Chipset initialization.
 4.Last chance for Power Management initialization. (Green BIOS only)
 5.Show the system configuration table.
- 62** 1.Setup daylight saving according to Setup value.
 2.Program the NUM Lock, typematic rate & typematic speed according to Setup setting.
- 63** 1.If there is any changes in the hardware configuration, update the ESCD information. (PnP BIOS only)
 2.Clear memory that have been used.
 3.Boot system via INT 19H.
- FF** System Booting. This means that the BIOS already pass the control right to the operating system.

Unexpected Errors:

POST(hex) DESCRIPTION

- B0** If interrupt occurs in protected mode.
- B1** Unclaimed NMI occurs.

APPENDIX B: I/O CONNECTORS

CN1 : PS/2 MOUSE CONNECTOR:

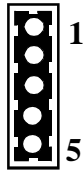

Pin	Signal Name
1	Data (Red Wire)
2	Clock (Blue Wire)
3	GND (Green Wire)
4	NC
5	VCC (Yellow Wire)

CN2/COM1,CN3/COM2 : Serial Ports Connector

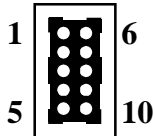

Signal Name	Pin	Pin	Signal Name
DCD	1	6	DSR
SIN	2	7	RTS
SOUT	3	8	CTS
DTR	4	9	RI
GND	5	10	N.C.

CN4 : Parallel Port Connector

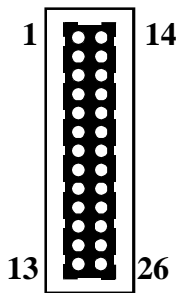

Signal Name	Pin	Pin	Signal Name
STROBE-	1	14	AUTO FEED-
Data Bit 0	2	15	ERROR-
Data Bit 1	3	16	INIT-
Data Bit 2	4	17	SLCT IN-
Data Bit 3	5	18	Ground
Data Bit 4	6	19	Ground
Data Bit 5	7	20	Ground
Data Bit 6	8	21	Ground
Data Bit 7	9	22	Ground
ACJ-	10	23	Ground
BUSY	11	24	Ground
PE	12	25	Ground
SLCT	13	26	N.C.

CN5 : Floppy Disk Connector

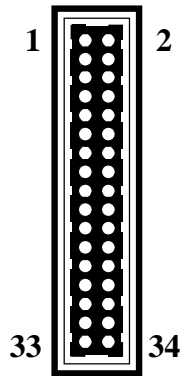

Signal Name	Pin	Pin	Signal Name
Ground	1	2	FDHDIN
Ground	3	4	Reserved
Ground	5	6	FDEDIN
Ground	7	8	Index-
Ground	9	10	Motor Enable
Ground	11	12	Drive Select B-
Ground	13	14	Drive Select A-
Ground	15	16	Motor Enable
Ground	17	18	DIR-
Ground	19	20	STEP-
Ground	21	22	Write Data
Ground	23	24	Write Gate
Ground	25	26	Track 00-
Ground	27	28	Write Protect-
Ground	29	30	Read Data-
Ground	31	32	SIDE 1 SELECT-
Ground	33	34	Diskette

CN6/CN7 : Primary, Secondray IDE Connector

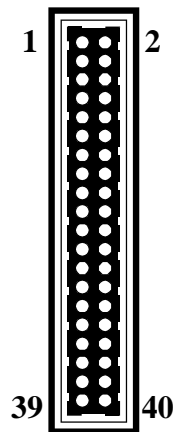

Signal Name	Pin	Pin	Signal Name
Reset IDE	1	2	Ground
Host Data 7	3	4	Host Data 8
Host Data 6	5	6	Host Data 9
Host Data 5	7	8	Host Data 10
Host Data 4	9	10	Host Data 11
Host Data 3	11	12	Host Data 12
Host Data 2	13	14	Host Data 13
Host Data 1	15	16	Host Data 14
Host Data 0	17	18	Host Data 15
Ground	19	20	Key
DRQ3	21	22	Ground
I/O Write-	23	24	Ground
I/O Read-	25	26	Ground
IOCHRDY	27	28	BALE
DACK3-	29	30	Ground
IRQ14	31	32	IOCS16-
Addr 1	33	34	Ground
Addr 0	35	36	Addr 2
Chip Select 0-	37	38	Chip Select 1-
Activity	39	40	Ground

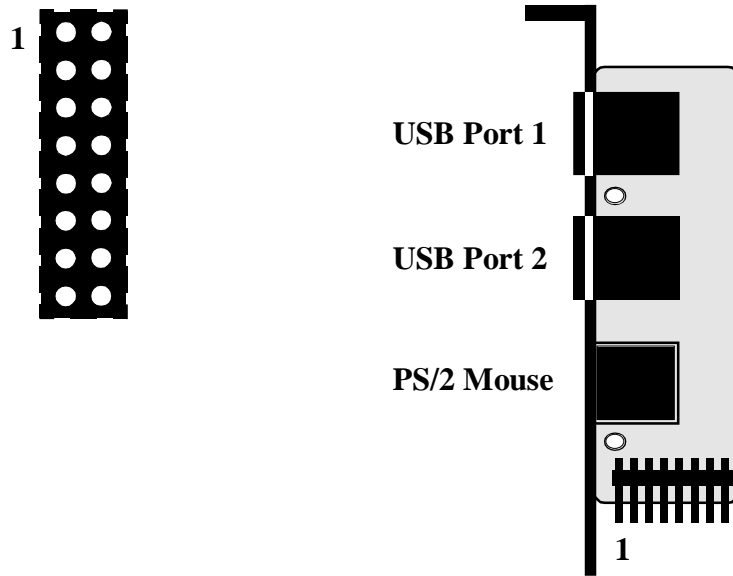
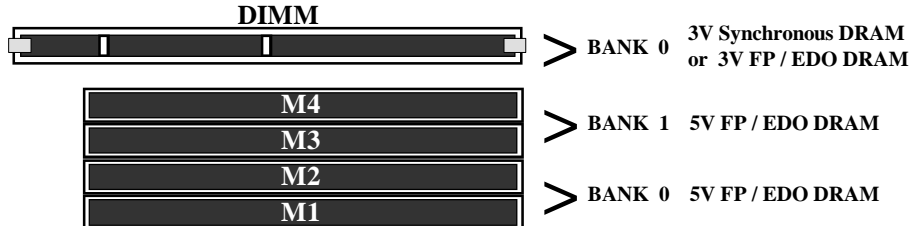

Figure 4-1 USB Port & PS/2 Mouse Adapter

APPENDIX C : Memory Configuration Table



M1,M2(Bank0)	M3,M4(Bank1)	DIMM	Total Size
4M x 2 (8 MB)	Empty	Empty	8MB
4M x 2 (8 MB)	4M x 2 (8 MB)	Empty	16MB
4M x 2 (8 MB)	8M x 2 (16 MB)	Empty	24MB
4M x 2 (8 MB)	16M x 2 (32 MB)	Empty	40MB
4M x 2 (8 MB)	32M x 2 (64 MB)	Empty	72MB
8M x 2 (16 MB)	Empty	Empty	16MB
8M x 2 (16 MB)	4M x 2 (8 MB)	Empty	24MB
8M x 2 (16 MB)	8M x 2 (16 MB)	Empty	32MB
8M x 2 (16 MB)	16M x 2 (32 MB)	Empty	48MB
8M x 2 (16 MB)	32M x 2 (64 MB)	Empty	80MB
16M x 2 (32 MB)	Empty	Empty	32MB
16M x 2 (32 MB)	4M x 2 (8 MB)	Empty	40MB
16M x 2 (32 MB)	8M x 2 (16 MB)	Empty	48MB
16M x 2 (32 MB)	16M x 2 (32 MB)	Empty	64MB
16M x 2 (32 MB)	32M x 2 (64 MB)	Empty	96MB
32M x 2 (64 MB)	Empty	Empty	64MB
32M x 2 (64 MB)	4M x 2 (8 MB)	Empty	72MB
32M x 2 (64 MB)	8M x 2 (16 MB)	Empty	80MB
32M x 2 (64 MB)	16M x 2 (32 MB)	Empty	96MB
32M x 2 (64 MB)	32M x 2 (64 MB)	Empty	128MB

NOTE : 1. P55-TV support both Fast Page DRAM or EDO DRAM SIMMs, but they cannot be mixed within the same memory bank.

M1,M2(Bank0)	M3,M4(Bank1)	DIMM	Total Size
Empty	Empty	8MB	8MB
Empty	4M x 2 (8 MB)	8MB	16MB
Empty	8M x 2 (16 MB)	8MB	24MB
Empty	16M x 2 (32 MB)	8MB	40MB
Empty	32M x 2 (64 MB)	8MB	72MB
Empty	Empty	16MB	16MB
Empty	4M x 2 (8 MB)	16MB	24MB
Empty	8M x 2 (16 MB)	16MB	32MB
Empty	16M x 2 (32 MB)	16MB	48MB
Empty	32M x 2 (64 MB)	16MB	80MB
Empty	Empty	32MB	32MB
Empty	4M x 2 (8 MB)	32MB	40MB
Empty	8M x 2 (16 MB)	32MB	48MB
Empty	16M x 2 (32 MB)	32MB	64MB
Empty	32M x 2 (64 MB)	32MB	96MB
Empty	Empty	64MB	64MB
Empty	4M x 2 (8 MB)	64MB	72MB
Empty	8M x 2 (16 MB)	64MB	80MB
Empty	16M x 2 (32 MB)	64MB	96MB
Empty	32M x 2 (64 MB)	64MB	128MB

Note : 1. Because the DIMM or (M1,M2) occupies the same memory block(BANK 0). So they cannot be installed at the same time.

2. DIMM Module Specification : 3.3V / Unbuffered

