Table of Content

Quick Installation	3
Before Installation.....	3
Layout.....	4
Item Checklist.....	4
Jumpers/ Connectors.....	5
Form Factor.....	10
Feature	11
Motherboard Components Placement.....	11
Block Diagram.....	13
Specifications.....	14
Hardware Setup	16
Install the Processor.....	16
Install Memory Modules.....	19
ATX Power Supply Connector.....	20
Back Panel.....	21

BIOS Setup	22
BIOS Setup.....	22
Main Menu.....	24
Standard CMOS Features.....	24
Advanced BIOS Features	28
Advanced Chipset Features.....	32
Integrated Peripherals.....	34
Power Management Setup.....	39
PnP/ PCI Configurations.....	43
PC Health Status.....	45
IWILL Smart Setting.....	45
Load Fail Safe Defaults.....	47
Load Optimized Defaults.....	47
Set Supervisor/ User Password Setting.....	48
Save & Exit Setup.....	49
Exit Without Saving.....	49
On board Audio	50
Audio Features.....	50
IWILL 6Channel Audio/SuperAudio(Optional).....	52
Driver Installation.....	54
The Audio Rack.....	56
Power Installer CD.....	59
Software Installation.....	59
Making driver diskette.....	60

Quick Installation

Before Installation

For installation, you may need some or all of the following tools:

Medium size flatblade screwdriver

Medium size Phillips head screwdriver

A 3/16 inch nut driver or wrench



Users must follow these guidelines to ensure the motherboard is protected during installation.

1. Make sure your computer is powered-off whenever working with inside components
2. The motherboard, like all other electronic equipment, is sensitive to static. Please take the proper precautions when handling it. If possible, ground yourself by touching a metal table or desk. Keep the board in its protective wrapping until it is configured and ready to be installed in your system.
3. Keep all magnets away from both your hard and floppy disk drives, especially magnetic screw drivers. Keep both floppy and hard disks apart if disassembled.
4. Keep water and liquids away from your computer and its components.

Layout

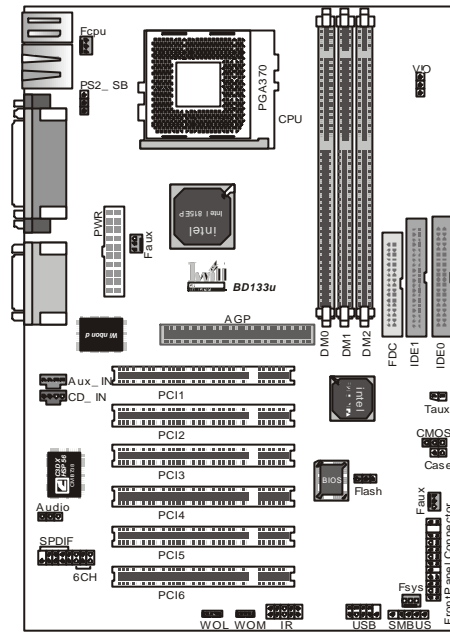

Item Checklist

- [V] The motherboard
- [V] Operation manual
- [V] ATA 100/66 IDE cable
- [V] Floppy cable
- [V] Power Installer CD
- [V] 6 Channel Audio (with cable & Bracket)

Optional

- [] USB riser kit
- [] Thermal Sensor for System
- [] Infrared port cable
- [] Optional Module (SPDIF version only)
- [] IWILL Super Audio (for SPDIF)

Jumpers/Connectors

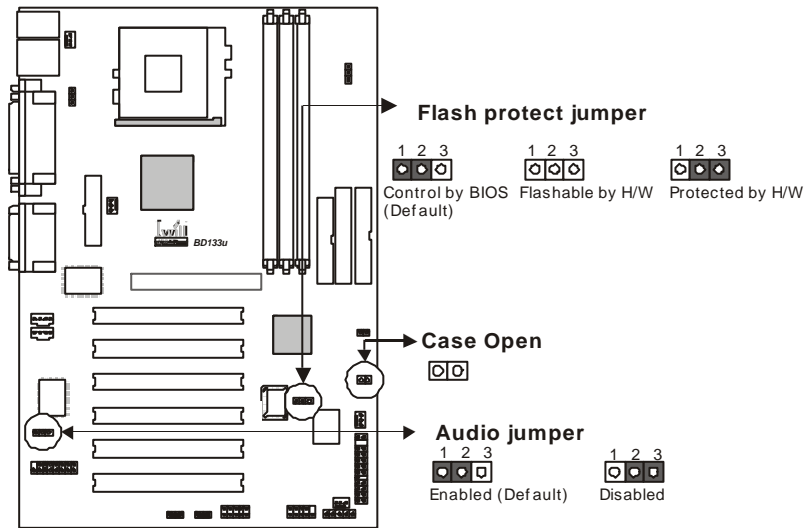
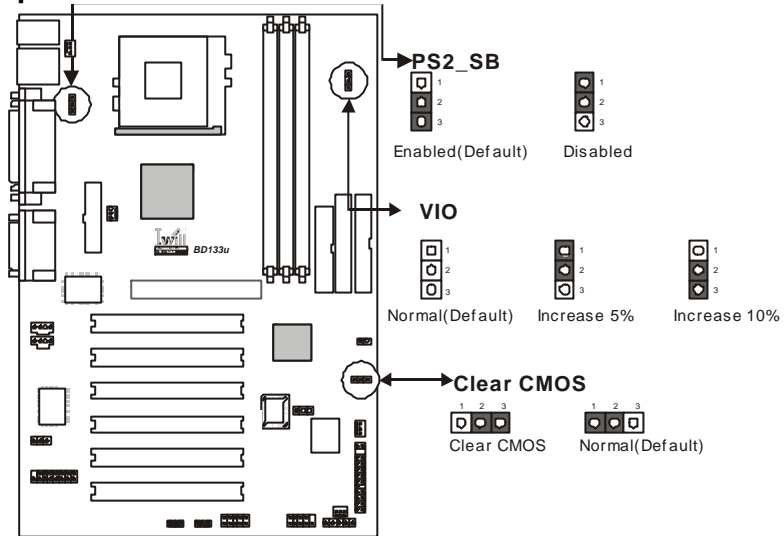

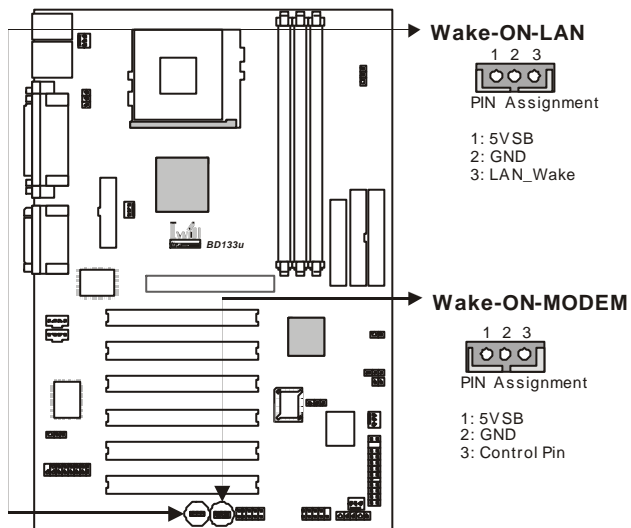
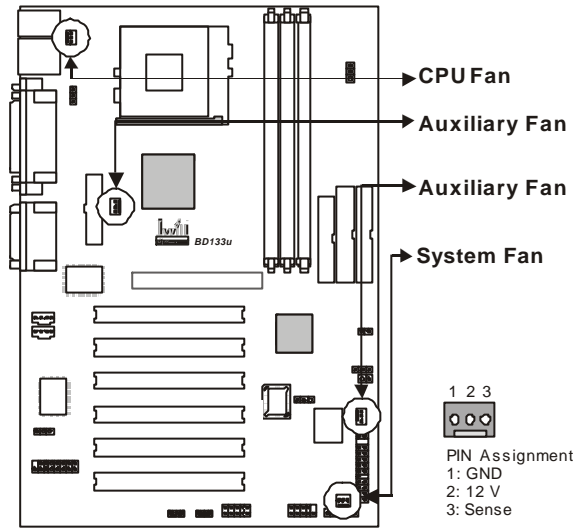

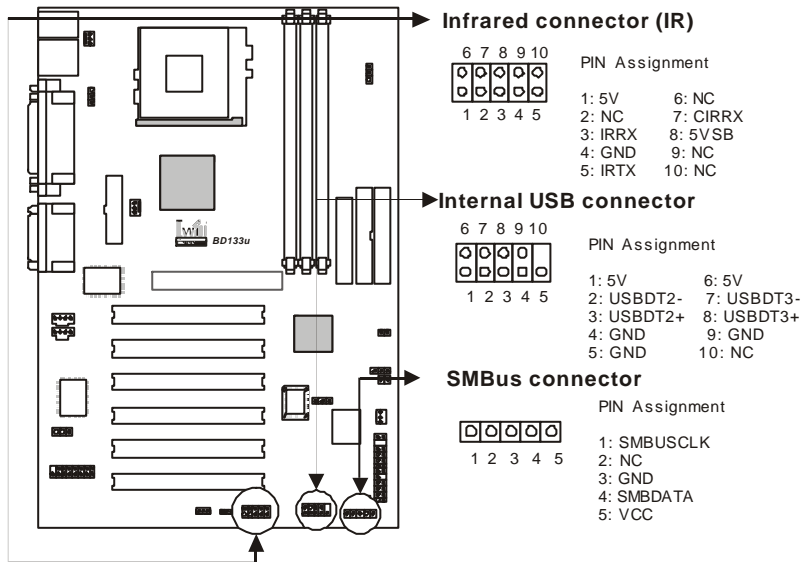
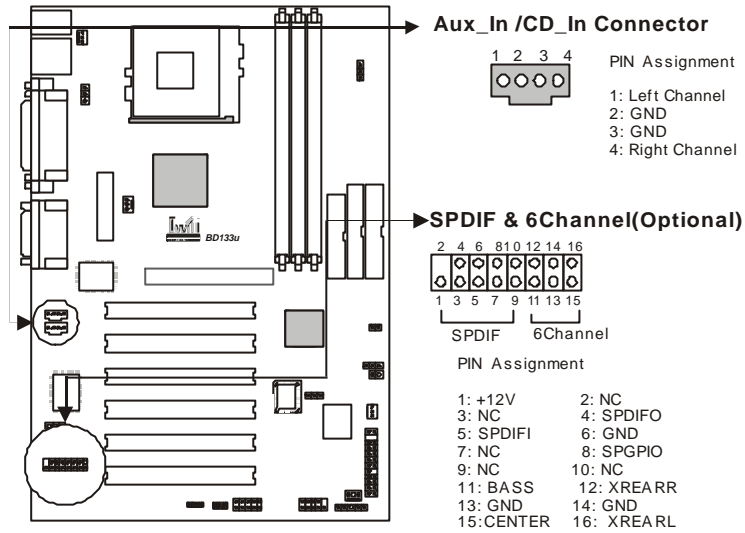

Front panel connector

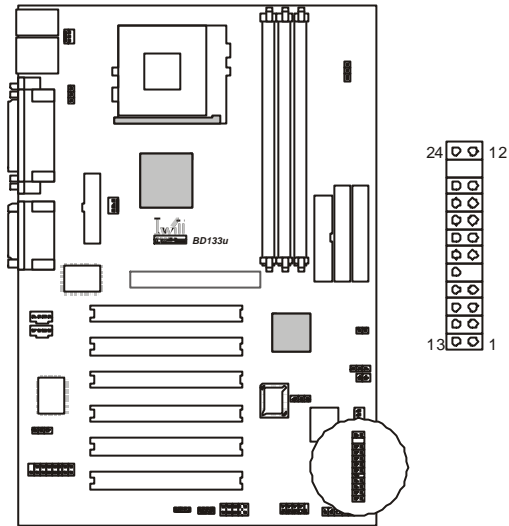

Function	PIN NO.	Definition
PWR_ON (Power/Soft_Off)	12,24	
ACPI(ACPI LED)	21,22	PIN 22:Anode PIN 21:Cathode
A LED(IDE LED)	17,18	PIN 18:Anode PIN 17:Cathode
RST(RESET)	13,14	PIN 14:RST PIN 13:GND
P LED (System PowerLED)	8,9,10	PIN 10:VCC PIN 9:NC PIN 8:GND
KL (Keyboard Lock)	6,7	PIN 7:KL PIN 6:GND
SPKR(Speaker)	1,2,3,4	PIN 4:VCC PIN 3:NC PIN 2:NC PIN 1:SPEAK (BUZZ)

ATX power connector

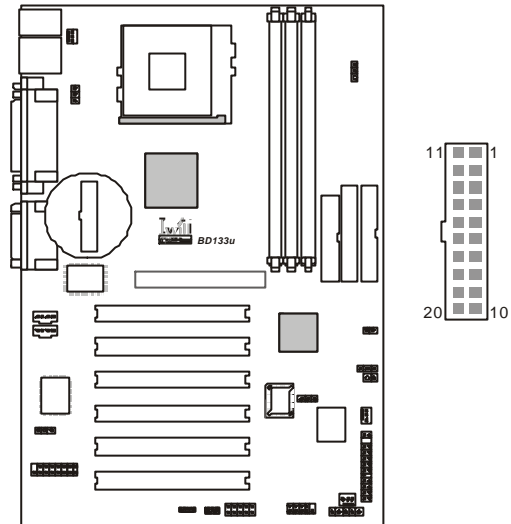

PIN No.	Definition	PIN No	Definition
1	+3.3V	11	+3.3V
2	+3.3V	12	-12V
3	Ground	13	Ground
4	+5V	14	Power Supply On
5	Ground	15	Ground
6	+5V	16	Ground
7	Ground	17	Ground
8	Power Good	18	-5V
9	+5V	19	+5V
10	+12V	20	+5V

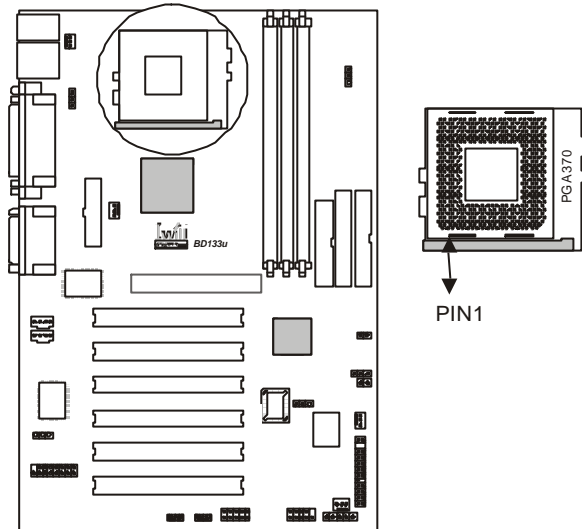

Form Factor

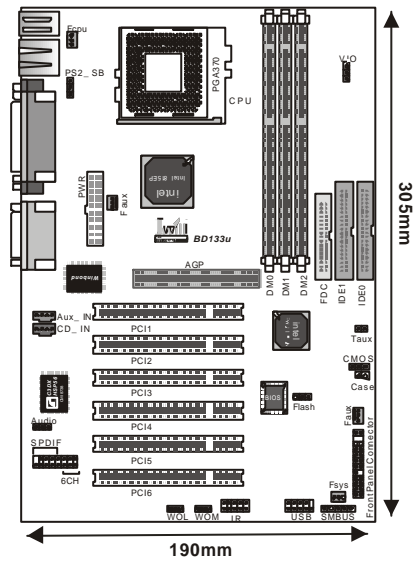

Features

Motherboard Components Placement

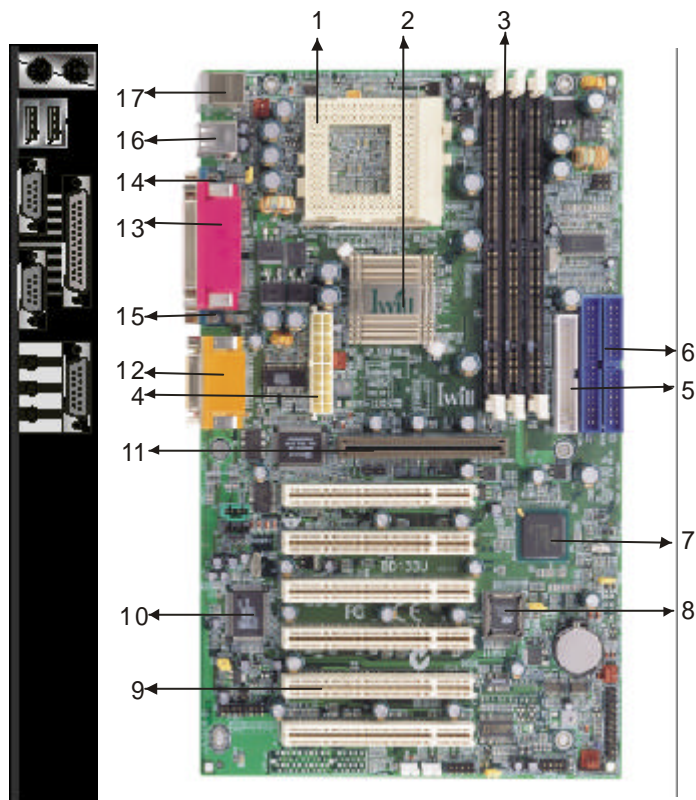

NO.	Description
1	CPU Socket (370 Pin)
2	Intel 815EP chipset (B-step)
3	DIMM sockets
4	ATX Power connector
5	FDC connector
6	IDE connector
7	Intel ICH2 chipset
8	FWH chipset for programmable BIOS
9	PCI slots
10	CMI sound chip
11	AGP slot
12	Joystick, Midi Line In / Out, Microphone In
13	Parallel Port
14	COM1
15	COM2
16	USB
17	PS2 Mouse / Keyboard

Block Diagram

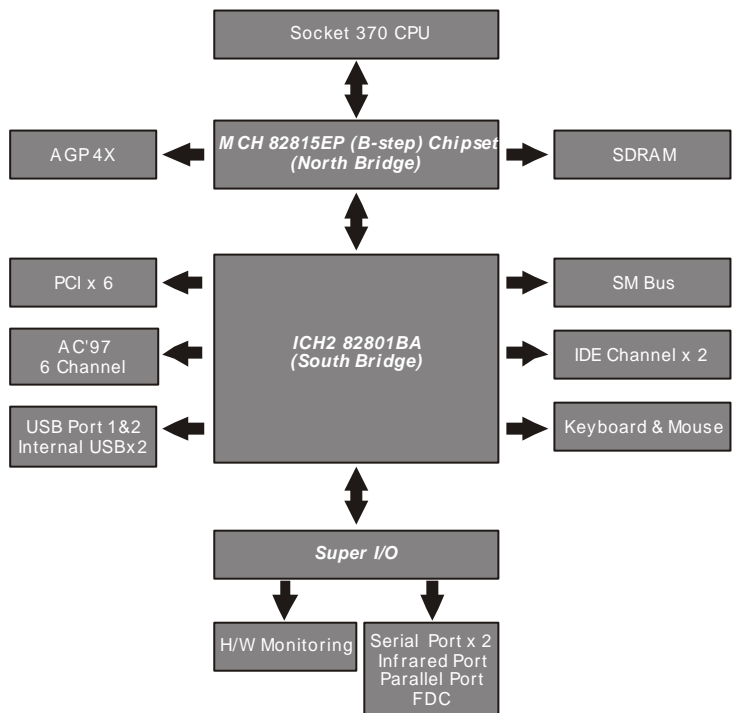

Specifications

Processor / (Socket370)

Supports Socket370 Tualatin processor
Supports 66M/100M/133 MFront Side Bus
Supports Intel Celeron (Cu-128, FCPGA) CPU from 566 MHz to 733 MHz and higher
Supports Intel Pentium III (Cu-256, FCPGA) CPU from 500 MHz to 1GHz and higher

CPU Frequency/Voltage Selection

Supports Vcore selection from BIOS
Supports VIO selection from Jumpers (+5%, +10%)
Supports CPU Multiplier selection from BIOS
Supports CPU External Frequency selection from BIOS

Memory

Supports PC100/PC133 SDRAM/ESDRAM
Supports Unbuffered DIMMs
Supports 16M/64M/128M/256MDRAM
Maximum 512MB Memory Capacity

Graphics

Supports Universal AGP 4X / 2X mode AGP Adaptor

General I/O

PCI 2.2 compliance
Supports 32-bit/33MHz PCI interface
Supports LPC interface
Supports ATA33/ATA66/ATA100 IDE interface
Supports Floppy interface
Supports 16550AUART interface
Supports ECP/EPP interface
Supports PS2 interface
Supports SIR/FIR/CIR interface
Supports 4XUHCI USB interface

Sound support

C-Media 6 Channel HW Sound controller on board
Supports Game/MIDI interface
Supports Win9X/WinNT/Win2000/WinME.

Management

Supports voltage monitoring
(+12V/-12V/+5V/-5V/Vcore/VTT/VIO/Mbat/5VSB)
Supports fan control signal (CPU/AUX/SYS1/SYS2)
Supports temperature sensor (CPU/AUX/SYS)
Supports Chassis Intrusion
Supports Power on by LAN/Ext. Modem/Int. Modem/PS2 Keyboard/
PS2 Mouse/RTC/PME
Supports Resume by LAN/Ext. Modem/Int. Modem/PS2 Keyboard/
PS2 Mouse/RTC/PME
Supports Intel LDCM
Supports ACPI
Supports APM
Supports DMI
Supports SMBUS
Supports PnP
Supports BIOS ROM Flash Control
(3-pin jumper provide H/W & S/W protection)
Supports "AC-Loss Recovery"
Supports Manually Assign PCI IRQ
Supports PS2 mouse and PS2 keyboard auto swapping

Power requirement

Onboard DC/DC switching voltage regulator supports VIO up to 10A
current
Supports adjustable VO (Normal/Increase 5%/Increase 10%,
Normal=3.4V, jumper)
Supports 20A/us Icc slew rate
Supports 8A/us VTT slew rate

Board Size

ATX Form Factor 305mm x 190mm

Hardware Setup

Install the Processor



The CPU should have a fan attached to it to prevent overheating. If this is not the case, then purchase a fan before you turn on your system.

Be sure that there is sufficient air circulation across the processor's heatsink by regularly checking that your CPU fan is working. Without sufficient circulation, the processor could overheat and damage both the processor and the motherboard. You may install an auxiliary fan, if necessary.

Step1:

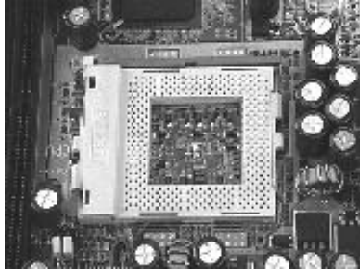

Locate the ZIF socket and open it by first pulling the lever of socket upward.

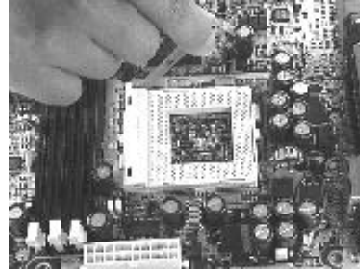

Step2:

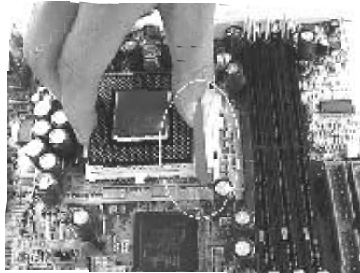

Insert the CPU into the socket. Please keep the lever right angle when inserting CPU.

Step3:

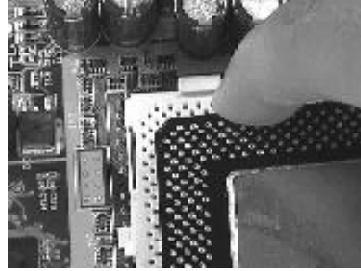
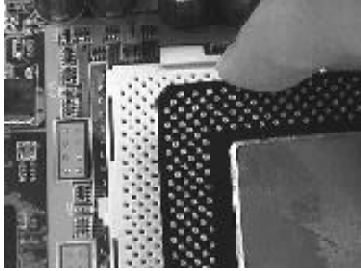

When inserting the CPU Please note the correct orientation as shown. The notched corner should point toward the end of the lever.

Step4:

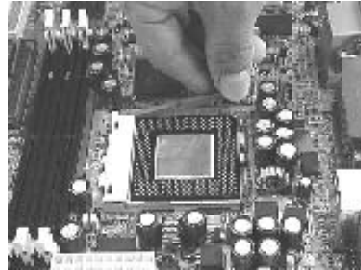
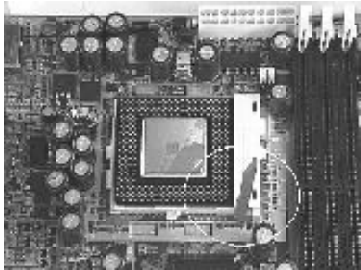

Push the lever down to close the socket.

Step5:

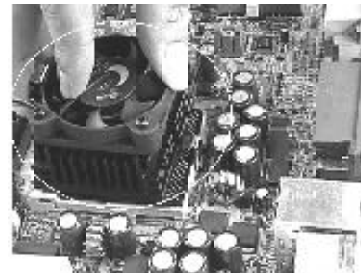
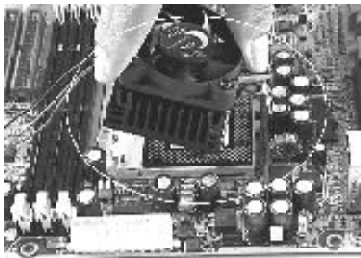

Attach the heatsink to the CPU.



Be careful not to scrape the motherboard when mounting a clampstyle processor fan or else damage may occur to the motherboard.

Step6:

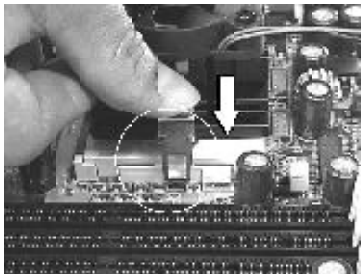

Push the clip of heatsink downward to hook the ear of socket firmly.

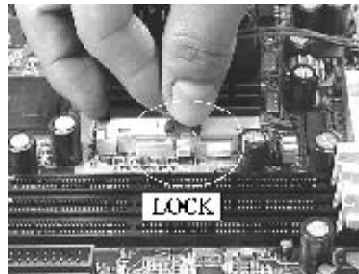

Step7:

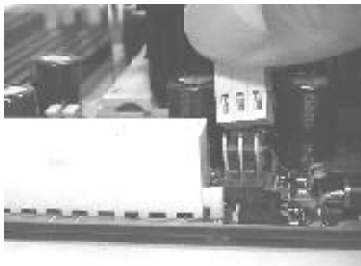

Finally, attach the fan cable to the CPU fan header FCPU.

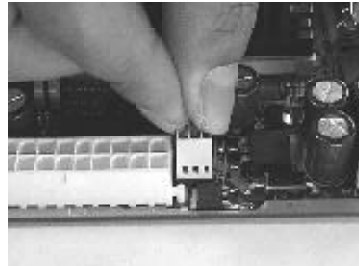

Don't forget to set the correct Bus Frequency and Multiple (frequency multiple setting is available only on unlocked processors) for your Socket 370 processor or else boot-up may not be possible.

Install Memory Modules

The motherboard has three Memory sockets and supports memory size up to 3GB.



The chipset does not support ECC. However, the ECC memory modules may still be used, but the ECC function will not be available. No hardware or BIOS setup is required after adding or removing memory modules.

Step1:

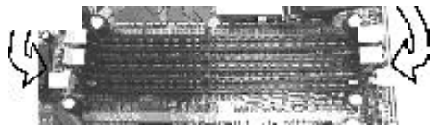

Open latches of DIMM socket.

Step2:

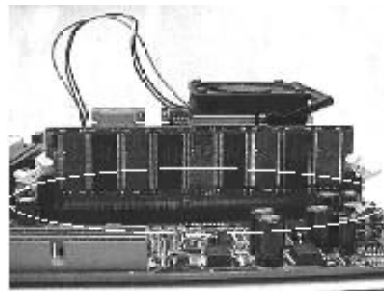

Proofread the RAM module to the DIMM Socket.

Step3:

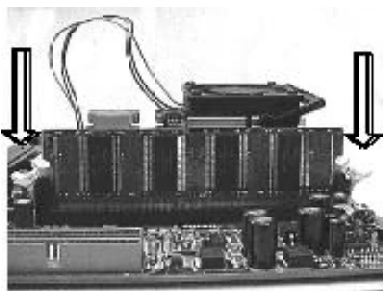

Insert the RAM module into the DIMM socket.

Step4:

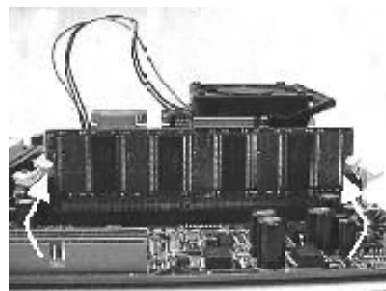

Press the latches into the notches of the RAM module.

ATX Power Supply Connector

Power on procedures

STEP	Description
1	After all connections are made, close the system case over.
2	Be sure that all switches are off.
3	Connect the power cord into the power supply located on the back of your system case.
4	Connect the power cord a power outlet that is equipped with a surge protector.
5	Many of the power supply support 110V/220V by a switch setting. Switch your power supply to the correct supply voltage.
6	Turn on your system in the following order a. The monitor b. The external devices. c. The computer system.



The power LED on the front panel of the chassis will light. After few seconds, the system will then run power-on tests. Some additional messages will appear on the screen during the test. If you do not see anything within 30 seconds from the time you turn on the power, the system may have failed a power-on test. Recheck the jumper settings and connections or call your retailer for assistance.

Back Panel

Function	color	Description
PS2/Mouse	Green	This connector can be used to support a PS/2 mouse
PS2/ keyboard	Purple	This connector can be used to support a PS/2 keyboard.
Universal Serial Bus	Black	This motherboard has two USB ports, any USB-compatible peripherals and/or hub can be connected into either USB port.
Serial port	Teal	One serial port is ready for a modem or other serial devices
Parallel port	Burgundy	This connector is used for printers, or other parallel devices.
Joystick, Midi and Audio Port	Gold	You may connect joysticks or game pads to this connector for playing games, or connect MIDI devices for playing / editing professional audio. Line Out (Lime color) can be connected to headphones or powered speakers. Line In (Light Blue color) allows audio sources to be recorded by your computer or played through the Line Out connector. Mic (Pink color) allows microphones to be connected for inputting voice.

BIOS Setup

BIOS Setup

Upgrade BIOS

The BIOS can be upgraded from a diskette with the Award Flash utility — AWDFLASH.EXE. The BIOS image file, and update utility are available from IWILL's WEB site: support.iwill.net

Enter BIOS setup program

Power-on the system by either pressing the Power-On button, or by using any of the power-on features provided by the motherboard. Then, press the key after the Power-On Self Test (POST), and before the scanning of IDE devices. Simply look for the message "Press DEL to enter SETUP" displayed at the bottom of the screen during the boot up process. If the message disappears before you've had a chance to respond, you can restart the system by turning off the system power then turn it on again, or Pressing the "RESET" button on the system case, or

Pressing <Ctrl>, <Alt> and keys simultaneously.



Generally, the BIOS default settings have been carefully chosen by IWILL's Engineers provide the absolute maximum performance and reliability. It is very dangerous to change any setting without full understanding. We strongly recommend that you. DO NOT update BIOS if the system works perfectly. DO NOT change any setting unless you fully understand what it means.

Using BIOS setup program

↑Up	Move to the previous field
↓Down	Move to the next field
←Left	Move to the field on the left hand side
→Right	Move to the field on the right hand side
<Esc>	Quit from setup program without saving changes, or Exit from current menu page and return to main menu page
<PgUp> or <+>	Select the previous value for a field
<PgDn> or <->	Select the next value for a field
<F1>	General Help
<F2>	Item Help
<F5>	Previous Values
<F6>	Fail-Safe Defaults
<F7>	Optimized Defaults
<F10>	Save the current value and exit setup program

If the system is no longer able to boot after changing the settings, the only way to recover it is to clear the data stored in RTC CMOS. To reset the RTC CMOS data, take the JP1 jumper cap off pins 1-2, place onto pins 2-3, and then place back onto pins 1-2 again. This will return the RTC to the default setting. Then, get into the BIOS setup program, choose Load Fail-Safe Defaults; Load Optimized Defaults, and select the original manufacturer default settings in your CMOS.

Main Menu

The main menu allows you to select from several setup pages. Use the arrow keys to select among these pages and press <Enter> key to enter the sub-menu. A brief description of each highlighted selection appears at the bottom of the screen.

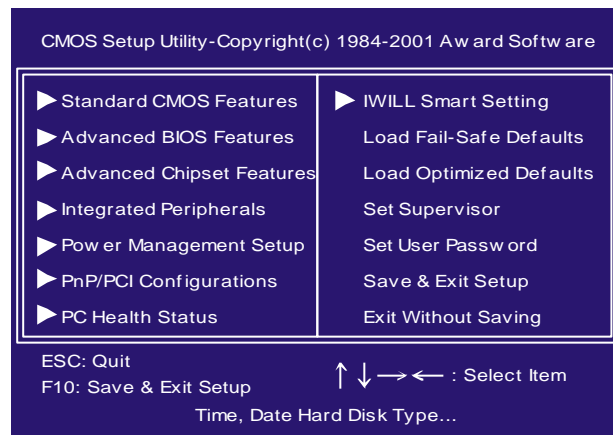

Standard CMOS features

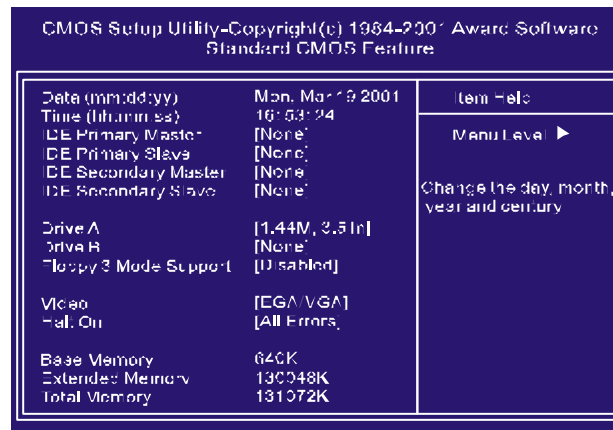

Date

This field specifies the current date. The date format is <month>, <day>, and <year>.

Time

This field specifies the current time. The time format is <hour>, <minute>, and <second>. The time is calculated based on the 24-hour (military-time) clock.

IDE Primary Master / Primary Slave / Secondary Master / Secondary Slave

Press "Enter" to enter next page for detail hard drive setting.

IDE HDD Auto-Detection

Auto-Detect the HDDs Capacity, and its parameters, ex Cylinder, Head and Sector.

IDE Primary Master / Primary Slave / Secondary Master / Secondary Slave

This field specifies type of drive that corresponds to the drive installed in your system. If you select User, please specify the correct number of Cylinders, Heads, and Sectors.

Manual	Selecting manual lets you set the remaining fields on this screen. Selects the type of fixed disk.
Auto (Default Value)	BIOS automatically fills in the values for the cylinders, heads and sectors fields.
None	Any Disk Drives are attached

Capacity Auto Display your disk drive size

Access MODE

This field specifies the IDE translation mode.

NORMAL	Specifies traditional CHS addressing mode.
LARGE	Specifies extended CHS translation mode
LBA	Specifies LBA translation mode.
AUTO (Default Value)	BIOS specifies translation method automatically.

Cylinders

Set the number of cylinders for this hard disk.

Heads

Set the number of read/write heads

Precomp

Setting a value of 65535 means no hard disk

Sectors

Set the number of sectors per track

Drive A / Drive B

This field specifies the traditional type of floppy drives.

None (*Drive B default)	Any Floppy drive is connected
360K, 5.25 in.	Specifies extended CHS translation mode
1.2M, 5.25 in.	A 1.2M floppy drive is connected
720K, 3.5 in.	A 720K floppy drive is connected.
1.44M, 3.5 in. (*Drive A default)	A 1.44M floppy drive is connected
2.88M, 3.5 in.	A 2.88M floppy drive is connected

Floppy 3 Mode Support

3 Mode floppy drive is a type of 3.5-inch drive used by NEC PC98 computers. It supports both 1.2M and 1.44M formats using the same drive. This field specifies which drive supports 3 Mode.

When a floppy drive is specified to support 3 Mode, the respective drive setting in "Drive A / Drive B" field will be invalid.

Disabled (Default Value)	No 3 Mode drive is connected
Drive A	A 3 Mode drive is connected as drive A
Drive B	A 3 Mode drive is connected as drive B
Both	Both drive A and drive B are 3 Mode drives

Video

EGA/VGA (Default Value)	Specifies EGA or VGA adapter
CGA 40	Specifies CGA adapter with 40 column mode
CGA 80	Specifies CGA adapter with 80 column mode
MONO	Specifies Monochrome adapter

Halt On

All Errors (Default Value)	Each time the BIOS detects a non-fatal error, the system will stop and display an error message
No Errors	The system will stop for any errors that are detected
All, But Keyboard	The system will stop for any errors except keyboard error
All, But Diskette	The system will stop for any errors except diskette error
All, But Disk/Key	The system will stop for any errors except diskette and key board errors

Base Memory

The POST (Power-On Self Test) determines the amount of base (conventional) memory installed in the system. The value of the base memory is typically 640K. This field has no options.

Extended Memory

The BIOS determines how much extended memory is present during the POST. This is the amount of memory located above 1MB in the processor's memory address map. This field has no options.

Total Memory

Displays the total memory available in the system

Advanced BIOS Features

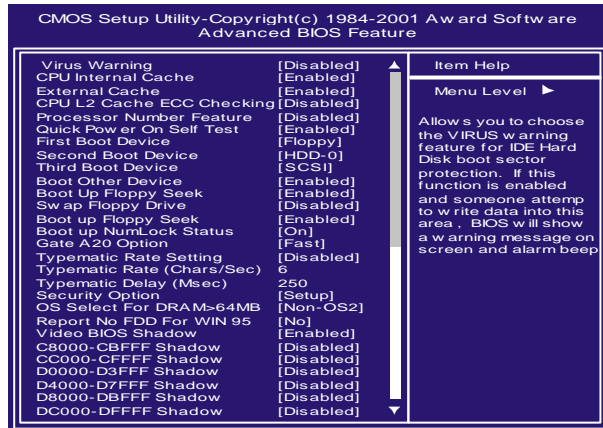

Virus Warning

When this function is enabled and any attempt to write data into this area is made, the BIOS monitor will display a warning message on screen and beep. If you want to run an anti-virus program, we recommend you that it will disable and appear the Virus Warning function beforehand.

[Enable, Disabled(**Default Value**)]

CPU Internal Cache

This field configures the CPU internal cache (L1 cache).

[Enable(**Default Value**), Disabled]

External Cache

This field configures the system's external cache (L2 cache)

[Enable (**Default Value**), Disabled].

CPU L2 Cache ECC Checking

This field specifies whether the CPU L2 cache supports ECC or not.

[Enable, Disabled(**Default Value**)]

Processor Number Feature

Intel® Pentium® III processors are equipped with a built-in processor serial number for security purposes. When enabled, you allow reading access to this serial number.

[Enable, Disabled(**Default Value**)]

Quick Power On Self Test

This field allows the system to skip certain tests while booting. This will decrease the time needed to boot the system.

[Enable(**Default Value**), Disabled]

First / Secondary / Third / Boot Other Device

The BIOS attempts to load the operating system from the devices in the sequence selected in these items.

[Floppy, LS/ZIP, HDD-0, SCSI, CDROM, HDD-1, HDD-2, HDD-3, LAN, Disabled]

Boot Up Floppy Seek

Seeks disk drives during boot up. Disabling speeds boot up.

[Enable(**Default Value**), Disabled]

Swap Floppy Drive

When enabled, floppy drives A and B will be exchanged without the user physically changing the connection on the cable.

[Enable, Disabled(**Default Value**)]

Boot Up NumLock Status

This field determines the configuration of the numeric keypad after system boot up. If On, the keypad uses numbers keys. If Off, the keypad uses arrow keys.

[ON(**Default Value**), Off]

Gate A20 Option

This field configures how the gate A20 is handled. The gate A20 is a device used to address memory above 1 MB. At first, the gate A20 was handled from a pin on the keyboard. While some keyboards still provide this support, it is more common, and much faster, for modern system chipsets to provide support for gate A20.

[Fast(**Default Value**):GateA20 signal supported by core logic]

[Normal: GateA20 signal supported by keyboard controller].

Typematic Rate Setting

This field determines if the typematic rate is to be used. When enabled, the BIOS will report (after a moment) that the key has been depressed repeatedly. When disabled, the BIOS will report only once if a key is held down continuously. This feature is used to accelerate cursor movements using the arrow keys.

[Enable, Disabled(**Default Value**)]

Typematic Rate (Chars/Sec)

When Typematic Rate Setting enabled, this field specifies how many characters will be displayed in one second when a key is held down continuously.

[6(**Default Value**)8,10,12,15,20,24,30]

Typematic Delay (Msec)

When enabled, typematic delay allows you to select the time delay between when the key is first pressed and when the acceleration begins.

[250msec(**Default Value**)500msec,750msec,1000msec]

Security Option

This field configures how the system security is handled. It works in conjunction with SETTING SUPERVISOR / USER PASSWORD page to control the security level of the system.

[Setup(**Default Value**):System needs a password to enter BIOS setup program.]

[System:System needs a password to boot.]

OS Select for DRAM >64MB

When enabled, this field allows you to access the memory that is over 64MB under OS/2.

[OS2, Non-OS2(**Default Value**)]

Report No FDD For WIN 95

For a floppydiskless system that runs Windows 95, this field should be set to Yes.

[YES, NO(**Default Value**)]

Video BIOS Shadow

Setting to enabled, the video BIOS will be copied to the system memory and increase video speed accordingly.

[Enable(**Default Value**), Disabled]

C8000-CBFFF / CC000-CFFFF / D0000-D3FFF / D4000-D7FFF / D8000-DBFFF / DC000-DFFFF Shadow

Setting to enabled, the extended ROM data located at the respective address range will be copied to system memory.

[Enable, Disabled (**Default Value**)]

Advanced Chipset Features

This setup page is used to specify advanced features available through the chipset. The default settings have been chosen carefully for most operating conditions. DONOT change the value of any field in this setup page without full understanding.

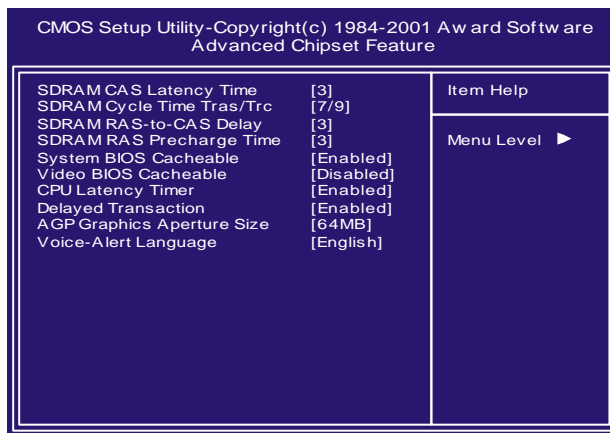

DRAM Settings

The first chipset settings deal with CPU access to dynamic random access memory (DRAM). The default timings have been carefully chosen and should only be altered if data is being lost. Such a scenario might well occur if your system had mixed speed DRAM chips installed. Longer delays might result, however this preserves the integrity of the data held in the slower memory chips.

SDRAM CAS Latency Time

This controls the number of clocks between the SDRAM read command and the time that the data actually becomes available.

[2.3(Default Value)]

SDRAM Cycle Time Tras/Trc

This controls the number of SDRAM clocks used per access cycle.

[5/7,7/9(Default Value)]

SDRAM RAS-to-CAS Delay

This controls the number of clocks between the SDRAM active command and the read / write command.

[2,3(Default Value)]

SDRAM RAS Precharge Time

If an insufficient number of cycles is allowed for the RAS to accumulate its charge before DRAM refresh, the refresh may be incomplete and the DRAM may fail to retain data. This controls the idle(delay) clocks after issuing a precharge command to the SDRAM.

[2,3(Default Value)]

System BIOS Cacheable

When enabled, accesses to the system BIOS will be cached.

[Enable(Default Value),Disabled]

Video BIOS Cacheable

When enabled, access to the video BIOS will be cached.

[Enable, Disabled(Default Value)]

CPU Latency Timer

[Enable(Default Value),Disable]

Delayed Transaction

When enabled, the south bridge ICH2 will support the Delayed Transaction mechanism when it is the target of a PCI transaction.

[Enable(Default Value),Disabled]

AGP Graphics Aperture Size

This field configures the main memory size for AGP graphics data used.

[32MB,64MB(Default Value)]

Voice-Alert Language

It's a convenient diagnostics system function.

“***WILL Voice Alert***” technology helps users understand the system status.

Select “English ” or “Chinese ” for alert language.

[English(Default Value),Chinese]

Integrated Peripherals

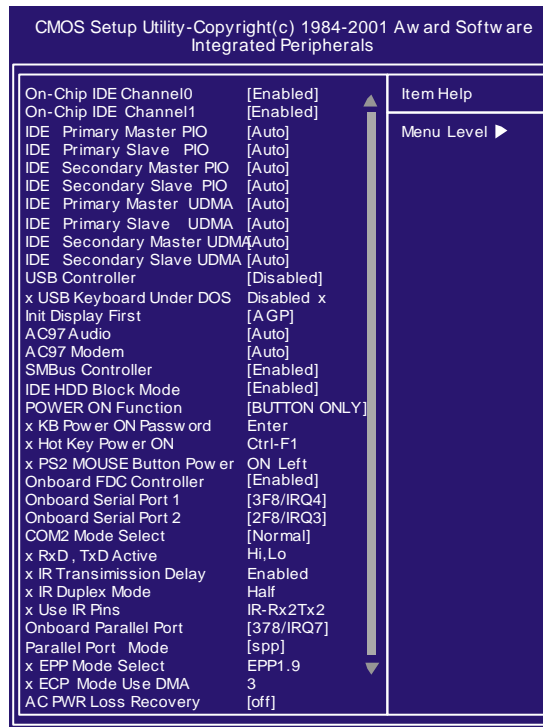

On-Chip primary/Secondary PCI IDE

This field enables or disables the onboard IDE controller.
[Enable(**Default Value**), Disabled]

IDE Primary Master / Slave PIO

IDE Secondary Master / Slave PIO

These fields configure the PIO (Program mable Input Output) transfer mode for each IDE devices. The maximum transfer rates of each PIO mode are listing as follow:

PIO Mode 0	3.3 MB/sec
PIO Mode 1	5.2 MB/sec
PIO Mode 2	8.3 MB/sec
PIO Mode 3	11 MB/sec
PIO Mode 4	16.6 MB/sec

Auto(Default Value)	Negotiated with device automatically
Mode 0	Use Mode 0 timing to access device
Mode 1	Use Mode 1 timing to access device
Mode 2	Use Mode 2 timing to access device
Mode 3	Use Mode 3 timing to access device
Mode 4	Use Mode 4 timing to access device

IDE Primary Master / Slave UDMA**IDE Secondary Master / Slave UDMA**

If you select Auto, the IDE controller uses Ultra DMA33/66 Mode to access UltraDMA-capable IDE devices. Depend on the result of negotiation with your HDD. The maximum transfer rate of Ultra DMA66 Mode is 66.6 MB/sec.

[Auto(**Default Value**),Disabled]

USB Controller

Select Enabled if your system contains USB peripherals.

[Enable, Disabled(**Default Value**)]

USB Keyboard under DOS

Select Enabled if you want to use USB keyboard under DOS

[Enable, Disabled(**Default Value**)]

Init Display First

This item allows you to decide which slot to activate first, either PCI slot or AGP slot.

[PCI Slot,AGP(**Default Value**)]

AC97 Audio/Modem

Auto" allows the motherboard's BIOS to detect whether you are using any AC'97 modem/audio device. If a modem/audio device is detected, the onboard modem/audio controller will be enabled; if no modem/audio device is detected, the onboard modem/audio controller will be disabled. If you want to use different controller cards to connect modem and audio connector, set these fields to disabled".

[Disabled, Auto(**Default Value**)]

SMBus Controller

[Enable(**Default Value**),Disable]

IDE HDD Block Mode

When enabled, the IDE controller will use the faster block mode to access devices.

[Enable, Disabled(**Default Value**)]

Power-On Function

This field configures the Power-On mode of the system.
The Power-On button will not function in this mode.

Passw ord	You can assign a passw ord string through KB Pow er-On Pass w ord field.
Hot KEY	You can assign a hot key through the Hot Key Pow er-On field. Pressing this hot key will pow er-on your system.
Mouse/ Passw ord	Double-Clicking the mouse button or typing the KB pow er-on passw ord will automatically pow er-on your system.
Mouse/Hot KEY	Double-Clicking the mouse button or typing the KB hot-key will pow er-on your system.
Button only (Default Value)	Simply pow er-on your system by pressing the Pow er-On button on the front panel of your PC case.
Keyboard 98	Enables Keyboard 98 function. This function is good only for users of Keyboard 98.

KB Power ON Password

If you wish to use this function, bring the cursor to the field written Enter, then press <Enter>. The computer will display the message, Enter Password". Type your password and press <Enter>. After the message Confirm Password is displayed, re-type your password. The KB Power-On function will be in effect after you save and exit setup.

To disable a password, bring the cursor to the Enter" field again, then press <Enter>. The computer will display the message, Enter Password Press <Enter>. A message will confirm that the password is disabled.

Hot Key Power-On

This field specifies key selection for the Keyboard-Power On hot key.

[Ctrl-F1, Ctrl-F2, Ctrl-F3, Ctrl-F4, Ctrl-F5, Ctrl-F6, Ctrl-F7, Ctrl-F8, Ctrl-F9, Ctrl-F10, Ctrl-F11, Ctrl-F12]

PS2 MOUSE Button Power on

The field specifies key selection for PS2 MOUSE Button Power on.
[Left,Right]

Onboard FDC Controller

This field enables or disables the onboard floppy controller.
[Enable(**Default Value**),Disabled]

Onboard Serial Port 1 / 2

These fields configure the onboard serial ports. There are several port addresses and IRQ channels to select from.

3F8 / IRQ 4 (Default Vaule)	Port address 3F8h, IRQ 4
2F8 / IRQ 3 (Default Vaule)	Port address 2F8h, IRQ 3
3E8 / IRQ 4	Port address 3E8h, IRQ 4
2E8 / IRQ 3	Port address 2E8h, IRQ 3
Auto	BIOS assigns port address and IRQ channel automatically.
Disabled.	Disables serial port

COM2 Mode Select

This field must be configured in order to use the infrared connect which supports infrared wireless transmitting and receiving of data between devices when using the appropriate application software.

RxD, TxD Active for IrDA and ASKIR functions

When setting the field to either IrDA or ASKIR, you must select the active level of receiving and transmission signal.
[Hi,Lo(**Default Value**)/Lo,Hi/Lo,Lo/Hi,Hi]

IR Transmission delay for IrDA and ASKIR functions

When setting the field to either IrDA or ASKIR, you must select whether or not you require a delay between IR transmissions.
[Enable(**Default Value**),Disabled]

IR Duplex Mode

[Full,Half(Default Value)]

Use IR Pins

[RxD2,TxD2,IR-Rx2Tx2(Default Value)]

Onboard Parallel Port

This field configures the onboard parallel port. There are several port addresses and IRQ channels to select from.

378 / IRQ 7 (Default Value)	Port address 378h, IRQ 7
278 / IRQ 5	Port address 278h, IRQ 5
3BC / IRQ 7	Port address 3BCh, IRQ 7
Disabled	Disables parallel port

Parallel Port Mode

This field configures the operating mode of an onboard parallel port. Ensure you know the specifications of your parallel port devices before selecting field.

[SPP(Default Value),EPP,ECP ECP+EPP]

EPP Mode Select

When the Parallel Port Mode field is configured as EPP, ECP+EPP mode, the EPP version needs to be specified. Please refer to your peripheral document before selecting field.

[EPP1.7:Use EPP 1.7 protocol]

[EPP1.9 (Default Value):Use EPP 1.9protocol]

ECP Mode Use DMA

When the Parallel Port Mode field is configured as ECP, ECP+EPP mode, it needs a DMAchannel for data transfer. This field specifies theDMAchannel for ECP parallel port use.

[1:Use DMA channel 1]

[3(Default Value):Use DMAchannel1]

AC PWR Loss Recovery

The field configures the system activity after experiencing a power failure.

[Former-Sts: System returns to former status prior to AC loss events]

[Off(**Default Value**): System remains off after AC loss event.])

Power Management Setup

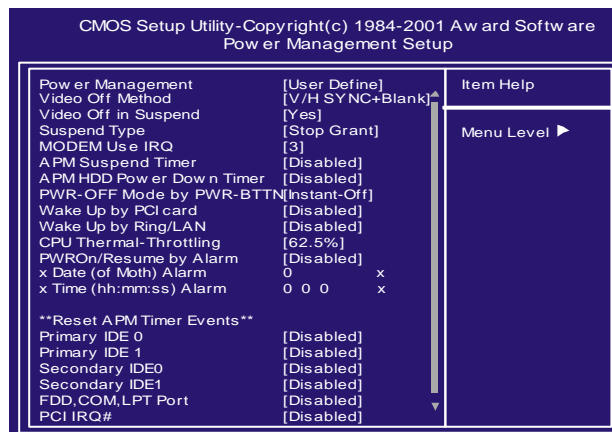

Each power-saving mode has a respective timer. The value of the timer can be assigned or reloaded and it will count down to zero. When the timer equals to zero, the system will be forced into the related suspend or power-saving mode. If any predefined signal or event is detected during the timer counting period, the timer restarts automatically.

Power Management

This feature allows the user to select the default parameters for the power-saving mode.

Min saving	When idle for one hour, the system enters suspend mode.
Max Saving	When idle for fifteen minutes, the system enters suspend mode.
User Define (Default Vaule)	User can specify the time the system enters suspend mode.

Video off Method

V/H SYNC+Blank (Default Vaule)	Turn off the vertical and horizontal synchronization ports and write blanks to the video buffer.
Blank Screen	Writes blanks to the video buffer only.
DPMS	Initial display power management signaling with DPMS.

Video Off In Suspend

This determines the manner in which the monitor is blanked.

[NO, Yes **(Default Value)**]

Suspend Type

Select the Suspend Type.

[PwrON Suspend, Stop Grant **(Default Value)**]

MODEM Use IRQ

This determines the IRQ in which the MODEM can use.

[3 **(Default Value)**, 4, 5, 7, 9, 10, 11, NA]

APM Suspend Timer

This field specifies the time the system enters power-saving mode. It is available only when the Power Management field is set to User Define.

[1Min, 2Min, 4Min, 8Min, 12Min, 20Min, 30Min, 40Min, 1Hour, Disabled **(Default Value)**]

APM HDD Power Down Timer

This field specifies the time the system enters HDD power down. It is available only when the Power Management field is set to User Define.

[1Min, 2Min, 3Min, 4Min, 5Min, 6Min, 7Min, 8Min, 9Min, 10Min, 11Min, 12Min, 13Min, 14Min, 15Min, Disabled(**Default Value**)]

PWR-Off Mode by PWR-BTTN

This field specifies the function of power button.

Instant-Off (Default Vaule)	When power button pressed, the system turns off immediately
Delay 4 Sec.	After the power button has been pressed and held for four seconds, the system turns off

Wake up by PCI card

[Enabled, Disabled(**Default Value**)]

Wake up by RING/LAN

When Wake up by LAN function is enabled, the PC can power-on or "wake up" through LAN (Local Area Network). When Wake up by RING function is enabled, the PC can power-on through an external modem connected to your PC.

[Enabled, Disabled(**Default Value**)]

CPU Thermal throttling

87.5%	Keep 87.5% of CPUs full speed performance
75.0%	Keep 75.0% of CPUs full speed performance
62.5% (Default Vaule)	Keep 62.5% of CPUs full speed performance
50.0%	Keep 50.0% of CPUs full speed performance
37.5%	Keep 37.5% of CPUs full speed performance
25.0%	Keep 25.0% of CPUs full speed performance
12.5%	Keep 12.5% of CPUs full speed performance

PowerOn/Resume by Alarm

When enabled, you can set the date and time to automatically power-on your PC (similar to an alarm clock).

Enabled	Sets Date (0-31) and Timer (hr, min, sec) to power-on the PC. When date is set to 0, the Timer is set for every day.
Disabled (Default Vaule)	Disables RTC alarm function

Reset APM Timer Events

This field enables the system to detect activity, and restart the timer of the power-saving mode.

Primary IDE 0

If enabled, timer restarts whenever the master disk of the primary IDE channel is active.

[Enabled, Disabled (**Default Value**)]

Primary IDE 1

If enabled, timer restarts whenever the slave disk of the primary IDE channel is active.

[Enabled, Disabled (**Default Value**)]

Secondary IDE 0

If enabled, timer restarts whenever the master disk of the secondary IDE channel is active.

[Enabled, Disabled (**Default Value**)]

Secondary IDE 1

If enabled, timer restarts whenever the slave disk of the secondary IDE channel is active.

[Enabled, Disabled (**Default Value**)]

FDD, COM, LPT PORT/

[Disabled (**Default value**), Enabled]

PCI IRQ#

[Disabled (**Default value**), Enabled]

PnP/ PCI Configurations

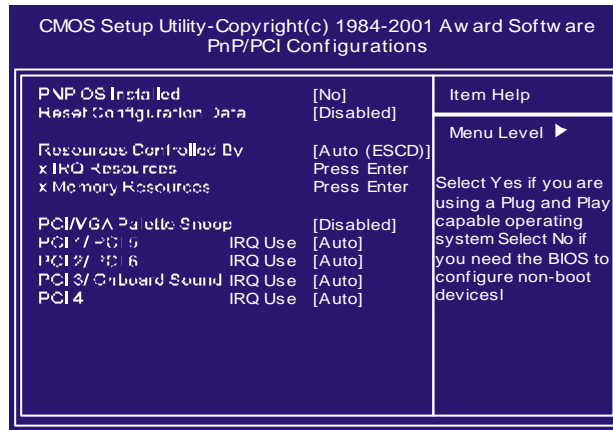

PNP OS Installed

The field specifies whether a Plug and Play operating system is installed.

[Yes, No (Default Value)]

Reset Configuration Data

Normally, you leave this field Disabled. Select Enabled to reset Extended System Configuration Data (ESCD) when you exit Setup if you have installed a new add-on and the system reconfiguration has caused such a serious conflict that the operating system can not boot.

[Enabled, Disabled (Default Value)]

Resources Controlled By

The Award Plug and Play BIOS has the capacity to automatically configure all of the boot and Plug and Play compatible devices. However, this capability means absolutely nothing unless you are using a Plug and Play operating system such as Windows 98/95/NT. If you set this field to "manual" choose specific resources by going into each of the sub menu that follows this field (a sub menu is preceded by a "Ø").

[Manual: Resources controlled by the user.

Auto (ESCD) (Default Value): Resources controlled by BIOS automatically]

IRQ Resources

When resources are controlled manually, assign each system interrupt a type, depending on the type of device using the interrupt.

IRQ3/4/5/7/9/10/11/12/14/15 assigned to

[PCI/ISA PnP (**Default Value**), Legacy ISA]

DMA Resources

This sub menu can let you control the memory resource.

ReservedMemoryBase

Reserved a low memory for the legacy device (non-PnP device).

[C800,CC00,D000,D400,D800,DC00,N/A (**Default Value**)]

ReservedMemoryLength

Reserved a low memory length for the legacy device (non-PnP device).

[8K(**DefaultValue**),16K,32K,64K]

PCI / VGA Palette Snoop

This field controls the ability of a primary PCI graphics controller to share a common palette with an ISA/VESA video or MPEG card.

Enabled	PCI VGA co-works with ISA MPEG card
Disabled (Default Vaule)	All cases except above.

PCI 1/5 IRQ, PCI 2/6 IRQ, PCI 3/Onboard RAID,
PCI 4 IRQ

These fields set how IRQ use is determined for each PCI slot. The default setting for each field is Auto, which uses auto-routing to determine IRQ use.

[Auto(**Default Value**)3,4,5,7,9,10,11,12,14,15]

PC Health Status

This page is monitoring your status of computer. On the screen displays CPU/System temperature, FAN speed, and voltages.

CMOS Setup Utility-Copyright(c) 1984-2001 Award Software		Item Help
PC Health Status		Menu Level ▶
CPU Warning Temperature	[Disabled]	
Current CPU Temperature	45 C/113 F	
Current SYS Temperature	0 C/ 32 F	
Current SYS Temperature	0 C/ 32 F	
Current CPUFAN Speed	4687 RPM	
Current SYSFAN1 Speed	0 RPM	
Current SYSFAN2 Speed	0 RPM	
Vcore_	1.68 V	
VTT.	1.48 V	
+3.3V	3.40V	
+ 5V	5.08V	
+12V	12.09V	
- 12V	12.11V	
- 5V	5.20V	
VBAT (V)	3.10V	
5VSB (V)	4.92V	
Shut down Temperature	[Disabled]	

IWILL Smart Setting

CMOS Setup Utility-Copyright(c) 1984-2001 Award Software		Item Help
IWILL Smart Setting		Menu Level ▶
The CPU Is	Pentium III - MMX	
The CPU ID Is	0681	
The CPU Expect Speed Is	133x 4.5 MHz	
CPU MicroCode Updated to	0011	
Spread Spectrum	[Disable]	
== IWILL Micro Stepping ==		
CPU Clock	[66]	
CPU Clock Ratio	[X 3.0]	
x DRAM Clock	[By SPD]	
CPU Vcore Setting	[Auto]	
BIOS-ROM Flash Protect	[Non-Flash]	

IWILL MicroStepping

MicroStepping

Microstepping is Iwill's another step forward to provides users a fuss free CPU frequency set up procedure. It contains two main functions, AutoDetecting CPUs speed and Micro Adjustable CPU FSB speed.

Auto Detecting CPU speed:

IWILL MicroStepping will auto detect the CPU's factory multiplier setting and CPU FSB to the factory default. This function provides a "fuss free" CPU setup process for the general users.

Micro Adjustable CPU FSB speed:

IWILL provides a user friendly overclocking function that allows users to experience the fun of overclocking. This function allows user to adjust CPU FSB by 1MHz interval. This is particularly useful when user wants to extract the most out of the purchased CPU. For example: you select from 133, 134, 135, 136, 137, 138MHz and up to the maximum speed that the system can sustained. In the time should overclocking failed, MicroStepping will auto detects the CPU's factory multiplier setting and set the CPU FSB to default 66MHz, to protect the CPU installed.

Spread Spectrum

This item configures radiation emitted from the system. When enabled, system will release less radiation

[Enabled, Disabled (**Default Value**)]

CPU Vcore Setting

This item display the current status of CPU voltages.

[Auto (**Default Value**), 1.125V, 1.150V, 1.175V, 1.200V, 1.225V, 1.250V, 1.275V, 1.300V, 1.325V, 1.350V, 1.375V, 1.400V, 1.425V, 1.450V, 1.525V, 1.550V, 1.575V, 1.600V, 1.625V, 1.650V, 1.675V, 1.700V, 1.725V, 1.750V, 1.775V, 1.800V, 1.825V, 1.850V]

BIOS-ROM Flash Protect

When select "Non flash", the BIOS ROM chip will be protecte to prevent injuring by Virus "please don't select Flashable" until you have to upgrade the latest BIOS.

[Non-Flash (**Default Value**), Flashable]

Load Fail Safe Defaults

When you press <Enter> on this item you get a confirmation dialog box with a message similar to: Pressing 'Y' loads the BIOS default values for the most stable, minimal-performance system operations.

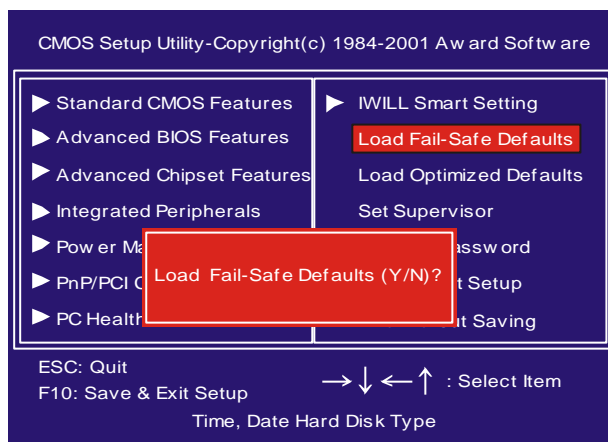

Load Optimized Defaults

When you press <Enter> on this item you get a confirmation dialog box with a message similar to:

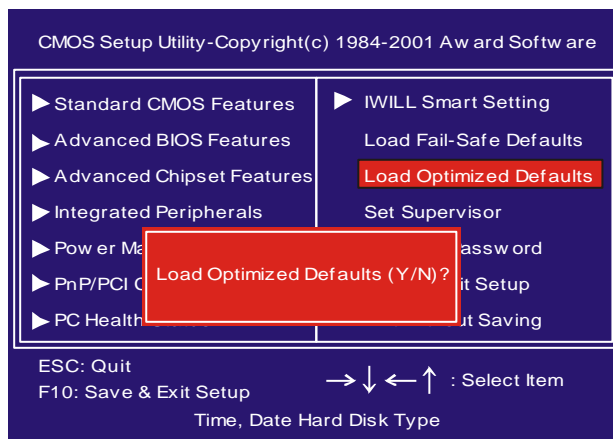

Set Supervisor/User Password Setting

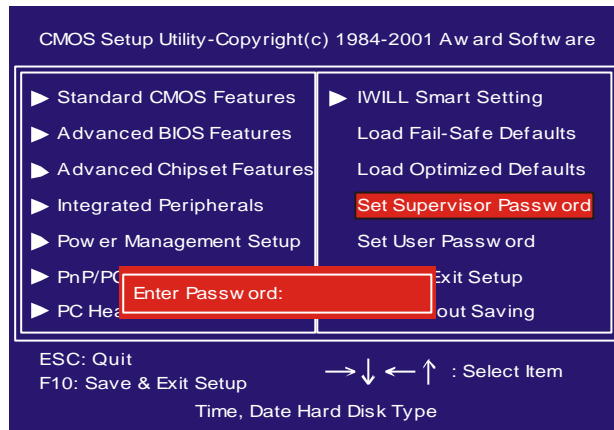

These setup pages are used for password setting. When a password has been enabled and the Security Option field is set as Setup, you will be required to enter the password every time you try to enter BIOS Setup program. This prevents an unauthorized person from changing any part of your system configuration. Additionally, if the Security Option field is set as Boot, the BIOS will request a password everytime your system boot. This would prevent unauthorized use of your computer.

If you wish to use this function, bring the cursor to this field, then press <Enter>. The computer will display the message, "Enter Password". Type your password and press <Enter>. After the message onfirm Password" is displayed, re-type your password. The Supervisor Password function will be in effect after you save and exit setup.

To disable a password, bring the cursor to this field, then press <Enter>. The computer will display the message, "Enter Password". Press <Enter>. A message will confirm that the password is disabled. Once the password is disabled, the system will boot and you can enter setup program freely.

Save & Exit Setup

Saves current CMOS value and exit BIOS setup program.

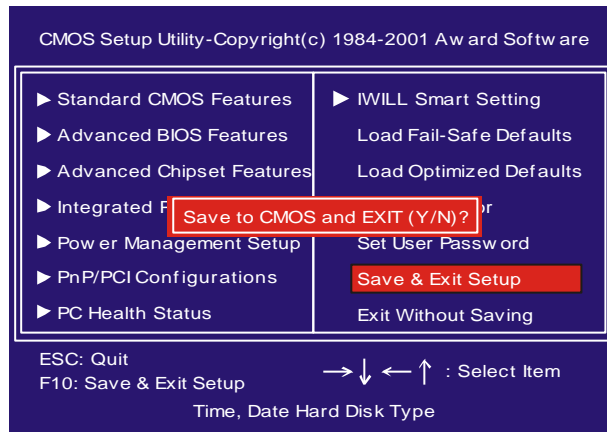

Exit Without Saving

Abandons all CMOS value changes and exits BIOS setup program.



On board Audio

Audio Features

Special Feature

1. Full-duplex playback and recording. Built-in 16-bit CODEC.
2. HRTF 3D positional audio, supporting both DirectSound 3D&A3D interfaces. Also supports earphones, 2/4/6 channel speakers mode.
3. Support Windows 98/Windows 2000 and Windows NT 4.0.
4. Built-in 32 OHM Earphone buffer.
5. MPU-401 Game/Midi port and legacy audio SB Pro support.
6. Downloadable Wave Table Synthesizer, supporting Direct Music.

Digital Audio (SPDIF IN/OUT)

1. Up to 24-bit stereo 44KHz sampling rate; voice playback/recording
2. Full-duplex playback and recording. 120dB audio quality measured.
3. Auto detectable SPDIF/IN signal level from 0.5V to 5V.

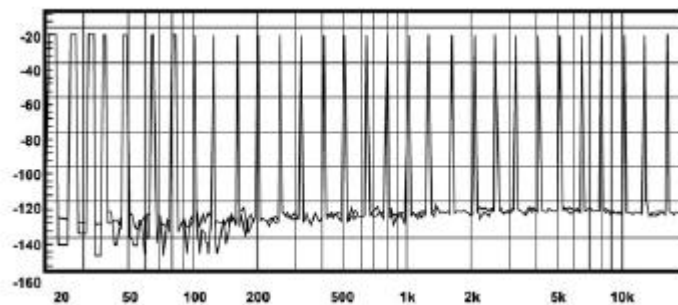

120 dB audio quality in playback, recording, and bypass modes.

StereoMixer

1. Stereo analog mixing from CD-Audio and Line-in
2. Stereo digital mixing from Voice, FM/Wave-table, and Digital CD-Audio
3. Mono mixing from MIC. Software adjustable volume.

Game and Midi Interface

Fully compatible with MPU-401 Midi UART and Sound Blaster
Midi mode/Standard IBM PC joystick/game port

IWILL 6Channel Audio/ SuperAudio (Optional)

Connectors and Jumpers

JP5	Audio Extension (Digital I/O) Connector
JP7	CD-SPDIF IN
JP10	Sub-w oofer/Center Select
Line-IN	LINE-IN Connect to the audio output port of stereo
Mic-IN	Connect to the Microphone (Mono)
Front- Speaker	Output to speakers with the amplifier or earphones or AUDIO-IN of home stereo
Rear-Speaker	Connect to the rear speakers while four/six channel speakers mode is enabled
Center/Sub-w oofer	Connect to the center speaker and sub-w oofer while six channel speakers mode is enabled
GAME/MIDI	Connect to Joystick or devices using MIDI interface
RCA SPDIF IN/OUT	Connects to digital audio devices such as DAT and MiniDisc recorders, via RCA input/output
Optical SPDIF IN/OUT	Connects to digital audio devices such as DAT and MiniDisc recorders, via optical input/output

JP10 function

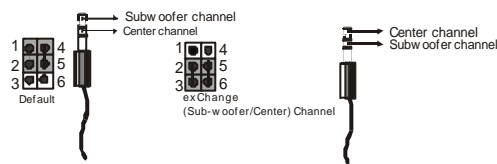

6Channel Audio

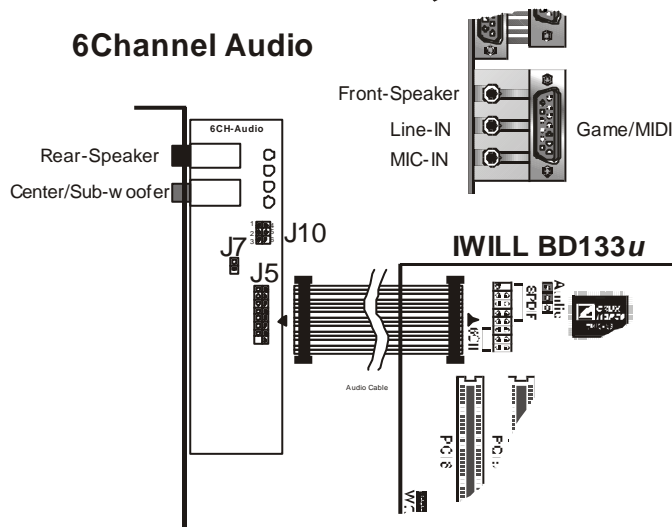

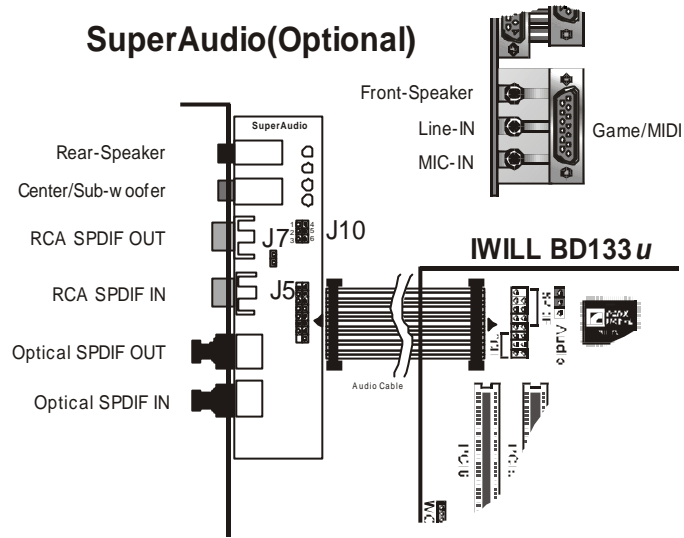

IWILL 6Channel Audio



IWILL SuperAudio (Optional)

Driver Installation

DOS Installation

Before beginning the installation, please make sure that your hard disk has sufficient space (min. 4MB). Insert the Power Installer CD into the CD-ROM Drive.

1. Change directory to PCI audio DOS drivers folder (ex. D:\DOSDRV) at DOS prompt, and type: *INSTALL*[Enter]
2. Type the DOS utilities path you want to install the file in.
3. Program will expand the file to the path you've specified.
4. Install program will add initial drivers into AUTOEXEC.BAT file.

Win 95/98/ME/2000 Installation

1. Click "Start" at Windows bottom-left corner.
2. Select "Run"
3. Key in the drive path where the installation CD and installation program are in; for example, "D:\SETUP.EXE"
4. Click "OK" to start the applications installation procedure, and follow the on-screen instructions to complete the installation.
5. When all the application software has been installed, please shut down Windows system, and reboot your system for new driver installation. System will install the device drivers automatically.

Win 95/98/ME/2000 Un-Installation

1. Click "Start"
2. Select "Program."
3. Find "Uninstall device drivers and applications" program in PCI audio applications.
4. Run it.
5. Follow the on-screen instructions to uninstall the device drivers or applications.

Windows NT4.0 Installation

We recommend that you have Microsoft Windows NT installed, and remove any existing sound drivers from your current system, before you install this PCI sound device driver.

1. Click "Start", move the highlight bar to "Setting", and select the "Control Panel".
2. Double-click "Multimedia."
3. Select "Devices", and press "Add"
4. Select "Unlisted or Updated Driver" in List of Drivers."
5. Specify the drive path where NT drivers are in (such as D:\NT40\DRV).
6. Select "C-Media CM8738," and press "OK".
7. Select proper I/O value.
8. Press "OK."
9. Restart the system when being asked.
10. Now, you have already installed the PCI Audio Adapter under Microsoft Windows NT 4.0 successfully. If you want to install the Windows applications, continue the following steps.
11. Click "Start"
12. Select "Run"
13. Key in drive path where the Windows NT application installation program are in;
for example, "D:\NT40\APP\SETUP.EXE"
14. Click "OK" to start the installation procedure, and follow the on-screen instructions to complete the installation. When all of application software has been installed, shut down the Windows NT system, then reboot your system.

The Audio Rack

Introduction

By means of a user-friendly interface (as easy as operating your home stereosystem), this PCI audio rack provides you with the control over your PC's audio functions, including the advantage of six speakers mode enable/disable, and perfect digital sound (SPDIF version ONLY) input/output control.

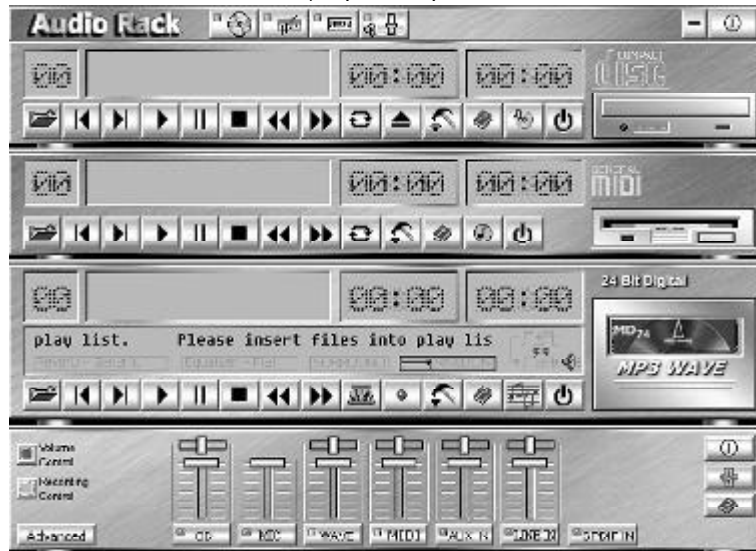

About Audio Rack

The Audio Rack is consisted of several major components.

Control Center

Controls the display of the PCI Audio Rack's components.



MIDI Player

MIDI Player can play MIDI files, *.mid/*.rmi, and allow you to create your own playlist.

MP3/Wave Player

Records and plays digital audio (mp3/wave) files. Allows you to create wave file playlists, and playback the wave files.

CD Player

Plays standard audio CDs. Allows you to create your favorite song playlists.

Mixer

Controls the volume level of your audio inputs and outputs

Mixer

Volume Control



For each output signal, the control slider regulates the loudness whereas a horizontal slider the balance between the two speakers. The mute button can temporarily stop the output without changing slider positions. A button with a lit LED means the output is available, and vice versa. Several output signals can usually be enabled at once.

Volume: This is the master control over all outputs. The power of an output signal is determined by both of the volume slider and the slider for the individual output. To modify all the outputs, adjust the volume slider. To change individual output(s), adjust its (their) slider(s).

CD: Regulates the CD drive audio input level.

MIC: Regulates the input level of microphone.

WAVE: Regulates wave (voice) playback levels.

MIDI: Regulates the MIDI music play level.

AUX IN: Regulates the Auxiliary input play level.

MONO IN: Regulates the Mono input level.

LINE IN: Regulates the Line-In levels.

Advanced: Regulates the advanced settings.

Recording Control



For each input signal, a control slider regulates the loudness whereas a horizontal slider the balance between the two channels. The select button can temporarily select input signal without changing slider positions. A button with a lit LED means it is available, and vice versa.

CD: Regulates the CD drive audio input level.

MIC: Regulates the input level of microphone.

WAVE: Regulates wave (voice) playback level.

FM: Regulates the FM music play level.

AUX IN: Regulates the Auxiliary input play level.

LINE IN: Regulates the Line-In level.

SPDIF IN: Enables the recording from SPDIF in. SPDIF-in is mutually exclusive with other input signals.

Advanced: Regulates the advanced settings.

Advanced - SPDIF

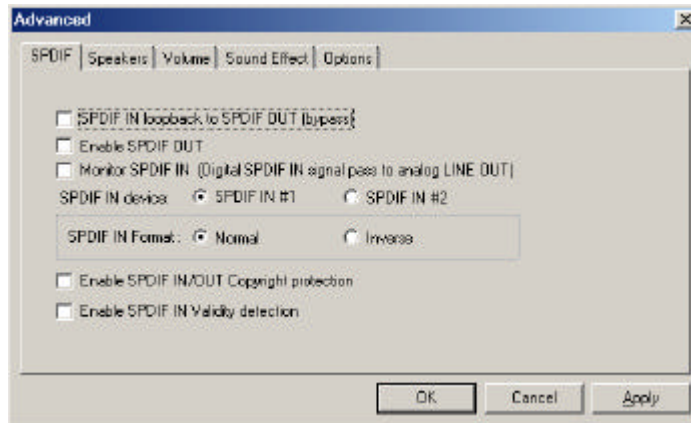

SPDIF dialog provides a full control over SPDIF IN/OUT functions. You can use these settings to connect your computer to other pieces of audio device, such as: Mini Disc players, amplifiers...etc.

Advanced - Speakers

Speakers dialog provides an interface allowing you to set your speakers configurations. First, You should make sure what model type your speakers are, and what the correct configurations are. And this dialog also shows the current status and functions of the phone jacks of your audio device. You can always refer to this to make sure whether or not the connections of your speakers and microphone are correct.

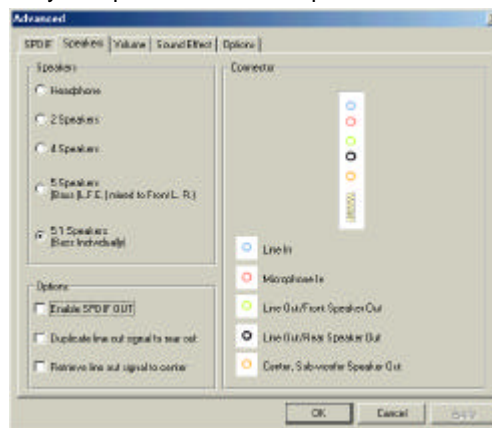

Power Installer CD

Software Installation

The attached Power Installer CD contains all the necessary drivers, utilities. It provides an easy way for users to install the needed drivers without going through a complicated process. The Power Installer CD is able to auto-detect and display the drivers, utilities needed for your motherboard.

What's inside Power Installer CD for this motherboard

Driver	Software Utility
<u>Intel INF Utility</u>	<u>PC-Cillin Anti-Virus</u>
<u>Security Driver</u>	<u>Hardware Monitor Utility</u>
<u>Award Patch File</u>	<u>Adobe Acrobat Reader</u>
<u>Software Audio Driver</u>	Make Driver
<u>User's Manual</u>	Exit

How to read the manual

The Power Installer CD supports the Auto Run program under Windows 98/95/2000 and Windows NT operating systems. All the necessary drivers, utilities and manual for this motherboard will show on the screen.

Power Installer does not support a keyboard at this moment. You must use a mouse to install it.

How to read the manual

This Power Installer CD includes detailed information of all manuals for every motherboard manufactured. Please insert the Power Installer CD into the CD-ROM drive; Click the "View Manual" item, and select the product that you want to view.

Making driver diskette

Before installing O.S.

This bootable Power Installer CD also allows you to boot up your system, even when the OS has not been installed. During the boot-up process, you can perform Diskette Creator, which will automatically make the driver diskettes you need. Follow the instructions below to make your own device driver floppy diskettes if you have a CD-ROM with IDE interface. If you have already installed SCSI CD-ROM, please make sure your SCSI host adapter supports bootable CD-ROM, and then proceed directly to step 8, and then finish the procedure.

STEP 1	First, power-on or boot your system.
STEP 2	Press key during boot sequence to enter CMOS Setup Utility .
STEP 3	Use arrow keys to select ADVANCED BIOS FEATURES on the menu, then press Enter .
STEP 4	Select First Boot Device and change the default setting to CDROM using Page Up /Page Down key.
STEP 5	Press <Esc> key to go back to CMOS SETUP Utility menu.
STEP 6	Press <F10> to select Save and Exit Setup.
STEP 7	Press Y then Enter to complete. Now you are able to boot up the system from the CD-ROM.
STEP 8	Insert the Power Installer CD into the CD-ROM drive and re-start the computer.
STEP 9	The Diskette Creator will now execute automatically for making your own driver diskettes.
STEP 10	Make the desired driver diskettes according to the instructions displayed on screen.

Under windows 98/95/NT

You may just click on the software **Make Driver Diskettes Utility** shown on screen, then select the driver you need, follow the messages shown on screen to complete.