

# **MP-6VIP-D+**

## **Motherboard**

### **User's Manual**

**Product Name:** MP-6VIP-D+  
**Manual Revision:** English, 1.00  
**Release Date:** April, 2000

---

## **Federal Communications Commission Statement**

This device complies with FCC Rules Part 15. Operation is subject to the following two conditions:

- ♦ This device may not cause harmful interference
- ♦ This device must accept any interference received, including interference that may cause undesired operation.

This equipment has been tested and found to comply with the limits for a Class B digital device, pursuant to Part 15 of the FCC Rules. These limits are designed to provide reasonable protection against harmful interference in a residential installation. This equipment generates, uses and can radiate radio frequency energy. If this equipment is not installed and used in accordance with the manufacturer's instructions, it may cause harmful interference to radio communications. However, there is no guarantee that interference will not occur in a particular installation. If this equipment does cause harmful interference to radio or television reception, which can be determined by turning the equipment off and on, the user is encouraged to try to correct the interference by one or more of the following measures:

- ♦ Reorient or relocate the receiving antenna.
- ♦ Increase the separation between the equipment and receiver.
- ♦ Connect the equipment to an outlet on a circuit different from that to which the receiver is connected.
- ♦ Consult the dealer or an experienced radio/TV technician for help.

The use of shielded cables for connection of the monitor to the graphics card is required to assure compliance with FCC regulations. Changes or modifications to this unit not expressly approved by the party responsible for compliance could void the user's authority to operate this equipment.

## **Canadian Department of Communications Statement**

This digital apparatus does not exceed the Class B limits for audio noise emissions from digital apparatuses set out in the Radio Interference Regulations of the Canadian Department of Communications.

## **Manufacturer's Disclaimer Statement**

The information in this document is subject to change without notice and does not represent a commitment on the part of the vendor. No warranty or representation, either expressed or implied, is made with respect to the quality, accuracy or fitness for any particular purpose of this document. The manufacturer reserves the right to make changes to the content of this document and/or the products associated with it at any time without obligation to notify any person or organization of such changes. In no event will the manufacturer be liable for direct, indirect, special, incidental or consequential damages arising out of the use or inability to use this product or documentation, even if advised of the possibility of such damages. This document contains materials protected by copyright. All rights are reserved. No part of this manual may be reproduced or transmitted in any form, by any means or for any purpose without expressed written consent of its authors. Product names appearing in this document are mentioned for identification purposes only. All **trademarks**, product names or brand names appearing in this document are registered property of their respective owners.

Copyright © Magic-Pro Computer Co., LTD.

All rights reserved

Author : Raymond

Printed in Taiwan

April 2000

**100%** POST-CONSUMER  
RECYCLED PAPER 

# CONTENT

## 65DVB

|  |    |
|--|----|
| VIA 82C693A SOCKET-370 .....           | 4  |
| MOTHERBOARD DIAGRAM .....              | 6  |
| CPU CLOCK SETTING .....                | 7  |
| JUMPER SETTING .....                   | 9  |
| DRIVERS & SOFTEARES INSTALLATION ..... | 12 |
| STANDARD CMOS SETUP .....              | 14 |
| BIOS FEATURES SETUP .....              | 16 |
| CHIPSET FEATURES SETUP .....           | 20 |
| POWER MANAGEMENT SETUP .....           | 23 |
| PnP/PCI CONFIGURATION SETUP .....      | 27 |
| LOAD SETUP DEFAULTS .....              | 30 |
| CPU SPEED SETTING .....                | 31 |
| INTEGRATED PERIPHERALS .....           | 33 |
| SUPERVISOR/USER PASSWORD .....         | 37 |
| IDE HDD AUTO DETECTION .....           | 38 |
| SAVE & EXIT SETUP .....                | 38 |

**EXIT WITHOUT SAVING ..... 38**

**Appendix A**

**Flash Memory Update Installation ..... 39**

**Appendix B**

**Driver installation ..... 40**



# MP-6VIP-D+

VIA 82C693A SOCKET-370

---

## F E A T U R E

### ■ PROCESSOR

- Supports Intel PPGA Celeron 370 / FC-PGA Pentium III (Coppermine) CPUs 300 ~ 750 or higher.
- Supports VIA Cyrix III (Joshua) CPUs at 433/ 466/ 500/ 533MHz (PR rating) or higher.
- Supports 66/ 75\*/ 83\*/ 100/ 103\*/ 105\*/ 124\*/ 133/ 140\*/ 150\*MHz system bus speeds.
- Clock multipliers up to 8x.

### ■ CHIPSET

- VIA 82C693A + 686A (133MHz FSB ).

### ■ ONBOARD SOUND

- Built-In AC'97 Audio Codec.
- Supports Line-In, Mic-In, Speaker-Out / Line-Out connector and MIDI port.

### ■ SYSTEM MEMORY

- 3x 3.3V DIMM sockets.
- 8MB to 768MB DRAM size.
- ECC or Parity support.

### ■ SLOT

- 1x AGP slot supports 1x / 2x mode bus; 1x AMR (Audio Modem Riser)slot; 5x PCI Bus Master slots; 1x ISA slot.

### ■ ONBOARD I/O

- 2x Ultra ATA33/66 Bus Master IDE ports.
- 4x USB ports.
- 1x PS/2 mouse connector and 1x PS/2 keyboard connector.
- 1x 2.88MB Floppy port, 2x High Speed 16550A UART ports and 1x IrDA TX / RX Header.

### ■ POWER

- ATX power supply connector.
- Power-On by LAN(WOL), RTC Alarm, Modem Ring.

### ■ BIOS

- 2MB FLASH BIOS.
- Licensed AWARD BIOS, supports SCSI / ZIP / LS-120 / CD-ROM boot and ACPI Power Management.

■ **FORM FACTOR / PCB**

- ATX, 4 layers PCB, 18.5cm x 30.5cm size.

■ **OTHER FEATURES**

- Hardware Monitor.
- Supports BIOS Writing Protection.

MOTHERBOARD DIAGRAM

Default setting: Intel Celeron 300A/66MHz

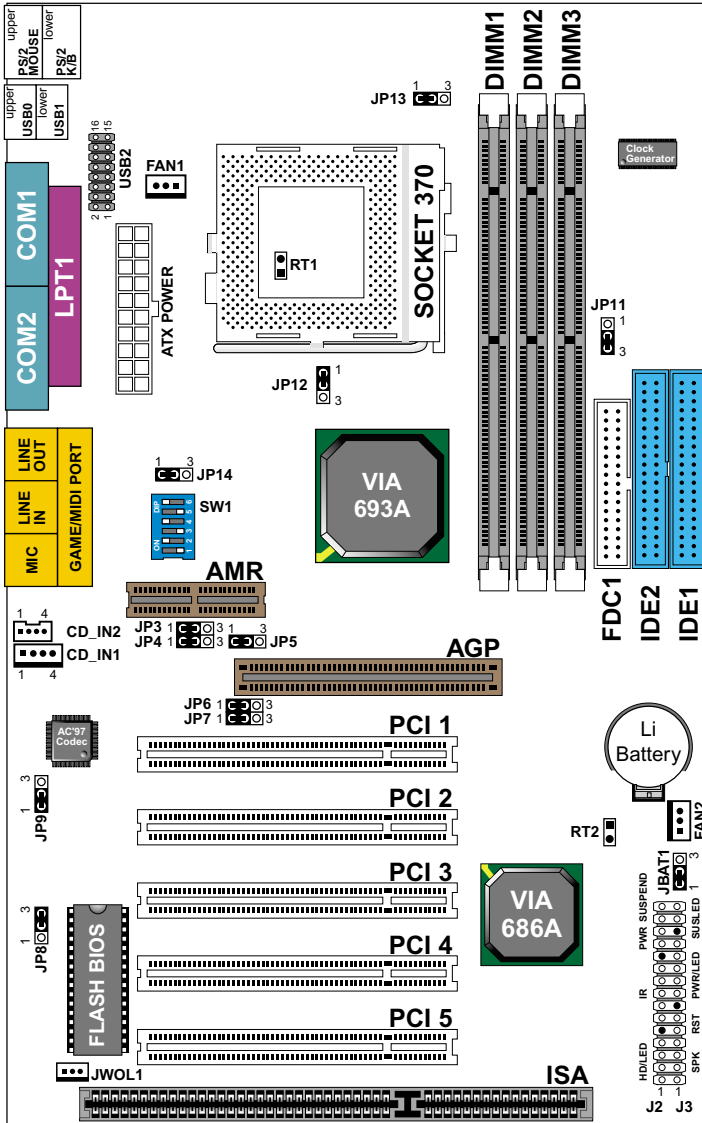

NOTE: For 100MHz/133MHz CPU environment, the SDRAM sepc must comply with PC-100/PC-133 spec.

## CPU CLOCK SETTING

### CPU Type Configuration

| CPU MODEL  | SW1  | CPU RATIO |     |    |    |    |     |     |     |   |   |   |   |   |   |  |  |      |
|--|--|-----------|-----|----|----|----|-----|-----|-----|---|---|---|---|---|---|--|--|------|
| Celeron 233/66   | ON <table border="1" style="display: inline-table; vertical-align: middle;"> <tr><td>ON</td><td>ON</td><td>ON</td><td>ON</td></tr> <tr><td>ON</td><td>OFF</td><td>OFF</td><td>OFF</td></tr> <tr><td>1</td><td>2</td><td>3</td><td>4</td></tr> <tr><td>5</td><td>6</td><td></td><td></td></tr> </table> | ON        | ON  | ON | ON | ON | OFF | OFF | OFF | 1 | 2 | 3 | 4 | 5 | 6 |  |  | 3.5x |
| ON   | ON   | ON        | ON  |    |    |    |     |     |     |   |   |   |   |   |   |  |  |      |
| ON   | OFF  | OFF       | OFF |    |    |    |     |     |     |   |   |   |   |   |   |  |  |      |
| 1  | 2  | 3         | 4   |    |    |    |     |     |     |   |   |   |   |   |   |  |  |      |
| 5  | 6  |           |     |    |    |    |     |     |     |   |   |   |   |   |   |  |  |      |
| Celeron 266/66<br>Pentium III 533EB/133*                         | ON <table border="1" style="display: inline-table; vertical-align: middle;"> <tr><td>ON</td><td>ON</td><td>ON</td><td>ON</td></tr> <tr><td>ON</td><td>OFF</td><td>OFF</td><td>OFF</td></tr> <tr><td>1</td><td>2</td><td>3</td><td>4</td></tr> <tr><td>5</td><td>6</td><td></td><td></td></tr> </table> | ON        | ON  | ON | ON | ON | OFF | OFF | OFF | 1 | 2 | 3 | 4 | 5 | 6 |  |  | 4.0x |
| ON   | ON   | ON        | ON  |    |    |    |     |     |     |   |   |   |   |   |   |  |  |      |
| ON   | OFF  | OFF       | OFF |    |    |    |     |     |     |   |   |   |   |   |   |  |  |      |
| 1  | 2  | 3         | 4   |    |    |    |     |     |     |   |   |   |   |   |   |  |  |      |
| 5  | 6  |           |     |    |    |    |     |     |     |   |   |   |   |   |   |  |  |      |
| Celeron 300/66<br>Pentium III 600EB/133*                         | ON <table border="1" style="display: inline-table; vertical-align: middle;"> <tr><td>ON</td><td>ON</td><td>ON</td><td>ON</td></tr> <tr><td>ON</td><td>OFF</td><td>OFF</td><td>OFF</td></tr> <tr><td>1</td><td>2</td><td>3</td><td>4</td></tr> <tr><td>5</td><td>6</td><td></td><td></td></tr> </table> | ON        | ON  | ON | ON | ON | OFF | OFF | OFF | 1 | 2 | 3 | 4 | 5 | 6 |  |  | 4.5x |
| ON   | ON   | ON        | ON  |    |    |    |     |     |     |   |   |   |   |   |   |  |  |      |
| ON   | OFF  | OFF       | OFF |    |    |    |     |     |     |   |   |   |   |   |   |  |  |      |
| 1  | 2  | 3         | 4   |    |    |    |     |     |     |   |   |   |   |   |   |  |  |      |
| 5  | 6  |           |     |    |    |    |     |     |     |   |   |   |   |   |   |  |  |      |
| Celeron 333/66<br>Pentium III 500E/100*<br>Pentium III 667B/133* | ON <table border="1" style="display: inline-table; vertical-align: middle;"> <tr><td>ON</td><td>ON</td><td>ON</td><td>ON</td></tr> <tr><td>ON</td><td>OFF</td><td>OFF</td><td>OFF</td></tr> <tr><td>1</td><td>2</td><td>3</td><td>4</td></tr> <tr><td>5</td><td>6</td><td></td><td></td></tr> </table> | ON        | ON  | ON | ON | ON | OFF | OFF | OFF | 1 | 2 | 3 | 4 | 5 | 6 |  |  | 5.0x |
| ON   | ON   | ON        | ON  |    |    |    |     |     |     |   |   |   |   |   |   |  |  |      |
| ON   | OFF  | OFF       | OFF |    |    |    |     |     |     |   |   |   |   |   |   |  |  |      |
| 1  | 2  | 3         | 4   |    |    |    |     |     |     |   |   |   |   |   |   |  |  |      |
| 5  | 6  |           |     |    |    |    |     |     |     |   |   |   |   |   |   |  |  |      |
| Celeron 366/66<br>Pentium III 550E/100*<br>Pentium III 733B/133* | ON <table border="1" style="display: inline-table; vertical-align: middle;"> <tr><td>ON</td><td>ON</td><td>ON</td><td>ON</td></tr> <tr><td>ON</td><td>OFF</td><td>OFF</td><td>OFF</td></tr> <tr><td>1</td><td>2</td><td>3</td><td>4</td></tr> <tr><td>5</td><td>6</td><td></td><td></td></tr> </table> | ON        | ON  | ON | ON | ON | OFF | OFF | OFF | 1 | 2 | 3 | 4 | 5 | 6 |  |  | 5.5x |
| ON   | ON   | ON        | ON  |    |    |    |     |     |     |   |   |   |   |   |   |  |  |      |
| ON   | OFF  | OFF       | OFF |    |    |    |     |     |     |   |   |   |   |   |   |  |  |      |
| 1  | 2  | 3         | 4   |    |    |    |     |     |     |   |   |   |   |   |   |  |  |      |
| 5  | 6  |           |     |    |    |    |     |     |     |   |   |   |   |   |   |  |  |      |
| Celeron 400/66<br>Pentium III 600E/100*                          | ON <table border="1" style="display: inline-table; vertical-align: middle;"> <tr><td>ON</td><td>ON</td><td>ON</td><td>ON</td></tr> <tr><td>ON</td><td>OFF</td><td>OFF</td><td>OFF</td></tr> <tr><td>1</td><td>2</td><td>3</td><td>4</td></tr> <tr><td>5</td><td>6</td><td></td><td></td></tr> </table> | ON        | ON  | ON | ON | ON | OFF | OFF | OFF | 1 | 2 | 3 | 4 | 5 | 6 |  |  | 6.0x |
| ON   | ON   | ON        | ON  |    |    |    |     |     |     |   |   |   |   |   |   |  |  |      |
| ON   | OFF  | OFF       | OFF |    |    |    |     |     |     |   |   |   |   |   |   |  |  |      |
| 1  | 2  | 3         | 4   |    |    |    |     |     |     |   |   |   |   |   |   |  |  |      |
| 5  | 6  |           |     |    |    |    |     |     |     |   |   |   |   |   |   |  |  |      |
| Celeron 433/66<br>Pentium III 650/100*                           | ON <table border="1" style="display: inline-table; vertical-align: middle;"> <tr><td>ON</td><td>ON</td><td>ON</td><td>ON</td></tr> <tr><td>ON</td><td>OFF</td><td>OFF</td><td>OFF</td></tr> <tr><td>1</td><td>2</td><td>3</td><td>4</td></tr> <tr><td>5</td><td>6</td><td></td><td></td></tr> </table> | ON        | ON  | ON | ON | ON | OFF | OFF | OFF | 1 | 2 | 3 | 4 | 5 | 6 |  |  | 6.5x |
| ON   | ON   | ON        | ON  |    |    |    |     |     |     |   |   |   |   |   |   |  |  |      |
| ON   | OFF  | OFF       | OFF |    |    |    |     |     |     |   |   |   |   |   |   |  |  |      |
| 1  | 2  | 3         | 4   |    |    |    |     |     |     |   |   |   |   |   |   |  |  |      |
| 5  | 6  |           |     |    |    |    |     |     |     |   |   |   |   |   |   |  |  |      |
| Celeron 466/66<br>Pentium III 700/100*                           | ON <table border="1" style="display: inline-table; vertical-align: middle;"> <tr><td>ON</td><td>ON</td><td>ON</td><td>ON</td></tr> <tr><td>ON</td><td>OFF</td><td>OFF</td><td>OFF</td></tr> <tr><td>1</td><td>2</td><td>3</td><td>4</td></tr> <tr><td>5</td><td>6</td><td></td><td></td></tr> </table> | ON        | ON  | ON | ON | ON | OFF | OFF | OFF | 1 | 2 | 3 | 4 | 5 | 6 |  |  | 7.0x |
| ON   | ON   | ON        | ON  |    |    |    |     |     |     |   |   |   |   |   |   |  |  |      |
| ON   | OFF  | OFF       | OFF |    |    |    |     |     |     |   |   |   |   |   |   |  |  |      |
| 1  | 2  | 3         | 4   |    |    |    |     |     |     |   |   |   |   |   |   |  |  |      |
| 5  | 6  |           |     |    |    |    |     |     |     |   |   |   |   |   |   |  |  |      |
| Celeron 500/66<br>Pentium III 750/100*                           | ON <table border="1" style="display: inline-table; vertical-align: middle;"> <tr><td>ON</td><td>ON</td><td>ON</td><td>ON</td></tr> <tr><td>ON</td><td>OFF</td><td>OFF</td><td>OFF</td></tr> <tr><td>1</td><td>2</td><td>3</td><td>4</td></tr> <tr><td>5</td><td>6</td><td></td><td></td></tr> </table> | ON        | ON  | ON | ON | ON | OFF | OFF | OFF | 1 | 2 | 3 | 4 | 5 | 6 |  |  | 7.5x |
| ON   | ON   | ON        | ON  |    |    |    |     |     |     |   |   |   |   |   |   |  |  |      |
| ON   | OFF  | OFF       | OFF |    |    |    |     |     |     |   |   |   |   |   |   |  |  |      |
| 1  | 2  | 3         | 4   |    |    |    |     |     |     |   |   |   |   |   |   |  |  |      |
| 5  | 6  |           |     |    |    |    |     |     |     |   |   |   |   |   |   |  |  |      |
| Celeron 533/66   | ON <table border="1" style="display: inline-table; vertical-align: middle;"> <tr><td>ON</td><td>ON</td><td>ON</td><td>ON</td></tr> <tr><td>ON</td><td>OFF</td><td>OFF</td><td>OFF</td></tr> <tr><td>1</td><td>2</td><td>3</td><td>4</td></tr> <tr><td>5</td><td>6</td><td></td><td></td></tr> </table> | ON        | ON  | ON | ON | ON | OFF | OFF | OFF | 1 | 2 | 3 | 4 | 5 | 6 |  |  | 8.0x |
| ON   | ON   | ON        | ON  |    |    |    |     |     |     |   |   |   |   |   |   |  |  |      |
| ON   | OFF  | OFF       | OFF |    |    |    |     |     |     |   |   |   |   |   |   |  |  |      |
| 1  | 2  | 3         | 4   |    |    |    |     |     |     |   |   |   |   |   |   |  |  |      |
| 5  | 6  |           |     |    |    |    |     |     |     |   |   |   |   |   |   |  |  |      |

NOTE: " \* " - Pentium III Coppermin FC-PGA CPUs.  
 "B" - 133MHz System Bus Frequency;  
 "E" - processor with "Advanced Transfer Cache".



**SW1 DIP1 ~ DIP4: Bus Ratio Select**

| SW1 DIP1 ~ DIP4 SETTING |    |  |             |    |  |
|-------------------------|----|--|-------------|----|--|
| <b>3.0x</b>             | ON |  | <b>3.5x</b> | ON |  |
|                         | ON |  |             | ON |  |
| <b>4.0x</b>             | ON |  | <b>4.5x</b> | ON |  |
|                         | ON |  |             | ON |  |
| <b>5.0x</b>             | ON |  | <b>5.5x</b> | ON |  |
|                         | ON |  |             | ON |  |
| <b>6.0x</b>             | ON |  | <b>6.5x</b> | ON |  |
|                         | ON |  |             | ON |  |
| <b>7.0x</b>             | ON |  | <b>7.5x</b> | ON |  |
|                         | ON |  |             | ON |  |
| <b>8.0x</b>             | ON |  |             |    |  |
|                         | ON |  |             |    |  |

**SW1 DIP5 ~ DIP6: Bus Clock Select**

| SW1 DIP5 ~ DIP6                            |    | JP11: FSB Select |
|--|----|------------------|
| <b>66/100/133MHz Auto Select (default)</b> | ON | 1<br>3           |
| <b>100MHz</b>                              | ON | 1<br>3           |
| <b>133MHz</b>                              | ON | 1<br>3           |

## JUMPER SETTING

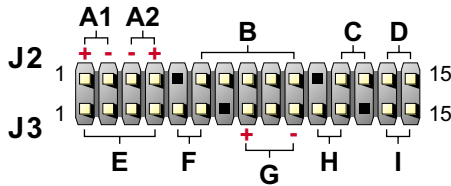

- |                    |                   |
|--------------------|-------------------|
| A1: 1st HDD LED    | A2: 2nd HDD LED   |
| B. : INFRARED (IR) | C. : POWER SWITCH |
| D. : NONE          | E. : SPEAKER      |
| F. : RESET SWITCH  | G. : POWER LED    |
| H. : NONE          | I. : SUSPEND LED  |

### ■ FAN#: Onboard FAN (12V) Connector.

| FAN# | FUNCTION   |
|------|------------|
| FAN1 | CPU FAN    |
| FAN2 | SYSTEM FAN |





### ■ JP3 / JP4: USB Port Select (1)

| USB Port Select                                | JP3 / JP4 |
|--|-----------|
| Redirect USB port3 to USB2 connector (default) |           |
| Redirect USB port3 to AMR                      |           |

### ■ JP6 / JP7: USB Port Select (2)



| USB Port Select                                | JP6 / JP7 |
|--|-----------|
| Redirect USB port2 to USB2 connector (default) |           |
| Redirect USB port2 to AGP                      |           |

■ **JP5 / JP9: AC'97 Codec Control**







| AC'97 Codec       | JP5 / JP9   |
|-------------------|---|
| Disabled          | JP5  JP9  |
| Enabled (default) | JP5  JP9  |

■ **JP8: Power Lost Resume**

This feature must work with BIOS. Please refer to the BIOS "Power On After PWR-Fail" sector.



| Power Lost Resume | JP8   |
|-------------------|---|
| Enabled           |  |
| Normal (default)  |  |

■ **JP12 / JP13 / JP14: Intel / Cyrix CPU Select**

| CPU Type                   | JP12   | JP13  | JP14  |
|----------------------------|--|---|---|
| Intel CPU (default)        |   |    |    |
| VIA Cyrix III (Joshua) CPU |  |  |  |

■ **JBAT1: Clear CMOS Data**

Before you clear the CMOS data, it's necessary to turn the power off first (including +5V standby power). Otherwise, the system may work abnormally or malfunction.

| CMOS Status           | JBAT1   |
|-----------------------|---|
| Retain Data (default) |  |
| Clear CMOS Data       |  |



## DRIVERS & SOFTWARES INSTALLATION

---

### *Onboard AC'97 Audio Codec Controller driver installation*

For Windows95 / Windows98:

1. Go to CD-ROM directory, we suggest that's D:\.
2. Find and run D:\MB\VIA\AUDIO\SETUP.EXE
3. The installation will detect your O.S. to install relative files into your system.
4. Reboot the computer.

**NOTE 1: IF USER WANTS TO USE EXTERNAL SOUND CARD, USER MUST RUN BIOS PROGRAM TO DISABLE "Onchip Sound" OPTION IN THE "Chipset Feature Setup" AND "Onboard Legacy Audio" OPTION IN THE "Integrated Pheripherals".**

**NOTE 2: UNDER WINDOWS 95, USER MUST INSTALL DirectX AND USBSUPP.EXE FOR AGP ENVIRONMENT.**

**NOTE 3: " VIA SERVICE PACK 4 ", " VIA USB FILTER DRIVER " & " VIA HARDWARE MONITOR " installation, please refer to Appendix B.**

This VIA 82C693A chipset comes with the AWARD BIOS from AWARD Software Inc. Enter the AWARD BIOS program Main Menu by:

1. Turn on or reboot the system. After a series of diagnostic checks, the following message will appear:

PRESS <DEL> TO ENTER SETUP

2. Press the <DEL> key and the main program screen will appear as follows:

ROM PCI/ISA BIOS (2A6LGSNC)  
CMOS SETUP UTILITY  
AWARD SOFTWARE, INC.

|                                       |   |
|---------------------------------------|---|
| STANDARD CMOS SETUP                   | CPU SPEED SETTING                                 |
| BIOS FEATURES SETUP                   | INTEGRATED PERIPHERALS                            |
| CHIPSET FEATURES SETUP                | SUPERVISOR PASSWORD                               |
| POWER MANAGEMENT SETUP                | USER PASSWORD                                     |
| PNP/PCI CONFIGURATION                 | IDE HDD AUTO DETECTION                            |
| LOAD SETUP DEFAULTS                   | SAVE & EXIT SETUP                                 |
|                                       | EXIT WITHOUT SAVING                               |
| Esc : Quit<br>F10 : Save & Exit Setup | ↑ ↓ → ← : Select Item<br>(Shift)F2 : Change Color |

3. Using the arrows on your keyboard, select an option, and press <Enter>. Modify the system parameter to reflect the options installed in your system.
4. You may return to the Main Menu anytime by pressing <ESC>.
5. In the Main Menu, "SAVE AND EXIT SETUP" saves your changes and reboots the system, and "EXIT WITHOUT SAVING" ignores your changes and exits the program.

## STANDARD CMOS SETUP

Standard CMOS Setup allows you to record some basic system hardware configuration and set the system clock and error handling. You only need to modify the configuration values of this option when you change your system hardware configuration or the configuration stored in the CMOS memory gets lost or damaged.

Run the Standard CMOS Setup as follows:

1. Choose "STANDARD CMOS SETUP" from the Main Menu and a screen with a list of options will appear.
2. Use one of the arrow keys to move between options and modify the selected options by using PgUp/PgDn/+/- keys.

ROM PCI/ISA BIOS (2A69KSNH)  
STANDARD CMOS SETUP  
AWARD SOFTWARE, INC.

|   |  |
|---|--|
| Date (mm:dd:yy) : Tue, Oct 19 1999                                    |  |
| Time (hh:mm:ss) : 15 : 6 : 26   |  |
| HARD DISK   | TYPE    SIZE    CYLS    HEAD    PRECOMP    LANDZ    SECTOR    MODE |
| <hr/>   |  |
| Primary Master  | : Auto    0M    0    0    0    0    0    AUTO                      |
| Primary Slave   | : Auto    0M    0    0    0    0    0    AUTO                      |
| Secondary Master  | : Auto    0M    0    0    0    0    0    AUTO                      |
| Secondary Slave   | : Auto    0M    0    0    0    0    0    AUTO                      |
| Drive A   | : 1.44, 3.5 in.  |
| Drive B   | : None   |
| Video   | : EGA/VGA  |
| Halt On   | : All Errors   |
| Base Memory : 640K<br>Extended Memory : 64512K<br>Other Memory : 384K |  |
| <hr/>   |  |
| Total Memory : 65536K   |  |
| Esc : Quit  | ↑ ↓ → ← : Select Item  |
| F1 : Help   | (Shift) F2 : Change Color  |
| PU/PD/+/- : Modify  |  |

---

|   |  |
|---|--|
| <b>Date (mm:dd:yy)</b>                        | Set the current date and time.   |
| <b>Time (hh:mm:ss)</b>                        |  |
| <b>Primary (Secondary)<br/>Master / Slave</b> | This field records the specification for all non-SCSI Hard Disk Drives installed in your system. Refer to the respective documentation on how to install the drives.                                       |
| <b>Drive A / B</b>                            | Set the field to the type(s) of Floppy Disk drive(s) installed in your system.<br>The choice:<br>360KB, 5.25in.<br>1.2MB, 5.25in.<br>720KB, 3.5in.<br>1.44MB, 3.5in.<br>2.88MB, 3.5in.                     |
| <b>Video</b>                                  | Set the field to the type of video display card installed in your system.<br>The choice:<br>Monochrome,<br>Color 40x25,<br>EGA / VGA, (default)<br>Color 80x25   |
| <b>Halt On</b>                                | Set this warning feature for the type of errors that will cause the system to halt.<br>The choice:<br>All Errors, (defaults)<br>No Errors,<br>All But Keyboard,<br>All But Diskette,<br>All But Disk / Key |

3. Press <ESC> and follow the screen instructions to save or disregard your setting.



## BIOS FEATURES SETUP

BIOS Features Setup allows you to improve your system performance or set up system features according to your preference.

Run the BIOS Features Setup as follows:

1. Choose "BIOS FEATURES SETUP" from the Main Menu and a screen with a list of options will appear.

ROM PCI/ISA BIOS (2A6LGSNC)  
BIOS FEATURES SETUP  
AWARD SOFTWARE, INC.

|                            |            |                          |                       |
|----------------------------|------------|--------------------------|-----------------------|
| Virus Warning              | : Disabled | Video BIOS Shadow        | : Enabled             |
| CPU Internal Cache         | : Enabled  | C8000-CBFFF Shadow       | : Disabled            |
| External Cache             | : Enabled  | CC000-CFFFF Shadow       | : Disabled            |
| CPU L2 Cache ECC Checking  | : Enabled  | D0000-D3FFF Shadow       | : Disabled            |
| Processor Number Feature   | : Disabled | D4000-D7FFF Shadow       | : Disabled            |
| Quick Power On Self Test   | : Enabled  | D8000-DBFFF Shadow       | : Disabled            |
| Boot Sequence              | : A,C,SCSI | DC000-DFFFF Shadow       | : Disabled            |
| Swap Floppy Drive          | : Disabled |                          |                       |
| Boot Up Floppy Seek        | : Disabled |                          |                       |
| Boot Up NumLock Status     | : On       |                          |                       |
| IDE HDD Block Mode         | : Enabled  |                          |                       |
| Gate A20 Option            | : Fast     |                          |                       |
| Memory Parity/ECC Check    | : Disabled |                          |                       |
| Typematic Rate Setting     | : Disabled |                          |                       |
| Typematic Rate (Chars/Sec) | : 6        |                          |                       |
| Typematic Delay (Msec)     | : 250      | ESC : Quit               | ↑ ↓ → ← : Select Item |
| Security Option            | : Setup    | F1 : Help                | PU/PD/+/- : Modify    |
| PCI/VGA Palette Snoop      | : Disabled | F5 : Old Value           | (Shift)F2 : Color     |
| OS Select For DRAM > 64MB  | : Non-OS2  | F7 : Load Setup Defaults |                       |

2. Use one of the arrow keys to move between options and modify the selected options by using PgUp/PgDn/+/- keys. An explanation of the <F>keys follows:

<F1>: "Help" gives options available for each item.

<Shift> + <F2>: Change BIOS screen color.

<F5>: Get the previous values. These values are the values with the user started in the current session.

<F6>: Load all options with the BIOS default values.

<F7>: Load all options with the Setup default values.

---

|                                  |  |
|----------------------------------|--|
| <b>Virus Warning</b>             | <p>Enabled: Activates automatically when the system boots up causing a warning message to appear if there is anything attempting to access the boot sector or Hard Disk partition table.</p> <p>Disabled: No warning message will appear when there is something attempting to access the boot sector or Hard Disk partition table.</p> <div style="border: 1px solid black; padding: 5px; margin-top: 10px;"><p><b>Note: Many diagnostic (or boot manager) programs which attempt to access the boot sector table can cause the above warning message. If you will be running such a program, we recommend that you disable the virus protection first.</b></p></div> |
| <b>CPU Internal Cache</b>        | <p>Choose Enabled (default) or Disabled. This option allows user to enable or disable the CPU internal cache.</p>  |
| <b>External Cache</b>            | <p>Choose Enabled (default) or Disabled. This option allows user to enable or disable the external cache memory.</p>   |
| <b>CPU L2 Cache ECC Checking</b> | <p>Choose Enabled (default) or Disabled.</p>   |
| <b>Processor Number Feature</b>  | <p>Choose Enabled or Disabled (default).</p>   |
| <b>Quick Power On Self Test</b>  | <p>Choose Enabled (default) or Disabled. This option allows user to speed up the Power-On-Self-Test routine.</p>   |
| <b>Boot Sequence</b>             | <p>Default is "A , C, SCSI". This option determines which drive to boot at first for an operating system.</p>  |
| <b>Swap Floppy Drive</b>         | <p>Default is "A, C, SCSI". This option determines which drive to boot at first for an operating system.</p>   |

|                                    |   |
|------------------------------------|---|
| <b>Boot Up Floppy Seek</b>         | Enabled (default): During POST, BIOS checks the track number for Floppy Disk drive to see whether it's 40 or 80 tracks.<br>Disabled: During POST, BIOS will not check the track number for Floppy Disk drive.   |
| <b>Boot Up NumLock Status</b>      | On (default): Activate the NumLock function at boot up.<br>Off: Close the NumLock function at boot up.  |
| <b>IDE HDD Block Mode</b>          | Choose Enabled (default) or Disabled. If your hard disk is larger than 540MB, choose Enabled. If you are using IDE HDD AUTO DETECTION option, then BIOS will choose this option automatically.<br><div style="border: 1px solid black; padding: 5px; margin-top: 10px;"><b>Note: Some older model HDDs do not provide this feature.</b></div> |
| <b>Gate A20 Option</b>             | Choose Normal or Fast (default): This option allows the RAM to access the memory above 1MB by using the fast gate A20 line.   |
| <b>Memory Parity / ECC Check</b>   | Choose Enabled or Disabled (default).   |
| <b>Typematic Rate Setting</b>      | Choose Enabled or Disabled (default): Enable this option to adjust the deystroke repeat rate.   |
| <b>Typematic Rate (Char / Sec)</b> | Range between 6 (default) and 30 characters per second. This option controls the speed of repeating keystrokes.   |
| <b>Typematic Delay (Msec)</b>      | Choose 250 (default), 500, 750 and 1000. This option sets the time interval for displaying the first and the second characters.   |
| <b>Security Option</b>             | Choose System or Setup (default). This option prevents unauthorized system boot up or use of BIOS Setup.  |

|  |  |
|--|--|
| <b>PCI / VGA Palette Snoop</b>           | Choose Enabled or Disabled (default). It determines whether or not the MPEG ISA cards can work with PCI / AGP. |
| <b>OS Select for DRAM &gt; 64MB</b>      | Non-OS2 (default): For Non-OS/2 operating system.<br>OS: For OS/2 operating system.                            |
| <b>Video BIOS Shadow</b>                 | Enabled (default): Map the VGA BIOS to system RAM.<br>Disabled: Don't map the VGA BIOS to system RAM.          |
| <b>C8000-CBFFF to DC000-DFFFF Shadow</b> | These options are used to shadow other expansion card ROMs.  |

3. Press <ESC> and follow the screen instructions to save or disregard your setting.

## CHIPSET FEATURES SETUP

Chipset Features Setup changes the values of the chipset registers. These registers control the system options.

Run the Chipset Features Setup as follows:

1. Choose "CHIPSET FEATURES SETUP" from the Main Menu and a screen with a list of options will appear.
2. Use one of the arrow keys to move between options and modify the selected options by using PgUp/PgDn/+/- keys.

ROM PCI/ISA BIOS (2A6LGSNC)  
 CHIPSET FEATURES SETUP  
 AWARD SOFTWARE, INC.

|  |   |
|--|---|
| Bank 0/1 DRAM Timing : SDRAM 10ns<br>Bank 2/3 DRAM Timing : SDRAM 10ns<br>Bank 4/5 DRAM Timing : SDRAM 10ns<br>SDRAM Cycle Length : 3<br>DRAM Clock : Host CLK<br>Memory Hole : Disabled<br>Read Around Write : Enabled<br>Concurrent PCI/Host : Disabled<br>System BIOS Cacheable : Disabled<br>Video RAM Cacheable : Disabled<br>AGP Aperture Size : 64M<br>AGP-2X Mode : Disabled<br>OnChip USB1 : Enabled<br>OnChip USB2 : Enabled<br>USB Keyboard Support : Disabled<br>OnChip Sound : Enabled<br>OnChip Modem : Disabled | ESC : Quit            ↑ ↓ → ← : Select Item<br>F1 : Help            PU/PD/+/- : Modify<br>F5 : Old Value (Shift) F2 : Color<br>F7 : Load Setup Defaults |
|--|---|

---

|                                     |  |
|-------------------------------------|--|
| <b>Bank 0/1 2/3 4/5 DRAM Timing</b> | <p>This item allows you to select the value in this field, depending on whether the board has paged DRAMs or EDO (extended data output) DRAMs.</p> <p>The choice:<br/>EDO 50ns,<br/>EDO 60ns,<br/>Slow,<br/>Medium,<br/>Fast,<br/>Turbo</p>  |
| <b>SDRAM Cycle Length</b>           | <p>You can select CAS latency time in HCLKs of 2/2 or 3/3. The system board designer should have set the values in this field, depending on the DRAM installed. Do not change the values in this field unless you change specifications of the installed DRAM or the installed CPU.</p>          |
| <b>DRAM CLOCK</b>                   | <p>The setting of this item must depend on the spec of PC100/PC133. For example, if user chooses HCLK + 33M, that means not only the motherboard but also the SDRAM needs to comply with PC-133 spec.</p> <p>Choice: Host CLK(default), HCLK-33M or HCLK+33M.</p>                                |
| <b>Memory Hole</b>                  | <p>Choose Enabled or Disabled (default). In order to improve performance, certain space in memory can be reserved for ISA cards. This memory must be mapped into the memory's space below 16MB.</p>  |
| <b>Read Around Write</b>            | <p>DRAM optimization feature: If a memory read is addressed to a location whose latest write is being held in a buffer before being written to memory, the read is satisfied through the buffer contents, and the read is not sent to the DRAM.</p> <p>The choice:<br/>Enabled,<br/>Disabled</p> |
| <b>Concurrent PCI / Host</b>        | <p>When disabled, CPU bus will be occupied during the entire PCI operation period.</p> <p>The choice:<br/>Enabled,<br/>Disabled</p>  |
| <b>System BIOS Cacheable</b>        | <p>Choose Enabled or Disabled (default). When Enabled, the access to the system BIOS ROM addressed at F0000H-FFFFFH is cached.</p>   |

|                               |   |
|-------------------------------|---|
| <b>Video RAM Cacheable</b>    | Choose Enabled or Disabled (default). When enabled, the access to the VGA RAM addressed is cached.  |
| <b>AGP Aperture Size (MB)</b> | Choose 4, 8, 16, 32, 64 (default), 128 or 256MB. Memory map and graphics data structures can reside in a Graphics Aperture. This area is like a linear buffer. BIOS will automatically report the starting address of this buffer to the O.S.                 |
| <b>AGP-2X Mode</b>            | This item allows user to enable / disable the AGP-2x (133MHz clock) mode.   |
| <b>OnChip USB1</b>            | This should be enabled if your system has a USB installed on the system board and you wish to use it. Even when so equipped, if you add a higher performance controller, you will need to disable this feature.<br>The choice:<br>Enabled (default), Disabled |
| <b>OnChip USB2</b>            | This should be enabled if your system has a USB installed on the system board and you wish to use it. Even when so equipped, if you add a higher performance controller, you will need to disable this feature.<br>The choice:<br>Enabled (default), Disabled |
| <b>USB Keyboard Support</b>   | Enabled: Enables function when the USB keyboard is being used.<br>Disabled (default): When the AT keyboard is being used.   |
| <b>OnChip Sound</b>           | Enabled (default): Turn on AC'97 Codec chip controller.<br>Disabled: Turn off AC'97 Codec chip controller. If user wants to use external sound card, this function must be disabled.  |
| <b>OnChip Modem</b>           | Enabled (default): Use MC99 feature.<br>Disabled: Turn off MC99 feature. If user wants to use external modem, this function must be disabled.   |

3. Press <ESC> and follow the screen instructions to save or disregard your setting.

## POWER MANAGEMENT SETUP

Power Management Setup changes the system power savings function.

Run the Power Management Setup as follows:

1. Choose "POWER MANAGEMENT SETUP" from the Main Menu and a screen with a list of options will appear.
2. Use one of the arrow keys to move between options and modify the selected options by using PgUp/PgDn/+/- keys.

ROM PCI/ISA BIOS (2A6LJSN9)  
POWER MANAGEMENT SETUP  
AWARD SOFTWARE, INC.

|                     |                  |                          |                       |
|---------------------|------------------|--------------------------|-----------------------|
| ACPI function       | : Disabled       | Primary INTR             | : ON                  |
| Power Management    | : User Define    | IRQ3 (COM 2)             | : Primary             |
| PM Control by APM   | : Yes            | IRQ4 (COM 1)             | : Primary             |
| Video Off After     | : Suspend        | IRQ5 (LPT 2)             | : Primary             |
| Video Off Method    | : V/H SYNC+Blank | IRQ6 (Floppy Disk)       | : Primary             |
| MODEM Use IRQ       | : 3              | IRQ7 (LTP 1)             | : Primary             |
| Soft-Off by PWRBTN  | : Instant-Off    | IRQ8 (RTC Alarm)         | : Disabled            |
| PWRON After PW-Fail | : Former-Sts     | IRQ9 (IRQ2 Redir)        | : Secondary           |
| HDD Power Down      | : Disabled       | IRQ10 (Reserved)         | : Secondary           |
| Doze Mode           | : Disabled       | IRQ11 (Reserved)         | : Secondary           |
| Suspend Mode        | : Disabled       | IRQ12 (PS/2 Mouse)       | : Primary             |
| ** PM Events **     |                  | IRQ13 (Coprprocessor)    | : Primary             |
| VGA                 | : OFF            | IRQ14 (Hard Disk)        | : Primary             |
| LPT & COM           | : LPT/COM        | IRQ15 (Reserved)         | : Disabled            |
| HDD & FDD           | : ON             |                          |                       |
| PCI Master          | : OFF            | ESC : Quit               | ↑ ↓ → ← : Select Item |
| Modem Ring Resume   | : Disabled       | F1 : Help                | PU/PD/+/- : Modify    |
| RTC Alarm Resume    | : Disabled       | F5 : Old Value           | (Shift)F2 : Color     |
|                     |                  | F7 : Load Setup Defaults |                       |



|                             |  |
|-----------------------------|--|
| <b>ACPI Function</b>        | Enabled: Turn on ACPI function.<br>Disabled (default): Turn off ACPI function.   |
| <b>Power Management</b>     | Choose Max. Saving, User Define (default), Disabled, or Min. Saving.   |
| <b>PM Control By APM</b>    | Choose Yes (default) or No. You need to choose Yes when the operating system has the APM functions, otherwise choose No.   |
| <b>Video Off After</b>      | Choose NA, Suspend, Standby (default) or Doze.   |
| <b>Video Off Method</b>     | Choose Blank, DPMS or V/H Sync+Blank (default). You can choose either DPMS or V/H Sync+Blank when the monitor has the Green function. You need to choose Blank when the monitor has neither the Green function.  |
| <b>Modem Use IRQ</b>        | Assign the IRQ number to the modem which is being used so that the ring signal can wake up the system. The default setting is 3 (COM2).  |
| <b>Soft-Off By PWR-BTTN</b> | Instant-Off (default): Turn off the system power at once after pushing the power button.<br>Delay 4 Sec: Turn off the system power 4 seconds after pushing the power button (to meet PC97/98 spec)   |
| <b>PWRON After PW-Fail</b>  | Choose Off (default), On, Former Sts.<br>Off: Disable Power Lost Resume function.<br>On: Enable Power Lost Resume function.<br>Former Sts.: Use former status.<br><div style="border: 1px solid black; padding: 5px; margin-top: 10px;"><b>Note: This function must work with JP8.</b></div> |
| <b>HDD Power Down</b>       | Time is adjustable from 1 to 15 minutes. When the set time has elapsed, the BIOS sends a command to the HDD to power down which turns off the motor.   |

|                          |  |
|--------------------------|--|
| <b>Doze Mode</b>         | This mode sets the CPU speed down to 33MHz.  |
| <b>Suspend Mode</b>      | The option allows you to choose the mode for the different timer. The Suspend mode turns off the CPU and saves the energy of the system.                             |
| <b>VGA</b>               | When On of VGA, any activity from one of the listed system peripheral devices or IRQs wakes up the system.<br>Choice: On(default), Off.                              |
| <b>LPT &amp; COM</b>     | When On of LPT&COM, any activity from one of the listed system peripheral devices or IRQs wakes up the system.<br>Choice: LPT/COM(default), NONE, LPT or COM.        |
| <b>HDD &amp; FDD</b>     | When On of HDD&FDD, any activity from one of the listed system peripheral devices wakes up the system.<br>Choice: On(default), Off.                                  |
| <b>DMA / master</b>      | When On, any activity from one of the listed system peripheral devices wakes up the system.<br>Choice: On, Off(default).   |
| <b>Modem Ring Resume</b> | An input signal on the serial Ring Indicator (RI) Line (in other words, an incoming call on the modem) awakens the system from a soft off state.                     |
| <b>RTC Alarm Rescume</b> | When Enabled, you can set the date and time at the which the RTC(Real Time Clock) alarm awakens the system from suspend mode.<br>Choice: Disabled(default), Enabled. |

|                     |  |
|---------------------|--|
| <b>Primary INTR</b> | When set to On, any event occurring at will awaken a system which has been powered down.<br>On(default): The system can not enter the power saving mode when I/O ports or IRQ# is activated.<br>Off: The system still can enter the power saving mode when I/O ports or IRQ# is activated. |
|---------------------|--|

The following is a list of IRQ's(Interrupt ReQuests), which can be exempted much as the COM ports and LPT ports above can. When an I/O device wants to gain the attention of the operating system, it signals this by causing an IRQ to occur. When the operating system is ready to respond to the request, it interrupts itself and performs the service. When set On, activity will neither prevent the system from going into a power management mode nor awaken it.

- IRQ3 (COM2)**
- IRQ4 (COM1)**
- IRQ5 (LPT2)**
- IRQ6 (Floppy Disk)**
- IRQ7 (LPT1)**
- IRQ8 (RTC Alarm)**

3. Press <ESC> and follow the screen instructions to save or disregard your setting.

## PnP/PCI CONFIGURATION SETUP

PnP/PCI Configuration Setup defines PCI bus slots.

Run the PnP/PCI Configuration Setup as follows:

1. Choose "PnP/PCI CONFIGURATION SETUP" from the Main Menu and a screen with a list of options will appear.
2. Use one of the arrow keys to move between options and modify the selected options by using PgUp/PgDn/+/- keys.

ROM PCI/ISA BIOS (2A6LGSNC)  
PNP/PCI CONFIGURATION  
AWARD SOFTWARE, INC.

|                                     |                                       |
|-------------------------------------|---------------------------------------|
| PNP OS Installed : No               | CPU to PCI Write Buffer : Enabled     |
| Resources Controlled By : Auto      | PCI Dynamic Bursting : Enabled        |
| Reset Configuration Data : Disabled | PCI Master 0 WS Write : Enabled       |
|                                     | PCI Delay Transaction : Enabled       |
|                                     | PCI#2 Access #1 Retry : Disabled      |
|                                     | AGP Master 1 WS Write : Disabled      |
|                                     | AGP Master 1 WS Read : Disabled       |
|                                     | Assign IRQ For USB : Enabled          |
|                                     | Assign IRQ For VGA : Enabled          |
|                                     | ESC : Quit      ↑ ↓ → ← : Select Item |
|                                     | F1 : Help      PU/PD/+/- : Modify     |
|                                     | F5 : Old Value (Shift)F2 : Color      |
|                                     | F7 : Load Setup Defaults              |

**PNP OS Installed**

Yes: OS supportsss Plug and Play function.  
No (default): OS doesn't support Plug and Play function.

**Note: BIOS will automatically disable all PnP resources except the boot device card when you select Yes on Non-PnP O.S.**

**Resources Controlled  
By**

Choose Manual (default) or Auto. The BIOS checks the IRQ/DMA channel number on the ISA and PCI card manually if you choose Manual. And the IRQ/DMA channel number will be checked automatically if you choose Auto.

**Reset Configuration  
Data**

Choose Enabled or Disabled (default). Disable retains Enabled PnP configuration data in BIOS and resets the PnP configuration data in the BIOS.

**CPU to PCI Write Buffer**

Choose Enabled(default) or Disabled.

**PCI Dynamic Bursting**

Choose Enabled(default) or Disabled .

**PCI Master 0 WS Write**

Choose Enabled(default) or Disabled .

**PCI Delay Transaction**

Choose Enabled(default) or Disabled .

**PCI #2 Access #1 Retry**

Choose Enabled or Disabled(default).

**AGP Master 1 WS Write**

Choose Enabled(default) or Disabled.

**AGP Master 1 WS Read**

Choose Enabled or Disabled(default).

---

**Assign IRQ for USB**      Enabled (default): Add one IRQ to USB controller.  
Disabled: Remove IRQ from USB controller. The system will have extra IRQ for other devices but the USB controller will still not be disabled (only IRQ was removed)

---

**Assign IRQ for VGA**      Enabled (default): Add one IRQ to VGA controller.  
Disabled: Remove IRQ from VGA controller. The system will have extra IRQ for other devices but the VGA controller will still not be disabled (only IRQ will be removed)

3. Press <ESC> and follow the screen instructions to save or disregard your setting.

## LOAD SETUP DEFAULTS

Load Setup Defaults option loads the default system values to the system configuration fields. If the CMOS is corrupted the defaults are loaded automatically.

Choose this option and the following message will appear:

“Load Setup Defaults (Y/N)? N”

To use the Setup Defaults, change the prompt to “Y” and press <Enter>.

## CPU SPEED SETTING

CPU Speed Setting option allows user to adjust CPU's settings and retain some informations inside computer when it is working.

Run the Integrated Peripherals as follows:

1. Choose "CPU SPEED SETTING" from the Main Menu and a screen with a list of options will appear.
2. Use one of the arrow keys to move between options and modify the selected options by using PgUp/PgDn/+/- keys.

ROM PCI/ISA BIOS (2A6LGSNC)  
CPU SPEED SETUP  
AWARD SOFTWARE, INC.

|   |   |
|---|---|
| Auto Detect DIMM/PCI Clk : Disabled<br>Spread Spectrum : Disabled<br>CPU Host Clock(CPU/PCI) : Default<br>Current CPU Temp. :<br>Current System Temp. :<br>Current CPUFAN1 Speed :<br>Current CPUFAN2 Speed :<br>Vcore : 2.5V :<br>3.3V : 5V :<br>12V : | ESC : Quit      ↑↓→← : Select Item<br>F1 : Help      PU/PD/+/- : Modify<br>F5 : Old Value (Shift)F2 : Color<br>F7 : Load Setup Defaults |
|---|---|



|                                      |   |
|--------------------------------------|---|
| <b>Auto Detect DIMM/PCI<br/>clk</b>  | Choose Disabled (default) or Enabled. The clock generator will turn off the DIMM clock if this slot is empty.                 |
| <b>Spread Spectrum</b>               | Choose Disabled (default) or Enabled. This function is designed to EMI test only.   |
| <b>CPU Host Clock (CPU/<br/>PCI)</b> | Select the CPU Host Clock.<br>The choice: default, 66/33MHz, 75/37MHz, 83/41MHz, 124/31MHz, 133/33MHz, 140/35MHz, 150/37MHz.  |
| <b>Current CPU Temp.</b>             | Shows temperature of the CPU.   |
| <b>Current System Temp.</b>          | Shows the temperature of the system.  |
| <b>Current CPUFAN1<br/>Speed</b>     | Shows current speed of the FAN. The fan must provide rotary pulse. (Normally these types of fan have a three-wire connector.) |
| <b>Current CPUFAN2<br/>Speed</b>     | Shows current speed of the FAN. The fan must provide rotary pulse. (Normally these types of fan have a three-wire connector.) |
| <b>Voltage</b>                       | Shows power supply actual voltage value.  |

3. Press <ESC> and follow the screen instructions to save or disregard your setting.

## INTEGRATED PERIPHERALS

Integrated Peripherals option changes the values of the chipset registers. These registers control system options in the computer.

Run the Integrated Peripherals as follows:

1. Choose "INTEGRATED PERIPHERALS" from the Main Menu and a screen with a list of options will appear.
2. Use one of the arrow keys to move between options and modify the selected options by using PgUp/PgDn/+/- keys.

ROM PCI/ISA BIOS (2A6LGSNC)  
INTEGRATED PERIPHERALS  
AWARD SOFTWARE, INC.

|                                   |                                       |
|-----------------------------------|---------------------------------------|
| OnChip IDE Channel0 : Enabled     | Onboard Parallel Port : 378/IRQ7      |
| OnChip IDE Channel1 : Enabled     | Onboard Parallel Mode : ECP/EPP       |
| IDE Prefetch Mode : Enabled       | ECP Mode Use DMA : 3                  |
| Primary Master PIO : Auto         | Onboard Legacy Audio : Enabled        |
| Primary Slave PIO : Auto          | Sound Blaster : Disabled              |
| Secondary Master PIO : Auto       | SB I/O base Address : 220H            |
| Secondary Slave PIO : Auto        | SB IRQ Select : IRQ 5                 |
| Primary Master UDMA : Auto        | SB DMA Select : DMA 1                 |
| Primary Slave UDMA : Auto         | MPU-401 : Disabled                    |
| Secondary MasterUDMA : Auto       | MPU-401 I/O Address : 330H - 333H     |
| Secondary Slave UDMA : Auto       | Game Port(200H - 207H) : Enabled      |
| Init Display First : PCI Slot     |                                       |
| Onboard FDD Controller : Enabled  |                                       |
| Onboard Serial Port 1 : 3F8/IRQ4  |                                       |
| Onboard Serial Port 2 : 2F8/IRQ3  |                                       |
| UART 2 Mode : Standard            | ESC : Quit      ↑ ↓ → ← : Select Item |
| IR Function Duplex : Half         | F1 : Help      PU/PD/+/- : Modify     |
| TX, RX inverting enable : No, Yes | F5 : Old Value (Shift)F2 : Color      |
|                                   | F7 : Load Setup Defaults              |

|  |  |
|--|--|
| <b>OnChip IDE Channel</b><br>0 / 1                                       | <hr/> <p>The chipset contains a PCI IDE interface with support from two IDE channels. Select Enabled to activate the first and/or the second IDE interface. Select Disabled to deactivate an interface, if you install a primary and/or second add-on IDE interface.<br/>The choice: Enabled(default), Disabled.</p> <hr/> |
| <b>IDE Prefetch Mode</b>   | <hr/> <p>Choose Enable(default), Disabled.</p> <hr/>   |
| <b>Primary<br/>Master/Slave PIO<br/>Secondary<br/>Master/Slave PIO</b>   | <hr/> <p>Choose Auto (default) or Mode 0~4. The BIOS will detect the HDD mode type automatically when you choose Auto. You need to set to a lower mode than Auto when your hard disk becomes unstable.</p> <hr/>   |
| <b>Primary Master/Slave<br/>UDMA<br/>Secondary Master/Slave<br/>UDMA</b> | <hr/> <p>Enabled (default): Turn on the onboard IDE function.<br/>Disabled: Turn off the onboard IDE function.</p> <hr/>   |
| <b>Init Display First</b>  | <hr/> <p>This option allows you to decide to activate PCI Slot or AGP first.<br/>Choose PCI Slot(default), AGP.</p> <hr/>  |
| <b>Onboard FDC<br/>Controller</b>  | <hr/> <p>Choose Enabled (default) or Disabled. Choose Disabled when you use an ISA card with FDD function, or choose Enabled to use the onboard FDD connector.</p> <hr/>   |
| <b>Onboard Serial Port1</b>  | <hr/> <p>Choose Auto (default), 3F8/IRQ4, 2F8/IRQ3, 3E8/IRQ4, 2E8/IRQ3 or Disabled. Don't set port 1 &amp; 2 to the same value, except when setting at Disabled.</p> <hr/>   |
| <b>Onboard Serial Port2</b>  | <hr/> <p>Choose Auto (default), 3F8/IRQ4, 2F8/IRQ3, 3E8/IRQ4, 2E8/IRQ3 or Disabled.</p> <hr/>  |

---

|                                 |   |
|---------------------------------|---|
| <b>UART 2 Mode</b>              | Choose Standard (default), HPSIR or ASKIR.  |
| <b>IR Function Duplex</b>       | The choice: Half (default), Full  |
| <b>TX, RX inverting enabled</b> | Choose No, Yes (default) / No, No / Yes, No / Yes, Yes.<br><div style="border: 1px solid black; padding: 5px; margin-top: 10px;"><b>Note: The above 2 options won't work unless UART2 Mode HPSIR/ASKIR is selected.</b></div>   |
| <b>Onboard Paralle Port</b>     | Choose the printer I/O address: 378H/IRQ7 (default), 3BCH/IRQ7, 278H/IRQ5 or Disabled.  |
| <b>Onboard Parallel Mode</b>    | Choose Normal (default), ECP/EPP, SPP mode. The mode depends on the external device connected to this port.   |
| <b>ECP Mode Use DMA</b>         | Choose DMA3 (default) or DMA1. Most sound cards use DMA1. Check with your sound card configuration to make sure that there is no conflict with this function.<br><div style="border: 1px solid black; padding: 5px; margin-top: 10px;"><b>Note: This option will not be displayed unless the EPP/ECP is selected.</b></div> |
| <b>EPP Mode Select</b>          | Choose EPP1.7 (default) or EPP1.9. EPP1.9 supports hardware handshake. This setting is dependent upon your EPP device.<br><div style="border: 1px solid black; padding: 5px; margin-top: 10px;"><b>Note: The above 2 options will not be displayed unless the EPP/ECP is selected.</b></div>                                |
| <b>Onboard Legacy Audio</b>     | The choice: Enabled (default), Disabled.  |

|                             |   |
|-----------------------------|---|
| <b>Sound Blaster</b>        | Choose Enabled or Disabled (default). For DOS mode compatibility, this option must be enabled. In Windows system, this option must be disabled. |
| <b>SB I/O Base Address</b>  | Use default setting.  |
| <b>SB IRQ Select</b>        | Use default setting.  |
| <b>SB DMA Select</b>        | Use default setting.  |
| <b>MPU-401</b>              | Choose Enabled or Disabled (default). Some feedback type joystick must enable this option (ex: Sidewinder joystick).                            |
| <b>MPU-401 I/O Address</b>  | Use default setting.  |
| <b>Game Port (200-207H)</b> | Use default setting.  |

3. Press <ESC> and follow the screen instructions to save or disregard your setting.

## SUPERVISOR/USER PASSWORD

These two options allow you to set your system passwords. Normally, the supervisor has a higher ability to change the CMOS setup option than the user. The way to set up the passwords for both supervisor and user are as follows:

1. Choose "CHANGE PASSWORD" from the Main Menu and press <Enter>. The following message appears:

"Enter Password:"

2. The first time you run this option, enter your own password up to 8 characters and press <Enter>. The screen doesn't display the entered characters.
3. After you entered the password, the following message appears prompting you to confirm the password:

"Confirm Password:"

4. Enter the same password "exactly" as you just typed again to confirm the password and press <Enter>.
5. Move the cursor to Save & Exit Setup to save the password.
6. If you need to delete the password you entered before, choose the Supervisor Password and press <Enter>. It will delete the password that you had before.
7. Move the cursor to Save & Exit Setup to save the option you did, otherwise the old password will still be there the next time you turn your machine on.
8. Press <ESC> to exit to the Main Menu.

**Note: If you forget or lose the password, the only way to access the system is to clear the CMOS RAM by setting JBAT1. All setup information will be lost and back to default setting. You need to run the BIOS setup program and re-define all settings again.**

## IDE HDD AUTO DETECTION

IDE HDD Auto Detection detects the parameters of an IDE Hard Disk drive and automatically enters them to the Standard CMOS Setup screen.

The screen will ask you to select a specific Hard Disk for Primary Master after you selected this option. If you accept a Hard Disk detected by the BIOS, you can enter “Y” to confirm and then press <Enter> to check next Hard Disk. This function allows you to check four Hard Disks and you may press the <ESC> after the <Enter> to skip this function and go back to the Main Menu.

## SAVE & EXIT SETUP

Save & Exit Setup allows you to save all modifications you have specified into the CMOS memory. Highlight this option on the Main Menu and the following message appears:

SAVE to CMOS and EXIT (Y/N)? Y

Press <Enter> key to save the configuration changes.

## EXIT WITHOUT SAVING

Exit Without Saving allows you to exit the Setup utility without saving the modifications that you have specified. Highlight this option on the Main Menu and following message appears:

Quit Without Saving (Y/N)? N

You may change the prompt to “Y” and press the <Enter> key to leave this option.

## **APPENDIX A**

### **FLASH MEMORY UPDATE INSTALLATION**

1. Download BIOS files and flash utility from your board vendor. They are: awdfash.exe and .bin file.
2. Copy them to bootable diskette and boot from diskette.
3. The diskette cannot include memory manager e.g. emm386.exe, qemm and himem.sys, otherwise there will appear an error message "insufficient memory".
4. Type "awdfash filename(XXXX.bin)".
5. Next screen will ask you save current bios to file or not? Depend on your diskette capacity, choose Y or N for this option.
6. Then screen ask you programming the flash memory now? type Y for this option.
7. Programming finish, utility will ask you reboot system.
8. Reset system and press DEL key enter bios setup screen.
9. Select LOAD SETUP DEFAULTS, press ENTER, press Y, press F10, press Y
10. Finish update procedure.



## APPENDIX B DRIVER INSTALLATION

If you are using **Windows 98 SE**, you do not need to install the **4-in-1 driver** as the **IRQ Routing Driver** and the **ACPI Registry** are already incorporated into the operating system. Users with **Windows 98 SE** may update the **IDE Busmaster** and **AGP drivers** by installing them individually.

### PART 1:

1. Put the CD into your CD-ROM.
2. There appears a welcome window.  
(If doesn't, it means that your CD-ROM auto-run function does not enable, but you still can browser the CD via Windows Explorer and change the directory to where your CD-ROM directory is. Then run the **autorun.exe**)
3. Select "**Install Driver**".
4. Select "**Install VIA Chipsets Driver**".
5. Select "**Install 4in1 Driver**".
6. Then the program will automatically setup all drivers your system needs.
7. Finally, the system will re-boot.

**NOTE: AFTER INSTALLED "4in1 Driver", USER DOESN'T NEED TO INSTALL ANY OTHER PROGRAM IN PART 2.**

### PART 2:

**CAUTION!! ALL THE VIA MAINBOARD MUST INSTALL FOLLOWING 3 DRIVERS!!!**

#### VIA Patch Code Installation

##### **Windows95/Windows98:**

1. Go to the CD-ROM disk, we suggest the CD-ROM title is D:\.
2. Find and run D:\Patch\Via\patch9x\Setup\Setup.exe
3. Select "Install VIA Chipset Functions' Registry", then it will automatically install this program.

**Note!** This program should be installed before any other VIA's drivers.

#### VIA AGP VxD Driver for Windows 9x Installation

##### **Windows95/Windows98:**

1. Go to the CD-ROM disk, we suggest the CD-ROM title is D:\.
2. Find and run D:\Driver\Via\Agp\Setup\Setup.exe
3. Select "Install VIA AGP VxD in turbo mode" or "Install VIA AGP VxD normal mode", then it will automatically install this program.

## VIA PCI IRQ Routing Miniport for Windows 9x Installation

### **Windows95/Windows98:**

1. Go to the CD-ROM disk, we suggest the CD-ROM title is D:\.
2. Find and run D:\Patch\Via\Virq9x\Setup.exe

**Note:** Before install Windows98, user must enable two functions for this miniport driver in the BIOS menu, one is “*OnChip USB*” in the “**Chipset Features Setup**” and another is “*Assign IRQ for USB*” in the “**PNP/PCI Configuration Setup**”.

## VIA Hardware Monitor Setup

1. Make sure that the CD is in the CD-ROM.
2. There will appear a welcome window, please use the mouse to choose “**Install Driver**” item.  
(If not, that means user’s CD-ROM autorun function is disabled, but user could still install the program via Windows Explorer. )
3. Choose “**Install VIA Chipset Driver**” item, then choose “**Install VIA Hardware Monitor**” item.
4. The setup program will install Hardware Monitor software automatically.