



# **SY-7ISA+**

# **Motherboard**

\*\*\*\*\*

Socket 370 Celeron™ Processor supported

815E AGP/PCI/CNR

66/100/133 MHz Front Side Bus supported

ATX Form Factor

\*\*\*\*\*

## **User's Manual**

Copyright © 2000 by Soyo Computer Inc.

**Trademarks:**

Soyo is the registered trademark of Soyo Computer Inc. All trademarks are the properties of their owners.

**Product Rights:**

All names of the product and corporate mentioned in this publication are used for identification purposes only. The registered trademarks and copyrights belong to their respective companies.

**Copyright Notice:**

All rights reserved. This manual has been copyrighted by Soyo Computer Inc. No part of this manual may be reproduced, transmitted, transcribed, translated into any other language, or stored in a retrieval system, in any form or by any means, such as by electronic, mechanical, magnetic, optical, chemical, manual or otherwise, without permission in writing from Soyo Computer Inc.

**Disclaimer:**

Soyo Computer Inc. makes no representations or warranties regarding the contents of this manual. We reserve the right to amend the manual or revise the specifications of the product described in it from time to time without obligation to notify any person of such revision or amend. The information contained in this manual is provided to our customers for general use. Customers should be aware that the personal computer field is subject to many patents. All of our customers should ensure that their use of our products does not infringe upon any patents. It is the policy of Soyo Computer Inc. to respect the valid patent rights of third parties and not to infringe upon or to cause others to infringe upon such rights.

**Restricted Rights Legend:**

Use, duplication, or disclosure by the Government is subject to restrictions set forth in subparagraph (c)(1)(ii) of the Rights in Technical Data and Computer Software clause at 252.277-7013.

**About This Guide:**

This Quick Start Guide can help system manufacturers and end users in setting up and installing the Motherboard. Information in this guide has been carefully checked for reliability; however, to the correctness of the contents there is no guarantee given. The information in this document is subject to amend without notice.

For further information, please visit our **Web Site** on the Internet. The address is "<http://www.soyo.com.tw>".

**Edition: October 2000****Version 1.0****7ISA+ SERIAL**

**FC** Tested To Comply  
With FCC Standards  
FOR HOME OR OFFICE USE

**100%** POST CONSUMER  
RECYCLED PAPER

# Table of Contents

CHAPTER 1 MOTHERBOARD DESCRIPTION .....	1
1-1    INTRODUCTION .....	1
1-2    HANDLING THE MOTHERBOARD .....	3
1-3    ELECTROSTATIC DISCHARGE PRECAUTIONS .....	3
1-4    SY-7ISA+ MOTHERBOARD LAYOUT .....	4
1-5    SY-7ISA+ MOTHERBOARD COMPONENTS .....	5
1-6    CHIPSET .....	7
1-7    I/O INTERFACE CONTROLLER .....	14
1-8    HARDWARE MONITOR.....	16
1-9    WAKE ON LAN TECHNOLOGY.....	16
CHAPTER 2 HARDWARE INSTALLATION .....	17
2-1    PREPARATIONS .....	17
2-2    UNPACKING THE MOTHERBOARD .....	18
2-3    INSTALLATION GUIDE .....	19
2-3.1    CPU Installation.....	20
2-3.2    SDRAM Memory Module Installation.....	23
2-3.3    Motherboard Connector.....	25
2-3.4    Jumper Setting.....	41
2-3.5    Voice Doctor.....	44
2-3.6    CMOS Clear (JP5).....	44
2-3.7    Power On .....	45
2-3.8    Quick BIOS Setup .....	46
2-3.9    Troubleshooting at First Start.....	48
2-3.10    Power Off.....	52
CHAPTER 3 BIOS SETUP UTILITY .....	53
3-1    SOYO COMBO SETUP .....	56
3-2    STANDARD CMOS SETUP .....	60
3-3    ADVANCED BIOS FEATURES.....	63
3-4    ADVANCED CHIPSET FEATURES.....	67

---

3-5	INTEGRATED PERIPHERALS .....	69
3-6	POWER MANAGEMENT SETUP .....	74
3-7	PNP/PCI CONFIGURATION SETUP.....	78
3-8	PC HEALTH STATUS.....	81
3-9	LOAD FAIL-SAFE DEFAULTS.....	83
3-10	LOAD OPTIMIZED DEFAULTS.....	84
3-11	SUPERVISOR PASSWORD.....	85
3-12	USER PASSWORD.....	86
3-13	IDE HDD AUTO DETECTION .....	87
CHAPTER 4 DRIVERS INSTALLATION .....		89
CHAPTER 5 SIGMATEL AUDIO DRIVER INSTALLATION.....		93
CHAPTER 6 INTEL 815 VGA DRIVERS INSTALLATION.....		95

## Chapter 1

# MOTHEBOARD DESCRIPTION

### 1-1 INTRODUCTION

- The **SY-7ISA+** AGP/PCI/CNR Motherboard is a high-performance Socket 370 processor supported Micro ATX form-factor system board. **SY-7ISA+** uses the 815E Chipset technology and supports Socket 370 processors. This Motherboard is fully compatible with industry standards Supports Intel®FC-PGA processors
  - FSB 66MHz: Celeron™(400-700MHz)
  - FSB 100MHz: Pentium® III (500-850MHz)
  - FSB 133MHz: Pentium® III (533MHz-1.13GHz)
- Supports 66/100/133 MHz Front Side Bus Frequency
- Auto-detect CPU voltage
- PC99, ACPI
- Ultra DMA33/66/100 (ATA 33/66/100)
- Supports Wake-On-LAN (WOL)
- Support PC-100 and PC-133 SDRAM
- Supports ACPI Suspend Indicator
- Power-on by modem, alarm and PS/2 Keyboard
- Power failure resume
- Supports Suspend to RAM
- Supports onboard hardware monitoring and includes Hardware Doctor™utility
- Fan speed control
- Easy CPU settings in BIOS with the “SOYO COMBO Setup”
- Support display cache interface (AIMM card) multiplexed on the AGP interface
  - 133MHz SDRAM interface only
  - 4MB max addressable

- Battery Low voltage Detect
- Supports multiple-boot function
- AGP 2.0 Compliant;  
AGP Universal Connector supports:
  - 1.5V and 3.3V AGP cards
  - 1X/2X/4X data transfer
- Supports Communication Networking Riser Slot (CNR 1.0 compliant) \*
- Smart Card Reader
  - Compliant with Personal Computer Smart Card PC/SC Working Group standard
  - Compliant with smart card ISO 7816 protocols
  - Supports card present detect
  - Supports Smart Card insertion power-on feature
- 3 x DIMM slots for SDRAM memory
- 1 x 32-bit AGP slot
- 6 x 32-bit bus master PCI slots
- 4 x USB ports onboard
- 1 x IrDA port
- ATX power connector



\* If the user wants to use a Modem Riser card (MR) make sure to use a **Secondary** mode MR, **PRIMARY** mode MRs are **NOT** Supported.

## 1-2 HANDLING THE MOTHERBOARD

To avoid damage to your Motherboard, follow these simple rules while unpacking:

- Before handling the Motherboard, ground yourself by grasping an unpainted portion of the system's metal chassis.
- Remove the Motherboard from its anti-static packaging. Hold the Motherboard by the edges and avoid touching its components.
- Check the Motherboard for damage. If any chip appears loose, press carefully to seat it firmly in its socket.



---

**Warning:** Do not apply power if the Motherboard appears damaged. If there is damage to the board, contact your dealer immediately.

---

## 1-3 ELECTROSTATIC DISCHARGE PRECAUTIONS

Make sure to ground yourself before handling the Motherboard or other system components. Electrostatic discharge can easily damage the components. Note that you must take special precautions when handling the Motherboard in dry or air-conditioned environment.

To protect your equipment from electrostatic discharge, take the following precautions:

- Do not remove the anti-static packaging until you are ready to install.
- Ground yourself before removing any system component from its protective anti-static packaging. (To ground yourself, grasp the expansion slot covers or other unpainted portions of the computer chassis.)
- Frequently ground yourself while working or use a grounding strap.
- Handle the Motherboard by its edges and avoid touching its components.

# 1-4 SY-7ISA+ MOTHERBOARD LAYOUT

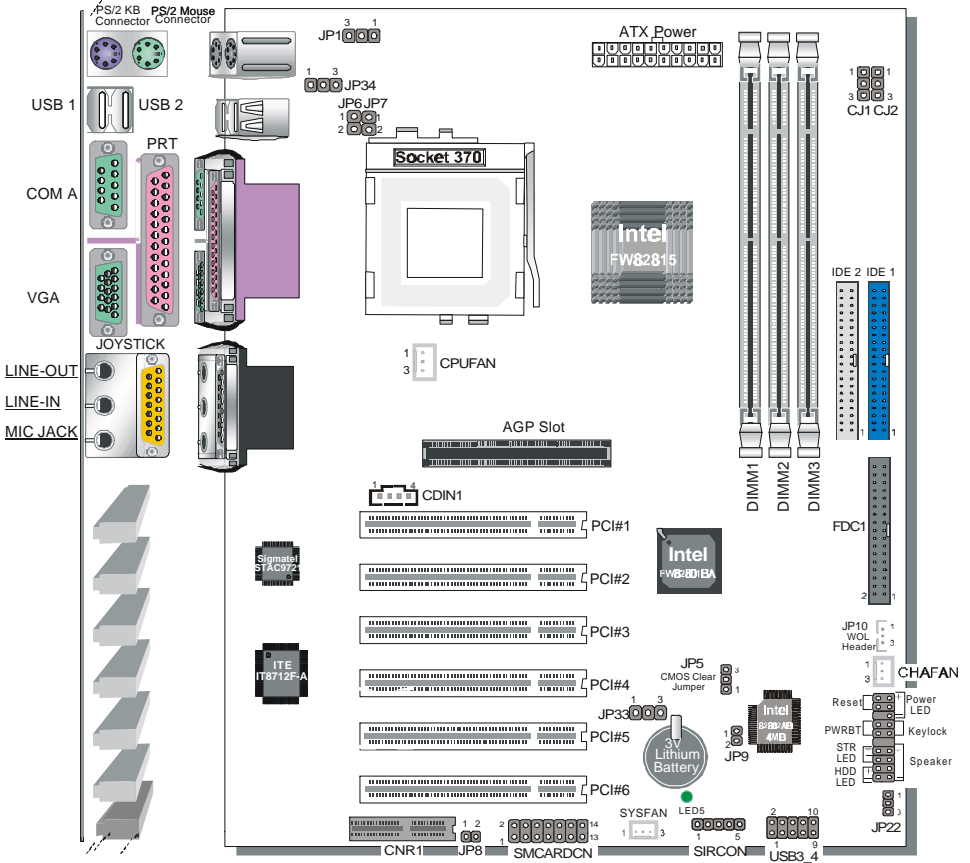

Back Panel

SY-7ISA+ Platform



## 1-5 SY-7ISA+ MOTHERBOARD COMPONENTS

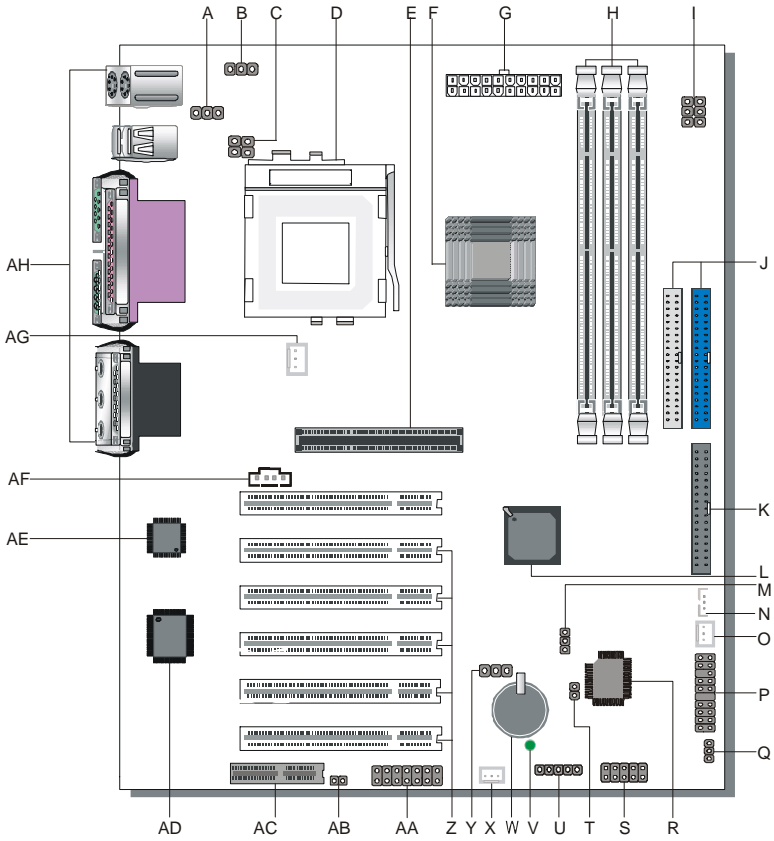

- A Enable/Disable USB Keyboard Wake Up Jumper**
- B Enable/Disable Power-On by Keyboard Jumper**
- C CPU Frequency Settings Jumper**
- D Socket 370 Connector**
- E 32-bit AGP slot**
- F Intel FW82815 Chip**
- G ATX Power Supply Connector**
- H DIMM Bank**
- I CPU Frequency Settings Jumper**
- J Bus Mastering E-IDE/ATAPI Ports**
- K Floppy Disk Drive (FDD)**
- L Intel FW82801 Chip**
- M CMOS Clear Jumper**
- N Wake-On-LAN( WOL) Header**
- O Chassis Cooling Fan Connector**
- P Front panel connectors**
- Q SPEAKER OPTION Setting Jumper**
- R Intel 82802AB 4MB FWH**
- S USB Connector**
- T FWH Boot Block Write-Protect Setting Jumper**
- U Serial Infrared (IrDA) Device Header**
- V 5V Stand-by indicator LED (LED 5)**
- W 3V Lithium Battery**
- X System Fan Connector**
- Y Voice Doctor's language Jumper**
- Z 32-bit PCI Mastering Slots**
- AA Smart Card Reader Connector**
- AB CNR MR Card-CODEC OPTION Setting Jumper**
- AC Communication Networking Riser Slot**
- AD ITE IT8712F-A Chip**
- AE AC97 Codec Chip**
- AF CPU Cooling Fan Connector**
- AG CD-IN Connector**
- AH Back panel Connectors**

## **1-6 CHIPSET**

The Intel ® 815E Chipset is a high-flexibility chipset designed to extend from the basic graphics/multimedia PC platform up to the mainstream performance desktop platform. The chipset consists of a Graphics and Memory Controller Hub (Intel ® 815E GMCH), an I/O Controller Hub2 (ICH2) for the I/O subsystem, and a Firmware Hub(FWH). The Intel ® 815E GMCH integrates a system memory SDRAM controller that supports a 64-bit 100/133 MHz SDRAM array.

The Intel ® 815E GMCH integrates a Display Cache SDRAM controller that supports a 32-bit 133MHz SDRAM array for enhanced integrated 2D and 3D graphics performance. Multiplexed with the display cache interface is an AGP controller interface to enable graphics configuration and upgrade flexibility with the Intel ® 815E chipset. The AGP interface and the internal graphics device are mutually exclusive. When the AGP port is populated with an AGP graphics card the integrated graphics is disabled and thus the display cache interface is not needed.

### **1-6.1 The Intel® 815E Chipset System**

The Intel ® 815E Chipset uses a hub architecture with the Intel ® 815E GMCH as the host bridge hub and the 82801BA I/O Controller Hub2(ICH2) as the I/O hub. The ICH2 is a highly integrated multifunctional I/O Controller Hub that provides the interface to the PCI Bus and integrates many of the functions needed in today's PC platforms. The Intel ® 815E GMCH and ICH2 communicate over a dedicated hub interface.

82801BA(ICH2) functions and capabilities include:

- PCI Rev2.2 compliant with support for 33MHz PCI operations
- ICH2 supports up to 6 PCI/Req/Gnt pairs
- Integrated System Management Controller

- Enhanced DMA Controller, Interrupt Controller & Timer Functions
- Bus Master IDE controller – Supports Ultra ATA/100
- USB host interface with support for 4 USB ports
- AC'97 2.1 interface
- Low Pin Count (LPC) interface
- Firmware Hub(FWH)interface support
- Alert On LAN
- SIM Bus controller
- I/O APIC
- Upstream accelerated hub architecture interface for access to the GMCH

### 1-6.2 Intel® 815E GMCH Overview

The Intel® 815E GMCH functions and capabilities include:

- Support Uni-processor system
- 64-bit AGTL+ based System Bus Interface at 66/100/133 MHz
- 32-bit Host Address Support
- 64-bit System Memory Interface with optimized support for SDRAM at 100/133 MHz
- Integrated 2D & 3D Graphics Engines
- Integrated H/W Motion Compensation Engine
- Integrated 230 MH DAC
- Integrated Digital Video Out Port
- 133MHz Display Cache
- AGP 1X/2X/4X Controller

### 1-6.3 Host Interface

The host interface of the Intel® 815E GMCH is optimized to support the Intel® Pentium III processor and Intel® Celeron™ Processor in the FCPGA package. The Intel® 815E GMCH implements the host address, control, and data bus interfaces within a single device. The Intel® 815E GMCH supports a 4-deep in-order queue(i.e., supports pipelining of up to 4 outstanding transaction

requests on the host bus). Host bus addresses are decoded by the Intel® 815E GMCH for accesses to system memory, PCI memory and PCI I/O (via hub interface), PCI configuration space and Graphics memory. The Intel® 815E GMCH takes advantage of the pipelined addressing capability of the pipelined addressing capability of the processor to improve the overall system performance.

The Intel® 815E GMCH supports the 370-pin socket processor. \*370-pin socket (PGA370). The PGA370 is a zero insertion force (ZIF) socket that a processor in the FCPGA package will use to interface with a system board.

#### **1-6.4 System Memory Interface**

The Intel® 815E GMCH integrates a system memory controller that supports a 64-bit 100/133 MHz SDRAM array. The only DRAM type supported is industry standard Synchronous DRAM (SDRAM). The SDRAM controller interface is fully configurable through a set of control registers.

The Intel® 815E GMCH supports industry standard 64-bit wide DIMMs with SDRAM devices. The thirteen multiplexed address lines. SMAA[12:0], along with the two bank select lines, SBS[1:0], allow the Intel® 815E GMCH to support 2M, 4M, 8M, 16M, and 42M x64 DIMM. Only asymmetric addressing is supported. The Intel® 815E GMCH has 6 SCS# lines (2 copies of each for electrical loading), enabling the support of up to six 64-bit rows of SDRAM. The Intel® 815E GMCH targets SDRAM with CL2 and CL3 and supports both single and double-sided DIMMs. Additionally, the Intel® 815E GMCH also provides a 1024 deep refresh queue. The Intel® 815E GMCH can be configured to keep up to 4 page op[en within the memory array. Pages can be kept open in any one bank of memory.

SCKE[4:0] is used in configurations requiring powerdown mode for the SDRAM.

## 1-6.5 Multiplexed AGP and Display Cache Interface

The Intel® 815E GMCH multiplexes an AGP interface with a display cache interface for internal 3D graphics performance improvement. The Display Cache is used only in the internal graphics. When an AGP card is installed in the system, the Intel® 815E GMCH internal graphics will be disabled and the AGP controller will be enabled.

### 1-6.5.1 AGP Interface

A single AGP connector is supported by the Intel® 815E GMCH AGP interface. The AGP buffers operate in one of two selectable modes in order to support the AGP Universal Connector:

- 1) 3.3V drive, not 5 volt safe – This mode is compliant to the AGP 1.0 and 2.0 specs.
- 2) 1.5V drive, not 3.3 volt safe – This mode is compliant with the AGP 2.0 spec.

The following table shows the AGP Data Rate and the Signaling Levels supported by the GMCH:

	Signaling Level	
Data Rate	1.5V	3.3V
1x AGP	Yes	Yes
2x AGP	Yes	Yes
3x AGP	Yes	No

The AGP interface supports 4x AGP signaling. AGP semantic (PIPE# or SBA[7:0]) cycles to SDRAM are not snooped on the host bus. AGP FRAME# cycles to SDRAM are snooped on the host bus. The GMCH supports PIPE# or SBA[7:0] AGP address mechanisms, but not both simultaneously. Either the PIPE# or the SBA[7:0] mechanism must be selected during system initialization. High priority accesses are supported. Only memory writes from the hub interface to AGP are allowed. No transactions from AGP to the hub

interface are allowed.

### **1-6.5.2 AIMM Card Interface**

Display Cache Interface multiplexed on the AGP interface:

- 32-bit data interface
- 133 MHz SDRAM interface only
- Flexible AGP In-Line Memory Module (AIMM)

Implementation

- Support for 2 1Mx16, or 1 2Mx32 on AIMM card
- 4MB max addressable

### **1-6.5.3 Display Cache Interface**

The Intel® 815E GMCH support a Display Cache SDRAM controller with a 32-bit 133 MHz SDRAM array. The DRAM type supported is industry standard Synchronous DRAM (SDRAM) like that of the system memory. The local memory SDRAM controller interface is fully configurable through a set of control registers.

### **1-6.6 Hub Interface**

The hub interface is a private interconnect between the Intel® 815E GMCH and the ICH2.

### **1-6.7 Intel® 815E GMCH Integrate Graphics Support**

The Intel® 815E GMCH includes a highly integrated graphics accelerator. Its architecture consists of dedicated multi-media engines executing in parallel to deliver high performance 3D, 2D and motion compensation video capabilities. The 3D and 2D engines are managed by a 3D/2D pipeline preprocessor allowing a sustained flow of graphics data to be rendered and displayed. The deeply pipelined 3D accelerator engine provides 3D graphics quality and performance via per-pixel 3D rendering and parallel data paths which allow each pipeline stage to simultaneously operate on different primitives or portions of the same primitive. The Intel® 815E GMCH graphics accelerator engine supports perspective-correct texture mapping, trilinear and anisotropic Mip-Map filtering, Gouraud shading, alpha-blending, fogging and Z-buffering. A rich

set of 3D instructions permit these features to be independently enabled or disabled.

For the Intel® 815E GMCH, a Display Cache (DC) can be used for the Z-buffer is located in system memory.

The Intel® 815E GMCH integrated graphics accelerator's 2D capabilities include BLT and arithmetic STRBLT engines, a hardware cursor and an extensive set of 2D registers and instructions. The high performance 64-bit BitBLT engine provides hardware acceleration for many common Windows operations.

In addition to its 2D/3D capabilities, the Intel® 815E GMCH integrated graphics accelerator also supports full MPEG-2 motion compensation for software-assisted DVD video playback.



### 1-6.8 IDE Support

The motherboard has two independent bus-mastering PCI IDE interfaces. These interfaces support PIO Mode 3, PIO Mode 4, PIO Mode 5 ATAPI devices (e.g., CD-ROM), and Ultra DMA 33/66/100 synchronous-DMA mode transfers. The BIOS supports logical block addressing (LBA) and extended cylinder head sector (ECHS) translation modes. The BIOS automatically detects the IDE device transfer rate and translation mode. Programmed I/O operations usually require a substantial amount of processor bandwidth. However, in multitasking operating systems, the bandwidth freed by bus mastering IDE can be devoted to other tasks while disk transfers are occurring.

The motherboard also supports laser servo (LS-120) drives. LS-120 technology allows the user to perform read/write operations to LS-120 (120MB) and conventional 1.44MB and 720KB diskettes. An optical servo system is used to precisely position a dual-gap head to access the diskett's 2,490 tracks per inch (tpi) containing up to 120 MB of data storage. A conventional diskette uses 135 tpi for 1.44 MB of data storage. LS-120 drivers are ATAPI-compatible and connect to the motherboard's IDE interface. (LS-120 drives are also available with SCJSI and parallel port interfaces.) Some versions of Windows 95 and Windows NT operating systems recognize the LS-120 drive as a bootable device in both 120 MB and 1.44 MB mode.

Connection of an LS-120 drive and a standard 3.5-inch diskette drive is allowed. The LS-120 drive can be configured as a boot device if selected as Drive A in the BIOS setup program.

#### *Note*

*If you connect at LS-120 drive to an IDE connector and configure it as the :boot: drive and configure a standard 3.5-inch diskette drive as a "B" drive, the standard diskette drive is not seen by the operating system. When the LS-120 drive is configured as the "boot: device, the system will recognize it as both the A and B drive*

### **1-6.9 Real-Time Clock**

The real-time clock supports 256 bytes of battery-backed CMOS SRAM. Hardware implementation to indicate century rollover.

## **1-7 I/O INTERFACE CONTROLLER**

The motherboard uses the ITE IT8712F-A I/O controller which features:

- Single diskette drive interface
- Two serial ports
- FIFO supports on both serial and diskette interfaces
- One parallel port with Extended Capabilities Port (ECP) and Enhanced Parallel Port (EPP) support
- PS/2 style mouse and keyboard interfaces
- PCI PME interface
- Intelligent auto power management, including:
  - Shadowed write-only registers for ACPI compliance
  - Programmable wake-up event interface

The Setup program provides configuration option for the I/O controller.

### **1-7.1 Serial Ports**

The motherboard has one 9-pin D-Sub serial port connector located on the back panel. The NS16C5450-compatible UARTs support data transfers at speeds up to 115.2 Kbits/sec with BIOS support.

### **1-7.2 Parallel Port**

The connector for the multimode bi-directional parallel port is a 25-pin D-Sub connector located on the back panel of the motherboard. In the Setup program, there are four options for parallel port operation:

- Compatible (standard mode)
- Bi-directional (PS/2 compatible)
- Bi-directional EPP. A driver from the peripheral manufacturer is required for operation. See Section 6.2 for EPP compatibility.
- Bi-directional high-speed ECP

### **1-7.3 Diskette Drive Controller**

The I/O controller is software compatible with the 82077 diskette drive controller and supports both PC-AT and PS/2 modes. In the Setup

---

program, the diskette drive interface can be configured for the following diskette drive capacities and sizes.

- 360 KB, 5.25-inch
- 1.2 MB, 5.25-inch
- 720 KB, 3.5-inch
- 1.2 MB, 3.5-inch (driver required)
- 1.25-1.44 MB, 3.5-inch
- 2.88 MB, 3.5-inch

#### **1-7.4 PS/2 Keyboard and Mouse Interface**

PS/2 keyboard and mouse connectors are located on the back panel of the motherboard. The +5 V lines to keyboard and mouse connectors are protected with a fuse that prevents motherboard components from being damaged when an over-current condition occurs.

#### *Note*

*The mouse and keyboard can be plugged into either PS/2 connector. Power to the computer should be turned off before a keyboard or mouse is connected or disconnected.*

The keyboard controller contains code, which provides the traditional keyboard and mouse control functions, and also supports Power On/Reset password protection. Power On/Reset password can be specified in the BIOS Setup program.

The keyboard controller also supports the hot-key sequence <Ctrl><Alt><Del>, software reset. This key sequence resets the computer's software by jumping to the beginning of the BIOS code and running the Power On Self Test (POST).

#### **1-7.5 Infrared Support**

The IR connection can be used to transfer files to or from portable devices like laptops, PDAs, and printers.

## 1-8 HARDWARE MONITOR

The optional hardware monitor subsystem provides low-cost instrumentation capabilities. The features of the hardware monitor subsystem include:

- An integrated ambient temperature sensor
- Fan speed sensors, which monitor the fan 1 and fan 2 connectors
- Power supply voltage monitoring to detect levels above or below acceptable values

When suggested ratings for temperature, fan speed, or voltage are exceeded, an interrupt is activated. The hardware monitor component connects to the SMBus.

## 1-9 WAKE ON LAN TECHNOLOGY

Wake on LAN technology enables remote wakeup of the computer through a network. Wake on LAN technology requires a PCI add-in network interface card (NIC) with remote wakeup capabilities. The remote wakeup connector on the NIC must be connected to the onboard Wake on LAN technology connector. The NIC monitors network traffic at the MII interface; upon detecting a Magic Packet, the NIC asserts a wakeup signal that powers up the computer. To access this feature uses the Wake on LAN technology connector.

### ⚠ CAUTION

*For Wake on LAN, the 5-V standby line for the power supply must be capable of delivering  $+5V \pm 5\%$  at 720 mA. Failure to provide adequate standby current when implementing Wake on LAN can damage the power supply.*

## Chapter 2

# HARDWARE INSTALLATION

Congratulations on your purchase of **SY-7ISA+** Motherboard. You are about to install and connect your new Motherboard.



---

**Note:** Do not unpack the Motherboard from its protective anti-static packaging until you have made the following preparations.

---

### 2-1 PREPARATIONS

Gather and prepare all the following hardware equipment to complete the installation successfully:

1. Socket 370 processor with built-in CPU cooling fan.



---

**Note:** This Motherboard supports non-boxed type CPUs.

---

2. DIMM memory module(s)
3. Computer case and chassis with adequate power supply unit
4. Monitor
5. PS/2 Keyboard
6. Pointing Device (PS/2 mouse)
7. Speaker(s) (optional)
8. Disk Drives: HDD, CD-ROM, Floppy drive ...
9. External Peripherals: Printer, Plotter, and Modem (optional)
10. Internal Peripherals: Modem and LAN cards (optional)

## 2-2 UNPACKING THE MOTHERBOARD

When unpacking the Motherboard, check for the following items:

- 
- ◆ The SY-7ISA+ 815E AGP/PCI/CNR Motherboard



- 
- ◆ This Quick Start Guide



- 
- ◆ The Installation CD-ROM



- 
- ◆ SOYO Bonus Pack CD-ROM



- 
- ◆ One IDE Device ATA 100 Flat Cable



- 
- ◆ One Floppy Disk Drive Flat Cable



**Warning:** Do not unpack the Motherboard from its anti-static packaging until you are ready to install it.

---

Like most electronic equipment, your Motherboard may be damaged by electrostatic discharge. To avoid permanent damage to components ground yourself while working by using a grounding strap. Otherwise, ground yourself frequently by touching the unpainted portion of the computer chassis to drain the static charges.

Handle the Motherboard carefully, holding it by the edges. You are now ready to start the installation.

## 2-3 INSTALLATION GUIDE

We will now begin the installation of the Motherboard. Please follow the step-by-step procedure designed to lead you to a complete and correct installation.



---

**Warning:** Turn off the power to the Motherboard, system chassis, and peripheral devices before performing any work on the Motherboard or system.

---

**BEGIN THE INSTALLATION**

### 2-3.1 CPU Installation

To perform the installation of your new **SY-7ISA+** Motherboard, follow the steps below:

**Mark your CPU Frequency:** Record the working frequency of your FCPGA CPU that should be clearly marked on the CPU cover.

#### FSB 66MHz

<input type="checkbox"/> 400MHz (66 x 6.0)	<input type="checkbox"/> 466MHz (66 x 7.0)	<input type="checkbox"/> 533MHz (66 x 8.0)	<input type="checkbox"/> 600MHz (66 x 9.0)	<input type="checkbox"/> 667MHz (66 x 10.0)
<input type="checkbox"/> 433MHz (66 x 6.5)	<input type="checkbox"/> 500MHz (66 x 7.5)	<input type="checkbox"/> 566MHz (66 x 8.5)	<input type="checkbox"/> 633MHz (66 x 9.5)	<input type="checkbox"/> 700MHz (66 x 10.5)

#### FSB 100MHz

<input type="checkbox"/> 500MHz (100 x 5.0)	<input type="checkbox"/> 600MHz (100 x 6.0)	<input type="checkbox"/> 700MHz (100 x 7.0)	<input type="checkbox"/> 800MHz (100 x 8.0)
<input type="checkbox"/> 550MHz (100 x 5.5)	<input type="checkbox"/> 650MHz (100 x 6.5)	<input type="checkbox"/> 750MHz (100 x 7.5)	<input type="checkbox"/> 850MHz (100 x 8.5)

#### FSB 133MHz

<input type="checkbox"/> 533MHz(133x4.0)	<input type="checkbox"/> 667MHz(133x5.0)	<input type="checkbox"/> 800MHz(133x 6.0)	<input type="checkbox"/> 933MHz(133x 7.0)	<input type="checkbox"/> 1.13GHz(133x 8.5)
<input type="checkbox"/> 600MHz(133x4.5)	<input type="checkbox"/> 733MHz(133x5.5)	<input type="checkbox"/> 866MHz(133x 6.5)	<input type="checkbox"/> 1000MHz(133x 7.5)	<input type="checkbox"/>

This Motherboard is designed to support processors with 66/100/133 MHz FSB.

**CPU Mount Procedure:** To mount the processor that you have purchased separately, follow these instructions.

1. Lift the socket handle up to a vertical position.

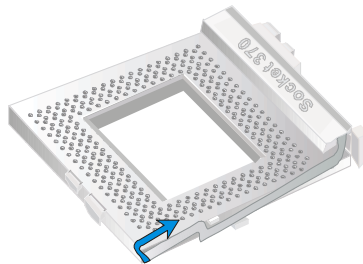



2. Align the blunt edge of the CPU with the matching pinhole distinctive edge on the socket.

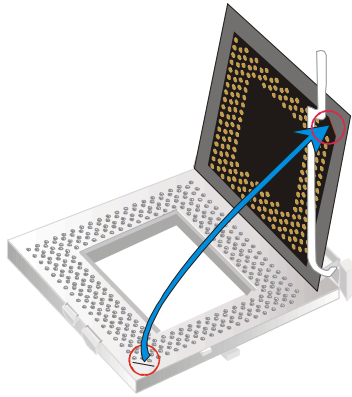

3. Seat the processor in the socket completely and without forcing.

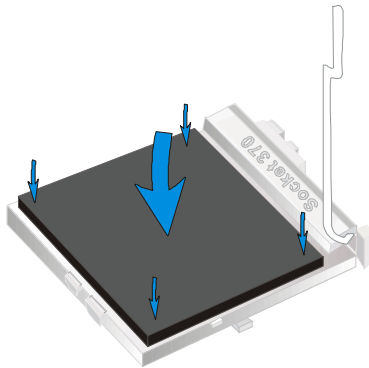

4. Then close the socket handle to secure the CPU in place.

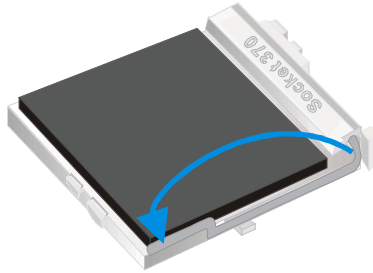

**HOT**

---

Remember to connect the CPU Cooling Fan to the appropriate power connector on the Motherboard. *The fan is a key component that will ensure system stability. The fan prevents overheating, therefore prolonging the life of your CPU.*

---

### 2-3.2 SDRAM Memory Module Installation

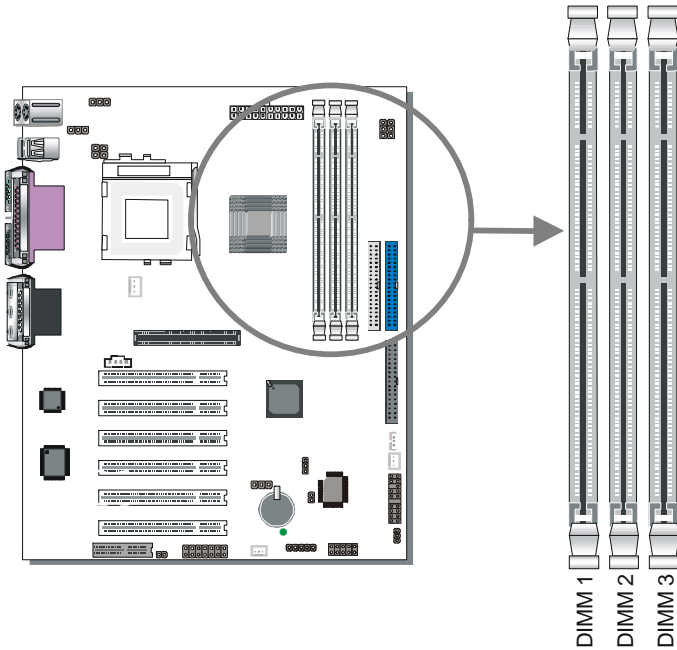

Your board comes with two DIMM sockets, providing support for up to 512MB of main memory using unbuffered and Non-ECC DIMM modules from 32MB to 512MB, No registered DIMM support. **Supports up to 3 Double sided DIMMs at 100MHz system memory. Supports up to 2 double sided or 3 single sided DIMMs a 133MHz system memory bus.**

On this motherboard, DRAM speed can be set independent from the CPU front side bus speed. Depending on the DRAM clock speed setting in the BIOS setup.

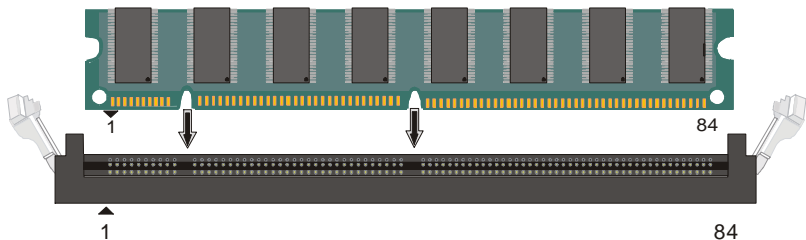

**Memory Configuration Table**

Number of Memory Modules		DIMM 1	DIMM 2	DIMM 3
RAM Type	Single-Side	PC100/PC133	PC100/PC133	PC100/PC133
	Double-Side	PC100	PC100	P100
		PC133	PC133	
			PC133	PC133
Memory Module Size (MB)		32/64/128/256/512 MB		

### 2-3.3 Motherboard Connector

#### 2-3.3.1 IDE Device Installation (HDD, CD-ROM)

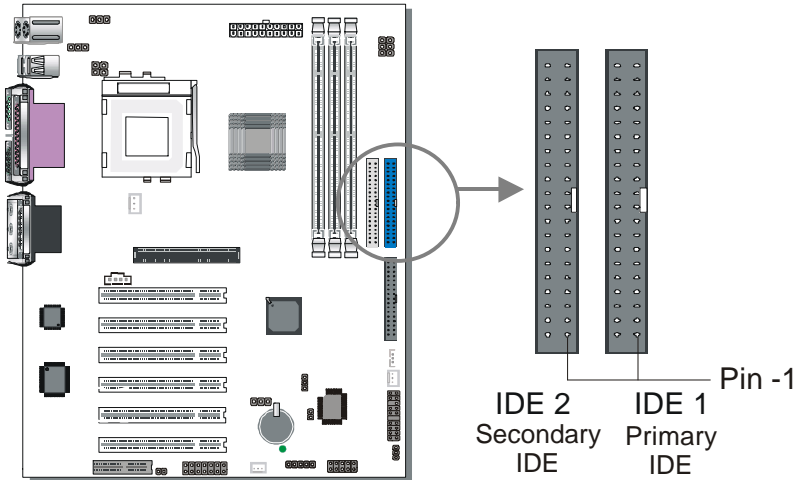

This Motherboard offers two primary and secondary IDE device connectors (IDE1, IDE2.) It can support up to four high-speed HDD or CD-ROM.

Connect one side of the 80-pin flat cable to the IDE device (HDD or CD-ROM) and plug the other end to the primary (IDE1) or secondary (IDE2) directionally keyed IDE connector on the Motherboard.

This Motherboard can support up to four ATA 33/66/100 IDE devices.

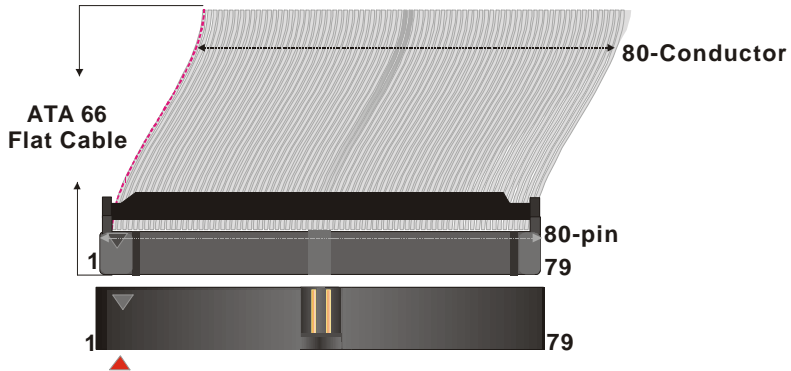

### 2-3.3.2 Floppy Drive Installation

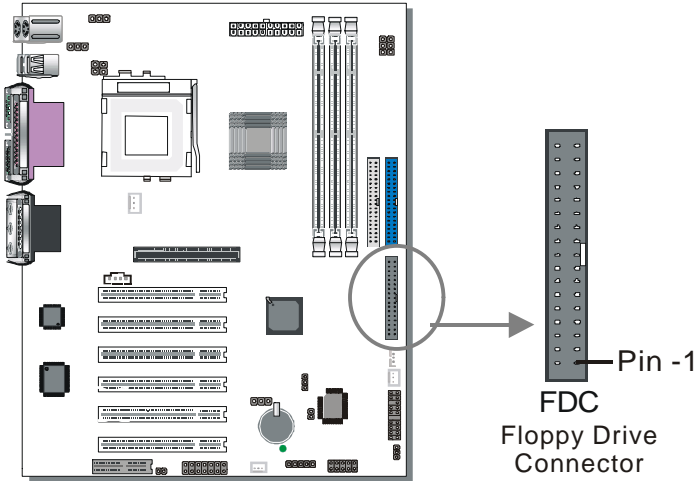

The system supports 5 possible floppy drive types: 720 KB, 1.2 MB, 1.44 MB, 2.88 MB, and LS-120. In addition, this Motherboard supports a 3-mode (720KB/1.2MB/1.44MB) floppy commonly used in Japan.

Connect one side of the 34-pin flat cable to the floppy drive and plug the other end to the floppy drive connector on the Motherboard.

This Motherboard can support up to 2 floppy drives.

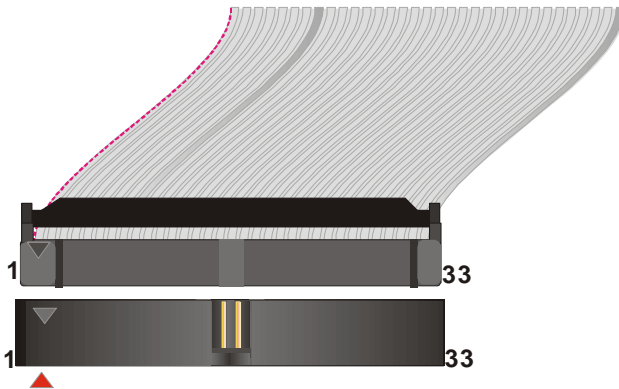

### 2-3.3.3 Front Panel Connections

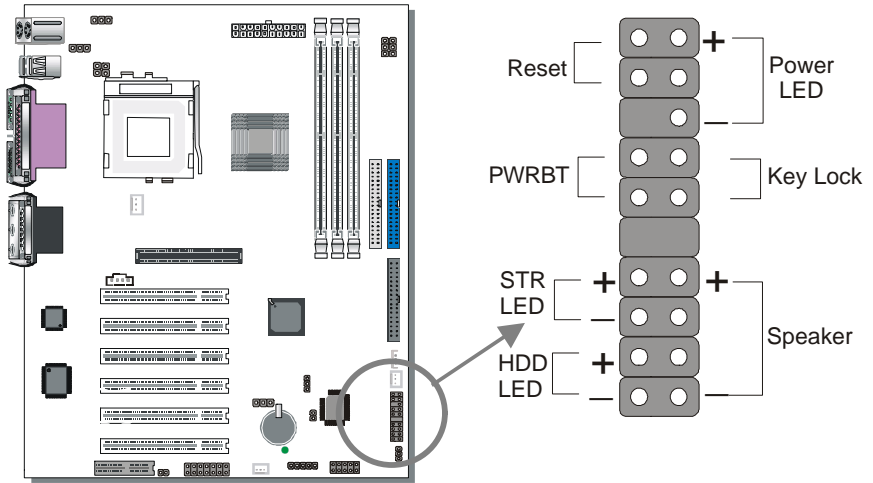

Plug the computer case's front panel devices to the corresponding headers on the Motherboard.

#### 1. Power LED & KeyLock

Plug the Power LED cable into the 5-pin Keylock header.

Some systems may feature a KeyLock function with a front panel switch for enabling or disabling the keyboard. Connect the KeyLock switch to the 5-pin Keylock header on the Motherboard.

Please install according to the following pin assignment: pin 1,3 are for Power LED and pin 4,5 are for Keylock.

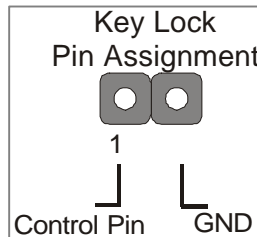
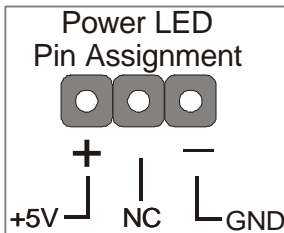

## 2. Reset

Plug the Reset push-button cable into the 2-pin Reset header on the Motherboard. Pushing the Reset button on the front panel will cause the system to restart the boot-up sequence.

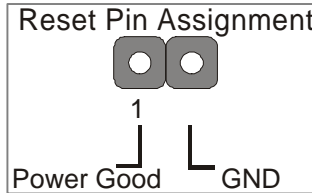

## 3. Speaker

Attach the 4-pin PC speaker cable from the case to the Speaker header on the Motherboard.

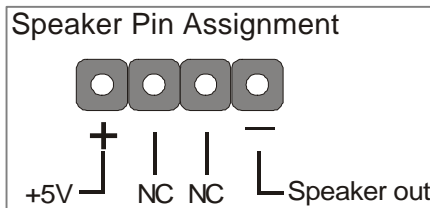

## 4. STR LED

The STR LED is connected to the Voltage that feeds the DIMM sockets. Therefore the following table applies:

	Suspend to RAM	Normal Operation	Power Off
STR LED	ON	ON	OFF

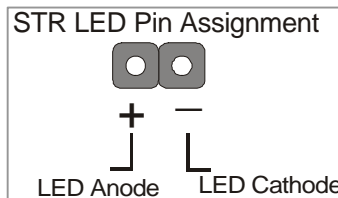



### 5. IDE LED

Attach the 2-pin IDE device LED cable to the corresponding IDE LED header on the Motherboard. This will cause the LED to lighten when an IDE (HDD, CD-ROM) device is active.

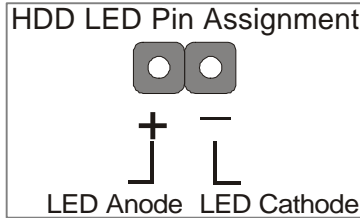

### 6. ATX Power On/Off Switch

Attach the 2-pin momentary type switch to the PWRBT header for turning On or Off your ATX power supply.

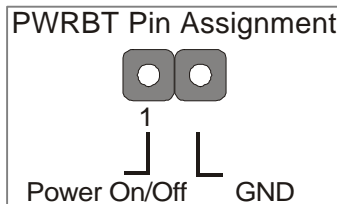

### 2-3.3.4 Back Panel Connections

All external devices such as the PS/2 keyboard, PS/2 mouse, printer, modem, USB can be plugged directly onto the Motherboard back panel. Only after you have fixed and locked the Motherboard to the computer case can you start connecting the external peripheral devices.

When connecting an external device, use the following figure to locate and identify which back panel connector to plug the device to.

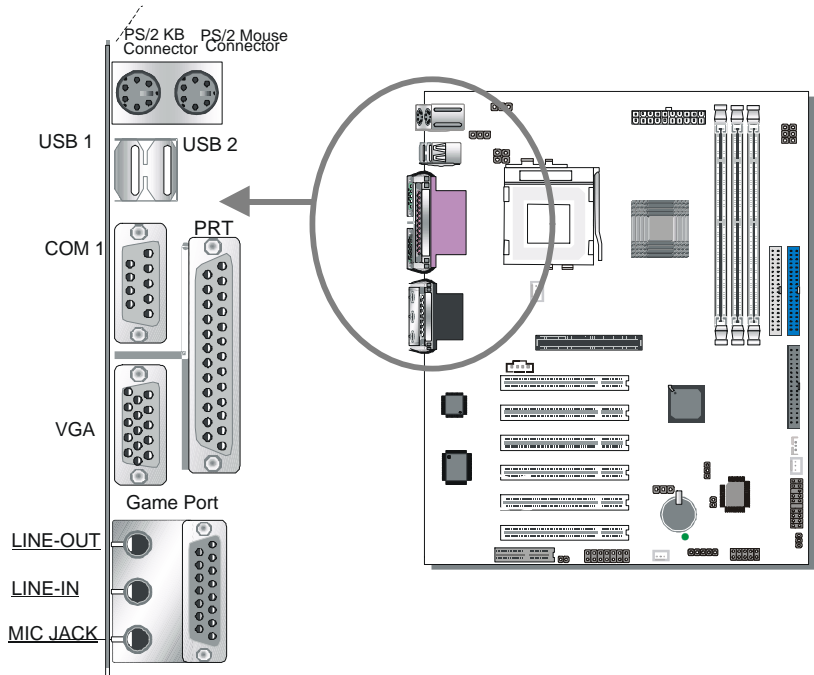

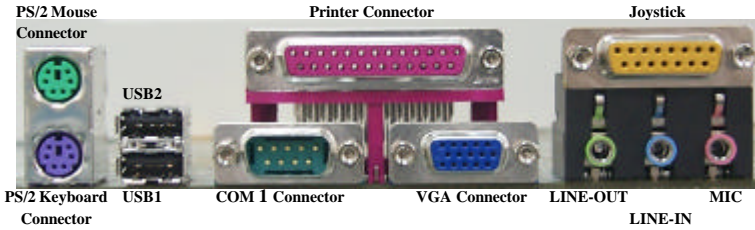

### 1. Parallel Port PRT

This parallel port is used to connect the printer or other parallel devices. Plug the parallel device cable into the 25-pin female connector located at the rear panel of the Motherboard.

Plug the keyboard jack directly into the 6-pin female PS/2 keyboard connector located at the rear panel of the Motherboard.

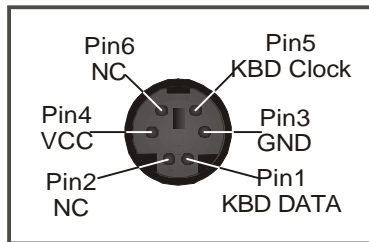

### 2. PS/2 Mouse

Similarly, plug the mouse jack directly into the 6-pin female PS/2 mouse connector.

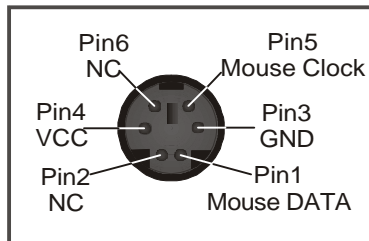

### **3. Universal Serial Bus USB1/USB2**

This Motherboard provides two USB ports for your additional devices. Plug the USB device jack into the available USB connector USB1 or USB2.

- Standard device drivers come with the Win98 for commonly used USB devices.
- With Win95, use the flow UHCI specifications.

### **4. Onboard Serial Port COM1**

External peripherals that use serial transmission scheme include:

- serial mouse,
- and modem.

Plug the serial device cables directly into the COM1 9-pin male connector located at the rear panel of the Motherboard.

### **5. VGA monitor connector**

Plug the monitor cable into the 15-pin female VGA connector located at the rear panel of the motherboard.

### **6. Onboard Joystick port/audio**

This Motherboard provides Joystick port and audio.

- Attach the joystick cable to the 15-pin JOYSTICK port at the rear panel of your motherboard.

7. This Motherboard features three built-in audio-stereo ports (labeled line-in, line-out, and mic jack) convenient to directly plug-in all your external audio devices. **Universal Serial Bus USB1/USB2/(USB3, USB4)**

This Motherboard provides four USB ports for your additional devices. Plug the USB device jack into the available USB connector USB1 or USB2.

- Standard device drivers come with the Win98 for commonly used USB devices.
- With Win95, use the flow UHCI specifications. To use USB devices under Win95, usually you have to install the device that driver comes with the USB device you have purchased.

USB3 and 4 are available. To make use of these USB ports, purchase a USB cable from your dealer. The lay-out of USB3 and 4 is as follows:

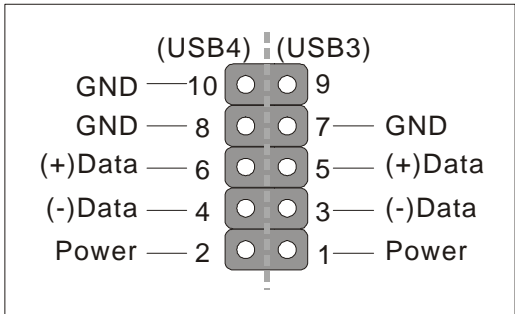

### 2-3.3.5 Other Connections

#### 1. Wake-On-LAN (WOL)

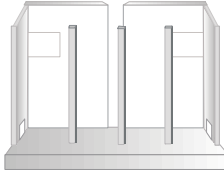

Attach the 3-pin connector from the LAN card which supports the Wake-On-LAN (WOL) function to the JP44 header on the Motherboard. This WOL function lets users wake up the connected computer through the LAN card.

Please install according to the following pin assignment:

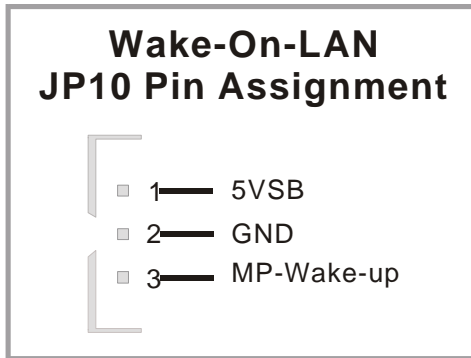

### 2. Infrared (IR1)

Plug the 5-pin infrared device cable to the IR1 header. This will enable the infrared transfer function. This Motherboard meets both the ASKIR and HPSIR specifications.

Please install according to the following pin assignment:

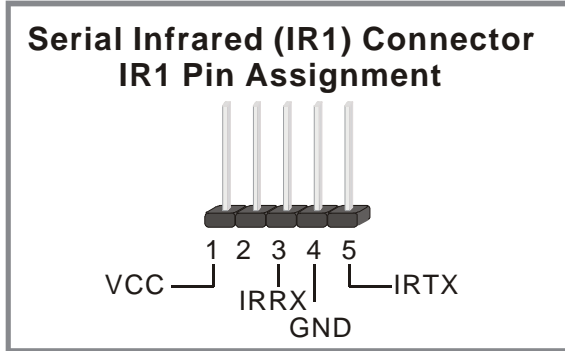

### 3. CD Line-in

This Motherboard provides two CD-Line in connectors. Please connect the 4-pin audio cable from your CD-ROM drive.

Please install according to the following pin assignment:

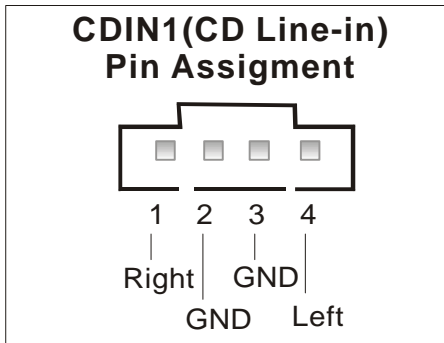

#### 4. Cooling Fan Installation

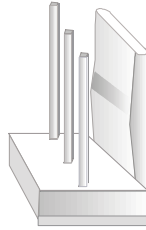

##### (1) CPU Cooling Fan

After you have seated the CPU properly on the processor, attach the 3-pin fan cable to the CPUFAN connector on the Motherboard. The fan will stop when the system enters into Suspend Mode. (Suspend mode can be enabled from the BIOS Setup Utility, [Soyo Combo] menu.)

To avoid damage to the system, install according to the following pin assignment:

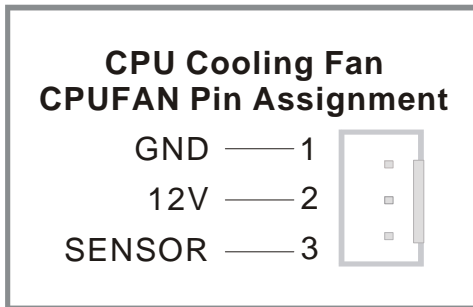



**(2) Chassis Cooling Fan**

Some chassis also feature a cooling fan. This Motherboard features a CHAFAN connector to provide 12V power to the chassis fan. Connect the cable from the chassis fan to the CHAFAN 3-pin connector. Install according to the following pin assignment:

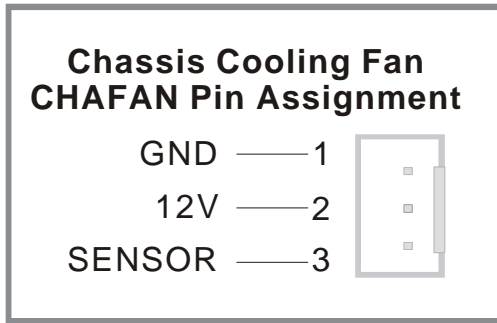

**(3) System Fan**

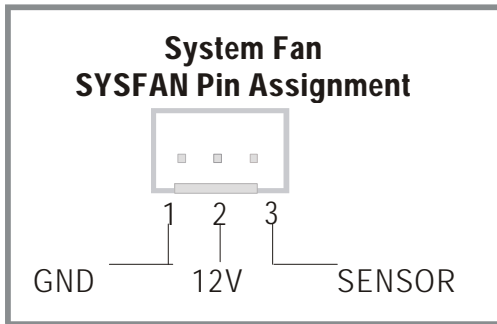

**Note:** CPU cooling fan must be installed to prevent CPU from overheating and ensure system stability. Chassis cooling fan is optional, depending on whether there is cooling fan in your chassis.

## 5. Smart Card Reader

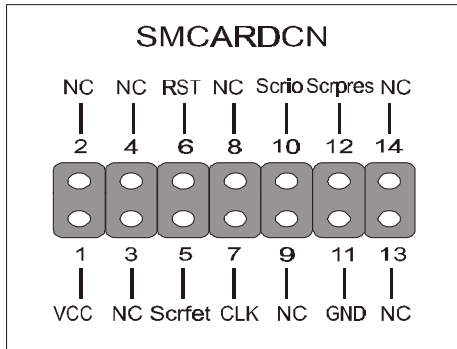

### 2-3.3.6 AGP VGA Card

This motherboard comes with integrated AGP subsystem therefore, AGP VGA card is not needed.

**Other Display Cards:** Insert other types of VGA cards into the PCI or ISA expansion slots according to card specifications.

### 2-3.3.7 ATX Power Supply

Plug the connector from the power directly into the 20-pin male ATX PW connector on the Motherboard, as shown in the following figure.

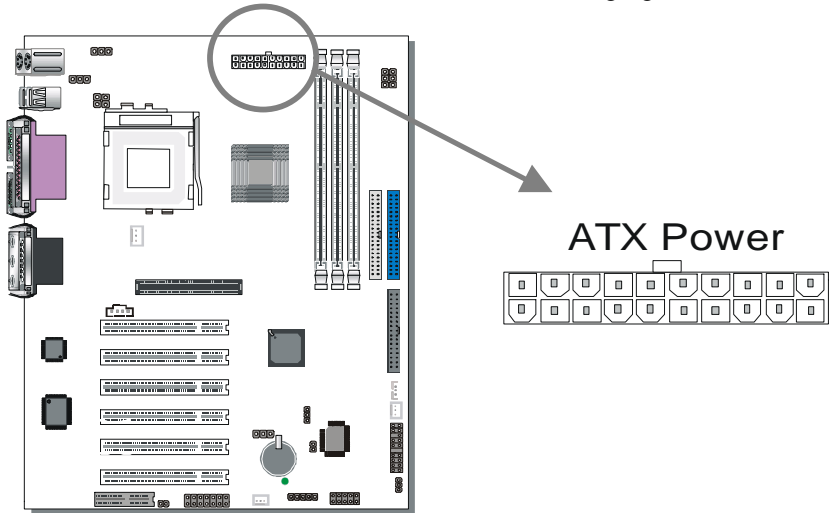

---

**Warning:** Follow these precautions to preserve your Motherboard from any remnant currents when connecting to ATX power supply:



**Turn off the power supply and unplug the power cord of the ATX power supply before connecting to ATX PW connector.**

---

The Motherboard requires a power supply with at least 200 Watts and a "power good" signal. Make sure the ATX power supply can take at least 720 mA \* load on the 5V Standby lead (5VSB) to meet the standard ATX specification.

\* **Note:** If you use the Wake-On-LAN (WOL) function, make sure the ATX power supply can support at least 720 mA on the 5V Standby lead (5VSB).

Please install the ATX power according to the following pin assignment:

### ATX Power

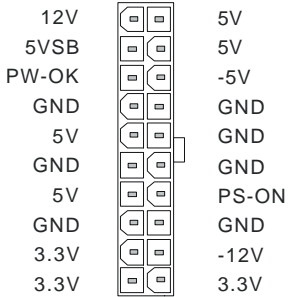

➤ **Pay special care to the directionality.**

### 2-3.3.8 CNR (Communication Networking Riser)Connector

This motherboard supports CNR (Communication Networking Riser) slot

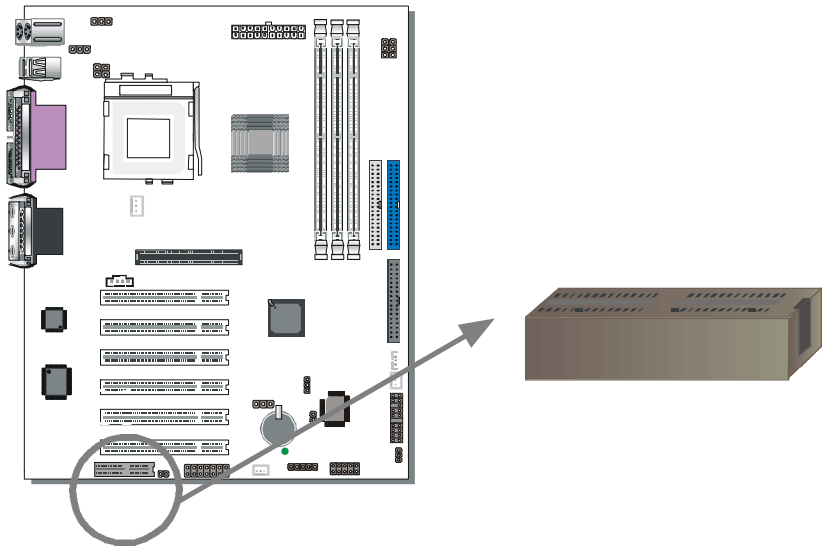



### 2-3.4 Jumper Setting

**Step 1.** 5V Stand-by indicator LED (LED 5)

This LED is lit whenever the 5V Standby voltage coming from the ATX powersupply is available. If you have connected your ATX powersupply to the mains, LED 5 should be lit.

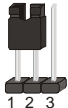

**Step 2.** Enable/Disable Power-On by Keyboard (JP1)

You may choose to enable the Power-On through Keyboard function by shorting pin 1-2 on jumper JP1; or short pin 2-3 to disable this function.



Power-On by Keyboard	Enable	Disable
<b>JP1 Setting</b>	Short pin 1-2 to enable the Power-On by Keyboard function. 	Short pin 2-3 and the Power-On by Keyboard function is disabled. 
<b>Important:</b> When using the Power-On by Keyboard function, please make sure the ATX power supply is able to provide at least 720mA on the 5V Standby lead (5VSB) in order to meet the standard ATX specification.		

**Step 3.** Enable/Disable USB Keyboard Wake Up(JP34)

You may choose to enable the USB Keyboard Wake Up function by shorting pin 2-3 on jumper JP34; or short pin 1-2 to disable this function.

USB Keyboard Wake Up	Enable	Disable
<b>JP34 Setting</b>	Short pin 2-3 to enable the USB Keyboard Wake Up function. 	Short pin 1-2 and the USB Keyboard Wake Up function is disabled. 
<b>Important:</b> When using the USB Keyboard Wake Up function, please make sure the ATX power supply is able to provide at least 720mA on the 5V Standby lead (5VSB) in order to meet the standard ATX specification.		



**Step 4.** CNR MR Card-CODEC OPTION (JP8)

CNR MR Card-CODEC OPTION	Primary	Secondary
<b>JP8 Setting</b>	<b>open JP8</b> 	<b>Short JP8</b> 

**Step 5.** Set JP9 for FWH Boot Block Write-Protect



Setting this jumper to open will prevent the boot block area of the FWH (FirmWare Hub) chip from being written data into such that it is write-protected from unwanted or abnormal write activity.

*Note: In some rare cases, the boot block area will need to be flashed to complete the BIOS upgrade procedure. Setting JP9 to open will cause incomplete BIOS update in that case.*

The FWH Boot Block Write-Protect	Locked	Unlocked
<b>JP9 Setting</b>	<b>Open JP9</b> 	<b>Short JP9</b> 

**Step 6.** SPEAKER OPTION (JP22)

Through this jumper the case speaker output can be redirected to the external (amplified) speakers (if connected) through the on-board Audio-Codec.

SPEAKER OPTION	Lineout SPK	CASE SPK
<b>JP22 Setting</b>	<b>Short pin 1-2</b> 	<b>Short pin 2-3</b> 

















**Step 7.** CPU Frequency Settings: JP6, JP7, CJ1 and CJ2

For certain Intel CPUs, the multiplier is not locked such that setting a multiplier higher than specified on the CPU is possible. For technical details read the following:

Your FC-PGA 133/100/66 MHz FSB CPU has a pin JP6, JP7 to tell it what FSB frequency the CPU requires; If these two jumpers are shorted the motherboard will automatically run at the frequency the CPU was specified to run at.

However, the FSB Frequency can also be set through jumpers CJ1 and CJ2 and it may therefore differ from the Frequency the CPU specifies. If CJ1 and CJ2 are to be used, JP6 & JP7 must be open. Doing so may however force your CPU to operate out of its specifications and therefore SOYO can not guarantee the proper functioning of your system.

Refer to the following table:

CPU Frequency		JP6	JP7	CJ1	CJ2
<b>Automatic</b>		Short 	Short 	Open 	Open 
<b>Manual</b>	<b>66MHz</b>	Open 	Open 	2-3 	2-3 
	<b>100MHz</b>	Open 	Open 	1-2 	2-3 
	<b>133MHz</b>	Open 	Open 	1-2 	1-2 

### 2-3.5 Voice Doctor

If the system does not boot-up properly, the Voice Doctor will inform the user by voice through internal/external speaker at what point in boot-up sequence the problem arises.

Below are the possible errors the user may encounter:

The Processor might be damage or not installed properly

The memory module might be damage or not installed properly



No Keyboard connected

VGA card might be damage or not inserted properly

Defective HD-Driver (IDE)

Floppy might error



Voice Doctor supports two language, refer the table below on the language you prefer.

Voice Doctor's language	English Language	Chinese Language
<b>JP33 Setting</b>	<b>Short pin 1-2</b> 	<b>Short pin 2-3</b> 

### 2-3.6 CMOS Clear (JP5)

In some cases the CMOS memory may contain wrong data, follow the steps below to clear CMOS memory.

1. Clear the CMOS memory by momentarily shorting pin 2-3 on jumper JP5. This jumper can be easily identified by its white colored cap.
2. Then put the jumper back to 1-2 to allow writing new of data into the CMOS memory.

CMOS Clearing	Clear CMOS Data	Retain CMOS Data
<b>JP5 Setting</b>	Short pin 2-3 for at least 5 seconds to clear the CMOS 	Short pin 1-2 to retain new settings 

*Note: You must unplug the ATX power cable from the ATX power connector when performing the CMOS Clear operation.*



### 2-3.7 Power On

You have now completed the hardware installation of your Motherboard successfully.

1. Turn the power on
2. To enter the BIOS Setup Utility, press the <DEL> key while the system is performing the diagnostic checks,



**Note:** If you have failed to enter the BIOS, wait until the boot up sequence is completed. Then push the RESET button and press <DEL> key again at the beginning of boot-up, during diagnostic checks.

Repeat this operation until you get the following screen.

3. The BIOS Setup screen appears:

CMOS Setup Utility – Copyright ( C ) 1984-2000 Award Software	
<ul style="list-style-type: none"> <li>▶ Soyo Combo Feature</li> <li>▶ Standard CMOS Features</li> <li>▶ Advanced BIOS Features</li> <li>▶ Advanced Chipset Features</li> <li>▶ Integrated Peripherals</li> <li>▶ Power Management Setup</li> <li>▶ PnP/PCI Configurations</li> </ul>	<ul style="list-style-type: none"> <li>▶ PC Health Status</li> <li>Load Fail - Safe Defaults</li> <li>Load Optimized Defaults</li> <li>Set Supervisor Password</li> <li>Set User Password</li> <li>Save &amp; Exit Setup</li> <li>Exit Without Saving</li> </ul>
Esc : Quit <span style="float: right;">↑↓→← : Select Item</span> F10 : Save & Exit Setup	
Change CPU's Clock & Voltage	

### **2-3.8 Quick BIOS Setup**

This Motherboard does not use any hardware jumpers to set the CPU frequency. Instead, CPU settings are software configurable with the BIOS **[Soyo Combo Feature]**. The [Soyo Combo Feature] menu combines the main parameters that you need to configure, all in one menu, for a quick setup in BIOS.

After the hardware installation is complete, turn the power switch on, then press the <DEL> key during the system diagnostic checks to enter the Award BIOS Setup program. The CMOS SETUP UTILITY will display on screen. Follow these steps to configure the CPU settings.

SETUP UTILITY will display on screen. Then, follow these steps to configure the CPU settings.

**Step 1.** Select [STANDARD CMOS SETUP]

Set [Date/Time] and [Floppy drive type], then set [Hard Disk Type] to “Auto”.

**Step 2.** Select [Load Optimized Defaults]

Select the “Load Optimized Defaults” menu and type “Y” at the prompt to load the BIOS optimal setup.

**Step 3.** Select [Soyo Combo Feature]

Move the cursor to the [CPU Frequency] field to set the CPU frequency.

The following table shows all available [CPU Frequency] settings on your SY-7ISA+ Motherboard . If you set this field to [Manual], you will be required to fill in the next two consecutive fields: (1) the CPU Host/PCI Clock, and (2) the CPU Ratio.

CPU Frequency (MHz)		
<input type="checkbox"/> 667MHz (66 x 10.0)	<input type="checkbox"/> 850MHz (100 x 8.5)	
<input type="checkbox"/> Manual	<input type="checkbox"/> 700MHz (66 x 10.5)	<input type="checkbox"/> 600MHz (133 x 4.5)
<input type="checkbox"/> 400MHz (66 x 6.0)	<input type="checkbox"/> 500MHz (100 x 5.0)	<input type="checkbox"/> 666MHz (133 x 5.0)
<input type="checkbox"/> 433MHz (66 x 6.5)	<input type="checkbox"/> 550MHz (100 x 5.5)	<input type="checkbox"/> 733MHz (133 x 5.5)
<input type="checkbox"/> 466MHz (66 x 7.0)	<input type="checkbox"/> 600MHz (100 x 6.0)	<input type="checkbox"/> 800MHz (133 x 6.0)
<input type="checkbox"/> 500MHz (66 x 7.5)	<input type="checkbox"/> 650MHz (100 x 6.5)	<input type="checkbox"/> 866MHz (133 x 6.5)
<input type="checkbox"/> 533MHz (66 x 8.0)	<input type="checkbox"/> 700MHz (100 x 7.0)	<input type="checkbox"/> 933MHz (133 x 7.0)
<input type="checkbox"/> 566MHz (66 x 8.5)	<input type="checkbox"/> 750MHz (100 x 7.5)	<input type="checkbox"/> 1000MHz (133 x 7.5)
<input type="checkbox"/> 600MHz (66 x 9.0)	<input type="checkbox"/> 750MHz (100 x 7.5)	<input type="checkbox"/> 1.13GHz (133 x 8.5)
<input type="checkbox"/> 633MHz (66 x 9.5)	<input type="checkbox"/> 800MHz (100 x 8.0)	<input type="checkbox"/>

Select the working frequency of your Pentium® III, Celeron™ processor among these preset values.

**Note:**  Mark the checkbox that corresponds to the working frequency of your Pentium® III, Celeron™ processor in case the CMOS configuration should be lost.

**Step 4.** Select [Save & Exit Setup]

Press <Enter> to save the new configuration to the CMOS memory, and continue the boot sequence.

## 2-3.9 Troubleshooting at First Start

### Video (no display) related issues

**I built a new computer system using a Soyo board and nothing happens when turning it on, no video and no beeps from the PC speaker. What is happening and how can it be fixed?**

No screen and no beeps mean that your CPU and motherboard do not work at all. It could be that the CPU is not seated correctly or that a component on the M/B is grounded (shorted) with the case. Also make sure to check the voltage setting switch (110V/220V) on the back of the power supply. To isolate the problem do the following:

1. Press and hold down on the “Ins” (insert) key while turning on the computer until you get video. If you do not get video then,
2. Double-check jumpers setting on you motherboard and remove all add-on cards, unplug all hard-disk and floppy-disk drive cables and see if you can hear some beeps. If you still do not get any beeps, then try putting the motherboard on the table (to isolate it from the case) with the CPU and speaker only, and give it one more try.

**I hear a series of beeps and I do not get anything from my monitor. What could be wrong?**

The following lists some basic beep codes and their possible meanings:

- One long beep and 3 very short beeps - The video card is not detected by the motherboard. Please re-seat your video card. If you are using an AGP card, please push your AGP card down real hard. You may have to push VERY hard without the AGP card mounting screw. Make sure not to insert the card the other way around.
- Continuous beeps – One or more of the memory modules is not seated correctly in its socket.

**My PCI VGA card works fine with my system, but when I put in a new AGP card, it does not give me any video. Is my AGP slot bad?**

This is a common problem with AGP video cards. The reason is that your AGP card did not get seated into the AGP slot fully and firmly. Please push your AGP card down into the socket real hard, it should snap twice. You may have to unscrew the AGP card to allow the card to go further down. Do take care not to damage the card by using too much force.

**I get distorted video my AGP card right after I save my bios. Why is that?**

The cause is likely that your AGP card is not running at the correct bus speed. To fix this, please clear the CMOS via JP5 and if it still does not work, please upgrade your motherboard bios to the latest version.

## **BIOS Issues**

**Where can I find the BIOS revision of my mainboard?**

It will be displayed on the up-left corner on the screen during boot-up. It will show as your board type followed by the revision number, such as 5EH\_2CA1 (meaning revision 2CA1 for the SY-5EH board) or 6BA+ IV\_2AA2 which means SY-6BA+ IV motherboard with 2AA2 bios.

**Where can I find the latest BIOS of my motherboard?**

Please go to the technical support page of one of the SOYO websites (Taiwan: [www.soyo.com.tw](http://www.soyo.com.tw)), and look up your motherboard to find the latest BIOS revision.

## **Hard disk, floppy drive, CD-ROM etc**

**When I boot up my new computer I got "floppy boot failure" and the LED on the floppy stays on**

Make sure the red wire of floppy ribbon cable goes to Pin1 on the floppy drive side (don't trust the "key lock" or "notch") and use the end-connector of the cable (don't use middle one).

## **Modem issues**

**I get an "I/O Conflict" message when I turn on my system and I can**

**not get my modem to work**

What you need to do is to disable 'COM2' (or UART2 or serial port 2) in the bios under integrated peripheral setup.

**I have installed my modem drivers several times and I still cannot get my modem to work. Why?**

If you are sure that the modem driver has been installed correctly, then you need to install the south bridge driver from the SOYO CD, this is because Windows does not properly recognize relatively new chipsets.

**Audio Issues**

**I do not get any sound from my sound card. What could be wrong?**

Please make sure the speaker is connected to the speaker out port on your sound card.

**In Device Manager, I keep getting yellow exclamation signs on my sound port even though I have installed my sound driver several times and I could not get my sound card to work. What is wrong?**

It is likely that you did not have the correct driver installed. If you are sure that the correct sound driver has been installed, then please install the 'south bridge' driver for the motherboard.

**The sound is working in my system, but when I play CD music from the CD-ROM, I do not get any sound. What is wrong?**

This is because the 3-wire audio cable from the CD-ROM to the sound card is not connected or it is loose.

**The sound from my sound card is distorted when Windows starts. What is wrong?**

First, if you are using an ISA sound card, please make sure the IRQ needed for the sound card is set to 'Legacy ISA' in the bios. In other words, if your ISA sound card takes IRQ5, then set IRQ5 to 'Legacy ISA'. Next, install the 'south bridge' driver for the motherboard.

---

**The sound and everything else works fine except that the recorder and microphone do not work. What is wrong?**

This is because the recorder and microphone in the Windows are not enabled. Please go to sound properties and enable them.

**Lock up (freeze)**

**When I boot up my system, everything works fine. It sees my CPU and memory, detects my hard drive, floppy drive and CD-ROM but locks up at "Verify DMI pool data... ", and it won't go any further. What should I do?**

Please clear the CMOS via JP5 then choose 'load setup default' in the bios and save the bios and exit. Next, unplug all other add-on cards except the video card and floppy drive controller, and see if it can boot from floppy. Then put back the peripherals one by one to identify which one causes the lockup. If you are running a Cyrix CPU, make sure the 'linear burst function' is enabled in the bios.

**I can not get my board to run properly.**

Please make sure you have the latest bios and driver from the SOYO web site at: <http://www.soyo.com>



### ***Note on Over-clocking Capability***

The SY-7ISA+ provides over-clocking capability. Due to the over-clocking setting your system may fail to boot up or hang during run time. Please perform the following steps to recover your system from the abnormal situation :

1. Turn off system power (If you use an ATX power supply, and depending on your system, you may have to press the power button for more than 4 seconds to shut down the system.)
2. Press and hold down the <Insert> key while turning on the system power. Keep holding down the <Insert> key until you see the message of the CPU type and frequency shown on the screen.
3. Press the <Del> key during the system diagnostic checks to enter the Award BIOS Setup program.
4. Select [Save & Exit SETUP] and press <Enter> to save the new configuration to the CMOS memory, and continue the boot sequence.

**Note: SOYO does not guarantee system stability if the user over clocks the system. Any malfunctions due to over-clocking are not covered by the warranty.**

### **2-3.10 Power Off**

There are two possible ways to turn off the system:

1. Use the **Shutdown** command in the **Start Menu** of Windows 95/98 to turn off your computer.
2. Press the mechanical power-button and **hold down for over 4 seconds**, to shutdown the computer. If you press the power-button for less than 4 seconds, then your system will enter into **Suspend Mode**.

You are now ready to configure your system with the BIOS setup program. Go to **Chapter 3: BIOS SETUP**



## Chapter 3

# BIOS SETUP UTILITY

This Motherboard's BIOS setup program uses the ROM PCI/ISA BIOS program from Award Software Inc.

To enter the Award BIOS program's Main Menu:

1. Turn on or reboot the system.
2. After the diagnostic checks, press the [Del] key to enter the Award BIOS Setup Utility.

CMOS Setup Utility – Copyright ( C ) 1984-2000 Award Software	
<ul style="list-style-type: none"> <li>▶ Soyo Combo Feature</li> <li>▶ Standard CMOS Features</li> <li>▶ Advanced BIOS Features</li> <li>▶ Advanced Chipset Features</li> <li>▶ Integrated Peripherals</li> <li>▶ Power Management Setup</li> <li>▶ PnP/PCI Configurations</li> </ul>	<ul style="list-style-type: none"> <li>▶ PC Health Status</li> <li>Load Fail - Safe Defaults</li> <li>Load Optimized Defaults</li> <li>Set Supervisor Password</li> <li>Set User Password</li> <li>Save &amp; Exit Setup</li> <li>Exit Without Saving</li> </ul>
Esc : Quit <span style="float: right;">↑↓→← : Select Item</span> F10 : Save & Exit Setup	
Change CPU's Clock & Voltage	

### Selecting items

- Use the arrow keys to move between items and select fields.
- From the Main Menu press arrow keys to enter the selected submenu.

### Modifying selected items

- Use the [Up]/[Down] keys to modify values within the selected fields. Some fields let you enter values directly.

**Hot Keys:** Function keys give you access to a group of commands throughout the BIOS utility.

Function	Command	Description
<b>F1</b>	General Help	Gives the list of options available for each item.
<b>F5</b>	Previous Values	Restore the old values. These are the values that the user started the current session with.
<b>F6</b>	Load Fail-Safe Defaults	Loads all items with the most conservative values.
<b>F7</b>	Load Optimized Defaults	Loads all options with the optimize values.
<b>F10</b>	Save	Saves your changes and reboots the system.
<b>[Esc]</b>	Exit	Returns at anytime and from any location to the Main Menu.
<b>[Enter]</b>	Select	Will display a overlapping window with all options for the current item.
<b>[+/-/PU/PD]</b>	Value	Using the +, -, Page Up and Page Down keys the user can toggle the value of the current item.

### SAVE AND EXIT SETUP

Select the [SAVE & EXIT SETUP] option from the Main Menu to save data to CMOS and exit the setup utility. This option saves all your changes and causes the system to reboot.

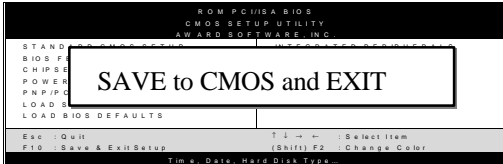

Type [Y] to save the changes and exit or [N] to return to the Main Menu and keep current values.

### EXIT WITHOUT SAVING

Selecting the [EXIT WITHOUT SAVING] option allows you to abandon all data and exit setup, therefore ignoring all your changes.

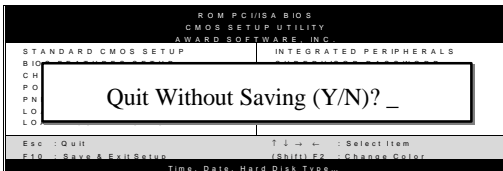

Type [Y] to abandon changes and exit or [N] to return to the Main Menu and keep current values.

### 3-1 SOYO COMBO SETUP

This Motherboard does not use any hardware jumpers to set the CPU frequency. Instead, CPU settings are software configurable with the BIOS [SOYO COMBO SETUP].

After the hardware installation is complete, turn the power switch on, then press the <DEL> key during the system diagnostic checks to enter the Award BIOS Setup program. The CMOS SETUP UTILITY will display on screen. Then, select the [SOYO COMBO SETUP] option from the main menu and press the <Enter> key.

CMOS Setup Utility – Copyright ( C ) 1984-2000 Award Software  
Soyo Combo Feature

CPU Host/ PCI Clock/ PC133	100/ 33 MHz		Item Help
CPU Clock Ratio	X 3		Menu Level ▶
CPU L2 Cache ECC Checking	Enabled		
Auto Detect DIMM/ PCI CLK	Enabled		
Spread Spectrum	Disabled		
C.I.H. 4-WAY Protection	Enabled		
Onboard codec control	Enabled		
Quick Power On Self Test	Enabled		
System Memory Frequency	Auto		
SDRAM CAS Latency Time	3		
SDRAM Cycle Time Tras/ Trc	7/ 9		
SDRAM RAS-to-CAS Delay	3		
SDRAM RAS Precharge Time	3		
First Boot Device	Floppy		
Second Boot Device	HDD-0		
Third Boot Device	LS120		
Boot Other Device	Enabled		
AC97 Audio	Auto		
AC97 Modem	Auto		

↑↓→: Move    Enter: Select    + / - / PU / PD : Value    F10 : Save    ESC : Exit    F1: General Help  
 F5 : Previous Values                      F6 : Fail - Safe Defaults                      F7 : Optimized Defaults

The [SOYO COMBO SETUP] menu combines the main parameters that you need to configure, all in one menu, for a quick setup in BIOS.

### 3-1.1 Quick CPU Frequency Setup

Quick CPU Frequency Setup	Setting		Description
CPU Host/PCI Clock	Default	110/37MHz/NO	Select the host clock of your Socket 370 processor among these values. <b>Note:</b> For the 815 chipset, 66, 100 and 133 MHz host clock frequencies are acceptable. However, the system stability is not guaranteed for other frequencies due to the limitations of this chipset.
	66/33MHz/NO	115/38MHz/NO	
	68/35MHz/NO	133/33MHz/Yes	
	70/35MHz/NO	137/34MHz/Yes	
	75/38MHz/NO	140/35MHz/Yes	
	80/40MHz/NO	145/36MHz/Yes	
	83/42MHz/NO	150/37MHz/Yes	
	100/33MHz/NO	160/38MHz/Yes	
	103/34MHz/NO	166/42MHz/Yes	
	105/35MHz/NO		
CPU Clock Ratio	After you have selected the host clock, choose the right multiplier for the CPU. Options are: [2, 2.5, 3, 3.5, 4, 4.5, 5, 5.5, 6, 6.5, 7.0, 7.5, 8.0]. The CPU frequency is then defined as [host clock freq.][x][multiplier], and should be the working frequency of your Pentium® III, Pentium® II & Celeron™ processor.		

### 3-1.2 L2 Cache Memory

	Setting	Description	Note
CPU L2 Cache ECC Checking	Disabled		
	Enabled	This option activates the CPU L2 cache ECC checking function.	Default

### 3-1.3 Frequency/ Voltage Control

	Setting	Description	Note
Auto Detect DIMM/PCI Clk	Disabled	When enabled, this item will auto detect if the DIMM and PCI socket have devices and will send clock signal to DIMM and PCI devices. When disabled, it will send the clock signal to all DIMM and PCI socket.	Default
	Enabled		

### Frequency/ Voltage Control (Continued)

	Setting	Description	Note
Spread Spectrum	Disabled	This item allows you to enable/disable the spread spectrum modulate.t.	Default
	Enabled		

### 3-1.4 C.I.H. 4-WAY Protection Settings

	Setting	Description	Note
C.I.H. 4-WAY Protection	Disabled	When set to enabled, the BIOS can only be programmed through AWDFLASH, making sure that any virus is unable to program the system BIOS. Set to disable the BIOS can be programmed the traditional way.	Default
	Enabled		

### 3-1.5 Onboard Codec Control Setting

	Setting	Description	Note
Onboard codec control	Disabled	If you want to use a 6 channel CNR card or PCI sound card, set this item to disabled.	Default
	Enabled		

### 3-1.6 Quick Power On Self Test

	Setting	Description	Note
Quick Power On Self Test	Disabled	Provides a fast POTS at boot-up.	Default
	Enabled		

### 3-1.7 System Memory Control Setting

System Memory Control Setting	Setting	Description	Note
System Memory Frequency	Auto	Set this item to auto for automatic detection of the system memory frequency. For a fixed frequency set to 100 or 133MHz.	Default
	100		
	133		
SDRAM CAS Latency Time	3	Use the default setting	Default
	2		
SDRAM Cycle Time Tras/Trc	7/9	Use the default setting	Default
	5/7		

**System Memory Control Setting (Continued)**

System Memory Control Setting	Setting	Description	Note
<b>SDRAM RAS-to-CAS Delay</b>	3	Use the default setting	Default
	2		
<b>SDRAM RAS Precharge Time</b>	3	If an insufficient number of cycles is allowed for the RAS to accumulate its charge before DRAM refresh, the refresh may be incomplete and the DRAM may fail to retain data. Fast gives faster performance; and Slow gives more stable performance. This field applies only when synchronous DRAM is installed in the system.	Default
	2		

**3-1.8 System Boot Control Settings**

System Boot Control Settings	Setting	Description	Note
<b>First /Second/Third Boot Device</b>	Floppy	Select Your Boot Device Priority	
	LS/ZIP		
	HDD-0		
	SCSI		
	CDROM		
	HDD-1		
	HDD-2		
	HDD-3		
	LAN		
	Disabled		
<b>Boot Other Device</b>	Disabled	Select Your Boot Device Priority	Default
	Enabled		
<b>AC97 Audio/Modem</b>	Disabled	This item allows you to decide to auto/disable the 810 chipset family to support AC97 Audio/Modem.	Default
	Auto		

### 3-2 STANDARD CMOS SETUP

Select the [STANDARD CMOS SETUP] option from the Main Menu and press [Enter] key.

CMOS Setup Utility – Copyright ( C ) 1984-2000 Award Software  
 Standard CMOS Features

Date (mm:dd:yy)	Sat, Jan 1 2000	Item Help
Time (hh:mm:ss)	2 : 8 : 54	
▶ IDE Primary Master	None	Menu Level ▶
▶ IDE Primary Slave	None	
▶ IDE Secondary Master	None	
▶ IDE Secondary Slave	None	
Drive A	1.44M, 3.5 in.	
Drive B	None	
Floppy 3 Mode Support	Disabled	
Video	EGA/VGA	
Halt On	All Errors	
Base Memory	640K	
Extended Memory	129024K	
Total Memory	130048K	

↑↓→: Move    Enter : Select    + / - / PU / PD : Value    F10 : Save    ESC : Exit    F1: General Help  
 F5 : Previous Values    F6 : Fail - Safe Defaults    F7 : Optimized Defaults

This screen allows you to modify the basic CMOS settings. After you have completed the changes, press [Esc] key to return to the Main Menu.

#### 3-2.1 Date & Time

	Display	Setting	Please Note
<b>Date</b>	mm/dd/yyyy	Type the current date	You can also the PUp/PDn keys to toggle
<b>Time</b>	hh:mm:ss	Type the current time	24-hour clock format 3:15 PM is displayed as 15:15:00



### 3-2.2 Hard Disks Type & Mode

Choose the type and mode for the hard disks that you have already installed.

Primary (Secondary) Master & Slave	Setting	Description	Note
<b>IDE HDD Auto-Detection</b>	Press Enter	To auto-detect the HDD's size, head ..on this channel	
	Auto	BIOS detects hard disk type automatically.	Default
<b>IDE Primary Slave (User Type)</b>	User	User defines the type of hard disk.	
	None		
<b>Access Mode</b>	Auto	BIOS detects hard disk mode automatically.	Default
	Normal	Normal IDE hard disk	<528MB
	LBA	Enhanced IDE hard disk	>528MB
	Large	Large IDE hard disk (for certain hard disk)	



**Note:** If you have any questions on your hard disk type or mode, ask your hard disk provider or previous user for details.

### 3-2.3 Floppy Drives

Floppy Drives	Setting	Description	Note
<b>Drives A &amp; B</b>	360KB, 5.25 in.		
	1.2MB, 5.25 in.		
	720KB, 3.5 in.		
	1.44MB, 3.5 in.		Default
	2.88MB, 3.5 in.		
	None	Not installed	
<b>Floppy 3-Mode Support</b>	Disabled		Default
	Drive A Drive B Both	Supports 3-mode floppy diskette: 740KB/1.2MB/ 1.44MB on selected disk drive.	Special disk drive commonly used in Japan

### 3-2.4 Others Optional

	Setting	Description	Note
<b>Video</b>	EGA/VGA	Select the video mode.	Default
	CGA 40		
	CGA 80		
	MONO (Monochrome)		
<b>Halt On</b>	ALL Errors	When the BIOS detects system errors, this function will stop the system. Select which type of error will cause the system halt.	Default
	No Errors		
	All, But Keyboard		
	All, But Diskette		
	All, But Disk/Key		

### 3-3 ADVANCED BIOS FEATURES

Select the [Advanced BIOS Features] option from the Main Menu and press [Enter] key.

CMOS Setup Utility – Copyright ( C ) 1984-2000 Award Software  
 Advanced BIOS Features

Virus Warning <span style="float: right; color: yellow;">Disabled</span> CPU Internal Cache <span style="float: right; color: yellow;">Enabled</span> External Cache <span style="float: right; color: yellow;">Enabled</span> Swap Floppy Drive <span style="float: right; color: yellow;">Disabled</span> Boot Up Floppy Seek <span style="float: right; color: yellow;">Enabled</span> Boot Up NumLock Status <span style="float: right; color: yellow;">ON</span> Gate A20 Option <span style="float: right; color: yellow;">Fast</span> Typematic Rate Setting <span style="float: right; color: yellow;">Disabled</span> x Typematic Rate (Chars/Sec) <span style="float: right; color: yellow;">6</span> x Typematic Delay (Msec) <span style="float: right; color: yellow;">250</span> Security Option <span style="float: right; color: yellow;">Setup</span> OS Select For DRAM > 64MB <span style="float: right; color: yellow;">Non-OS2</span> Report No FDD For WIN 95 <span style="float: right; color: yellow;">Yes</span>	Item Help <hr/> Menu Level ▶
---	---------------------------------

↑↓→: Move    Enter : Select    + / - / PU / PD : Value    F10 : Save    ESC : Exit    F1: General Help  
 F5 : Previous Values                      F6 : Fail - Safe Defaults                      F7 : Optimized Defaults

After you have completed the changes, press [Esc] key and follow the instructions on your screen to save your settings or exit without saving.

### 3-3.1 Virus Warning

	Setting	Description	Note
Virus Warning	Disabled	Allows you to choose the VIRUS warning feature for IDE Hard Disk boot sector protection. If this function is enabled and someone attempt to write data into this area, BIOS will show a warning message on screen and alarm beep.	Default
	Enabled		

### 3-3.2 Cache Memory Options

	Setting	Description	Note
CPU Internal Cache	Disabled		
	Enabled	Enables the CPU's internal cache.	Default
External Cache	Disabled		
	Enabled	Enables the external memory.	Default

### 3-3.3 Floppy Driver Settings

	Setting	Description	Note
Swap Floppy Drive	Disabled		Default
	Enabled	Changes the sequence of A and B drives.	

### 3-3.4 Boot Up Floppy Seek

	Setting	Description	Note
Boot Up Floppy Seek	Disabled	Seeks disk drives during boot up. Disabling speeds boot up.	
	Enabled		Default

### 3-3.5 Boot Up NumLock Status

	Setting	Description	Note
<b>Boot Up NumLock Status</b>	On	Puts numeric keypad in NumLock mode at boot-up.	Default
	Off	Puts numeric keypad in arrow key mode at boot-up.	

### 3-3.6 Gate A20 Options

	Setting	Description	Note
<b>Gate A20 Options</b>	Normal	Lets chipset control GateA20.	
	Fast	A pin in the keyboard controller controls GateA20.	Default

### 3-3.7 Typematic Settings

Typematic Settings	Setting	Description	Note
<b>Typematic Rate Setting</b>	Disabled	Keystrokes repeat at a rate determined by the keyboard.	Default
	Enabled	When enables , the typematic rate and typematic delay can be selected.	
The following [Typematic Rate] and [Typematic Delay] fields are active only if [Typematic Rate Setting] is set to [Enabled]			
<b>Typematic Rate</b>	6 (Char/sec)	Choose the rate at which a character is repeated when holding down a key.	Default
	8 (Char/sec)		
	10 (Char/sec)		
	12 (Char/sec)		
	15 (Char/sec)		
	20 (Char/sec)		
	30 (Char/sec)		
<b>Typematic Delay</b>	250 (msec)	Choose how long after you press a key down the character begins repeating.	Default
	500 (msec)		
	750 (msec)		
	1000 (msec)		

### 3-3.8 Security Option

Use this feature to prevent unauthorized system boot-up or use of BIOS Setup. The following table describes the security settings.

Security Option	Setting	Description
	System	Each time the system is booted, the password prompt appears.
	Setup	If a password is set, the password prompt only appears when you attempt to enter the BIOS Setup program.

#### Other Control Options

Other Control Options	Setting	Description	Note
<b>OS Select for DRAM&gt;64MB</b>	OS2	When using an OS2 operating system.	
	Non-OS2	When using another, non-OS2 operating system.	Default
<b>Report No FDD For WIN 95</b>	Yes	Windows will release IRQ line 6 (normally used by the Floppy Disk Drive) after you disable your on-board FDD and set this field to [Yes].	Default
	No	Windows will reserve INT 6 for your FDD, whether it is disabled or not.	

### 3-4 ADVANCED CHIPSET FEATURES



**Caution:** Change these settings only if you are already familiar with the Chipset.

The [Advanced Chipset Features] option changes the values of the chipset registers. These registers control the system options in the computer.

CMOS Setup Utility – Copyright ( C ) 1984-2000 Award Software  
 Advanced Chipset Features

System BIOS Cacheable	Disabled	Item Help
Video BIOS Cacheable	Disabled	Menu Level ▶
Memory Hole AT 15M- 16M	Disabled	
CPU Latency Timer	Enabled	
Delayed Transaction	Enabled	
AGP Graphics Aperture Size	64MB	
Use VGA BIOS in VBU Block	Enabled	

↑↓→: Move    Enter : Select    + / - / PU / PD : Value    F10 : Save    ESC : Exit    F1 : General Help  
 F5 : Previous Values    F6 : Fail - Safe Defaults    F7 : Optimized Defaults

After you have completed the changes, press [Esc] and follow the instructions on your screen to save your settings or exit without saving. The following table describes each field in the Advanced Chipset Features Menu and how to configure each parameter.

## CHIPSET FEATURES SETUP

CHIPSET FEATURES	Setting	Description	Note
System BIOS Cacheable	Disabled		Default
	Enabled	The ROM area F0000H-FFFFFH is cacheable.	
Video BIOS Cacheable	Disabled		Default
	Enabled	The video BIOS C0000H-C7FFFH is cacheable.	
Memory Hole At 15M-16M	Disabled		Default
	Enabled	Some interface cards will map their ROM address to this area. If this occurs, select [Enabled] in this field.	
CPU Latency Timer	Disabled	When enabled this item, the CPU cycle will only be deferred after it has been held in a "Snoop Stall" for 31 clocks and another ADS# has arrived. When disabled, the CPU cycle will be deferred immediately after the GMCH receives another ADS#.	Default
	Enabled		
Delayed Transaction	Disabled	The chipset has an embedded 32-bit posted write buffer to support delay transactions cycles. Select <i>Enabled</i> to support compliance with PCI specification version 2.1.	Default
	Enabled		
AGP Graphics Aperture Size	64MB	Select the size of Accelerated Graphics Port (AGP) aperture. The aperture is a portion of the PCI memory address range dedicated for graphics memory address space. Host cycles that hit the aperture range are forwarded to the AGP without any translation.	Default
	4MB,		
	8MB,		
	16MB, 32MB, 128MB, 256MB		
Use VGA BIOS in VBU Block	Disabled	If you do not make use of the onboard VGA function you can set this item to disabled, this way the VGA BIOS will not be copied into the bootblock.	Default
	Enabled		



### 3-5 INTEGRATED PERIPHERALS



**Caution:** Change these settings only if you are already familiar with the Chipset.

The [INTEGRATED PERIPHERALS] option changes the values of the chipset registers. These registers control the system options in the computer.

The following screen shows setup default settings.

CMOS Setup Utility – Copyright ( C ) 1984-2000 Award Software Integrated Peripherals			
On-Chip Primary PCI IDE	Enabled		Item Help
On-Chip Secondary PCI IDE	Enabled		
IDE Primary Master PIO	Auto		
IDE Primary Slave PIO	Auto		
IDE Secondary Master PIO	Auto		
IDE Secondary Slave PIO	Auto		
IDE Primary Master UDMA	Auto		
IDE Primary Slave UDMA	Auto		
IDE Secondary Master UDMA	Auto		
IDE Secondary Slave UDMA	Auto		
USB Controller	Enabled		
USB Keyboard Support	Disabled		
Init Display First	PCI Slot		
IDE HDD Block Mode	Enabled		
POWER ON Function	BUTTON ONLY		
x KB Power ON Password	Enter		
x Hot Key Power ON	Ctrl-F1		
Onboard FDC Controller	Enabled		
Onboard Serial Port 1	3F8/IRQ4		
Onboard Serial Port 2	2F8/IRQ3		
UART Mode Select	Normal		
x UR2 Duplex Mode	Half		
Onboard Parallel Port	378/IRQ7		
Parallel Port Mode	SPP		
x ECP Mode Use DMA	3		
Game Port Address	201		
Midi Port Address	330		
Midi Port IRQ	10		
↑↓→: Move    Enter: Select    + / - / PU / PD : Value    F10 : Save    ESC : Exit    F1: General Help F5 : Previous Values                      F6 : Fail - Safe Defaults                      F7 : Optimized Defaults			

The following tables describe each field in the INTEGRATED PERIPHERALS Menu and provide instructions on how to configure the IDE controls, FDC controls, and the onboard serial and parallel ports.

### 3-5.1 IDE Device Controls

IDE Controls	Setting	Description	Note
<b>On-Chip PCI IDE</b>	Disabled	Turn off the on-board IDE	
	Enabled	Use the on-board IDE	Default
<b>IDE</b> > Primary Master PIO > Primary Slave PIO > Secondary Master PIO > Secondary Slave PIO	mode 0-4	0 is the slowest speed 4 is the fastest speed	
	Auto	For better performance and stability, we suggest you use the Auto setting to set the HDD control timing.	Default
<b>IDE</b> >Primary Master UDMA >Primary Slave UDMA >Secondary Master UDMA >Secondary Slave UDMA	Disabled		
	Auto	Select Auto to enable Ultra DMA Mode support.	Default

### 3-5.2 Keyboard Controls

Keyboard Controls	Setting	Description	Note
<b>USB Controller</b>	Disabled		
	Enabled	Select <i>Enabled</i> if your system contains a Universal Serial Bus (USB) controller and you have USB peripherals.	Default
<b>USB Keyboard Support</b>	Disabled	Turn off the on-board IDE	Default
	Enabled	Use a USB keyboard	
<b>Init Display First</b>	PCI Slot	Choose which card – AGP	Default
	AGP	Display card or PCI VGA card – to initialize first.	

### 3-5.3 IDE HDD Block Mode

	Setting	Description	Note
<b>IDE HDD Block Mode</b>	Disabled		
	Enabled	Invokes multi-sector transfer instead of one sector per transfer. Not all HDDs support this function.	Default

### 3-5.4 Others Optional

	Setting	Description	Note
<b>POWER ON Function</b>	Password	Enables you to wake-up the system by entering a password at the keyboard.	
	HotKEY	You can wake-up the system by pressing the key combination of your choice (Ctrl-F1~F12).	
	Mouse Left	Enables waking up the system by pressing either the right or left mouse button.	
	Mouse Right	Enables waking up the system by pressing either the right or left mouse button.	
	BUTTON-ONLY	Disables the Wake-Up by Keyboard function.	Default
	Keyboard 98		

If [POWER ON Function] is set to [Password]

<b>KB Power ON Password</b>	Enter (your password)	Set the password that will wake-up your system.
-----------------------------	-----------------------	---

If [POWER ON Function] is set to [Hot Key]

<b>Hot Key Power ON</b>	Ctrl-F1~F12	Choose the key combination that will wake-up the system. [Ctrl-F1 to Ctrl-F12]
-------------------------	-------------	--

### 3-5.5 FDC Controls

FDC Controls	Setting	Description	Note
<b>Onboard FDC controller</b>	Disabled	Turn off the on-board floppy controller	
	Enabled	Use the on-board floppy controller	Default

### 3-5.6 Onboard Serial Ports

Onboard Serial Ports	Setting	Description	Note
<b>Onboard Serial Port 1 / Serial Port 2</b>	Disabled		
	3F8/IRQ4	Choose serial port 1 & 2's I/O address.	Default (port 1)
	2F8/IRQ3	Do not set port 1 & 2 to the same address except for	Default (port 2)
	3E8/IRQ4	Disabled or Auto.	
	2E8/IRQ3		
	Auto		
<b>UART Mode Select</b>	Normal	The second serial port offers these InfraRed interface modes.	Default
	IrDA		
	ASKIR		
If [UART Mode Select] is set to [IrDA]/[ASKIR]			
<b>UR2 Duplex Mode</b>	Half	Choose [Half] or [Duplex] to set UR2 in half duplex mode or full duplex mode respectively. Refer to your IR device specifications to select the suitable mode.	Default
	Full		

### 3-5.7 Onboard Parallel Ports

Onboard Parallel Ports	Setting	Description	Note
<b>Onboard Parallel Port</b>	Disabled	Choose the printer I/O address.	
	378/IRQ7		Default
	3BC/IRQ7		
	278/IRQ5		
<b>Parallel Port Mode</b>	SPP	The mode depends on your external device that connects to this port.	Default
	EPP		
	ECP		
	ECP+EPP		
If [Parallel Port Mode] is set to [ECP] mode			
<b>ECP Mode use DMA</b>	3	Choose DMA3	Default
	1	Choose DMA1	



**3-5.8 Others Optional**

	Setting	Description	Note
<b>Game Port Address</b>	Disabled	Set the I/O base address for the ON board game port under this item.	
	201		Default
	209		
<b>Midi Port Address</b>	Disabled	Set the I/O address for the on board Midi port here.	Default
	330		
	300		
If [Midi Port Address] is set to [330]/[300] mode			
<b>Midi Port IRQ</b>	5	Select the IRQ that the Midi port uses under this them.	
	10		Default

### 3-6 POWER MANAGEMENT SETUP

The [POWER MANAGEMENT SETUP] sets the system's power saving functions.

CMOS Setup Utility – Copyright ( C ) 1984-2000 Award Software  
 Power Management Setup

ACPI Suspend Type      S1(POS) Power Management        User Define Video Off Method         DPMS Video Off In Suspend    Yes Suspend Type             Stop Grant MODEM Use IRQ         3 Suspend Mode            Disabled HDD Power Down         Disabled Soft-Off by PWR-BTTN   Instant-Off Wake-Up by PCI card    Disabled Power On by Ring        Enabled Resume by Alarm         Disabled x Date (of Month) Alarm   0 x Time (hh:mm:ss) Alarm   0  ** Reload Global Timer Events ** Primary IDE 0            Disabled Primary IDE 1            Disabled Secondary IDE 0         Disabled Secondary IDE1          Disabled FDD,COM, LPT Port      Disabled PCI PIRQ[A-D]#         Disabled	Item Help <hr/> Menu Level ▶
--	---------------------------------

↑↓→←:Move    Enter:Select    +/-/PU/PD:Value    F10:Save    ESC:Exit    F1:General Help  
 F5:Previous Values    F6:Fail-Safe Defaults    F7: Optimized Defaults

After you have completed the Power Management Setup, press [Esc] to return to the Main Menu.

### 3-6.1 Power Management Controls

Power Management Controls	Setting	Description			Note
<b>ACPI Suspend Type</b>	S1(POS)	The system will enter the S1 state during suspend. (Low latency wake up)			Default
	S3(STR)				
<b>Power Management</b>	User Define	Lets you define the HDD and system power down times.			Default
		Doze timer	Standby timer	Suspend timer	HDD power down
	Min Saving	1 Hour	1 Hour	1 Hour	15 Min
	Max Saving	1 Min	1 Min	1 Min	1 Min
<b>Video Off Method</b>	V/H Sync+Blank	Selects the method by which the monitor is blanked.			Default
	Blank screen				
	DPMS				
<b>Video Off In Suspend</b>	Yes	This determines the manner in which the monitor is blanked.			Default
	No				
<b>Suspend Type</b>	Stop Grant	The system can wake up through external events.			Default
	PwrOn Suspend	The system can only wake up through the Power-Button.			
<b>MODEM Use IRQ</b>	3	Assigns an IRQ# to the modem device.			Default
	3-11, NA				
<b>Standby Mode</b>	Disabled				Default
	1Min-1Hour	When the set time has elapsed, BIOS sends a command to the system to enter Standby Mode.			

**Power Management Controls (Continued)**

Power Management Controls	Setting	Description	Note
<b>HDD Power Down</b>	Disabled		Default
	1-15Min	When the set time has elapsed, BIOS sends a command to the HDD to power down. This turns off the HDD motor.	Some older model HDDs may not support this advanced function.
<b>Soft-Off by PWR-BTTN</b>	Instant-off		Default
	Delay 4 Sec.	Turns off the system power 4 seconds after pushing the power button.	
<b>Wake-Up by PCI card</b>	Disabled	If enabled any PCI interrupt will wake up the system.	Default
	Enabled		
<b>Power On by Ring</b>	Disabled		
	Enabled	The system will self-power on me when the modem is ringing.	Default
<b>Resume by Alarm</b>	Disabled	The system ignores the alarm.	Default
	Enabled	Set alarm to power on the system by the date (1-31) or time (hh:mm:ss). If the date is set to [0], the system will self-power on by alarm everyday at the set time.	



### 3-6.2 Reload Global Timer Events

Power Down & Resume Events	Setting	Description	Note
<b>IDE0, IDE1</b> ➤ Primary ➤ Secondary	Disabled		Default
	Enabled	In effect, the system remains alert for anything which occurs to a device which is configured as <i>Enabled</i> .	
<b>FDD, COM, LPT Port</b>	Disabled		Default
	Enabled	In effect, the system remains alert for anything which occurs to a device which is configured as <i>Enabled</i> .	
<b>PCI PIRQ [A-D]#</b>	Disabled		
	Enabled	The system monitors these elements for activity. The system will resume if [IRQ activity] is detected.	Default

### 3-7 PNP/PCI CONFIGURATION SETUP

This option sets the Motherboard's PCI Slots.

CMOS Setup Utility – Copyright ( C ) 1984-2000 Award Software  
 PnP/PCI Configurations

Reset Configuration Data	Disabled	Item Help <hr/> Menu Level ▶
Resources Controlled By x IRQ Resources	Auto (ESCD) Press Enter	
PCI/VGA Palette Snoop	Disabled	
Assign IRQ For VGA	Enabled	
Assign IRQ For USB	Enabled	
INT Pin 1 Assignment	Auto	
INT Pin 2 Assignment	Auto	
INT Pin 3 Assignment	Auto	
INT Pin 4 Assignment	Auto	

↑↓→←:Move    Enter:Select    +/ -/PU/PD:Value    F10:Save    ESC:Exit    F1:General Help  
 F5:Previous Values    F6:Fail-Safe Defaults    F7: Optimized Defaults



**Note:** Starred (\*) items will disappear when the [Resources Controlled By] option is set to [Auto].

After you have completed the PCI Slot Configuration, press [Esc] and follow the instructions on your screen to save your settings or exit without saving.

### 3-7.1 PNP/PCI Configuration Controls

PNP/PCI Controls	Setting	Description	Note
<b>Reset Configuration Data</b>	Disabled	Retain PnP configuration data in BIOS.	Default
	Enabled	Reset PnP configuration data in BIOS.	
<b>Resources Controlled By</b>	Manual	BIOS does not manage PCI/ISA PnP card IRQ assignment. Requires to assign IRQ-# and DMA-# to PCI or ISA PnP manually. IRQ-3,4,5,7,9,10,11,12,14,15 assigned to: _ DMA-0,1,3,5,6,7 assigned to: _	
	Auto (ESCO)	The Plug-and-Play BIOS auto manages PCI/ISA PnP card IRQ assignment automatically.	<b>Recommended</b>
If [Resources Controlled By] is set to [Manual]			
<b>IRQ-# and DMA-# assigned to:</b>	PCI/ISA PnP	Choose IRQ-# and DMA-# assigned to PCI/ISA PnP card.	IRQ-3,4,5,7,9,10,11,12,14,15 DMA-0,1,3,5,6,7
	Legacy ISA	Choose IRQ-# and DMA-# assigned to Legacy ISA card.	IRQ-3,4,5,7,9,10,11,12,14,15 DMA-0,1,3,5,6,7
Under this item the user can assign an IRQ to a PCI slot. However, there under some conditions the IRQ will not be assigned as selected under this item:			
<ol style="list-style-type: none"> <li>1. IRQs 0, 1, 2, 6, 8, 13 can NOT be assigned, because they are fixed.</li> <li>2. IRQs 5, 9, 10, 11 are available</li> <li>3. IRQs 3,4,7,12,14 and 15 will only be assigned if they are free. See the table below on how to free them:</li> </ol>			

## PNP/PCI Configuration Setup (Continued)

PNP/PCI Setup	Setting	Description	Note
Interrupt Line	How to set the BIOS to release the IRQ to the PnP Interrupt pool:		
	PnP / PCI configuration	Integrated Peripherals	
IRQ 15	IRQ 15: <b>PCI / ISA PnP</b>	On-Chip Secondary PCI IDE:	<b>disabled</b>
IRQ 14	IRQ 14: <b>PCI / ISA PnP</b>	On-Chip Primary PCI IDE:	<b>disabled</b>
IRQ 12	IRQ 12: <b>PCI / ISA PnP</b>	<i>Interrupt 12 will be released by the PnP BIOS automatically if the PS/2 Mouse Port is not used.</i>	
IRQ 7	IRQ 7: <b>PCI / ISA PnP</b>	Onboard parallel port:	<b>disabled</b>
IRQ 4	IRQ 4: <b>PCI / ISA PnP</b>	Onboard Serial port 1:	<b>disabled</b>
IRQ 3	IRQ 3: <b>PCI / ISA PnP</b>	Onboard Serial port 2:	<b>disabled</b>
4. Your OS may reassign another interrupt to a PCI slot after BIOS passes control to the OS, especially if you use Windows 95, 98 or NT.			
<b>Assign IRQ For VGA/USB</b>	Disabled	BIOS will assign IRQ for USB port.	
	Enabled	BIOS won't assign IRQ for USB port.	Default
5. Your OS may reassign another interrupt to a PCI slot after BIOS passes control to the OS, especially if you use Windows 95, 98 or NT.			
<b>INT Pin 1/2/3/4 Assignment</b>	Auto	Set to Auto the BIOS will using IRQs Automatically.	Default

### 3-7.2 MULTI I/O ADDRESSES

Default settings for multi-I/O addresses are as follows:

Port	I/O Address	IRQ	Status
<b>LPT1</b>	378H	7	ECP/EPP
<b>COM1</b>	3F8H	4	
<b>COM2</b>	2F8H	3	



**Warning:** If a default I/O address conflicts with other I/O cards such as sound card, you must change one of the I/O addresses to remedy to this address conflict. (I/O addresses can be adjusted from the BIOS Setup Utility)

### 3-8 PC HEALTH STATUS

This option sets the Motherboard's PC Health Status.

CMOS Setup Utility – Copyright ( C ) 1984-2000 Award Software  
 PC Health Status

Shutdown Temperature <b>Disabled</b> Vcore    1.58 V VTT    1.45 V 3.3V     3.36 V +12V     11.90 V VBAT (V)                                       3.07 V CPU Temperature                              85°C System Temperature                          31°C CPUFAN Speed                                5192 RPM CHAFAN Speed                                0 RPM SYSFAN Speed                                0 RPM	Item Help <hr/> Menu Level ▶
---	---------------------------------

↑↓→←:Move    Enter:Select    +/-/PU/PD:Value    F10:Save    ESC:Exit    F1:General Help  
 F5:Previous Values                      F6:Fail-Safe Defaults                      F7: Optimized Defaults



**Note:** Starred (\*) items will disappear when the [Resources Controlled By] option is set to [Auto].

### 3-8.1 CPU Device Monitoring

CPU Device Monitoring	Setting	Description	Note
<b>Shutdown Temperature</b>	Disabled	This item allows you to set up the CPU shutdown Temperature. This item only effective under Windows 98 ACPI mode.	Default
	60°C/140°F, 65°C/149°F, 70°C/159°F, 75°C/167°F, 80°C/176°F, 85°C/185°F, 90°C/194°F, 95°C/203°F, 100°C/212°F, 110°C/230°F		
<b>Vcore, VTT, 3.3V, +12V, VBAT</b>	V	Show the current voltage status.	
<b>CPU Temperature</b>	°C/°F	Show the current status of CPU temperature.	
<b>System CPU Temperature</b>	°C/°F	Show the current status of the system temperature.	
<b>CPUFAN Speed</b>	RPM	Show you the current CPUFAN operating speed.	
<b>CHAFAN Speed</b>	RPM	Show you the current CHAFAN operating speed.	
<b>SYSFAN Speed</b>	RPM	Show you the current SYSFAN operating speed.	

### 3-9 LOAD FAIL-SAFE DEFAULTS

Select the [Load Fail-Safe Defaults] option from the Main Menu to load the system values you have previously saved. This option is recommended if you need to reset the system setup and to retrieve the old values.

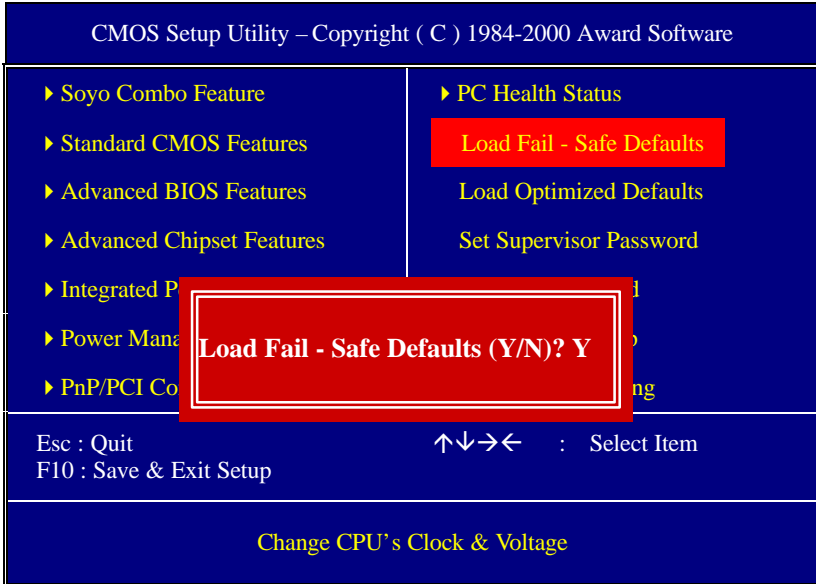

Type [Y] to use the Setup Defaults followed by [Enter] or otherwise [N] to return to the Main Menu and keep current values.



**Warning:** If you run into any problem after changing the BIOS configuration, please load the SETUP DEFAULTS for stable performance.

### 3-10 LOAD OPTIMIZED DEFAULTS

Select the [Load Optimized Defaults] option from the Main Menu to load the system values you have previously saved. This option is recommended if you need to reset the system setup and to retrieve the old values.

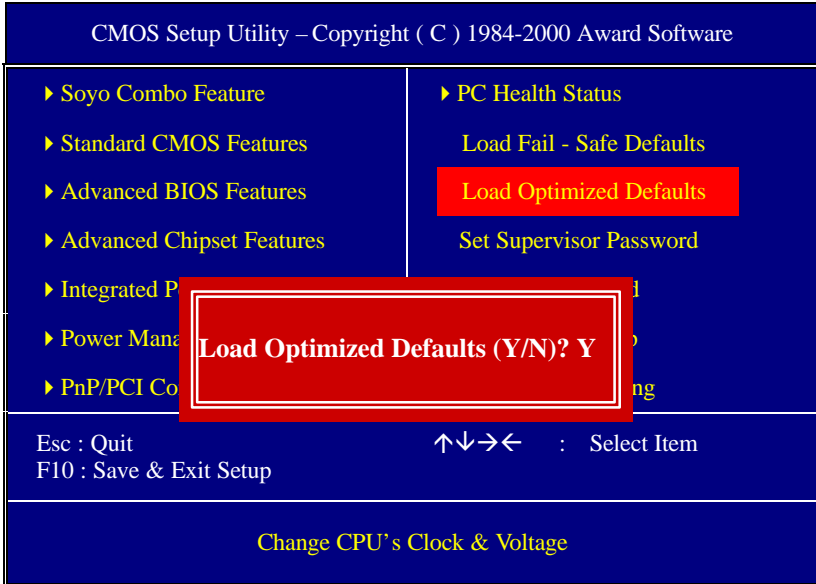

Type [Y] to use the Setup Defaults followed by [Enter] or otherwise [N] to return to the Main Menu and keep current values.



**Warning:** If you run into any problem after changing the BIOS configuration, please load the SETUP DEFAULTS for stable performance.



### 3-11 SUPERVISOR PASSWORD

Based on the setting you have made in the [Security Option] of the [BIOS FEATURES SETUP] section, the password prevents access to the system or the setup program by unauthorized users. Follow this procedure to set a new password or disable the password:

1. Choose [BIOS FEATURES SETUP] in the Main Menu and press [Enter]. Select the [Security Options] item and set the field to:
  - a. [System]: The password is required every time the system is booted. This means only a person who knows the password can use this computer.
  - b. [Setup]: The password is required only when you attempt to enter the BIOS Setup program.
2. Choose [SUPERVISOR PASSWORD] from the Main Menu and press [Enter]. The following prompt appear:

Enter Password:



---

**Warning:** If you forget or lose the password, the only way to access the system is to set jumper JP5 to clear the CMOS RAM. All setup information is lost and you must run the BIOS setup program again.

---



---

**Note:** If you do not wish to use the password function, press [Enter] directly and the following message appears:

Password Disabled!!

---

3. Enter your new password and press [Enter]. The following message appears, prompting to confirm the new password:

Confirm Password:

4. Re-enter your password and then press [Enter] to exit to the Main Menu.

This diagram outlines the password selection procedure:

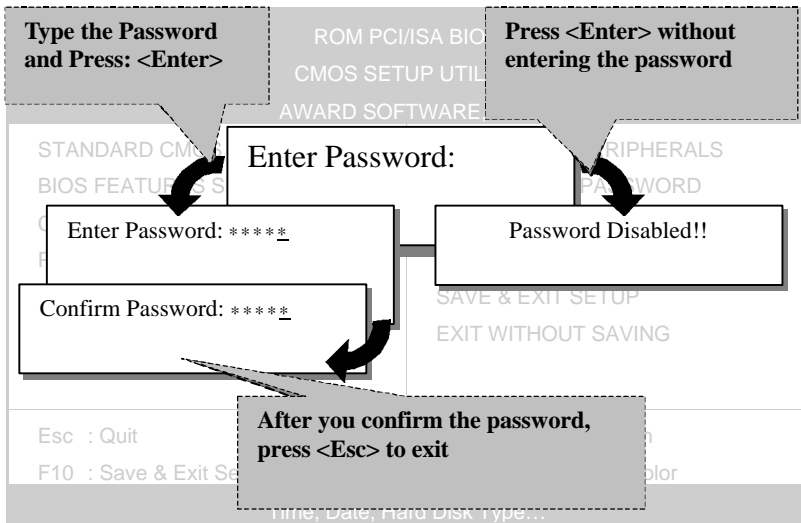

### 3-12 USER PASSWORD

When the user password option is on, you are not allowed to change any setting in the [CMOS SETUP UTILITY] except for changing the user's password.

The password setting procedure is similar to that for the [SUPERVISOR PASSWORD] (Refer to section 3-9).

### 3-13 IDE HDD AUTO DETECTION

This Main Menu function automatically detects the hard disk type and configures the [Standard CMOS Features] accordingly.

CMOS Setup Utility – Copyright ( C ) 1984-2000 Award Software  
 IDE Primary Master

IDE HDD Auto-Detection <b>Press Enter</b>  IDE Primary Master <b>Auto</b>  Capacity                      0 MB Access Mode <b>Auto</b> 0 Cylinder                      0 Head                            0 Precomp                        0 Landing Zone                0 Sector                            0	Item Help  Menu Level ▶
---	-------------------------------

↑↓→←:Move    Enter:Select    +/-/PU/PD:Value    F10:Save    ESC:Exit    F1:General Help  
 F5:Previous Values        F6:Fail-Safe Defaults        F7: Optimized Defaults



**Note:** This function is only valid for IDE type of hard disk drives.

## Boot Menu

Boot Menu enables user to boot-up on different boot device without going into the BIOS setup.

*To enable boot Menu, press “ESC” after memory initialization, user will see a device menu, in which user can choose on which device they wish to boot from.*

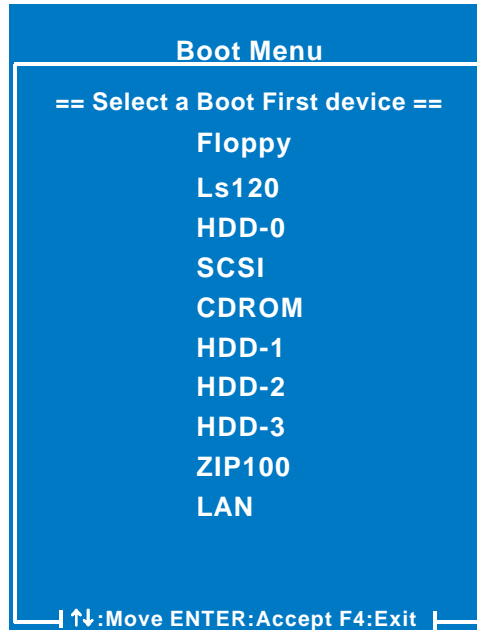

## Chapter 4

### THE SOYO CD



**The SOYO-CD will NOT autorun if you use it on an Operating System other than Windows 9x or NT.**

Your SY-7ISA+ Motherboard comes with a CD-ROM labeled "SOYO CD." The SOYO CD contains (1) the user's manual file for your new Motherboard, (2) the drivers software available for installation, and (3) a database in HTML format with information on SOYO Motherboards and other products.

**Step 1.** Insert the SOYO CD into the CD-ROM drive  
The SOYO CD will auto-run, and the SOYO CD Start Up Menu will be as shown.

If you use Windows NT, the SOYO-CD will not detect your motherboard type. In that case the following dialog will pop up, please choose your motherboard and press OK. Now the SOYO-CD Start Up Menu will be shown.

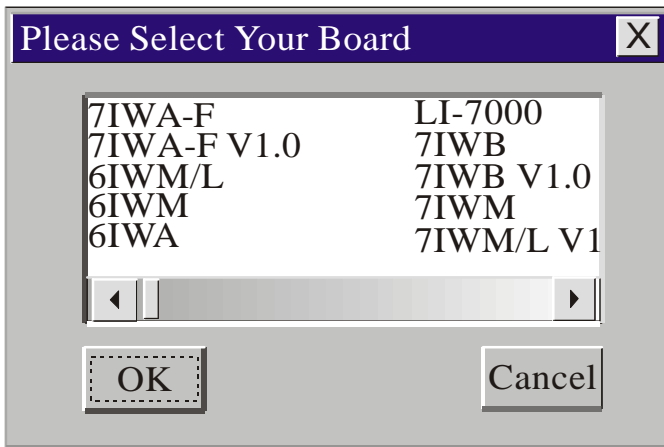

(SOYO CD Start Up Program Menu)

If you use Windows 95 or 98, the SOYO CD Start Up Program automatically detects which SOYO Motherboard you own and displays the corresponding model name.



The user's manual files included on the SOYO CD are in PDF (Postscript Document) format. In order to read a PDF file, the appropriate Acrobat Reader software must be installed in your system.

**Note:** The Start Up program automatically detects if the Acrobat Reader utility is already present in your system, and otherwise prompts you on whether or not you want to install it. You must install the Acrobat Reader utility to be able to read the user's manual file. Follow the instructions on your screen during installation, then once the installation is completed, restart your system and re-run the SOYO CD.

**Step 2.** Install Drivers and Utilities

Click the **Install Drivers** button to display the list of drivers software that can be installed with your Motherboard. The Start Up program displays the drivers available for the particular model of Motherboard you own. We recommend that you only install those drivers.

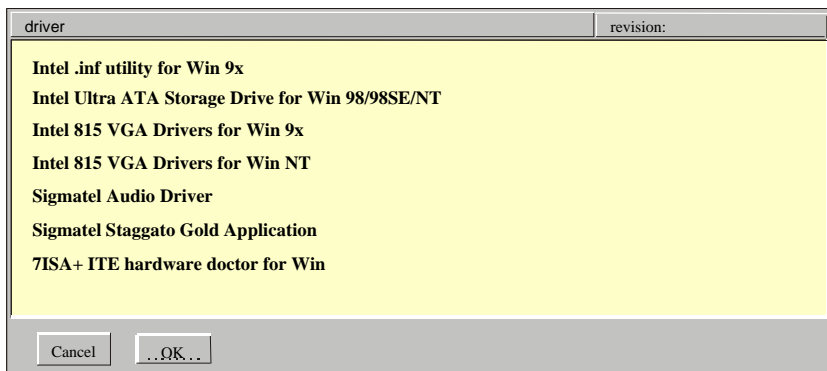
**(Driver Installation Menu)**

**A short description of all available drivers follows:**

➤ **Intel .inf utility for Win 9x**

Windows 95 and 98 will not recognize the new INTEL 815 chipset properly. To update the necessary .inf files that will help Windows recognize the 815 chipset, please run this utility.

➤ **Intel Ultra ATA Storage Driver for Win 98/98SE/NT**

The Intel® Ultra ATA Storage Driver automatically enables fast Ultra ATA transfers for a variety of ATA/ATAPI mass storage devices such as hard disk drives and CD-ROMs.

➤ **Intel 815 VGA Drivers for Win9x**

In order to be able to make use of the integrated VGA function in your Intel 815 chipset, you will need to install this driver first. For Windows 95/98 only.

➤ **Intel 815 VGA Drivers for NT 4.0**

In order to be able to make use of the integrated VGA function in your Intel 815 chipset, you will need to install this driver first. For NT 4.0 only.

➤ **Sigmatel Audio Driver**

This AC codec sound driver is for Windows 9x, 2000 and NT.

➤ **Sigmatel Staggato Gold Application**

This application contains the wavetable that is necessary to play MIDI files. Make sure to install it after installing the Sigmatel drivers for your OS.

(Refer to the manual installation guide in the back.) This application is suitable for Windows 95, 98(SE) and NT.

➤ **7ISA+ ITE hardware doctor for Win 9X/2000/NT**

Your motherboard comes with a hardware monitoring IC. By installing this utility Temperature, Fan speed and Voltages can be monitored. It is also possible to set alarms when current system values exceed or fall below pre-set values.

Select which driver you want to install and click **OK**, or click **Cancel** to abort the driver installation and return to the main menu.

**Note:** Once you have selected a driver, the system will automatically exit the SOYO CD to begin the driver installation program. When the installation is complete, most drivers require to restart your system before they can become active.

**Step 3.** Check the Latest Releases

Click the 'Check the latest Releases' button to go the SOYO Website to automatically find the latest BIOS, manual and driver releases for your motherboard. This button will only work if your computer is connected to the internet through a network or modem connection. Make sure to get your modem connection up before clicking this button.



## Chapter 5

### **SIGMATEL AUDIO DRIVER INSTALLATION**

*Installing the Sigmatel Audio Drivers under windows 95/98, Windows 98 Second Edition, Windows 2000 and Windows NT*

You have to install the drivers before installing any application for the AC97 codec.

*Uninstalling/Re-Installing Sigmatel Audio Drivers for Windows 9x*

1. Open Device Manager.
2. Remove the Sigmatel Audio Codec entry in the Sound, Video, and Game Controllers section. Do not change the game controller in this audio solution.
3. Delete the sigmatel INF file in c:\windows\inf\other
4. Restart your PC for Plug and Play to reinitialize your system.

*Uninstalling or Updating the Sigmatel Audio Drivers for Windows NT*

1. Double click on the MULTIMEDIA icon in the control panel. Select the Devices tab from the Multimedia properties window.
2. Double click on the Audio Devices entry from the Multimedia devices list. Select the driver by placing the mouse pointer over the sigmatel driver label and clicking the left mouse button.
3. Press the REMOVE button.
4. A question box will appear to verify your decision. Press the YES button.

Windows NT will display a dialog box asking you to restart your system. Press the Restart Now button to complete the Un-installation

## SynthCore Lite Application for Windows NT 4.0

The CD contains a SynthCore Lite application program, that the Quick Start Guide does not describe. It can be installed by running StacGold.exe in the D:\drive-all\sigmatel\StacGold directory. (Were D is your CD-ROM drive letter).

***Note that the NT4 installation requires a manual step at the end of the installation. This step applies to NT4 only. (NT4 Service Pack 4 has to be installed, Service Pack 4 includes DirectSound 3)***

- 1) After you run the normal installer, DO NOT reboot your system yet.
  - 2) Go to Start > Settings > Control Panel > Multi Media
  - 3) Select the "Devices" tab
  - 4) Select the "Add" Button
  - 5) Select "Unlisted or Undated Driver"
  - 6) Browse to c:\Program Files\Staccato\SynthCore Lite\oemsetup.inf and select this file.
  - 7) Now look under the MIDI Devices tab, you should see the Staccato MIDI driver.
  - 8) Reboot your machine.
- This finishes the installation process.

## Chapter 6

# INTEL 815 VGA DRIVERS INSTALLATION (For Windows 2000)

### INSTALLING THE SOFTWARE General Installation Notes:

1. The operating system must be installed on the system prior to installation.
2. This installation procedure is specific only to the version of driver and installation file included in this release.
3. This procedure assumes that all of the software associated with this release is located in the same directory.

### MANUAL INSTALL FROM HARD DRIVE

1. Download WIN2KCD.ZIP from the Web. Double-click to unzip. (You must have WinZip\* installed; download it from [www.winzip.com](http://www.winzip.com)). Hit the Extract button and indicate the directory into which the files are to be extracted. Hit the Extract button to unzip the files to that directory. If you wish to install from the CD-ROM, then the files must be transferred to a CD.
2. Select the My Computer icon.
3. Select the Control Panel icon.
4. Select the System icon.
5. You should be in the System Properties window.
6. Click on the Hardware tab.
7. Click the Device Manager button.
8. Click the Display Adapters selection.

9. The current list of adapters is displayed.
10. Click on the adapter (e.g., VGA) that the Intel Win2K driver is replacing.
11. Click on the Driver tab.
12. Click the Update Driver... button.
13. The Upgrade Device Driver Wizard window should now open.
14. Click the Next button.
15. Select the following option: "Display a list of the known drivers for this device so that I can choose a specific driver".
16. Click the Have Disk button.
17. Click on "Browse" and go to the directory where the files were unzipped. Go to the Win2K directory. If the English version of the driver is to be installed, select the i81xnt5.INF file and press OK. If another language is desired, select the INF folder, and then select the INF file of the desired language.
18. Proceed according to the remaining prompts. Close all windows and reboot in order to use the new driver. See "Verifying the Installation of the Software" below to confirm that the proper driver is being used.

## VERIFYING THE INSTALLATION OF THE SOFTWARE

1. From the Microsoft Windows 2000 desktop, click on "My Computer", then "Control Panel", and then "System".
2. You should be in the System Properties window. Click on the Hardware tab and hit the Device Manager button. From here, go down to "Display Adapter" and click.
3. The installed display adapter should be Intel Corporation 815 Graphics Controller Hub.

