



SY-K7ADA

Motherboard

AMD[®] Athlon/Duron[™]

Processor supported

ALI MAGIK1 AGP/PCI Motherboard

266/200 MHz Front Side Bus supported

ATX Form Factor

User's Manual

Copyright © 2001 bySoyo Computer Inc.

Trademarks:

Soyo is the registered trademark of Soyo Computer Inc. All trademarks are the properties of their owners.

Product Rights:

All names of the product and corporate mentioned in this publication are used for identification purposes only. The registered trademarks and copyrights belong to their respective companies.

Copyright Notice:

All rights reserved. This manual has been copyrighted by Soyo Computer Inc. No part of this manual may be reproduced, transmitted, transcribed, translated into any other language, or stored in a retrieval system, in any form or by any means, such as by electronic, mechanical, magnetic, optical, chemical, manual or otherwise, without permission in writing from Soyo Computer Inc.

Disclaimer:

Soyo Computer Inc. makes no representations or warranties regarding the contents of this manual. We reserve the right to amend the manual or revise the specifications of the product described in it from time to time without obligation to notify any person of such revision or amend. The information contained in this manual is provided to our customers for general use. Customers should be aware that the personal computer field is subject to many patents. All of our customers should ensure that their use of our products does not infringe upon any patents. It is the policy of Soyo Computer Inc. to respect the valid patent rights of third parties and not to infringe upon or to cause others to infringe upon such rights.

Restricted Rights Legend:

Use, duplication, or disclosure by the Government is subject to restrictions set forth in subparagraph (c)(1)(ii) of the Rights in Technical Data and Computer Software clause at 252.277-7013.

About This Guide:

This Quick Start Guide can help system manufacturers and end users in setting up and installing the Motherboard. Information in this guide has been carefully checked for reliability; however, to the correctness of the contents there is no guarantee given. The information in this document is subject to amend without notice.

For further information, please visit our **Web Site** on the Internet. The address is "<http://www.soyo.com.tw>".

Edition: May 2001
Version 1.2
K7ADA SERIAL

FC Tested To Comply
With FCC Standards
FOR HOME OR OFFICE USE

100% POST CONSUMER
RECYCLED PAPER

Table of Contents

CHAPTER 1 MOTHERBOARD DESCRIPTION.....	1
1-1 INTRODUCTION	1
1-2 KEY FEATURES	1
1-3 ELECTROSTATIC DISCHARGE PRECAUTIONS	4
1-4 SY-K7ADA MOTHERBOARD LAYOUT	5
1-5 SY-K7ADA MOTHERBOARD COMPONENTS	6
1-6 MICROPROCESSOR.....	8
1-7 CHIPSET	9
1-8 HARDWARE MONITOR.....	12
1-9 WAKE ON LAN TECHNOLOGY.....	13
CHAPTER 2 HARDWARE INSTALLTION.....	14
2-1 PREPARATIONS	14
2-2 UNPACKING THE MOTHERBOARD	15
2-3 INSTALLATION GUIDE	16
2-3.1 CPU Installation.....	17
2-3.2 DDR SDRAM Memory Module Installation	20
2-3.3 Motherboard Connector.....	22
2-3.4 Jumper Setting	36
2-3.5 The synchronous/asynchronous clock mode between CPU and memory interface setting.....	38
2-3.6 CPU Vcore adjustment (VJ1).....	38
2-3.7 CMOS Clearing (JP5).....	39
2-3.8 Power On.....	40
2-3.9 Quick BIOS Setup	41
2-3.10 Troubleshooting at First Start.....	42
2-3.11 Power Off.....	45
CHAPTER 3 BIOS SETUP UTILITY.....	46
3-1 SOYO COMBO SETUP	49

3-2	ADVANCED BIOS FEATURES.....	54
3-3	ADVANCED CHIPSET FEATURES.....	59
3-4	INTEGRATED PERIPHERALS	62
3-5	POWER MANAGEMENT SETUP	66
3-6	PNP/PCI CONFIGURATION SETUP.....	70
3-7	PC HEALTH STATUS.....	73
3-8	LOAD FAIL-SAFE DEFAULTS.....	75
3-9	LOAD OPTIMIZED DEFAULTS.....	76
3-10	SUPERVISOR PASSWORD.....	77
3-11	USER PASSWORD.....	78
3-12	IDE HDD AUTO DETECTION	79
3-13	BOOT MENU	80
CHAPTER 4 DRIVER INSTALLATION.....		81

Chapter 1

MOTHERBOARD DESCRIPTION

1-1 INTRODUCTION

The **SY-K7ADA** AGP/PCI Motherboard is a high-performance Socket 462 ATX form-factor system board. Using ALI Chipset technology. This Motherboard is fully compatible with industry standards and adds many technical enhancements.

1-2 KEY FEATURES

➤ CPU SUPPORT

The SY-K7ADA supports THE FOLLOWING AMD® CPUs:

- Supports 200MHz Front Side Bus DDR(Double Data Rate) transfer on Athlon(750MHz~1.2GHz)/ Duron™(600MHz~850MHz)
- Supports 266MHz Front Side Bus DDR (Double Data Rate) transfer on Athlon(1GHz~1.2GHz)

New released AMD Socket 462 CPUs will very likely be supported by the SY-K7ADA as well.

➤ CPU SETTINGS

The SY-K7ADA provides the user with a very complete and convenient CPU setting environment. The CPU settings are all adjusted through the DIP switch.

■ CPU Frequency

The SY-K7ADA supports an incredible wide range of CPU frequency settings:

600,650,700,750,800,850,900,950,1000+MHz.

This gives the SY-K7ADA an overwhelming overclocking potential.

- **CPU Multiplier**

➤ **EXPANDABILITY**

The SY-K7ADA provides all the standard expansion slots, and many more additional expansion features:

- ◆ **Expansion slots**

- 1 x 32-bit bus master AGP slot
- 5 x 32-bit bus master PCI slots

- ◆ **Enhanced IO**

- Floppy disk controller
- 2x EIDE controllers with support for up to 4 Ultra DMA 33/66/100 devices
- Standard/EPP/ECP parallel port
- 2x 16550 compatible serial ports
- IrDA compatible infrared port
- 6x USB (Universal Serial Bus) connectors
- PS/2 mouse connector
- PS/2 keyboard connector

➤ **ADVANCED FUNCTIONS**

The SY-K7ADA supports advanced functions such as:

■ **Wake-On-LAN**

Supports Wake-On-LAN (*Some advanced network cards can wake the system up over the network, the WOL connector is provided by the SY-K7ADA to support this function*).

■ **Multiple boot**

The SY-K7ADA supports booting from devices such as CD-ROM, FLOPPY DRIVE & HDD, LS120, SCSI, ZIP.

■ **Power on by modem or alarm**

If the SY-K7ADA system is in suspend mode, it can be switched back on through the modem or RTC alarm function. This opens a lot of possibilities, such as remote access that switches the system on only after the modem receives a call.

➤ **FAIL SAFE**

The SY-K7ADA comes with added functionality to make managing the system easy and safe

◆ **Hardware Monitor**

The integrated Hardware Monitor IC and Hardware doctor software enables the user to monitor system voltages, temperatures and FAN speeds. This makes sure that the user is in full control of the system

➤ **SOYO Bonus Pack CD-ROM**

➤ **COMPLIANCE**

The SY-K7ADA complies with all important industry standards. The following underlines the reliability of the SY-K7ADA, a motherboard to trust.

■ **PC99, ACPI compliant**

➤ **USER FRIENDLY**

■ **SOYO Combo Setup**

■ **Jumperless design**

■ **You can set up the following options through the BIOS setup**

- CPU FSB frequency
- PCI clock
- AGP Clock
- SDRAM Clock

➤ **HANDLING THE MOTHERBOARD**

To avoid damage to your Motherboard, follow these simple rules while unpacking:

- Before handling the Motherboard, ground yourself by grasping an unpainted portion of the system's metal chassis.
- Remove the Motherboard from its anti-static packaging. Hold the Motherboard by the edges and avoid touching its components.
- Check the Motherboard for damage. If any chip appears loose, press carefully to seat it firmly in its socket.



Warning: Do not apply power if the Motherboard appears damaged. If there is damage to the board, contact your dealer immediately.

1-3 ELECTROSTATIC DISCHARGE PRECAUTIONS

Make sure to ground yourself before handling the Motherboard or other system components. Electrostatic discharge can easily damage the components. Note that you must take special precautions when handling the Motherboard in dry or air-conditioned environment.

To protect your equipment from electrostatic discharge, take the following precautions:

- Do not remove the anti-static packaging until you are ready to install.
- Ground yourself before removing any system component from its protective anti-static packaging. (To ground yourself, grasp the expansion slot covers or other unpainted portions of the computer chassis.)
- Frequently ground yourself while working or use a grounding strap.
- Handle the Motherboard by its edges and avoid touching its components.

1-4 SY-K7ADA MOTHERBOARD LAYOUT

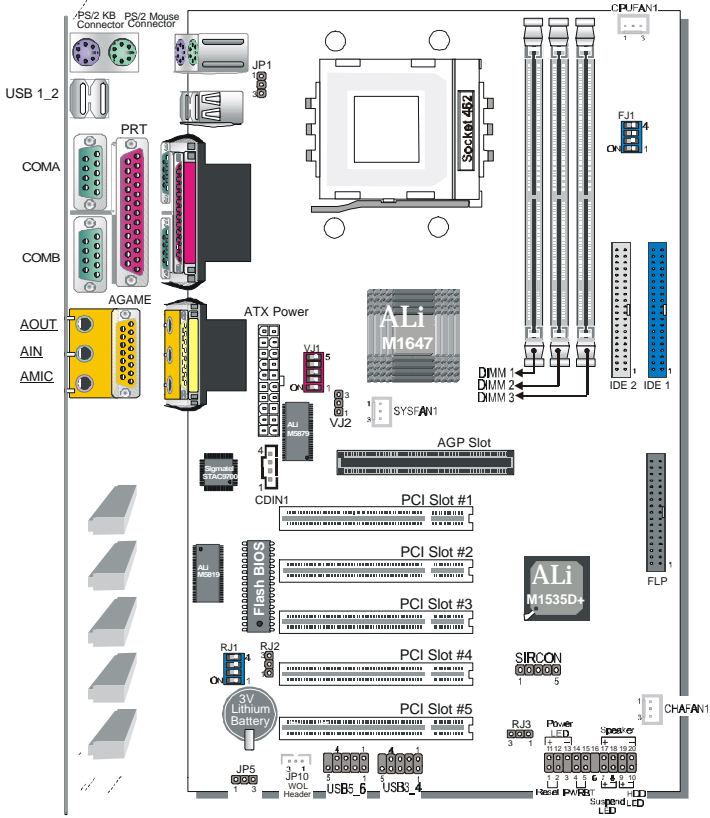

Back Panel

SY-K7ADA Platform

1-5 SY-K7ADA MOTHERBOARD COMPONENTS

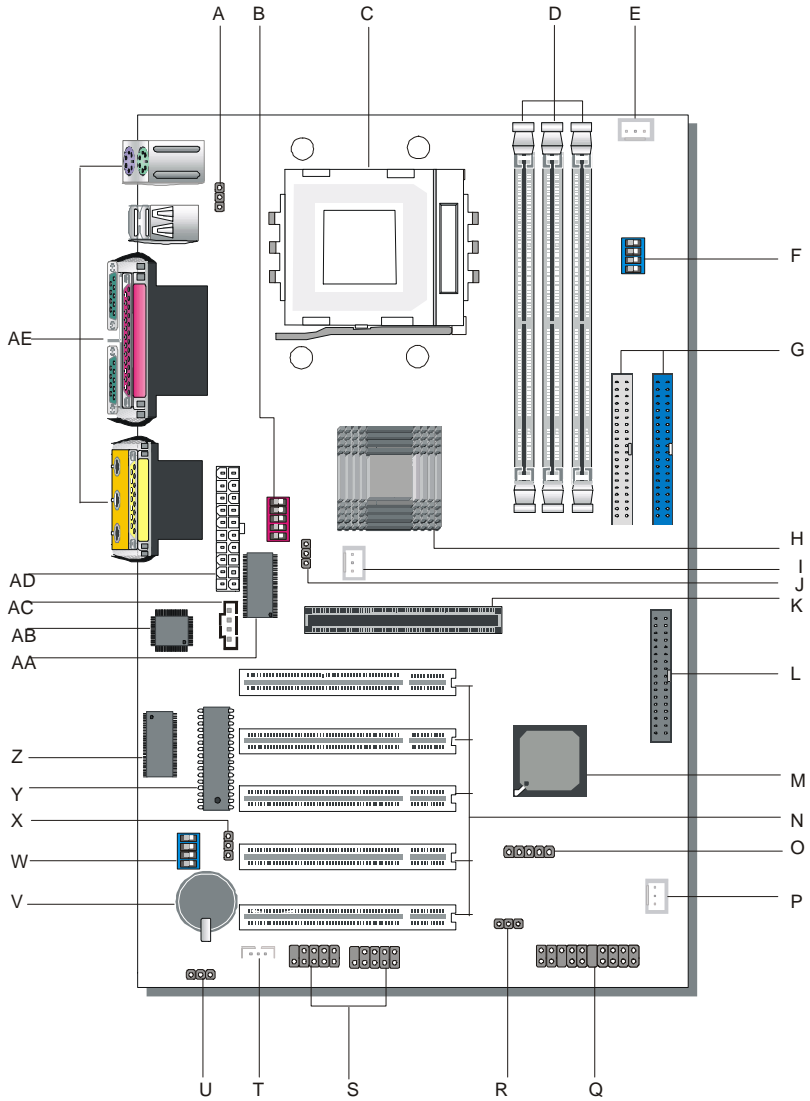

- A K/B Power-On setting Jumper**
- B CPU Vcore adjustment setting switch**
- C Socket 462 Connector**
- D DIMM Banks**
- E CPU Cooling Fan Connector**
- F CPU FSB adjustment setting switch**
- G Bus Mastering E-IDE/ATAPI Ports**
- H ALi M1647 North Bridge chip**
- I SYS Cooling Fan**
- J CPU Vcore setting Jumper**
- K 32-bit AGP 1X/2X/4X Slot**
- L Floppy Disk Drive (FDD) Port**
- M ALi M1535D+ South Bridge chip**
- N 32-bit PCI Mastering Slots**
- O Serial Infrared (IrDA) Device Header**
- P Chassis Cooling Fan**
- Q Front panel Connectors**
- R CPU Multiplier setting Jumper**
- S USB3_4 and USB 5_6 Connectors**
- T Wake-On-LAN (WOL) Header**
- U CMOS Clear Jumper**
- V 3V Lithium Battery**
- W CPU Multiplier adjustment setting switch**
- X CPU Multiplier setting Jumper**
- Y Flash BIOS**
- Z R.T.C. and CMOS RAM**
- AA Hardware Monitor**
- AB Sigmatel STAC9700 Chip**
- AC CD In Connector**
- AD ATX Power Supply Connector**
- AE Back panel Connectors**

1-6 MICROPROCESSOR

The motherboard supports a single Socket 462 processor. The processor's VID pins automatically program the voltage regulator on the motherboard to the required processor voltage. In addition, the front side bus speed (200/266 MHz) is automatically selected. The motherboard supports all current Socket 462 processor speeds, voltages, and bus frequencies.

1-6.1 Microprocessor Packaging

The CPU is packaged in a 462 pin PGA package. A fan must be used to ensure adequate cooling.

1-6.2 Second Level Cache

The second-level cache is located on the substrate of the CPU package. The cache includes Athlon-256KB / Duron-64KB of synchronous pipelined burst static RAM. All supported onboard memory can be cached.

1-6.3 Microprocessor Upgrades

The motherboard can be upgraded with Socket 462 processors that run at higher speeds. When upgrading the processor, use the BIOS configuration mode or DIP switch to change the processor speed.

1-7 CHIPSET

➤ ALi M1647 Overview

The M1647 is a high performance, high value North Bridge that supports all Athlon family processors. Internally all 128-bit architecture with optimization for S2K bus, DDR and AGP4X interface, the M1647 has outstanding high system performance under all types of system operations. The M1647 North Bridge, coupled with one of ALi's widely adopted PCI South Bridge devices (M1535D+) provides a flexible and scalable motherboard core logic solution to fill all applications.

The M1647 supports all Athlon family microprocessors. Processor bus speeds of 66MHz to 133MHz are supported. This interface has 16 entries for outstanding processor commands and system probe commands. This interface supports FID change protocol for mobile purposes.

The M1647 can support up to 3.0 GB of SDRAM or DDR-SDRAM main memory. Supports any combination of 66/100/133MHz memory bus frequency and CPU bus frequency with minimized internal protocol handshaking overhead, the M1647 provides a flexible system application. In addition to dynamic memory power down, the M1647 also supports a dynamic gated clock for the internal chipset logic circuitry, which will reduce the system power consumption for mobile applications. The m1647 support the CAS-before-RAS refresh scheme and Self-refresh scheme during normal mod and suspend mode, respectively.

The memory access controller plays a key role of dispatching the job to the memory interface. By using a two-level dynamic arbitration scheme, the M1647 fulfills multiple demanding sources that need access to the main memory with balanced latency and maximum throughput. Another important role of the memory access controller is the integration logic between the AGP interface and main memory to support the AGP memory address to physical memory address translate. To fulfill this function, the M1647 uses 128 entries and 16 tags to implement a one level GART (Graphic Address Re-mapping Table) scheme.

The M1647 supports all features of the AGP version 2.0 specification.

This boosts the graphic benchmarks into another era for professional graphics usage. The M1647 design is capable of supporting 28 outstanding AGP commands (depth of command queue=28) and buffering 64QW for AGP master read operations.

The M1647 is fully compliant with the PCI 2.2 specification. Flexible PCI latency control allows the M1647 to achieve improved system performance.

The M1647 PCI host interface features a flexible PCI latency controller that allows a system to be tuned for the best system performance possible. The m1647 also features an enhanced PCI arbiter that implements a fair arbitration scheme based on a PCI and time slice mechanism. In addition to itself and the South Bridge, the M1647 can support up to six addition PCI masters. This gives designers the ultimate in flexibility when deciding what combination of PCI slots and on board PCI peripheral devices to use. One of these six PCI master channel can be assigned to a higher priority than other five PCI masters in order to fulfill the demands of some special real time devices, e.g. 1394 isochronous transmissions, when accessing main memory.

Dark Green Power Management functions such as Power on Suspend, Suspend to RAM, Suspend to Disk, PCI bus CLKRUN and Dynamic Clock Stop are all supported. The M1647 provides the most flexible power management capability available in any chipset.

➤ **ALi M1535D+ Overview**

The M1535D+ provides the best desktop system solution. The M1535D+ integrates AC-Link Host Controller, Hardware SoundBlaster Pro/16 compatibility, Host Signal Processing (HSP) software modem solution, ACPI support, green function, 2-channel dedicated ATA-100 IDE Master controller, 2 USB controllers, SMBus controller, PS/2 Keyboard/Mouse controller, the Super I/O (Floppy Disk Controller, 2 serial port/1 parallel port) support and Fast IR into one chip.

The built-in I/O in M1535D+ is an advanced Super I/O controller containing all of the basic IBM PC, XT, AT peripherals. It incorporates

three full function universal asynchronous receiver/transmitters (UARTs), a flexible high performance internal data separator with send/receive 16 byte FIFOs. It is also suitable for notebook computers since it has Fast Infra Red for wireless communications with other devices. It can swap the floppy drives A & B. It supports SPP, PS/2, EPP and ECP parallel port. It also has a programmable baud rate generator. It has high performance power management for the FDC, UART and parallel port.

The built-in audio in M1535D+ is an advanced PCI audio accelerator providing wave table synthesis, DirectMusic, DirectSound3D for the high performance, cost-sensitive consumer market. It also supports full Sound Blaster compatibility and is fully PC'98/PC'99 compliant. The M1535D+ Audio, combined with a standard AC'97/AC'98 Codec, provides better than CD quality audio with sound-to-noise ratio of > 90 db, up to 48 KHz sample rate, full duplex audio with independent playback and recording sample rate, 6-channel mixer and optional 3D surround sound enhanced output. In the legacy DOS game environment, the M1535D+ audio accelerator provides SoundBlaster Pro/16 compatibility, OPL2 and OPL3 emulation, and 1 to 8 MB of general MIDI music through the MPU 401 compatible interface. With built-in support of the legacy mode analog game port, the M1535D+ audio can replace all the functions of wave table based legacy audio ISA card. In addition, the M1535D+ supports consumer audio digital interface (SPDIF) to connect external digital audio equipment.

The M1535D+ will provide the AC'97 2.1 compliant digital controller interface for third parties (such as the AMC Codec's vendor) to enable the software modem solution. The M1535D+ provides 4 separate telephony bus master channel. One for modem output, one for modem input, one for handset input, and one for handset output. The M1535D+ supports the Modem on-demand variable sample rate transfer, power management , wake-up, and caller ID string transmission.

The M1535D+ will support the security feature such as the platform firmware protection. The M1535D+ also provides the ability to meet the

Legacy-Free and Legacy Reduction specification of PC2001.

1-7.1 PS/2 Keyboard and Mouse Interface

PS/2 keyboard and mouse connectors are located on the back panel of the motherboard. The +5 V lines to keyboard and mouse connectors are protected with a fuse that prevents motherboard components from being damaged when an over-current condition occurs.



Note

The mouse and keyboard can be plugged into either PS/2 connector. Power to the computer should be turned off before a keyboard or mouse is connected or disconnected.

The keyboard controller contains code, which provides the traditional keyboard and mouse control functions, and also supports Power On/Reset password protection. Power On/Reset password can be specified in the BIOS Setup program.

The keyboard controller also supports the hot-key sequence <Ctrl><Alt>, software reset. This key sequence resets the computer's software by jumping to the beginning of the BIOS code and running the Power On Self Test (POST).

1-8 HARDWARE MONITOR

The hardware monitor subsystem provides instrumentation capabilities.

The features of the hardware monitor subsystem include:

- 2 thermistor input for remote temperature sensing (CPU/System)
- Monitor 4 positive voltages (Vcore/+3.3V/+5V/+12V)
- Monitor 2 fan speeds
- 2 PWM outputs for fan speed control
- Power-on beep warning when CPU core voltage is out of range
- VID4-VID0 monitoring inputs
- Windows 95/98 utility included

1-9 WAKE ON LAN TECHNOLOGY

Wake on LAN technology enables remote wakeup of the computer through a network. Wake on LAN technology requires a PCI add-in network interface card (NIC) with remote wakeup capabilities. The remote wakeup connector on the NIC must be connected to the onboard Wake on LAN connector. The NIC monitors network traffic at the Ethernet interface; upon detecting a Magic Packet, the NIC asserts a wakeup signal that powers up the computer. This feature uses the Wake on LAN connector.

⚠ CAUTION

For Wake on LAN, the 5-V standby line for the power supply must be capable of delivering $+5V \pm 5\%$ at 720 mA. Failure to provide adequate standby current when implementing Wake on LAN can damage the power supply.

Chapter 2

HARDWARE INSTALLATION

Congratulations on your purchase of **SY-K7ADA** Motherboard. You are about to install and connect your new Motherboard.



Note: Do not unpack the Motherboard from its protective anti-static packaging until you have made the following preparations.

2-1 PREPARATIONS

Gather and prepare all the following hardware equipment to complete the installation successfully:

1. Socket 462 processor with built-in CPU cooling fan (boxed type).



Note: This Motherboard supports non-boxed type CPUs. The heavier CPU cooling fan requires the installation of a CPU support stand.

2. DDR RAM memory module (s)
3. Computer case and chassis with adequate power supply unit
4. Monitor
5. PS/2 Keyboard
6. Pointing Device (PS/2 mouse)
7. Speaker(s) (optional)
8. Disk Drives: HDD, CD-ROM, Floppy drive ...
9. External Peripherals: Printer, Plotter, and Modem (optional)
10. Internal Peripherals: Modem and LAN cards (optional)

2-2 UNPACKING THE MOTHERBOARD

When unpacking the Motherboard, check for the following items:

◆ The SY-K7ADA ALi MAGiK1 AGP/PCI Motherboard



◆ The Quick Start Guide



◆ The Installation CD-ROM



◆ SOYO Bonus Pack CD-ROM



◆ One IDE Device ATA33/66/100 Flat Cable



◆ One Floppy Disk Drive Flat Cable



◆ One Heat Sink Compound



Warning: Do not unpack the Motherboard from its anti-static packaging until you are ready to install it.

Like most electronic equipment, your Motherboard may be damaged by electrostatic discharge. To avoid permanent damage to components ground yourself while working by using a grounding strap. Otherwise, ground yourself frequently by touching the unpainted portion of the computer chassis to drain the static charges.

Handle the Motherboard carefully, hold it by the edges.

You are now ready to start the installation.

2-3 INSTALLATION GUIDE

We will now begin the installation of the Motherboard. Please follow the step-by-step procedure designed to lead you to a complete and correct installation.



Warning: Turn off the power to the Motherboard, system chassis, and peripheral devices before performing any work on the Motherboard or system.

BEGIN THE INSTALLATION

2-3.1 CPU Installation

Your SY-K7ADA motherboard comes with a CPU retention set kit. The retention set is used to hold the processor attached to the Socket 462 CPU connector on the motherboard.

Mark your CPU Frequency: Record the working frequency of your CPU that should be clearly marked on the CPU cover.

200MHz FSB Athlon CPU

<input type="checkbox"/> 750 MHz (100 x 7.5)	<input type="checkbox"/> 800 MHz (100 x 8.0)	<input type="checkbox"/> 850 MHz (100 x 8.5)	<input type="checkbox"/> 900 MHz (100 x 9.0)	<input type="checkbox"/> 950 MHz (100 x 9.5)
<input type="checkbox"/> 1000 MHz (100 x 10.0)	<input type="checkbox"/> 1.1GHz (100 x 11.0)	<input type="checkbox"/> 1.2GHz(100 x 12.0)	<input type="checkbox"/> 1.3GHz (100 x 13.0)	

200MHz FSB Duron CPU

<input type="checkbox"/> 600 MHz (100 x 6.0)	<input type="checkbox"/> 650 MHz (100 x 6.5)	<input type="checkbox"/> 700 MHz (100 x 7.0)	<input type="checkbox"/> 750 MHz (100 x 7.5)	<input type="checkbox"/> 800 MHz (100 x 8.0)
<input type="checkbox"/> 850 MHz (100 x 8.5)	<input type="checkbox"/> 900 MHz (100 x 9.0)	<input type="checkbox"/>	<input type="checkbox"/>	<input type="checkbox"/>

266MHz FSB Athlon CPU

<input type="checkbox"/> 1 GHz (133 x 7.5)	<input type="checkbox"/> 1.13 GHz (133 x 8.5)	<input type="checkbox"/> 1.2 GHz (133 x 9.0)	<input type="checkbox"/> 1.33 GHz (133 x 10.0)
--	---	--	--

Follow these instructions to install your Socket 462 processor correctly.

1. Lift the socket handle up to a vertical position.

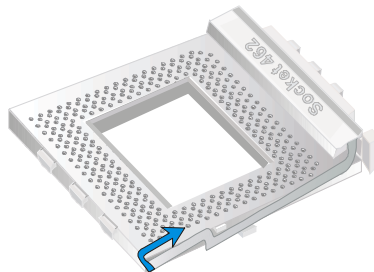

2. Align the blunt edge of the CPU with the matching pinhole distinctive edge on the socket.

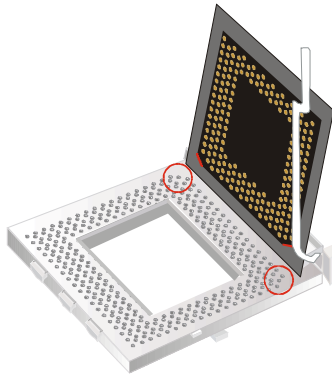

3. Seat the processor in the socket completely and without forcing.

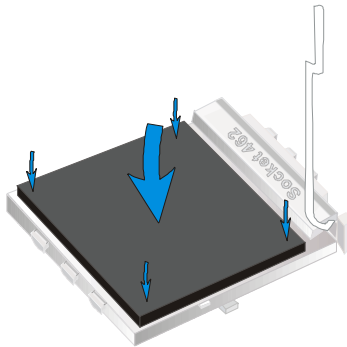

4. Then close the socket handle to secure the CPU in place.

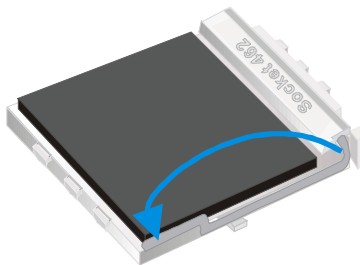



Remember to connect the CPU Cooling Fan to the appropriate power connector on the Motherboard. *The fan is a key component that will ensure system stability. The fan prevents overheating, therefore prolonging the life of your CPU.*

2-3.2 DDR SDRAM Memory Module Installation

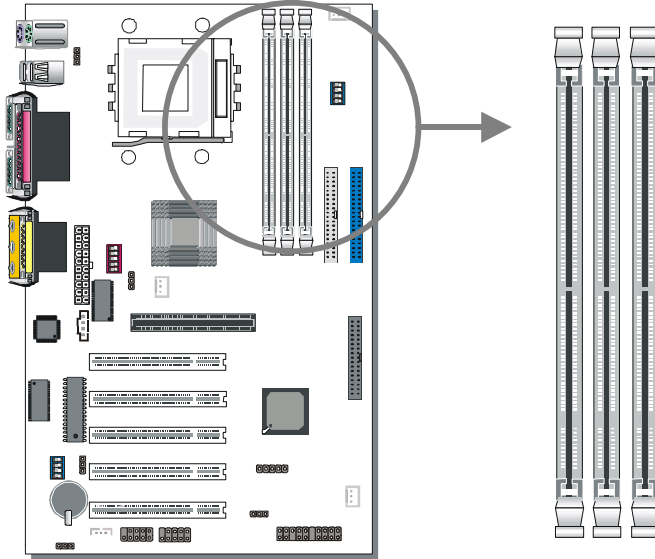

Your board comes with three DIMM sockets, providing support for up to 3GB of main memory using DDR RAM modules from 4Mb to 512Mb. On this motherboard, DRAM speed can be set independent from the CPU front side bus speed. Appropriate memory modules must be used. Supports DDR frequency 100/133 MHz.

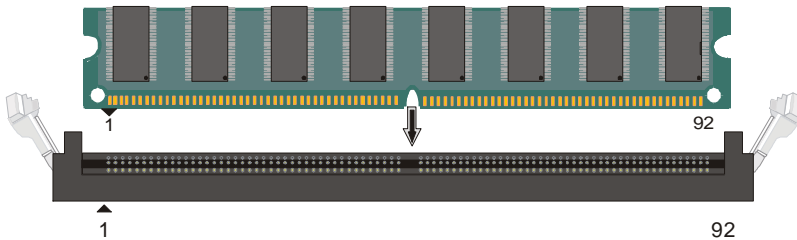

Memory Configuration Table

Number of Memory Modules	DIMM 1	DIMM 2	DIMM 3
RAM Type	DDR SDRAM		
Memory Module Size	4/16/32/64/128/256/512 Mbit		

Note: This Motherboard can only support 2 pcs of PC2100 DDR module, we suggest using DIMM1 and DIMM2 for PC2100 DDR module.

2-3.3 Motherboard Connector

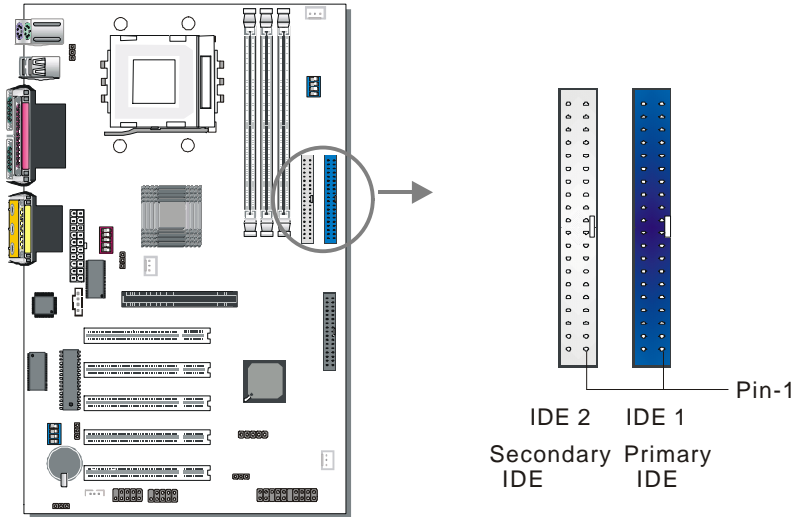

2-3.3.1 IDE Device Installation (HDD, CD-ROM)

This Motherboard offers two primary and secondary IDE device connectors (IDE1, IDE2). It can support up to four high-speed Ultra DMA 33/66/100HDD or CD-ROM.

Connect one side of the ATA33/66/100 flat cable to the IDE device (HDD or CD-ROM) and plug the other end to the primary (IDE1) or secondary (IDE2) directionally keyed IDE connector on the Motherboard. The ATA33/66/100 cable is backward compatible with ATA33 HDDs.

This Motherboard can support up to four HDDs.

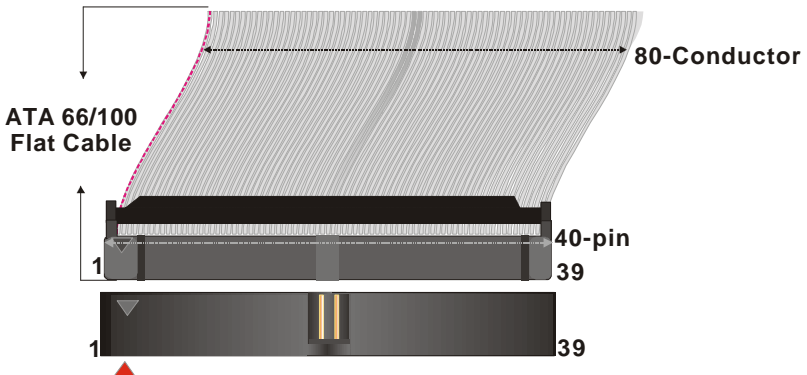

2-3.3.2 Floppy Drive Installation

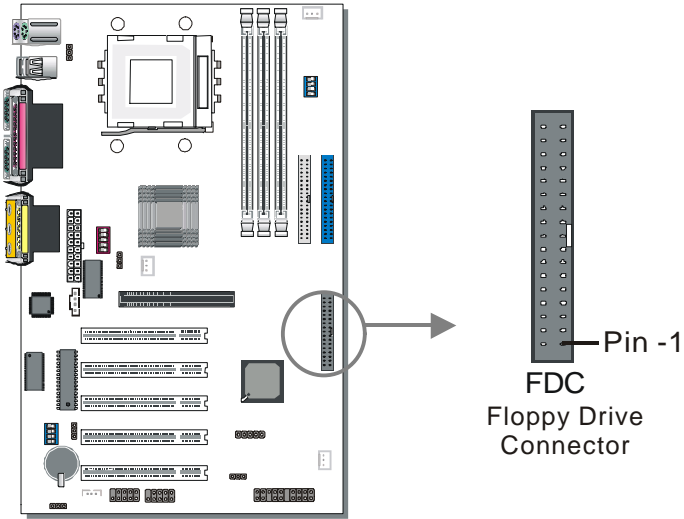

The system supports 5 possible floppy drive types: 720 KB, 1.2 MB, 1.44 MB, 2.88 MB, and LS-120.

Connect one side of the 34-pin flat cable to the floppy drive and plug the other end to the floppy drive connector on the Motherboard.

This Motherboard can support up to 2 floppy drives.

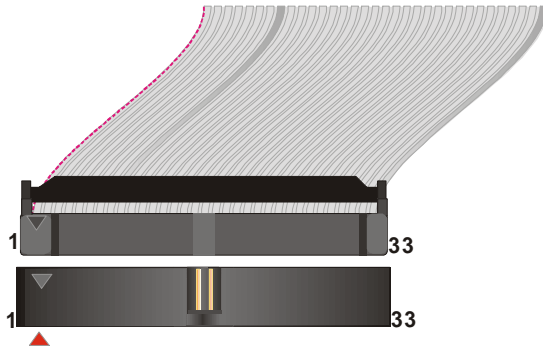

2-3.3.3 Front Panel Connections

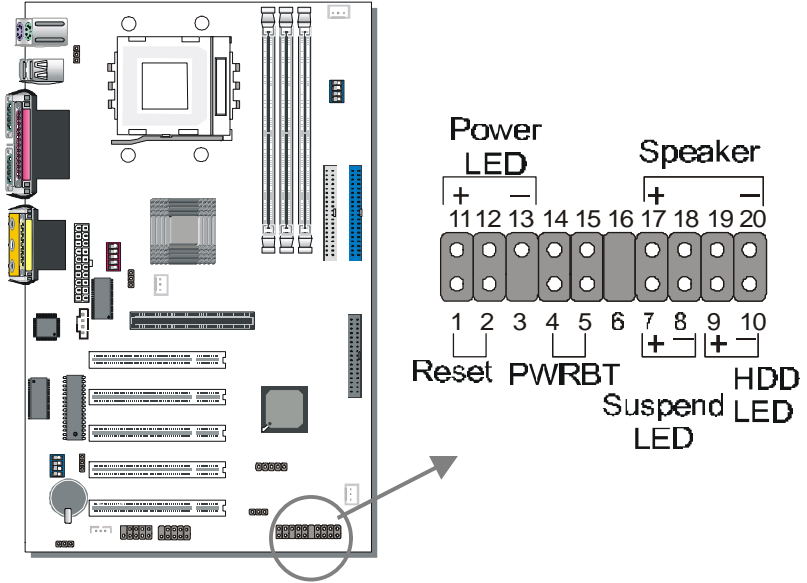

Plug the computer case's front panel devices to the corresponding headers on the Motherboard.

1. Power LED

Please install according to the following pin assignment: pin 1,3 are for Power LED.

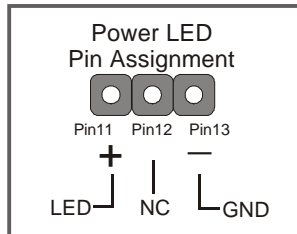

2. Reset

Plug the Reset push-button cable into the 2-pin Reset header on the Motherboard. Pushing the Reset button on the front panel will cause the system to restart the boot-up sequence.

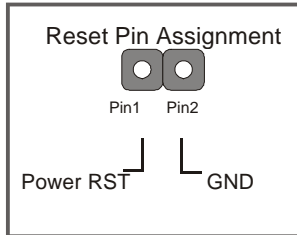

3. Speaker

Attach the 4-pin PC speaker cable from the case to the Speaker header on the Motherboard.

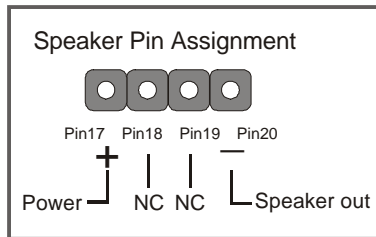

4. IDE LED

Attach the 2-pin IDE device LED cable to the corresponding IDE LED header on the Motherboard. This will cause the LED to light up when an IDE (HDD, CD-ROM) device is active.

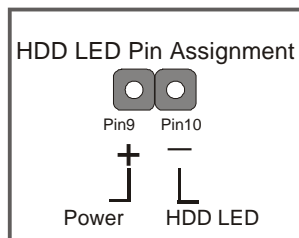

5. ATX Power On/Off Switch

Attach the 2-pin momentary type switch to the PWRBT header for turning On or Off your ATX power supply.

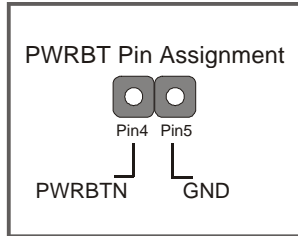

2-3.3.4 Back Panel Connections

All external devices such as the PS/2 keyboard, PS/2 mouse, printer, modem, USB1, USB2 can be plugged directly onto the Motherboard back panel.

Only after you have fixed and locked the Motherboard to the computer case can you start connecting the external peripheral devices.

When connecting an external device, use the following figure to locate and identify which back panel connector to plug the device to.

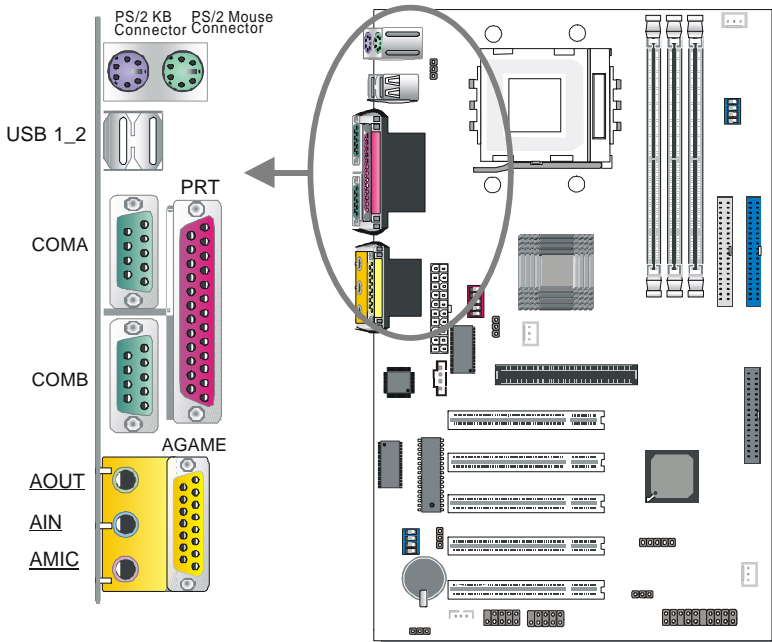

1. Onboard Serial Ports COM1/COM2

External peripherals that use serial transmission scheme include:

- serial mouse,
- and modem.

Plug the serial device cables directly into the COM1/COM2 9-pin male connectors located at the rear panel of the Motherboard.

2. Parallel Port PRT

This parallel port is used to connect the printer or other parallel devices.

Plug the parallel device cable into the 25-pin female connector located at the rear panel of the Motherboard.

3. PS/2 Keyboard

Plug the keyboard jack directly into the 6-pin female PS/2 keyboard connector located at the rear panel of the Motherboard.

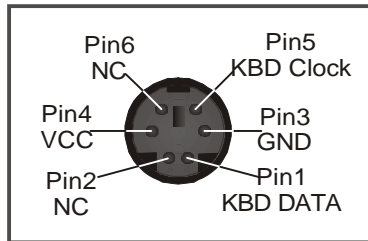

4. PS/2 Mouse

Similarly, plug the mouse jack directly into the 6-pin female PS/2 mouse connector.

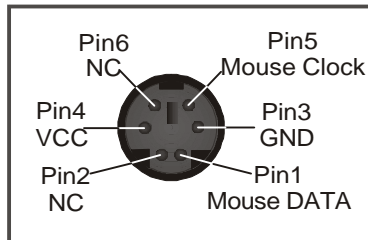

5. Universal Serial Bus (USB3, USB4/USB5, USB6)

This Motherboard provides four USB ports for your additional devices. Plug the USB device jack into the available USB connector USB3, USB4, USB5 and USB6 via USB cable.

- Standard device drivers come with the Win98 for commonly used USB devices.
- With Win95, use the flow OpenHCI 1.0a specifications. To use USB devices under Win95, usually you have to install the device that driver comes with the USB device you have purchased.

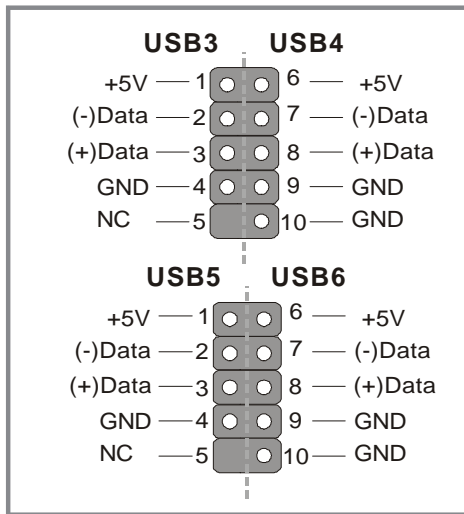

6. Onboard Joystick port/audio

This Motherboard provides Joystick port and audio.

- Attach the joystick cable to the 15-pin JOYSTICK port at the rear panel of your motherboard.
- This Motherboard features three built-in audio-stereo ports (labeled line-in, line-out, and mic jack) convenient to directly plug-in all your external audio devices.

2-3.3.5 Other Connections

1. Wake-On-LAN (WOL)

Attach the 3-pin connector from the LAN card which supports the Wake-On-LAN (WOL) function to the JP10 header on the Motherboard. This WOL function lets users wake up the connected computer through the LAN card.

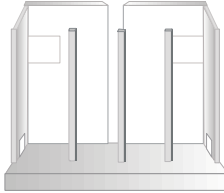

Please install according to the following pin assignment:

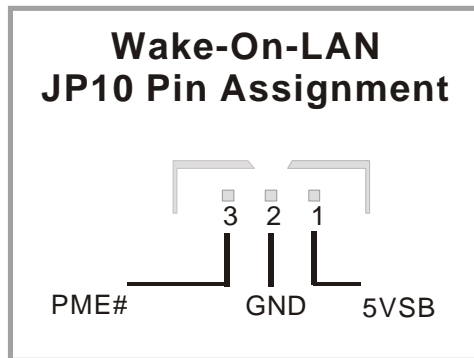

2. Infrared

Plug infrared device cable to the SIRCON header. This will enable the infrared transfer function. This Motherboard meets both the IrDA 1.0 (SIR) and IrDA 1.1 (FIR and MIR) specifications. Supports sharp-IR.

Please install according to the following pin assignment:

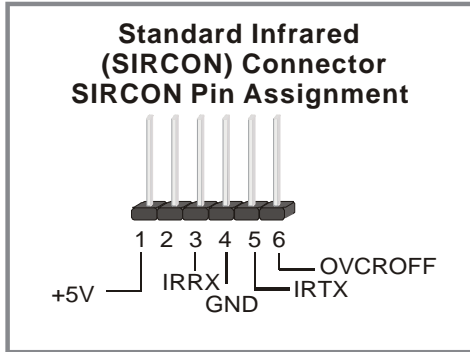

3. Other Display Cards

Insert other types of VGA cards into the PCI or ISA expansion slots according to card specifications.

4. Cooling Fan Installation

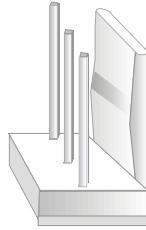

(1) CPU Cooling Fan

After you have seated the CPU properly on the processor, attach the 3-pin fan cable to the CPUFAN connector on the Motherboard. The fan will stop when the system enters into Suspend Mode. (Suspend mode can be enabled from the BIOS Setup Utility, [POWER MANAGEMENT] menu.) To avoid damage to the system, install according to the following pin assignment:

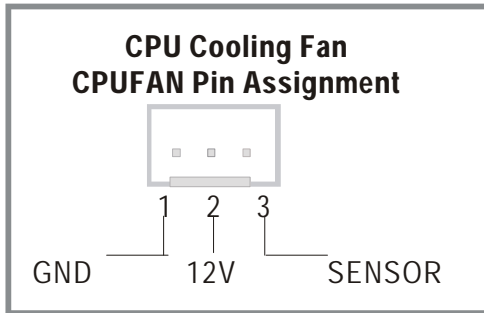

(2) Chassis Cooling Fan

Some chassis also feature a cooling fan. This Motherboard features a CHAFAN connector to provide 12V power to the chassis fan. Connect the cable from the chassis fan to the CHAFAN 3-pin connector. Install according to the following pin assignment:

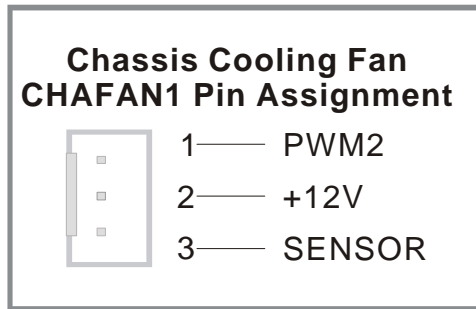

(3) Chipset Cooling Fan

Some chipset also feature a cooling fan. This Motherboard features a ChipFAN connector to provide 12V power to the chassis fan. Connect the cable from the chassis fan to the ChipFAN 3-pin connector. Install according to the following pin assignment:

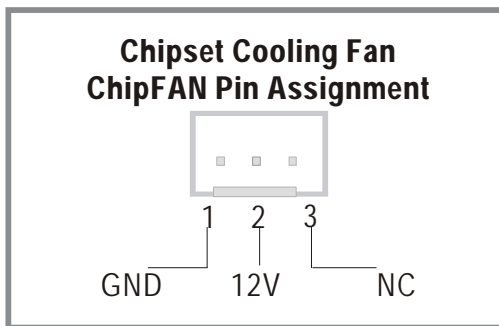

Note: CPUFAN/ChipFAN must be installed for this Motherboard, CHAFAN is optional.

5. CD Line-in (CDIN1)

This Motherboard provides two CD-Line in connectors. Please connect the 4-pin audio cable from your CD-ROM drive to either CDIN1. (It fits in only one, depending on the cable that came with your CD-ROM drive)

Please install according to the following pin assignment:

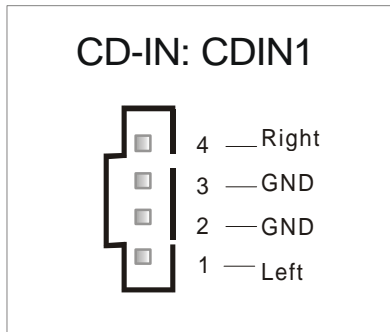

2-3.3.6 AGP VGA Card

Insert the AGP VGA card into the AGP slot. Then connect the monitor information cable to the AGP card back plane external connector.

Follow the manufacturer's instructions to perform the AGP VGA drivers installation.

2-3.3.7 ATX Power Supply

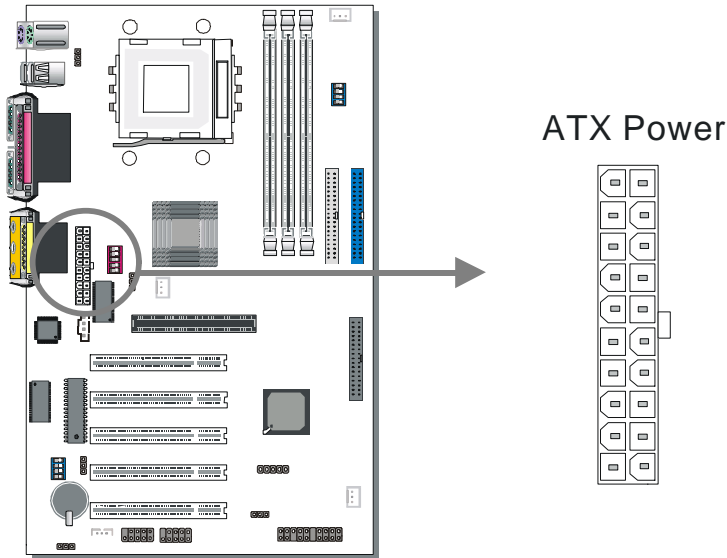

Plug the connector from the power directly into the 20-pin male ATX PW connector on the Motherboard, as shown in the following figure.



Warning: Follow these precautions to preserve your Motherboard from any remnant currents when connecting to ATX power supply:

Turn off the power supply and unplug the power cord of the ATX power supply before connecting to ATX PW connector.

The Motherboard requires a power supply with at least 200 Watts and a "power good" signal. Make sure the ATX power supply can take at least 720 mA * load on the 5V Standby lead (5VSB) to meet the standard ATX specification.

* **Note:** If you use the Wake-On-LAN (WOL) function, make sure the ATX power supply can support at least 720 mA on the 5V Standby lead (5VSB).

Please install the ATX power according to the following pin assignment:

ATX Power

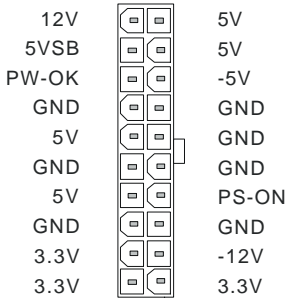





➤ **Pay special care to the directionality.**

2-3.4 Jumper Setting

2-3.4.1 Multiplier Adjustment Setting (RJ1)

For certain AMD™ CPUs, the multiplier is not locked such that setting a multiplier higher than specified on the CPU is possible. For technical details read the following:

Refer to the following table to set the Frequency Multiplier of your CPU.

Frequency Multiplier Setting	RJ2	RJ3
Auto	Short Pin1-2 	Short Pin1-2 
Manual	Short Pin2-3 	Short Pin2-3 



If you set ratio to manual and configure the RJ1 DIP Switch to the settings that match your CPU speed, as follow table:

RJ1	1	2	3	4	RJ1	1	2	3	4
5	On	On	Off	On	9	On	On	Off	Off
5.5	Off	On	Off	On	9.5	Off	On	Off	Off
6	On	Off	Off	On	10	On	Off	Off	Off
6.5	Off	Off	Off	On	10.5	Off	Off	Off	Off
7	On	On	On	Off	11	On	On	On	On
7.5	Off	On	On	Off	11.5	Off	On	On	On
8	On	Off	On	Off	12	On	Off	On	On
8.5	Off	Off	On	Off	12.5	Off	Off	On	On

Note: SOYO does not guarantee system stability if the user over clocks the system. Any malfunctions due to over-clocking are not covered by the warranty.

2-3.4.2 Enable/Disable Power-On by Keyboard (JP1)

You may choose to enable the Power-On through Keyboard function by shorting pin 2-3 on jumper JP1; or short pin 1-2 to disable this function.

Power-On by Keyboard	Enable	Disable
JP1 Setting	Short pin 2-3 to enable the Power-On by Keyboard function. 	Short pin 1-2 and the Power-On by Keyboard function is disabled. 

Important: When using the Power-On by Keyboard function, please make sure the ATX power supply is able to provide at least 720mA on the 5V Standby lead (5VSB) in order to meet the standard ATX specification.

2-3.4 The synchronous/asynchronous clock mode between CPU and memory interface setting



The FSB Frequency can be set through DIP switch FJ1 or BIOS and it may therefore differ from the Frequency the CPU specifies. Doing so may however force your CPU to operate out of its specifications and therefore SOYO can not guarantee the proper functioning of your system.

Refer to the following table:

CPU Freq(MHz)	SDRAM(MHz)	1	2	3	4
100	100	On	On	Off	Off
133	133	On	Off	Off	Off

2-3.5 CPU Vcore adjustment (VJ1)

Refer to following table to set the voltage of your CPU. **If you set VJ2 status to AUTO, please set VJ1 switch status to Off (all).**

Status Setting	VJ2
Manual	Short Pin2-3 
Auto	Short Pin1-2 

If you set status to manual and configure VJ1 switch to the settings that match your CPU voltage as follow table:

VJ1	1	2	3	4	5	VJ1	1	2	3	4	5
Auto	OFF	OFF	OFF	OFF	OFF	1.475	OFF	OFF	OFF	OFF	ON
1.100	ON	OFF	OFF	OFF	OFF	1.500	ON	OFF	OFF	OFF	ON
1.125	OFF	ON	OFF	OFF	OFF	1.525	OFF	ON	OFF	OFF	ON
1.150	ON	ON	OFF	OFF	OFF	1.550	ON	ON	OFF	OFF	ON
1.175	OFF	OFF	ON	OFF	OFF	1.575	OFF	OFF	ON	OFF	ON
1.200	ON	OFF	ON	OFF	OFF	1.600	ON	OFF	ON	OFF	ON
1.225	OFF	ON	ON	OFF	OFF	1.625	OFF	ON	ON	OFF	ON
1.250	ON	ON	ON	OFF	OFF	1.650	ON	ON	ON	OFF	ON
1.275	OFF	OFF	OFF	ON	OFF	1.675	OFF	OFF	OFF	ON	ON
1.300	ON	OFF	OFF	ON	OFF	1.700	ON	OFF	OFF	ON	ON
1.325	OFF	ON	OFF	ON	OFF	1.725	OFF	ON	OFF	ON	ON
1.350	ON	ON	OFF	ON	OFF	1.750	ON	ON	OFF	ON	ON
1.375	OFF	OFF	ON	ON	OFF	1.775	OFF	OFF	ON	ON	ON
1.400	ON	OFF	ON	ON	OFF	1.800	ON	OFF	ON	ON	ON
1.425	OFF	ON	ON	ON	OFF	1.825	OFF	ON	ON	ON	ON
1.450	ON	ON	ON	ON	OFF	1.850	ON	ON	ON	ON	ON

2-3.7 CMOS Clearing (JP5)

After you have turned off your computer, clear the CMOS memory by momentarily shorting pins 2-3 on jumper JP5, for a few seconds. Then restore JP5 to the initial 1-2 jumper setting in order to recover and retain the default settings.

Jumper JP5 can be easily identified by its white colored cap.

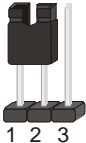
CMOS Clearing	Clear CMOS Data	Retain CMOS Data
JP5 Setting	Short pin 2-3 for <i>at least 5 seconds</i> to clear the CMOS 	Short pin 1-2 to retain new settings 
<p>Note: You must unplug the ATX power cable from the ATX power connector when performing the CMOS Clear operation.</p>		

2-3.8 Power On

You have now completed the hardware installation of your Motherboard successfully.

1. Turn the power on
2. To enter the BIOS Setup Utility, press the key while the system is performing the diagnostic checks,



Note: If you have failed to enter the BIOS, wait until the boot up sequence is completed. Then push the RESET button and press key again at the beginning of boot-up, during diagnostic checks.

Repeat this operation until you get the following screen.

3. The BIOS Setup screen appears:

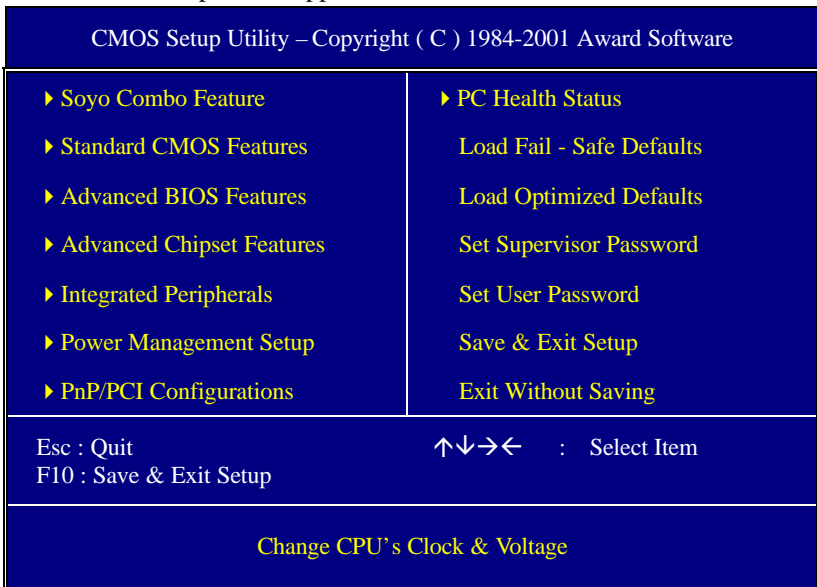

2-3.9 Quick BIOS Setup

This Motherboard does not use any hardware jumpers to set the CPU frequency. Instead, CPU settings are software configurable with the BIOS [SOYO COMBO SETUP]. The [SOYO COMBO SETUP] menu combines the main parameters that you need to configure, all in one menu, for a quick setup in BIOS.

After the hardware installation is complete, turn the power switch on, then press the key during the system diagnostic checks to enter the Award BIOS Setup program. The CMOS SETUP UTILITY will display on screen. Follow these steps to configure the CPU settings.

Step 1. Select [STANDARD CMOS SETUP]

Set [Date/Time] and [Floppy drive type], then set [Hard Disk Type] to “Auto”.

Step 2. Select [LOAD SETUP DEFAULT]

Select the “LOAD SETUP DEFAULT” menu and type “Y” at the prompt to load the BIOS optimal setup.

Step 3. Select [SAVE & EXIT SETUP]

Press <Enter> to save the new configuration to the CMOS memory, and continue the boot sequence.

2-3.10 Troubleshooting at First Start

Video (no display) related issues

I built a new computer system using a Soyo board and nothing happens when turning it on, no video and no beeps from the PC speaker. What is happening and how can it be fixed?

No screen and no beeps mean that your CPU and motherboard do not work at all. It could be that the CPU is not seated correctly or that a component on the M/B is grounded (shorted) with the case. Also make sure to check the voltage setting switch (110V/220V) on the back of the power supply. To isolate the problem do the following:

1. Press and hold down on the “Ins” (insert) key while turning on the computer until you get video. If you do not get video then,
2. Double-check jumpers setting on you motherboard and remove all add-on cards, unplug all hard-disk and floppy-disk drive cables and see if you can hear some beeps. If you still do not get any beeps, then try putting the motherboard on the table (to isolate it from the case) with the CPU and speaker only, and give it one more try.

I hear a series of beeps and I do not get anything from my monitor. What could be wrong?

The following lists some basic beep codes and their possible meanings:

- One long beep and 3 very short beeps - The video card is not detected by the motherboard. Please re-seat your video card. If you are using an AGP card, please push your AGP card down real hard. You may have to push VERY hard without the AGP card mounting screw. Make sure not to insert the card the other way around.
- Continuous beeps – One or more of the memory modules is not seated correctly in its socket.

My PCI VGA card works fine with my system, but when I put in a new AGP card, it does not give me any video. Is my AGP slot bad?

This is a common problem with AGP video cards. The reason is that your AGP card did not get seated into the AGP slot fully and firmly. Please push your AGP card down into the socket real hard, it should snap twice. You may have to unscrew the AGP card to allow the card to go further down. Do take care not to damage the card by using too much force.

I get distorted video my AGP card right after I save my bios. Why is that?

The cause is likely that your AGP card is not running at the correct bus speed. To fix this, please clear the CMOS ALi JP5 and if it still does not work, please upgrade your motherboard bios to the latest version.

BIOS Issues

Where can I find the BIOS revision of my mainboard?

It will be displayed on the up-left corner on the screen during boot-up. It will show as your board type followed by the revision number, such as 5EH_2CA1 (meaning revision 2CA1 for the SY-5EH board) or 6BA+ IV_2AA2 which means SY-6BA+ IV motherboard with 2AA2 bios.

Where can I find the latest BIOS of my motherboard?

Please go to the technical support page of one of the SOYO websites (Taiwan: www.soyo.com.tw), and look up your motherboard to find the latest BIOS revision.

Hard disk, floppy drive, CD-ROM etc

When I boot up my new computer I got "floppy boot failure" and the LED on the floppy stays on

Make sure the red wire of floppy ribbon cable goes to Pin1 on the floppy drive side (don't trust the "key lock" or "notch") and use the end-connector of the cable (don't use middle one).

Modem issues

I get an "I/O Conflict" message when I turn on my system and I can not get my modem to work

What you need to do is to disable 'COM2' (or UART2 or serial port 2) in the bios under integrated peripheral setup.

I have installed my modem drivers several times and I still cannot get my modem to work. Why?

If you are sure that the modem driver has been installed correctly, then you need to install the south bridge driver from the SOYO CD, this is because Windows does not properly recognize relatively new chipsets.

Audio Issues

I do not get any sound from my sound card. What could be wrong?

Please make sure the speaker is connected to the speaker out port on your sound card.

In Device Manager, I keep getting yellow exclamation signs on my sound port even though I have installed my sound driver several times and I could not get my sound card to work. What is wrong?

It is likely that you did not have the correct driver installed. If you are sure that the correct sound driver has been installed, then please install the 'south bridge' driver for the motherboard.

The sound is working in my system, but when I play CD music from the CD-ROM, I do not get any sound. What is wrong?

This is because the 3-wire audio cable from the CD-ROM to the sound card is not connected or it is loose.

The sound from my sound card is distorted when Windows starts. What is wrong?

First, if you are using an ISA sound card, please make sure the IRQ needed for the sound card is set to 'Legacy ISA' in the bios. In other words, if your ISA sound card takes IRQ5, then set IRQ5 to 'Legacy ISA'. Next, install the 'south bridge' driver for the motherboard.

The sound and everything else works fine except that the recorder and microphone do not work. What is wrong?

This is because the recorder and microphone in the Windows are not enabled. Please go to sound properties and enable them.

Lock up (freeze)

When I boot up my system, everything works fine. It sees my CPU and memory, detects my hard drive, floppy drive and CD-ROM but locks up at "Verify DMI pool data... ", and it won't go any further.

What should I do?

Please clear the CMOS ALi JP5 then choose 'load fail-safe default' in the bios and save the bios and exit. Next, unplug all other add-on cards except the video card and floppy drive controller, and see if it can boot from floppy. Then put back the peripherals one by one to identify which one causes the lockup.

I can not get my board to run properly.

Please make sure you have the latest bios and driver from the SOYO web site at: <http://www.soyo.com>

2-3.11 Power Off

There are two possible ways to turn off the system:

1. Use the **Shutdown** command in the **Start Menu** of Windows 95/98 to turn off your computer.
2. Press the mechanical power-button and **hold down for over 4 seconds**, to shutdown the computer. If you press the power-button for less than 4 seconds, then your system will enter into **Suspend Mode**.

You are now ready to configure your system with the BIOS setup program. Go to *Chapter 3: BIOS SETUP*

Chapter 3

BIOS SETUP UTILITY

This Motherboard's BIOS setup program uses the ROM PCI/ISA BIOS program from Award Software Inc.

To enter the Award BIOS program's Main Menu:

1. Turn on or reboot the system.
2. After the diagnostic checks, press the [Del] key to enter the Award BIOS Setup Utility.

CMOS Setup Utility – Copyright (C) 1984-2001 Award Software	
<ul style="list-style-type: none"> ▶ SOYO COMBO Feature ▶ Standard CMOS Features ▶ Advanced BIOS Features ▶ Advanced Chipset Features ▶ Integrated Peripherals ▶ Power Management Setup ▶ PnP/PCI Configurations 	<ul style="list-style-type: none"> ▶ PC Health Status Load Fail - Safe Defaults Load Optimized Defaults Set Supervisor Password Set User Password Save & Exit Setup Exit Without Saving
Esc : Quit F10 : Save & Exit Setup	↑↓→← : Select Item
Change CPU's Clock & Voltage	

Selecting items

- Use the arrow keys to move between items and select fields.
- From the Main Menu press arrow keys to enter the selected submenu.

Modifying selected items

- Use the [Up]/[Down] keys to modify values within the selected fields. Some fields let you enter values directly.

Hot Keys: Function keys give you access to a group of commands throughout the BIOS utility.

Function	Command	Description
F1	General Help	Gives the list of options available for each item.
F5	Previous Values	Restore the old values. These are the values that the user started the current session with.
F6	Load Fail-Safe Defaults	Loads all items with the most conservative values.
F7	Load Optimized Defaults	Loads all options with the optimize values.
F10	Save	Saves your changes and reboots the system.
[Esc]	Exit	Returns at anytime and from any location to the Main Menu.
[Enter]	Select	Will display a overlapping window with all options for the current item.
[+/-/PU/PD]	Value	Using the +, -, Page Up and Page Down keys the user can toggle the value of the current item.

SAVE AND EXIT SETUP

Select the [SAVE & EXIT SETUP] option from the Main Menu to save data to CMOS and exit the setup utility. This option saves all your changes and causes the system to reboot.

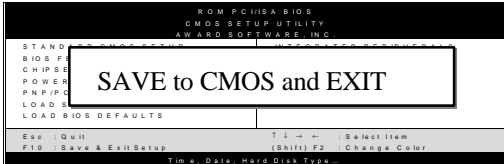

Type [Y] to save the changes and exit or [N] to return to the Main Menu and keep current values.

EXIT WITHOUT SAVING

Selecting the [EXIT WITHOUT SAVING] option allows you to abandon all data and exit setup, therefore ignoring all your changes.

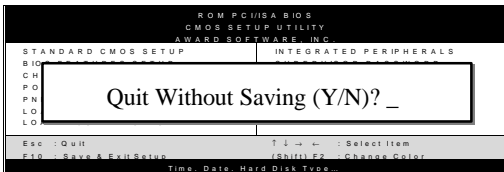

Type [Y] to abandon changes and exit or [N] to return to the Main Menu and keep current values.

3-1 SOYO COMBO SETUP

This Motherboard does not use any hardware jumpers to set the CPU frequency. Instead, CPU settings are software configurable with the BIOS [SOYO COMBO SETUP].

After the hardware installation is complete, turn the power switch on, then press the key during the system diagnostic checks to enter the Award BIOS Setup program. The CMOS SETUP UTILITY will display on screen. Then, select the [SOYO COMBO SETUP] option from the main menu and press the <Enter> key.

CMOS Setup Utility – Copyright (C) 1984-2001 Award Software SOYO COMBO Feature		Item Help
Auto Detect DIMM/PCI Clk	Enabled	Menu Level ▶
Spread Spectrum	Disabled	
CPU Host/SDRAM/PCI Clock	Default	
System Performance	Normal	
Quick Power On Self Test	Enabled	
First Boot Device	Floppy	
Second Boot Device	HDD-0	
Third Boot Device	LS120	
Boot Other Device	Enabled	
ALI OnChip Audio	Enabled	
POWER ON Function	BUTTEN ONLY	
xKB Power On Password	Enter	
xHot Key Power ON	Ctrl-F1	

↑↓→←:Move Enter:Select +/-/PU/PD:Value F10:Save ESC:Exit F1:General Help
 F5:Previous Values F6:Fail-Safe Defaults F7: Optimized Defaults

The [SOYO COMBO SETUP] menu combines the main parameters that you need to configure, all in one menu, for a quick setup in BIOS.

3-1.1 Quick CPU Frequency Setup

	Setting	Description	Note
Auto Detect DIMM/PCI Clk	Disabled	For EMI test purpose.	
	Enabled		Default
Spread Spectrum Modulated	Disabled		Default
	Enabled	When using Spread Spectrum Modulated 1.5% or 6% for FCC or DOC testing.	
CPU Host/SDRAM/PCI Clock	Default	102/136/34 MHz	This item lists the CPU host clock and the PCI bus clock. It is a read only item.
	100/100/33 MHz	105/140/35 MHz	
	101/101/33 MHz	107/142/35 MHz	
	102/102/34 MHz	133/133/33 MHz	
	103/103/34 MHz	136/136/34 MHz	
	105/105/35 MHz	137/137/34 MHz	
	107/107/35 MHz	140/140/35 MHz	
	110/110/36 MHz	143/143/35 MHz	
System Performance	Normal	Adjust your computer performance.	Default
	Maximum	Setting "maximum performance" may cause your system unstable by hardware compatibility issue.	

3-1.2 Quick Power On Self Test

	Setting	Description	Note
Quick Power On Self Test	Disabled		
	Enabled	Provides a fast POST at boot-up.	Default

3-1.3 System Boot Control Settings

System Boot Control Settings	Setting	Description	Note
First /Second/Third Boot Device	Floppy	Select Your Boot Device Priority	
	LS/ZIP		
	HDD-0		
	SCSI		
	CDROM		
	HDD-1		
	HDD-2		
	HDD-3		
	LAN		
	Disabled		
Boot Other Device	Disabled	Select Your Boot Device Priority	Default
	Enabled		
ALi OnChip Audio	Enabled	This item allows you to control the onboard AC 97 audio.	Default
	Disabled		

3-1.4 Power Management

	Setting	Description	Note
Power On Function & KB Power On & Hot Key Power On	Password	Enables you to wake-up the system by entering a password at the keyboard.	
	Hot key	You can wake-up the system by pressing the key combination of your choice (Ctrl-F1~F12).	
	Mouse Left		
	Mouse Right		
	Button only	Disables the Wake-Up by Keyboard function.	Default
	Keyboard 98		

STANDARD CMOS SETUP

Select the [STANDARD CMOS SETUP] option from the Main Menu and press [Enter] key.

CMOS Setup Utility – Copyright (C) 1984-2001 Award Software
 Standard CMOS Features

Date (mm:dd:yy)	Tue, Jan 4 2001	Item Help
Time (hh:mm:ss)	1 : 22 : 12	
▶ IDE Primary Master	None	Menu Level ▶
▶ IDE Primary Slave	None	
▶ IDE Secondary Master	None	
▶ IDE Secondary Slave	None	
Drive A	1.44M, 3.5 in.	
Drive B	None	
Floppy 3 Mode Support	Disabled	
Video	EGA/VGA	
Halt On	All Errors	
Base Memory	640K	
Extended Memory	64512K	
Total Memory	65536K	

↑↓→←:Move Enter:Select +/-/PU/PD:Value F10:Save ESC:Exit F1:General Help
 F5:Previous Values F6:Fail-Safe Defaults F7: Optimized Defaults

This screen allows you to modify the basic CMOS settings.

After you have completed the changes, press [Esc] key to return to the Main Menu.

3-1.5 Date & Time

	Display	Setting	Please Note
Date	mm/dd/yyyy	Type the current date	You can also the PUp/PDn keys to toggle
Time	hh:mm:ss	Type the current time	24-hour clock format 3:15 PM is displayed as 15:15:00

3-1.6 Hard Disks Type & Mode

Choose the type and mode for the hard disks that you have already installed.

Primary (Secondary) Master & Slave	Setting	Description	Note
IDE HDD Auto-Detection	Press Enter	To auto-detect the HDD's size, head ..on this channel	
	Auto	BIOS detects hard disk type automatically.	Default
IDE Primary Slave (User Type)	User	User defines the type of hard disk.	
	None		
Access Mode	Auto	BIOS detects hard disk mode automatically.	Default
	Normal	Normal IDE hard disk	<528MB
	LBA	Enhanced IDE hard disk	>528MB
	Large	Large IDE hard disk (for certain hard disk)	



Note: If you have any questions on your hard disk type or mode, ask your hard disk provider or previous user for details.

3-1.7 Floppy Drives

Floppy Drives	Setting	Description	Note
Drives A & B	360KB, 5.25 in.		
	1.2MB, 5.25 in.		
	720KB, 3.5 in.		
	1.44MB, 3.5 in.		Default
	2.88MB, 3.5 in.		
	None	Not installed	
Floppy 3-Mode Support	Disabled		Default
	Drive A Drive B Both	Supports 3-mode floppy diskette: 740KB/1.2MB/1.44MB on selected disk drive.	Special disk drive commonly used in Japan

3-1.8 Others Optional

	Setting	Description	Note
Video	EGA/VGA	Select the video mode.	Default
	CGA 40		
	CGA 80		
	MONO (Monochrome)		
Halt On	ALL Errors	When the BIOS detects system errors, this function will stop the system. Select which type of error will cause the system halt.	Default
	No Errors		
	All, But Keyboard		
	All, But Diskette		
	All, But Disk/Key		

3-2 ADVANCED BIOS FEATURES

Select the [Advanced BIOS Features] option from the Main Menu and press [Enter] key.

CMOS Setup Utility – Copyright (C) 1984-2001 Award Software
Advanced BIOS Features

Virus Warning Disabled CPU Internal Cache Enabled External Cache Enabled Swap Floppy Drive Disabled Boot Up Floppy Seek Enabled Boot Up NumLock Status On Boot Up System Speed High Gate A20 Option Fast Typematic Rate Setting Disabled x Typematic Rate (Chars/Sec) 6 x Typematic Delay (Msec) 250 Security Option Setup OS Select For DRAM > 64MB Non-OS2 Report No FDD For WIN 95 No Video BIOS Shadow Enabled		Item Help <hr/> Menu Level ▶
--	--	---------------------------------

↑↓→←:Move Enter:Select +/-/PU/PD:Value F10:Save ESC:Exit F1:General Help
 F5:Previous Values F6:Fail-Safe Defaults F7: Optimized Defaults

After you have completed the changes, press [Esc] key and follow the instructions on your screen to save your settings or exit without saving.

3-2.1 Virus Warning

	Setting	Description	Note
Virus Warning	Disabled	Allows you to choose the VIRUS Warning feature for IDE Hard Disk boot sector protection. If this function is enabled and someone attempt to write data into this area, BIOS will show a warning message on screen and alarm beep.	Default
	Enabled		

3-2.2 Cache Memory Options

	Setting	Description	Note
CPU Internal Cache	Disabled		
	Enabled	Enables the CPU's internal cache.	Default
External Cache	Disabled		
	Enabled	Enables the external memory.	Default

3-2.3 Floppy Driver Settings

	Setting	Description	Note
Swap Floppy Drive	Disabled		Default
	Enabled	Changes the sequence of A and B drives.	

3-2.4 Boot Up Floppy Seek

	Setting	Description	Note
Boot Up Floppy Seek	Disabled	Seeks disk drives during boot up.	
	Enabled	Disabling speeds boot up.	Default

3-2.5 Boot Up NumLock Status

	Setting	Description	Note
Boot Up NumLock Status	On	Puts numeric keypad in NumLock mode at boot-up.	Default
	Off	Puts numeric keypad in arrow key mode at boot-up.	
Boot Up System Speed	High	Boots at default CPU speed.	Default
	Low	Boots at AT bus speed.	

3-2.6 Gate A20 Options

	Setting	Description	Note
Gate A20 Options	Normal	Lets chipset control GateA20.	
	Fast	A pin in the keyboard controller controls GateA20.	Default

3-2.7 Typematic Settings

Typematic Settings	Setting	Description	Note
Typematic Rate Setting	Disabled	Keystrokes repeat at a rate determined by the keyboard.	Default
	Enabled	When enabled , the typematic rate and typematic delay can be selected.	
The following [Typematic Rate] and [Typematic Delay] fields are active only if [Typematic Rate Setting] is set to [Enabled]			
Typematic Rate	6 (Char/sec)	Choose the rate at which a character is repeated when holding down a key.	Default
	8 (Char/sec)		
	10 (Char/sec)		
	12 (Char/sec)		
	15 (Char/sec)		
	20 (Char/sec)		
	24 (Char/sec)		
30 (Char/sec)			

Typematic Settings	Setting	Description	Note
Typematic Delay	250 (msec)	Choose how long after you press a key down the character begins repeating.	Default
	500 (msec)		
	750 (msec)		
	1000 (msec)		

3-2.8 Security Option

Use this feature to prevent unauthorized system boot-up or use of BIOS Setup. The following table describes the security settings.

	Setting	Description	Note
Security Option	System	Each time the system is booted, the password prompt appears.	
	Setup	If a password is set, the password prompt only appears when you attempt to enter the BIOS Setup program.	Default

3-2.9 Other Control Options

Other Control Options	Setting	Description	Note
OS Select for DRAM>64MB	OS2	When using an OS2 operating system.	
	Non-OS2	When using another, non-OS2 operating system.	Default
Report No FDD For WIN 95	No	Windows will release IRQ line 6 (normally used by the Floppy Disk Drive) after you disable your on-board FDD and set this field to [Yes].	Default
	Yes	Windows will reserve INT 6 for your FDD, whether it is disabled or not.	
Video BIOS Shadow	Disabled		
	Enabled	The BIOS is shadowed in a 16K segment if it is enabled and if it has BIOS present. These 16 segments can be shadowed from ROM to RAM. BIOS shadow copies BIOS code from slower ROM to faster RAM. BIOS can then execute from RAM.	Default

3-3 ADVANCED CHIPSET FEATURES



Caution: Change these settings only if you are already familiar with the Chipset.

The [Advanced Chipset Features] option changes the values of the chipset registers. These registers control the system options in the computer.

CMOS Setup Utility – Copyright (C) 1984-2001 Award Software
Advanced Chipset Features

<table style="width: 100%; border-collapse: collapse;"> <tr><td style="width: 35%;">DRAM CAS Select</td><td style="width: 35%;">2.5 (DDR) / 3 (SDR)</td><td style="width: 30%;"></td></tr> <tr><td>Dram Performance</td><td>Normal</td><td></td></tr> <tr><td>AT Bus Clock</td><td>CLK2/4</td><td></td></tr> <tr><td>System BIOS Cacheable</td><td>Disabled</td><td></td></tr> <tr><td>AGP Aperture Size</td><td>128M</td><td></td></tr> <tr><td>AGP Delay Offset</td><td>Auto</td><td></td></tr> <tr><td>AGP Driving Strength</td><td>Auto</td><td></td></tr> <tr><td>Memory Hole At 15M-16M</td><td>Disabled</td><td></td></tr> <tr><td>I/O Recovery Period</td><td>1 us</td><td></td></tr> <tr><td>Passive Release</td><td>Disabled</td><td></td></tr> </table>	DRAM CAS Select	2.5 (DDR) / 3 (SDR)		Dram Performance	Normal		AT Bus Clock	CLK2/4		System BIOS Cacheable	Disabled		AGP Aperture Size	128M		AGP Delay Offset	Auto		AGP Driving Strength	Auto		Memory Hole At 15M-16M	Disabled		I/O Recovery Period	1 us		Passive Release	Disabled		<table style="width: 100%; border-collapse: collapse;"> <tr><td style="text-align: center;">Item Help</td></tr> <tr><td style="text-align: center;">Menu Level ▶</td></tr> </table>	Item Help	Menu Level ▶
DRAM CAS Select	2.5 (DDR) / 3 (SDR)																																
Dram Performance	Normal																																
AT Bus Clock	CLK2/4																																
System BIOS Cacheable	Disabled																																
AGP Aperture Size	128M																																
AGP Delay Offset	Auto																																
AGP Driving Strength	Auto																																
Memory Hole At 15M-16M	Disabled																																
I/O Recovery Period	1 us																																
Passive Release	Disabled																																
Item Help																																	
Menu Level ▶																																	

↑↓→←:Move Enter:Select +/-/PU/PD:Value F10:Save ESC:Exit F1:General Help
 F5:Previous Values F6:Fail-Safe Defaults F7: Optimized Defaults

After you have completed the changes, press [Esc] and follow the instructions on your screen to save your settings or exit without saving. The following table describes each field in the Advanced Chipset Features Menu and how to configure each parameter.

CHIPSET FEATURES SETUP (Continued)

CHIPSET FEATURES	Setting	Description	Note
DRAM CAS Select	Auto (By SPD)	When synchronous DRAM is installed, the number of clock cycles of CAS latency depends on the DRAM timing. Do not reset this field from the default value specified by the system designer.	Default
	2.5 (DDR) / 3 (SDR)		
	2 (DDR) / 2 (SDR)		
DARM Performance	Auto (By SPD)	This item allow you to control the DRAM timing.	Default
	Failsafe		
	Slow		
	Normal		
	Fast		
	Ultra		
	Ultra2		
AT Bus Clock	7.16 MHz	This item allow you to control the ISA Bus clock.	Default
	CLK2/2		
	CLK2/3		
	CLK2/4		
	CLK2/5		
	CLK2/6		
System BIOS Cacheable	Disabled	The ROM area F0000H-FFFFFH is cacheable.	Default
	Enabled		

CHIPSET FEATURES SETUP (Continued)

CHIPSET FEATURES	Setting	Description	Note
AGP Aperture Size	128M	Select the size of Accelerated Graphics Port (AGP) aperture. The aperture is portion of the PCI memory address range dedicated for graphics memory address space. Host cycles that hit the aperture range are forwarded to the AGP without any translation.	Default
	4M, 8M, 16M, 32M, 128M, 256M.		
AGP Delay Offset	Auto	This item allows you to adjust the AGP delay offset.	Default
	+1~+7		
	- 1~ 7		
AGP Driving Strength	Auto	This item allows you to adjust the AGP Driving force.	Default
	Low		
	Mid		
	High		
Memory Hole At 15M-16M	Disabled	Some interface cards will map their ROM address to this area. If this occurs, select [Enabled] in this field.	Default
	Enabled		
I/O Recovery Period	1us	This item allows you to control the I/O Recovery Period.	Default
	2us		
	3us		
Passive Release	Disabled	If enabled this item can allow PCI arbiter to grant to another PCI master during DMA master access.	Default
	Enabled		

3-4 INTEGRATED PERIPHERALS



Caution: Change these settings only if you are already familiar with the Chipset.

The [INTEGRATED PERIPHERALS] option changes the values of the chipset registers. These registers control the system options in the computer. The following screen shows setup default settings.

CMOS Setup Utility – Copyright (C) 1984-2001 Award Software Integrated Peripherals	
On-Chip Primary IDE	Enabled ▲
Master PIO	Auto
Slave PIO	Auto
Master Ultra DMA	Auto
Slave Ultra DMA	Auto
On-Chip Secondary IDE	Enabled
Master PIO	Auto
Slave PIO	Auto
Master Ultra DMA	Auto
Slave Ultra DMA	Auto
On-Chip USB Controller	Enabled
USB Keyboard Support	Disabled
Init Display First	AGP
IDE HDD Block Mode	Enabled
Onboard FDC Controller	Enabled
Onboard Serial Port 1	3F8/IRQ4
Onboard Serial Port 2	2F8/IRQ3
Onboard Serial Port 3	Disabled
xUART Mode Select	IrDA
xRx/D , Tx/D Active	Hi, Lo
xIR Duplex Mode	Half
xFast IR Mode Use DMA	1
Onboard Parallel Port	378/IRQ7
Parallel Port Mode	SPP
xECP Mode Use DMA	3

Item Help

Menu Level ▶

↑↓→←: Move Enter: Select +/-/PU/PD: Value F10: Save ESC: Exit F1: General Help
 F5: Previous Values F6: Fail-Safe Defaults F7: Optimized Defaults

The following tables describe each field in the INTEGRATED PERIPHERALS Menu and provide instructions on how to configure the IDE controls, FDC controls, and the onboard serial and parallel ports.

3-4.1 IDE Device Controls

IDE Controls	Setting	Description	Note
On-Chip PCI IDE	Disabled	Turn off the on-board IDE	
	Enabled	Use the on-board IDE	Default
<ul style="list-style-type: none"> ➤ Primary ➤ Secondary 			
IDE	mode 0-4	0 is the slowest speed 4 is the fastest speed	
<ul style="list-style-type: none"> ➤ Primary Master PIO ➤ Primary Slave PIO ➤ Secondary Master PIO ➤ Secondary Slave PIO 	Auto	For better performance and stability, we suggest you use the Auto setting to set the HDD control timing.	Default
IDE	Disabled		
<ul style="list-style-type: none"> ➤ Primary Master UDMA ➤ Primary Slave UDMA ➤ Secondary Master UDMA ➤ Secondary Slave UDMA 	Auto	Select Auto to enable Ultra DMA Mode support.	Default
On-Chip USB Controller	Enabled	This should be enabled if your system has a USB installed on the system board and you want to use it. Even when so equipped, if you add a higher performance controller, you will need to disable this feature.	Default
	Disabled		
USB Keyboard Support	Disabled		Default
	Enabled	Select <i>Enabled</i> if your system contains a Universal Serial Bus (USB) controller and you have a USB keyboard.	

3-4.2 Keyboard Controls

Keyboard Controls	Setting	Description	Note
Init Display First	PCI Slot	Choose which card – AGP	
	AGP	Display card or PCI VGA card – to initialize first.	Default

3-4.3 IDE HDD Block Mode

	Setting	Description	Note
IDE HDD Block Mode	Disabled		
	Enabled	Invokes multi-sector transfer instead of one sector per transfer. Not all HDDs support this function.	Default

3-4.4 FDD Controls

FDD Controls	Setting	Description	Note
Onboard FDC controller	Disabled	Turn off the on-board floppy controller	
	Enabled	Use the on-board floppy controller	Default

3-4.5 Onboard Serial Ports

Onboard Serial Ports	Setting	Description	Note
Onboard Serial Port 1 / Serial Port 2 / Serial Port 3	Disabled		Default (port 3)
	3F8/IRQ4	Choose serial port 1 & 2's I/O address.	Default (port 1)
	2F8/IRQ3	Do not set port 1 & 2 to the same address except for	Default (port 2)
	3E8/IRQ4	Disabled or Auto.	
	2E8/IRQ3		
	Auto		

UART Mode Select	IrDA	The second serial port offers these InfraRed interface modes.	Default
	ASKIR		
	TFDS6000		
	HSDL3600		
	HSDL1100		
RxD, TxD Active	Hi, Hi	This item allow you to determine the active RxD, TxD.	
	Hi, Lo		Default
	Lo, Hi		
	Lo, Lo		
If [UART Mode Select] is set to [IrDA]/[ASKIR]			
IR Duplex Mode	Half	Choose [Half] or [Duplex] to set UR2 in half duplex mode or full duplex mode respectively. Refer to your IR device specifications to select the suitable mode.	Default
	Full		
Fast IR Mode Use DMA	1		Default
	3		

3-4.6 Onboard Parallel Ports

Onboard Parallel Ports	Setting	Description	Note
Onboard Parallel Port	Disabled	Choose the printer I/O address.	Default
	378/IRQ7		
	3BC/IRQ7		
	278/IRQ5		
Parallel Port Mode	EPP 1.9	The mode depends on your external device that connects to this port.	
	ECP		
	ECP+EPP1.9		
	SPP		Default
	EPP 1.7		
	ECP+EPP1.7		
If [Parallel Port Mode] is set to [ECP] mode			
ECP Mode use DMA	3	Choose DMA3	Default
	1	Choose DMA1	
If [Parallel Port Mode] is set to [EPP] mode			

3-5 POWER MANAGEMENT SETUP

The [POWER MANAGEMENT SETUP] sets the system's power saving functions.

CMOS Setup Utility – Copyright (C) 1984-2001 Award Software
 Power Management Setup

ACPI Suspend Type S1 (POS) Power Management User Define PM Control by APM No MODEM Use IRQ 3 Video Off In Suspend Yes Video Off Method DPMS PM Timers HDD Power Down Disabled Suspend Mode Disabled *** PowerOn \ WakeUp Function *** Soft-Off by PWR-BTTN Instant-Off WakeUp\PowerOn by PCI Card Disabled USB Dev WakeUp From S3-S5 Disabled Resume by Alarm Disabled x Date (of Month) Alarm 0 x Time (hh : mm : ss) Alarm 0 : 0 : 0 *** Suspend Break Events *** IRQ[1] (Keyboard) Enabled IRQ[3] Disabled IRQ[4] Disabled IRQ[5] Disabled IRQ[6] (Floppy Disk) Enabled IRQ[7] Disabled IRQ8J (RTC) Disabled IRQ[9] Disabled IRQ[10] Disabled IRQ[11] Disabled IRQ[12] (PS2 Mouse) Enabled IRQ[14] (Primary IDE) Enabled IRQ[15] (Secondary IDE) Disabled	Item Help Menu Level ▶
---	-------------------------------

↑↓→←:Move Enter:Select +/-/PU/PD:Value F10:Save ESC:Exit F1:General Help
 F5:Previous Values F6:Fail-Safe Defaults F7: Optimized Defaults

After you have completed the Power Management Setup, press [Esc] to return to the Main Menu.

3-5.1 Power Management Controls

Power Management Controls	Setting	Description			Note
ACPI Suspend Type	S1(POS)	The system will enter the S1 state during suspend. (Low latency wake up)			Default
	S3(STR)				
Power Management	User Define	Lets you define the HDD and system power down times.			Default
		Doze timer	Standby timer	Suspend timer	HDD power down
	Min Saving	1 Hour	1 Hour	1 Hour	15 Min
	Max Saving	1 Min	1 Min	1 Min	1 Min
PM Control by APM	Yes	When enabled, an Advanced Power Management device will be activated to enhance the Max. Power Saving mode and stop the CPU internal clock. If Advance Power Management (APM) is installed on your system, selecting Yes gives better power savings.			Default
	NO				
Video Off Option	Suspend --> Off	When enabled, this feature allows the VGA adapter to operate in a power saving mode.			Default
	Always On All Modes --> Off				
Video Off Method	V/H Sync+Blank	Selects the method by which the monitor is blanked.			Default
	Blank screen				
	DPMS				

HDD Power Down	Disabled		Default
	1-15 Min	When the set time has elapsed, BIOS sends a command to the HDD to power down. This turns off the HDD motor.	Some older model HDDs may not support this advanced function.
Suspend Mode	Disabled		Default
	1 Min - 1 Hour	In Suspend mode, the CPU stops completely (no instructions are executed.)	Only an SL-Enhanced (or SMI) CPU can enter this mode.

Power Management Controls (Continued)

Power Management Controls	Setting	Description	Note
Soft-Off by PWR-BTTN	Instant-off		Default
	Delay 4 Sec.	Turns off the system power 4 seconds after pushing the power button.	
Wake up \ Power On by PCI Card	Disabled	If enabled any PCI interrupt will wake up the system.	Default
	Enabled		
Wake up \ Power by Ring	Disabled	An input signal on the serial Ring Indicator (RI) line (in other words, an incoming call on the modem) awakens the system from a soft off state.	Default
	Enabled		
USB Dev Wake up From S3-S5	Disabled	If enabled this item can use A USB device to wake up system from S3-S5.	Default
	Enabled		
Resume by Alarm	Disabled	The system ignores the alarm.	Default
	Enabled	Set alarm to power on the system by the date (1-31) or time (hh:mm:ss). If the date is set to [0], the system will self-power on by alarm everyday at the set time.	

IRQ[1] (Keyboard)	Enabled	Select enabled that will wake up your system when in one of sleep modes.	Default
	Disabled		
IRQ[3]	Enabled	Select enabled that will wake up your system when in one of sleep modes.	Default
	Disabled		
IRQ[4]	Enabled	Select enabled that will wake up your system when in one of sleep modes.	Default
	Disabled		
IRQ[5]	Enabled	Select enabled that will wake up your system when in one of sleep modes.	Default
	Disabled		
IRQ[6] (floppy Disk)	Enabled	Select enabled that will wake up your system when in one of sleep modes.	Default
	Disabled		
IRQ[7]	Enabled	Select enabled that will wake up your system when in one of sleep modes.	Default
	Disabled		
IRQ[8] (RTC)	Enabled	Select enabled that will wake up your system when in one of sleep modes.	Default
	Disabled		
IRQ[9]	Enabled	Select enabled that will wake up your system when in one of sleep modes.	Default
	Disabled		
IRQ[10]	Enabled	Select enabled that will wake up your system when in one of sleep modes.	Default
	Disabled		
IRQ[11]	Enabled	Select enabled that will wake up your system when in one of sleep modes.	Default
	Disabled		
IRQ[12] (PS2 Mouse)	Enabled	Select enabled that will wake up your system when in one of sleep modes.	Default
	Disabled		

IRQ[14]	Enabled	Select enabled that will wake up your system when in one of sleep modes.	Default
	Disabled		
IRQ[15] (Secondary IDE)	Enabled	Select enabled that will wake up your system when in one of sleep modes.	Default
	Disabled		

3-6 PNP/PCI CONFIGURATION SETUP

This option sets the Motherboard's PCI Slots.

CMOS Setup Utility – Copyright (C) 1984-2001 Award Software
 PnP/PCI Configurations

PNP OS Installed	NO	Item Help
Reset Configuration Data	Disabled	
Resources Controlled By	Auto (ESCD)	Menu Level ▶
x IRQ Resources	Press Enter	
PCI/VGA Palette Snoop	Disabled	
Assign IRQ For VGA	Enabled	
Assign IRQ For USB	Enabled	
PCI IRQ Activd By	Level	

↑↓→←:Move Enter:Select +/-/PU/PD:Value F10:Save ESC:Exit F1:General Help
 F5:Previous Values F6:Fail-Safe Defaults F7: Optimized Defaults



Note: Starred (*) items will disappear when the [Resources Controlled By] option is set to [Auto].

After you have completed the PCI Slot Configuration, press [Esc] and follow the instructions on your screen to save your settings or exit without saving.

3-6.1 PNP/PCI Configuration Controls

PNP/PCI Controls	Setting	Description	Note
PnP OS Installed	Yes	Set this field to [Yes] if you are running Windows 95, which is PnP compatible.	
	No	If the OS you are running does not support PnP configuration.	Default (If there is any doubt, set this field to [No])
Reset Configuration Data	Disabled	Retain PnP configuration data in BIOS.	Default
	Enabled	Reset PnP configuration data in BIOS.	
Resources Controlled By	Manual	BIOS does not manage PCI/ISA PnP card IRQ assignment. Requires to assign IRQ-# and DMA-# to PCI or ISA PnP manually. IRQ-3,4,5,7,9,10,11,12,14,15 assigned to: _ DMA-0,1,3,5,6,7 assigned to: _	
	Auto (ESCD)	The Plug-and-Play BIOS auto manages PCI/ISA PnP card IRQ assignment automatically.	Recommended
If [Resources Controlled By] is set to [Manual]			
IRQ-3,4,5,7,9,11,12,14,15 assigned to	PCI Device	This item allow you to assign IRQ to PCI Device or reserved.	Default
	Reserved		

PNP/PCI Configuration Setup (Continued)

PNP/PCI Setup	Setting	Description	Note
Your OS may reassign another interrupt to a PCI slot after BIOS passes control to the OS, especially if you use Windows 95, 98 or NT.			
PCI/VGA Palette Snoop	Disabled	Leave this field at <i>Disabled</i> .	Default
	Enabled		
Assign IRQ For VGA/USB	Disabled	BIOS will assign IRQ for VGA/USB port.	
	Enabled	BIOS won't assign IRQ for VGA/USB port.	Default
PCI IRQ Active By	Edge	This item allow you to determine which win ACTIVATE PCI IRQ.	
	Level		Default

3-6.2 MULTI I/O ADDRESSES

Default settings for multi-I/O addresses are as follows:

Port	I/O Address	IRQ	Status
LPT1	378H	7	ECP/EPP
COM1	3F8H	4	
COM2	2F8H	3	



Warning: If a default I/O address conflicts with other I/O cards such as sound card, you must change one of the I/O addresses to remedy to this address conflict. (I/O addresses can be adjusted from the BIOS Setup Utility)

3-7 PC HEALTH STATUS

This option sets the Motherboard's PC Health Status.

CMOS Setup Utility – Copyright (C) 1984-2001 Award Software
 PC Health Status

CPU Warning Temperature	Disabled	Item Help Menu Level ▶
Current SYS Temperature	31 °C / 87 °F	
Current CPUFAN Speed	4247 RPM	
Current CHAFAN Speed	0 RPM	
Vcore	1.71 V	
+3.3V	3.32 V	
+5V	4.92 V	
+12V	12.47 V	
Shutdown Temperature	75 °C / 167 °F	

↑↓→←:Move Enter:Select +/-/PU/PD:Value F10:Save ESC:Exit F1:General Help
 F5:Previous Values F6:Fail-Safe Defaults F7: Optimized Defaults



Note: Starred (*) items will disappear when the [Resources Controlled By] option is set to [Auto].

3-7.1 CPU Device Monitoring

CPU Device Monitoring	Setting	Description	Note
CPU Warning Temperature	Disabled	Set CPU temperature from 50°C to 70°C. The CPU will slow down when CPU temperature goes beyond the preset value. The CPU will continue to run slow until the temperature returns back within the safe range.	Default
	50°C/122°F		
	53°C/127°F		
	56°C/133°F		
	60°C/140°F		
	63°C/145°F		
	70°C/158°F		
Current Sys Temperature	°C/°F	Show the current status of the system temperature.	
Current CPU Temperature	°C/°F	Show the current status of CPU temperature.	
Current CPUFAN/ CHAFAN Speed	°C/°F	Show the current status of CPU Fan.	
Vcore, 2.5V, 3.3V, 5V, 12V	V	Show the current voltage status.	
Shutdown Temperature	60°C/140°F	Set the maximum allowable CPU temperature, before the system shutdown.	
	65°C/149°F		
	70°C/158°F		
	75°C/167°F		Default

3-8 LOAD FAIL-SAFE DEFAULTS

Select the [Load Fail-Safe Defaults] option from the Main Menu to load the system values you have previously saved. This option is recommended if you need to reset the system setup and to retrieve the old values.

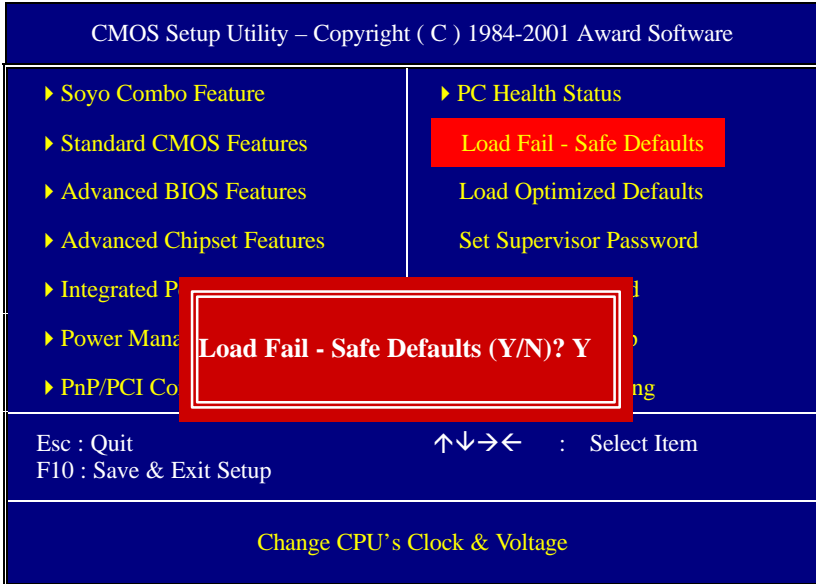

Type [Y] to use the Setup Defaults followed by [Enter] or otherwise [N] to return to the Main Menu and keep current values.



Warning: If you run into any problem after changing the BIOS configuration, please load the FAILSAFE DEFAULTS for stable performance.

3-9 LOAD OPTIMIZED DEFAULTS

Select the [Load Optimized Defaults] option from the Main Menu to load the system values you have previously saved. This option is recommended if you need to reset the system setup and to retrieve the old values.

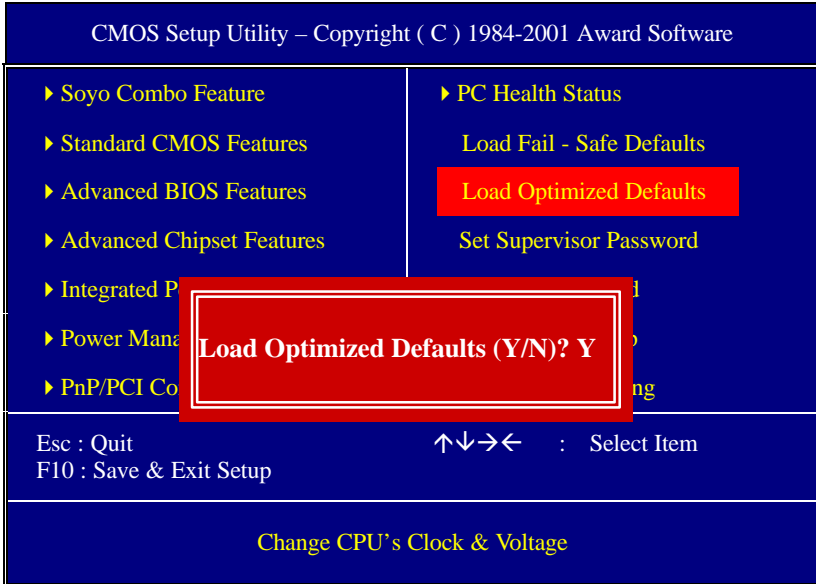

Type [Y] to use the Setup Defaults followed by [Enter] or otherwise [N] to return to the Main Menu and keep current values.



Warning: If you run into any problem after changing the BIOS configuration, please load the FAILSAFE DEFAULTS for stable performance.

3-10 SUPERVISOR PASSWORD

Based on the setting you have made in the [Security Option] of the [BIOS FEATURES SETUP] section, the password prevents access to the system or the setup program by unauthorized users. Follow this procedure to set a new password or disable the password:

1. Choose [BIOS FEATURES SETUP] in the Main Menu and press [Enter]. Select the [Security Options] item and set the field to:
 - a. [System]: The password is required every time the system is booted. This means only a person who knows the password can use this computer.
 - b. [Setup]: The password is required only when you attempt to enter the BIOS Setup program.
2. Choose [SUPERVISOR PASSWORD] from the Main Menu and press [Enter]. The following prompt appear:

Enter Password:



Warning: If you forget or lose the password, the only way to access the system is to set jumper JP5 to clear the CMOS RAM. All setup information is lost and you must run the BIOS setup program again.



Note: If you do not wish to use the password function, press [Enter] directly and the following message appears:

Password Disabled!!

3. Enter your new password and press [Enter]. The following message appears, prompting to confirm the new password:

Confirm Password:

4. Re-enter your password and then press [Enter] to exit to the Main Menu.

This diagram outlines the password selection procedure:

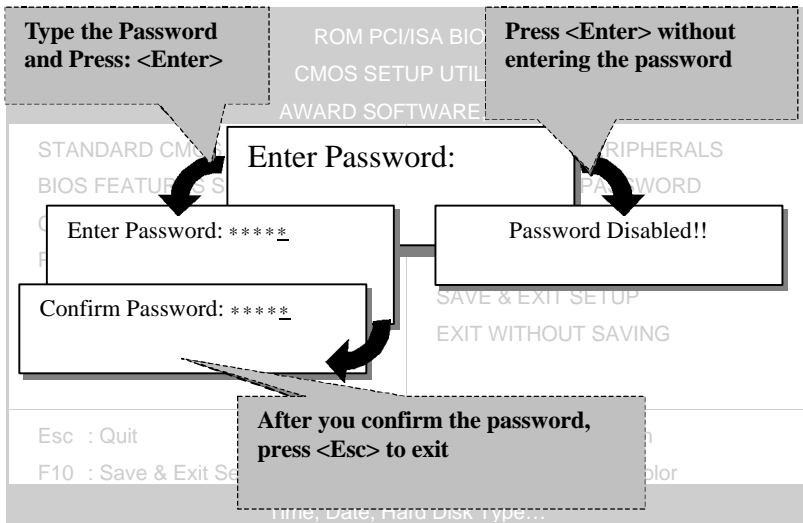

3-11 USER PASSWORD

When the user password option is on, you are not allowed to change any setting in the [CMOS SETUP UTILITY] except for changing the user's password.

The password setting procedure is similar to that for the [SUPERVISOR PASSWORD] (Refer to section 3-9).

3-12 IDE HDD AUTO DETECTION

This Main Menu function automatically detects the hard disk type and configures the [Standard CMOS Features] accordingly.

CMOS Setup Utility – Copyright (C) 1984-2001 Award Software
 IDE Primary Master

IDE HDD Auto-Detection Press Enter IDE Primary Master Auto Capacity 0 MB Access Mode Auto 0 Cylinder 0 Head 0 Precomp 0 Landing Zone 0 Sector 0	Item Help Menu Level ▶
---	-------------------------------

↑↓→←:Move Enter:Select +/-/PU/PD:Value F10:Save ESC:Exit F1:General Help
 F5:Previous Values F6:Fail-Safe Defaults F7: Optimized Defaults



Note: This function is only valid for IDE type of hard disk drives.

3-13 BOOT MENU

Boot Menu enables user to boot-up on different boot device without going into the BIOS setup.

To enable boot Menu, press “ESC” after memory initialization, user will see a device menu, in which user can choose the device they wish to boot from.

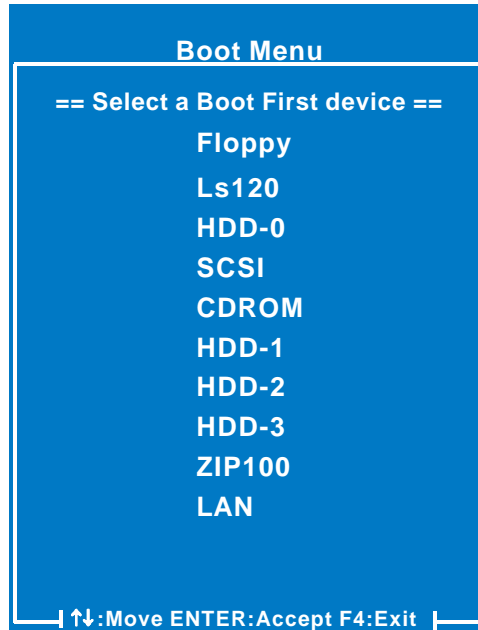

Chapter 4

DRIVER INSTALLATION

Your SY-K7ADA Motherboard comes with a CD-ROM labeled "SOYO CD." The SOYO CD contains the user's manual file for your new Motherboard, the drivers software available for installation, and a database in HTML format with information on SOYO Motherboards and other products.

Step 1. Insert the SOYO CD into the CD-ROM drive

If you use Windows NT, the SOYO-CD will not detect your motherboard type. In that case the following dialog will pop up, please choose your motherboard and press OK. Now the SOYO-CD Start Up Menu will be shown.

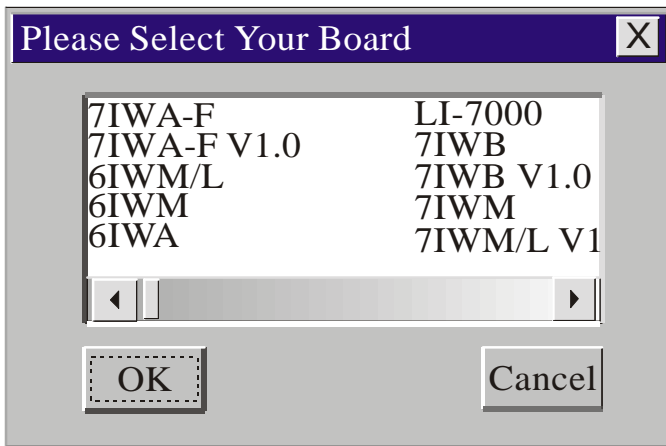

(SOYO CD Start Up Program Menu)

If you use Windows 95 or 98, the SOYO CD Start Up Program automatically detects which SOYO Motherboard you own and displays the corresponding model name.



The user's manual files included on the SOYO CD are in PDF (Postscript Document) format. In order to read a PDF file, the appropriate Acrobat Reader software must be installed in your system.

Note: The Start Up program automatically detects if the Acrobat Reader utility is already present in your system, and otherwise prompts you on whether or not you want to install it. You must install the Acrobat Reader utility to be able to read the user's manual file. Follow the instructions on your screen during installation, then once the installation is completed, restart your system and re-run the SOYO CD.

Step 2. Install Drivers

Click the **Install Drivers** button to display the list of drivers software that can be installed with your Motherboard. The Start Up program displays the drivers available for the particular model of Motherboard you own. We recommend that you only install those drivers.

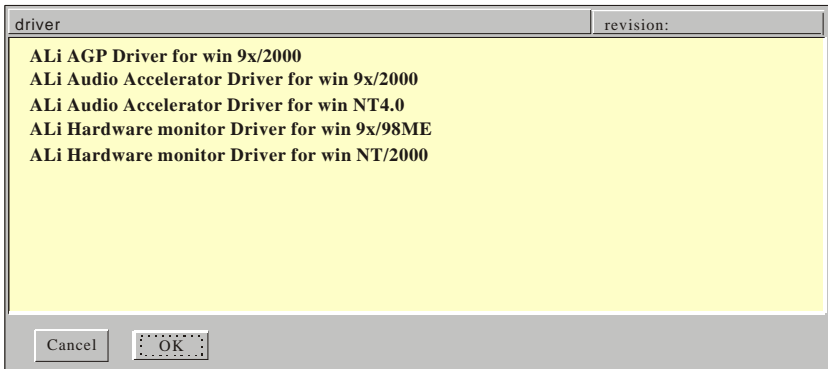

(Driver Installation Menu)

A short description of all available drivers follows:

➤ **ALi AGP driver for Win 9x/2000**

The ALi AGP driver package includes all drivers your motherboard needs. After selecting this driver package, one driver will be installed automatically. A description of the 2 drivers follows:

—ALi IDE Driver

This driver will speed up the data-transfer rate to and from the harddisk.

—ALi AGP Driver

This driver must be installed in order to be able to make use of the on-board AGP Video functionality.

➤ **ALi Audio Accelerator Driver for Win 9x/NT/2000**

You have to install the drivers before installing any application for the Audio Accelerator.

➤ **ALi Audio Accelerator Driver for Win NT4.0**

You have to install the drivers before installing any application for the Audio Accelerator.

➤ **ALi hardware monitor for Win 9x/98ME**

Your motherboard comes with a hardware monitoring IC. By installing this utility Temperature, Fan speed and Voltages can be monitored. It is also possible to set alarms when current system values exceed or fall below pre-set values.

➤ **ALi hardware monitor for Win NT/2000**

Your motherboard comes with a hardware monitoring IC. By installing this utility Temperature, Fan speed and Voltages can be monitored. It is also possible to set alarms when current system values exceed or fall below pre-set values.

Select which driver you want to install and click **OK**, or click **Cancel** to abort the driver installation and return to the main menu.

Note: Once you have selected a driver, the system will automatically exit the SOYO CD to begin the driver installation program. When the installation is complete, most drivers require to restart your system before they can become active.

Step 3. Select which driver you want to install and click OK

Notice 1: Once you have selected a driver, the system will automatically exit the SOYO CD to begin the driver installation program. When the installation is complete, most drivers require to restart your system before they can become active.

Notice 2: You may click **Cancel** to abort the driver installation and return to the main menu.

Step 4.

1.For supporting S3 mode wake up function in WINDOWS 98se, please download

the driver from SOYO web site (www.soyo.com.tw).

Please put this downloaded driver in c:\windows\system32\driver and remove USB

device in “Device Manager” then refresh.

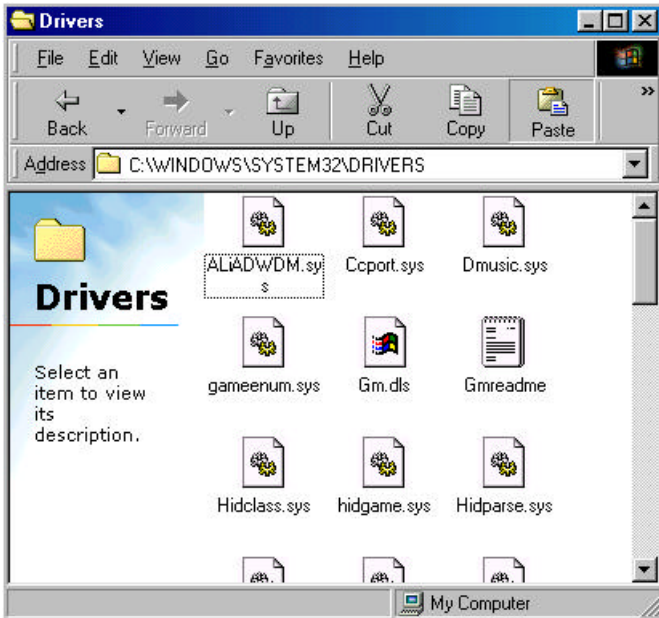

Please put this downloaded driver in c:\windows\system32\driver

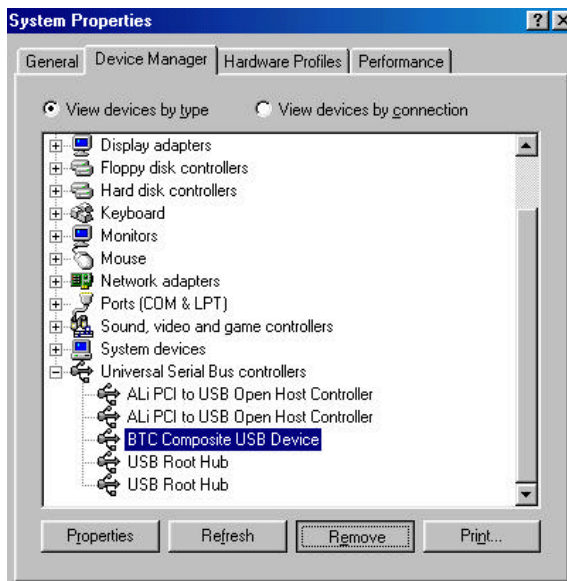

Remove USB device(ex : USB keyboard, mouse, ..etc.)

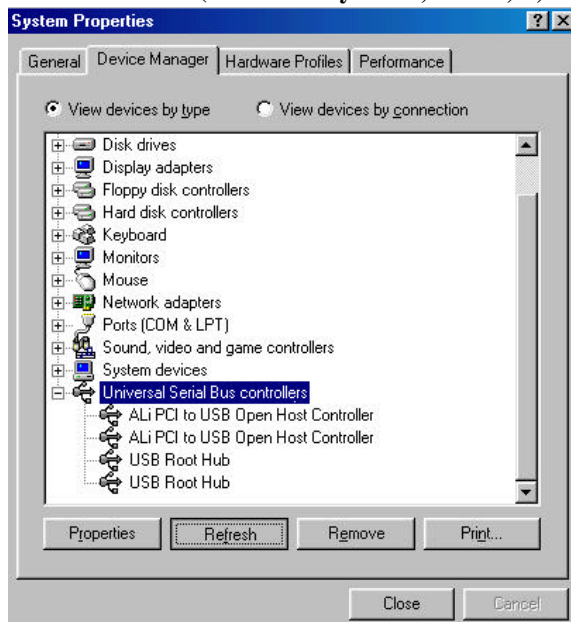

Refresh

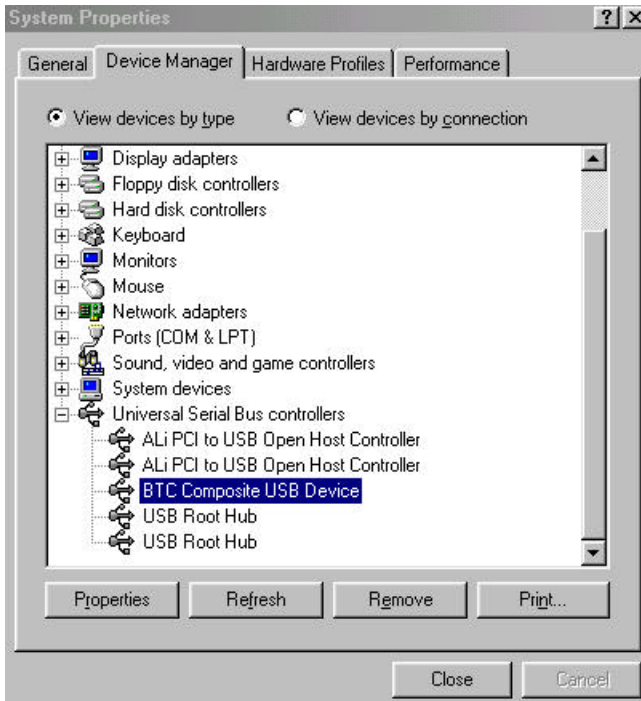

Final

2.If customer uses the WINDOWS 95 OSR2, please use the NT version driver when installing audio driver.

3.Right now, ALI chipset does not support ATI RAGE 128 graphics chip, so K7ADA can not support this kind of VGA card.

Step 5. Check the Latest Releases

Click the 'Check the latest Releases' button to go the SOYO Website to automatically find the latest BIOS, manual and driver releases for your motherboard. This button will only work if your computer is connected to the internet through a network or modem connection. Make sure to get your modem connection up before clicking this button.

