

# MS - 5169

## ATX AL9 Mainboard

Supports Intel Pentium® Processor  
with MMX™ Technology

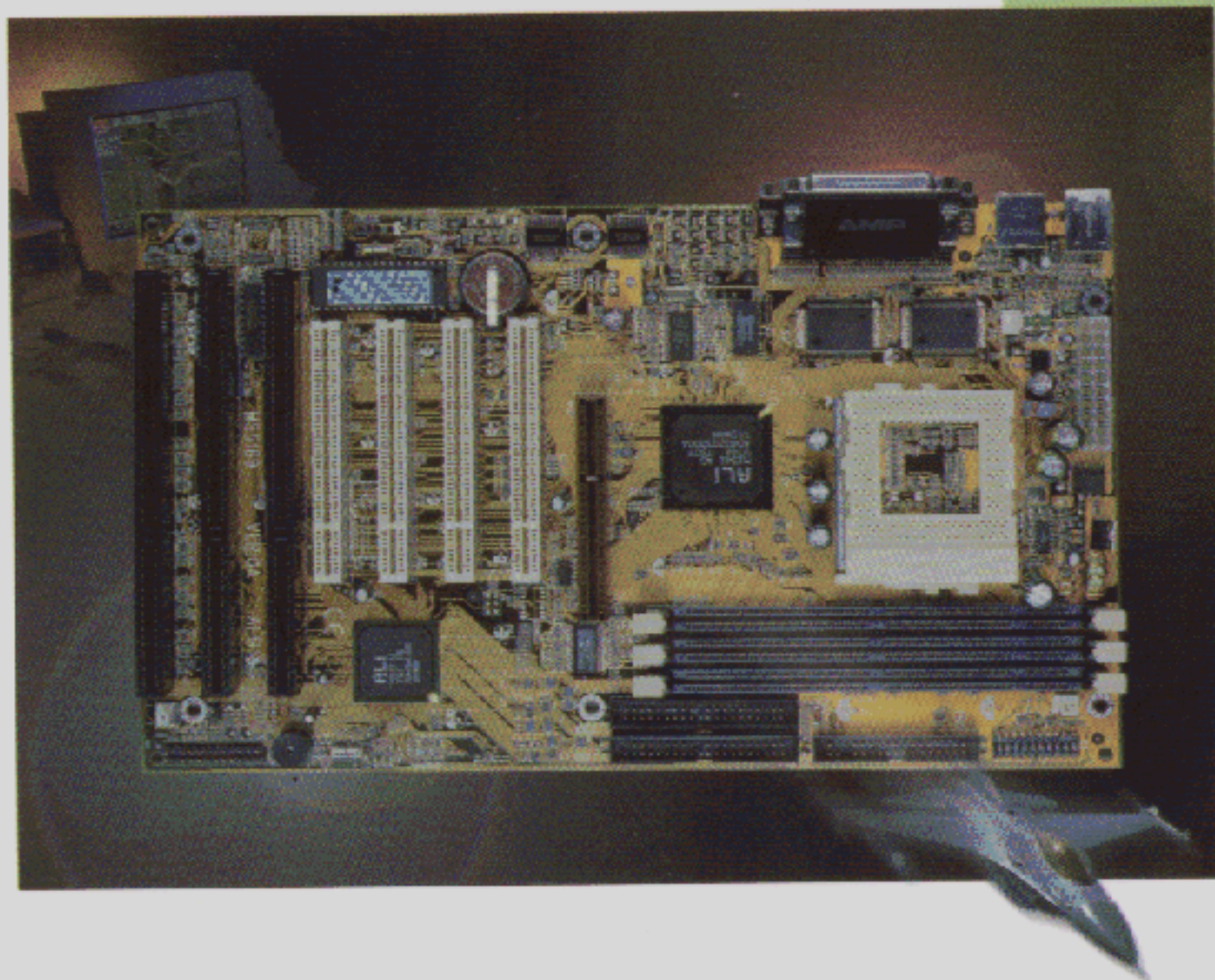

# *User's Manual*

- The specification is subject to change without notice.
- Pentium is a registered trademark of Intel Corporation.
- MMX is a trademark of Intel Corporation.
- All brand names are registered trademarks of their respective owners.



Manual Rev: 2.1  
Release Date: July 1998



### **FCC-B Radio Frequency Interference Statement**

This equipment has been tested and found to comply with the limits for a class B digital device, pursuant to part 15 of the FCC rules. These limits are designed to provide reasonable protection against harmful interference when the equipment is operated in a commercial environment. This equipment generates, uses and can radiate radio frequency energy and, if not installed and used in accordance with the instruction manual, may cause harmful interference to radio communications. Operation of this equipment in a residential area is likely to cause harmful interference, in which case the user will be required to correct the interference at his own expense.

#### **NOTICE 1**

The changes or modifications not expressly approved by the party responsible for compliance could void the user's authority to operate the equipment.

#### **NOTICE 2**

Shielded interface cables and AC power cords, if any, must be used in order to comply with the emission limits.

**VOIR LA NOTICE D'INSTALLATION AVANT DE  
RACCORDER AU RESEAU.**

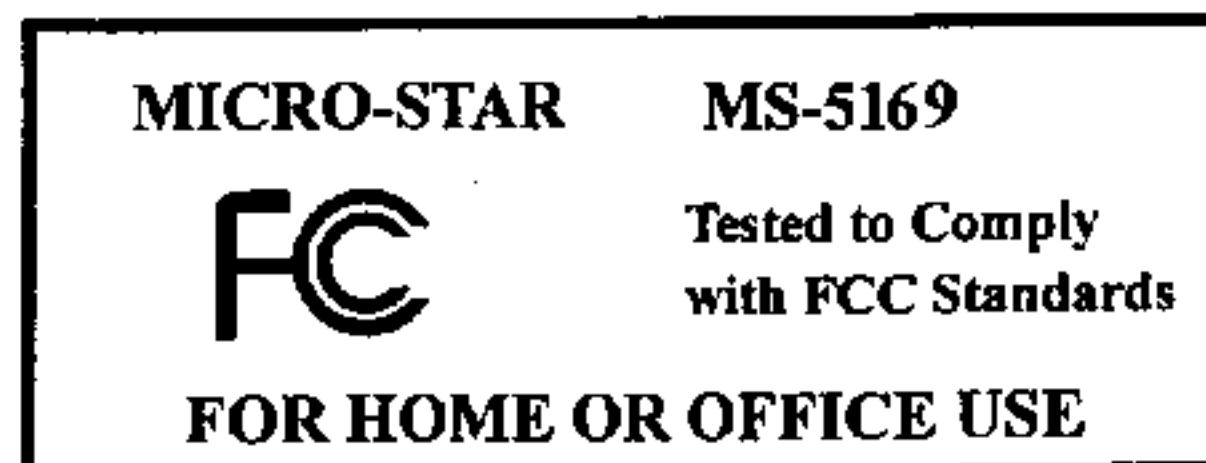

**Edition  
July 1998**

#### **Copyright Notice**

The material in this document is the intellectual property of **MICRO-STAR INTERNATIONAL**. We take every care in the preparation of this document, but no guarantee is given as to the correctness of its contents. Our products are under continual improvement and we reserve the right to make changes without notice.

#### **Trademarks**

All trademarks used in this manual are the property of their respective owners.

Intel and Pentium are registered trademarks of Intel Corporation.  
PS/2 and OS/2 are registered trademarks of IBM Corporation.  
Windows 95 and Windows NT are registered trademarks of Microsoft.  
Netware is a registered trademark of Novell.  
Award is a registered trademark of Award Software Inc.  
AMD is a registered trademark of AMD.  
Cyrix is a registered trademark of Cyrix.

## Table of Contents

<b>CHAPTER 1 INTRODUCTION</b> .....	1-1	<b>CHAPTER 3 AMI® BIOS USER'S GUIDE</b> .....	3-1
MAINBOARD FEATURES .....	1-2	ENTER BIOS SETUP .....	3-2
MAINBOARD LAYOUT .....	1-5	STANDARD CMOS SETUP .....	3-4
<b>CHAPTER 2 HARDWARE INSTALLATION</b> .....	2-1	ADVANCED CMOS SETUP .....	3-5
CENTRAL PROCESSING UNIT: CPU .....	2-1	ADVANCED CHIPSET SETUP .....	3-9
CPU INSTALLATION PROCEDURES .....	2-1	POWER MANAGEMENT SETUP .....	3-13
CPU CORE SPEED DERIVATION PROCEDURE .....	2-2	PCI/PLUG AND PLAY SETUP .....	3-17
CPU VOLTAGE SETTING: S2 .....	2-4	PERIPHERAL SETUP .....	3-21
CPU SINGLE OR DUAL VOLTAGE SETTING: JV1 .....	2-7		
CPU SPEED AND VOLTAGE SETTING: S1, S2 & JV1 .....	2-8		
FAN POWER CONNECTORS:			
JFAN1/JSFAN1/JPFAN1 .....	2-14		
MEMORY INSTALLATION .....	2-15		
MEMORY BANK CONFIGURATION .....	2-15		
MEMORY INSTALLATION PROCEDURES .....	2-16		
MEMORY POPULATION RULES .....	2-17		
CASE CONNECTOR: JFP .....	2-19		
FLOPPY DISK CONNECTOR: FDC .....	2-21		
HARD DISK CONNECTORS: IDE1 & IDE2 .....	2-22		
ATX 20-PIN POWER CONNECTOR: JWR1 .....	2-23		
REMOTE POWER ON/OFF SWITCH: JRMS1 .....	2-24		
SERIAL PORT CONNECTORS: COM A & COM B .....	2-25		
PARALLEL PORT CONNECTOR: LPT .....	2-26		
KEYBOARD CONNECTOR: PSKBC .....	2-27		
MOUSE CONNECTOR: PSMSC .....	2-27		
USB CONNECTORS: USB .....	2-27		
EXTERNAL BATTERY CONNECTOR: JP10 .....	2-28		
POWER ON MODE FEATURE: JP11 .....	2-29		
GREEN BUTTON AND POWER SWITCH: JP1 .....	2-30		
		<b>CHAPTER 4 COMPATIBILITY TEST PROBLEM</b> .....	4-1

## Chapter 1

### INTRODUCTION

The ATX AL9 mainboard is a high-performance personal computer mainboard. This mainboard supports Intel® Pentium® processor/Pentium® processor with MMX™ technology, Cyrix® 6x86/6x86L/6x86MX, AMD® K5/K6/K6 2, and IDT C6™ processors. The mainboard also supports one AGP slot and four 32-bit PCI (Peripheral Component Interconnect) Local Bus standard slots.

The mainboard uses the highly integrated Aladdin® 5 chipset to support the PCI/ISA and Green standards, and to provide the Host/AGP bridge. The Aladdin® 5 chipset integrates all system control functions such as ACPI (Advanced Configuration and Power Interface). The ACPI provides more Energy Saving Features for the OSPM(OS Direct Power Management) function. The Aladdin® 5 chipset also improves the IDE transfer rate by supporting Ultra DMA/33 IDE that transfer data at the rate of 33MB/s.

The mainboard also supports the System Hardware Monitor as an optional function. This function includes: CPU/chassis/power fan monitor, CPU temperature detect and system voltage detect.

## 1.1 Mainboard Features

### CPU

- Socket 7 supports Intel® Pentium® processor/Pentium® processor with MMX™ technology.
- The Cyrix® 6x86/6x86L/6x86MX, AMD® K5/K6/K6 2 and IDT C6™ processors are also supported.

### Chipset

- Aladdin® 5 M1531/M1543 chipset.

### Clock Generator

- 100/95/83.3/75/66/60MHz clocks are supported.

### Cache Memory

- Supports 512K Pipelined Burst cache memory.
- Cacheable Area: 128/512 MB.

### Main Memory

- Supports six memory banks using three 168-pin unbuffered DIMM.
- Supports a maximum memory size of 768MB.
- Supports 3.3v Extended Data Output (EDO) and SDRAM DIMM.

### Slots

- One AGP(Accelerated Graphics Port) slot.
  - AGP specification compliant
  - AGP 66/133MHz 3.3v device support
- Four 32-bit Master PCI Bus slots and three 16-bit ISA bus slots
- Supports 3.3v/5v PCI bus Interface.

**On-Board IDE**

- An IDE controller on the Aladdin® M1543 PCI Chipset provides IDE HDD/CD-ROM with PIO, Bus Master and Ultra DMA/33 operation modes. Connect up to four IDE devices.

**Remote Control**

- Meet ACPI specifications.
- Power ON/OFF switch connector on-board.
- Soft Power-Off.
- Support modem ring wake-up .
- Support alarm wake-up.

**On-Board Peripherals**

- On-Board Peripherals include:
  - 1 floppy port supports 2 FDD with 360K, 720K, 1.2M, 1.44M and 2.88Mbytes.
  - 2 serial ports (COMA + COMB)
  - 1 parallel port supports SPP/EPP/ECP mode
  - 2 USB ports

**BIOS**

- The mainboard BIOS provides "Plug & Play" BIOS which detects the peripheral devices and expansion cards of the board automatically.
- The mainboard provides a Desktop Management Interface(DMI) function which records your mainboard specifications.

**Dimension**

- Standard ATX form factor
- 30cm(L) x 18.6cm(W) x 4 layer PCB

**Mounting**

- 6 mounting holes

**System Hardware Monitor (optional)**

- CPU Rotation Speed Control
- CPU Fan Control (the fan will automatically stop when the system enters suspend mode)
- CPU and Power Fan Control (reserved)
- System Voltage Detect
- Display Actual Current Voltage

1.2 Mainboard Layout

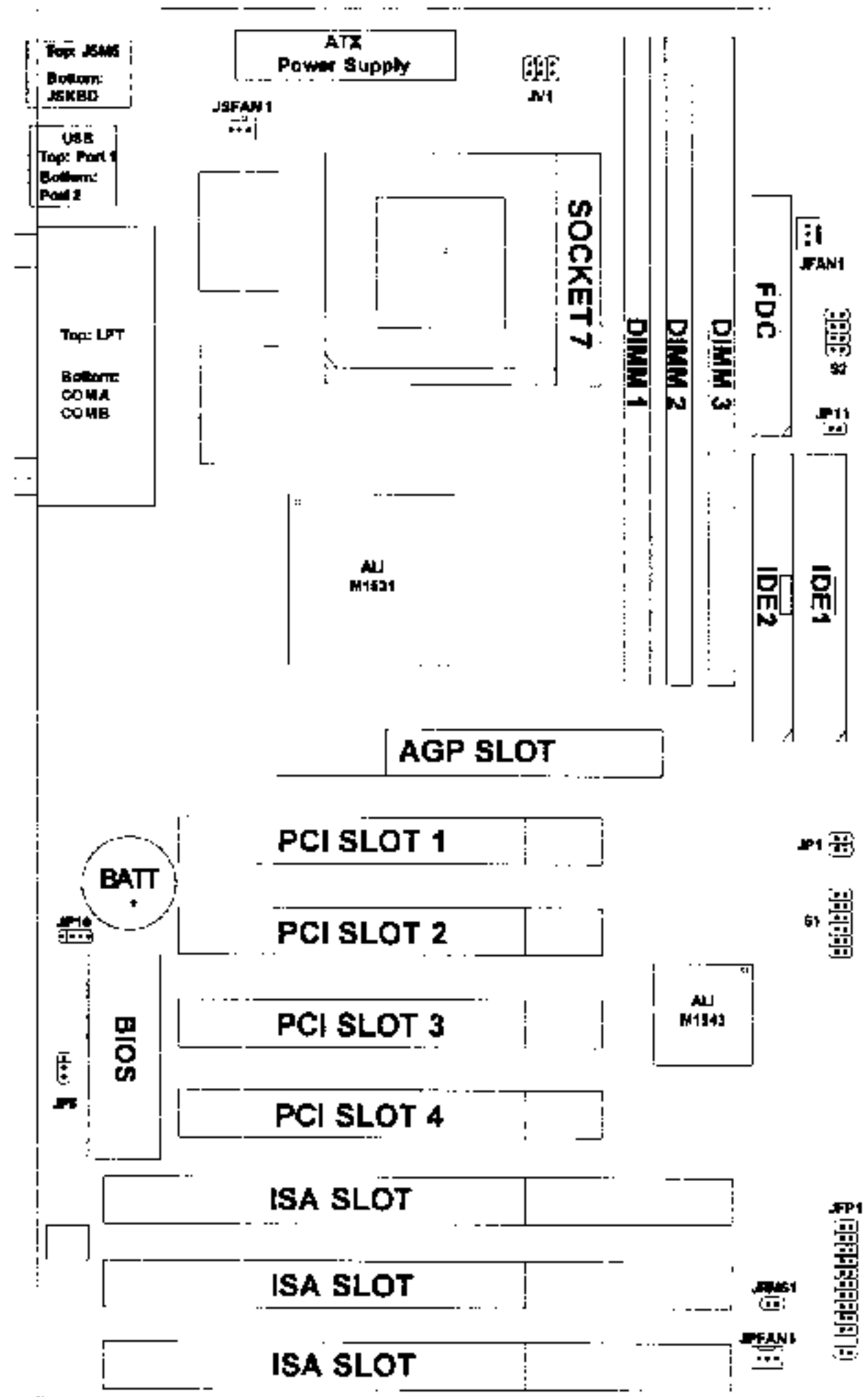

MS-5169

Chapter 2

HARDWARE INSTALLATION

2.1 Central Processing Unit: CPU

The ATX AL9 mainboard operates with Intel® Pentium® processor/ Pentium® processor with MMX™ technology, Cyrix® 6x86/6x86L/ 6x86MX, AMD® K5/K6/K6 2 and IDT C6™ processors. It could operate with 2.1V to 3.5V processors. The mainboard provides a 321-pin ZIF Socket 7 for easy CPU installation, a jumper switch (S1) to set the proper speed for the CPU and (S2) for setting the CPU voltage. The CPU should always have a cooling fan attached to prevent overheating.

2.1-1 CPU Installation Procedures

1. Pull the lever sideways away from the socket. Then, raise the lever up to a 90-degree angle.
2. Locate Pin 1 in the socket and look for the white dot or cut edge in the CPU. Match Pin 1 with the white dot/cut edge. Then, insert the CPU. It should insert easily.
3. Press the lever down to complete the installation.

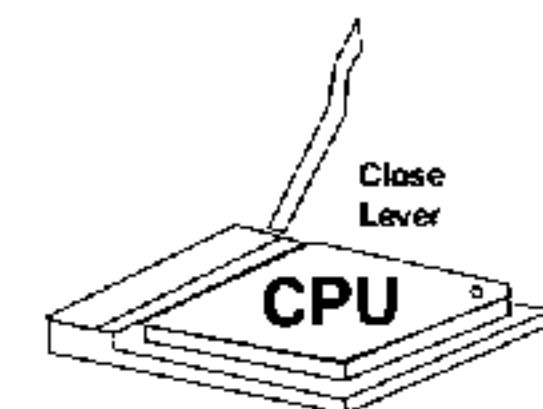
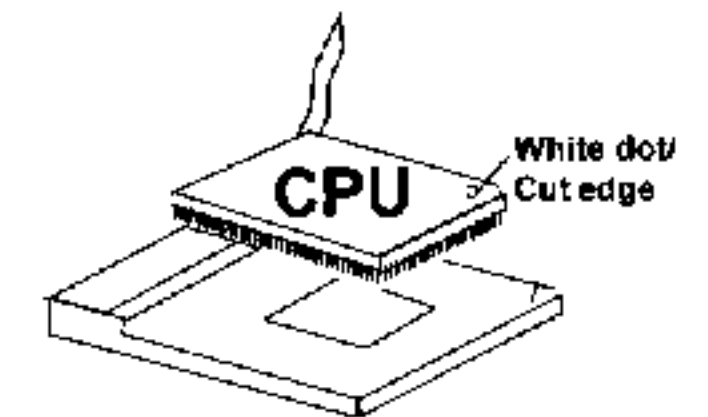
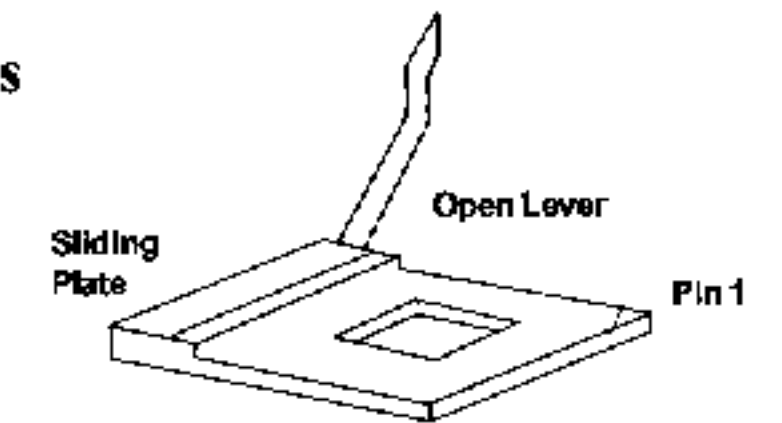

2.1-2 CPU Core Speed Derivation Procedure

1. The Jumper S1 (4, 5 & 6) is used to adjust the CPU clock frequency.

4	5	6	CPU Clock
0	0	0	100
0	0	1	75*
0	1	0	83
0	1	1	66
1	0	0	95
1	0	1	50
1	1	0	75**
1	1	1	60

\* AGP = 60/PCI = 30

\*\* AGP = 75/PCI = 37.5

0 = Open    1 = Short

2. The Jumper S1 (1, 2, and 3) is used to set the Core/Bus (Fraction) ratio of the CPU. The actual core speed of the CPU is the Host Clock Frequency multiplied by the Core/Bus ratio. For example:

$$\begin{aligned}
 \text{If } \text{CPU Clock} &= 66\text{MHz} \\
 \text{Core/Bus ratio} &= 3/2 \\
 \text{then CPU core speed} &= \text{Host Clock} \times \text{Core/Bus ratio} \\
 &= 66\text{MHz} \times 3/2 \\
 &= 100\text{MHz}
 \end{aligned}$$

1	2	3	CPU	
0	0	0	1.5/3.5	
0	1	0	3x	Intel AMD Cyrix IDT
1	0	0	2x	
1	1	0	2.5x	
0	0	1	5.5x	
0	1	1	5x	AMD K6/K6 2
1	0	1	4x	
1	1	1	4.5x	

0 = Open    1 = Short



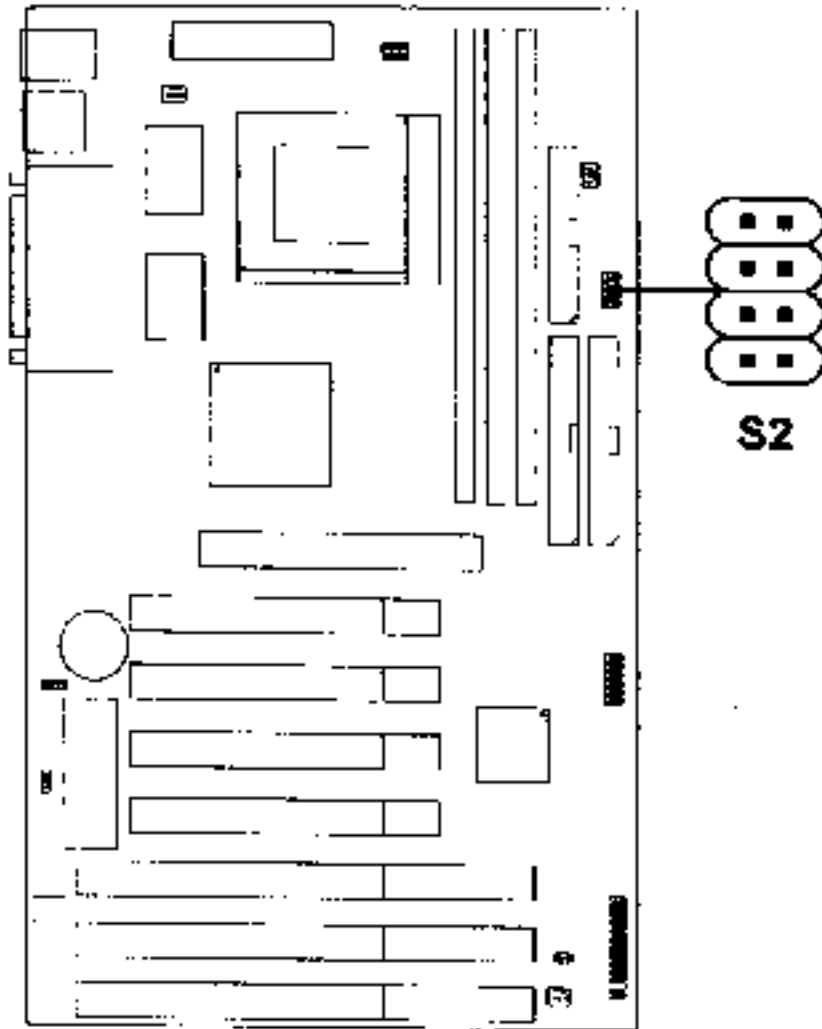

2.1-3 CPU Voltage Setting: S2



V I/O	Vcore	S2
3.45	3.6	
3.45	3.5	
3.45	3.4	
3.45	3.3	

V I/O	Vcore	S2
3.45	3.2	
3.45	3.1	
3.45	3.0	
3.45	2.9	
3.45	2.8	
3.45	2.7	
3.45	2.6	
3.45	2.5	





V I/O	Vcore	S2
3.45	2.4	
3.45	2.3	
3.45	2.2	
3.45	2.1	

**2.1-4 CPU Single or Dual Voltage Setting: JV1**

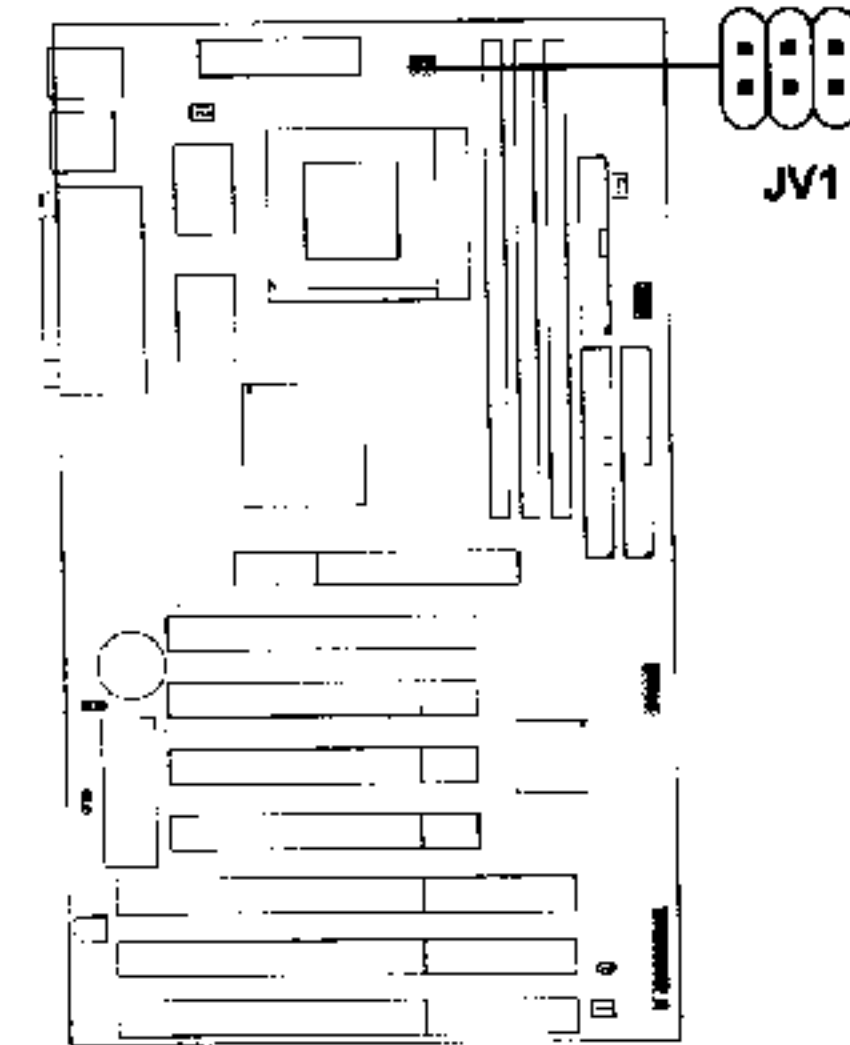
This jumper is used for setting the CPU single or Dual voltage.



JV1	CPU
	Single Voltage CPU
	Dual Voltage CPU

2.1-5 CPU Speed and Voltage Setting: S1, S2 and JV1

To set the proper speed and voltage of the CPU, you must know the specifications of your CPU (*always ask the vendor for CPU specifications*). Then refer to Table 2.1 (Intel® Processor), Table 2.2 (Cyrix® Processor), Table 2.3 (AMD® Processor) and Table 2.4 (IDT C6™) for proper setting.

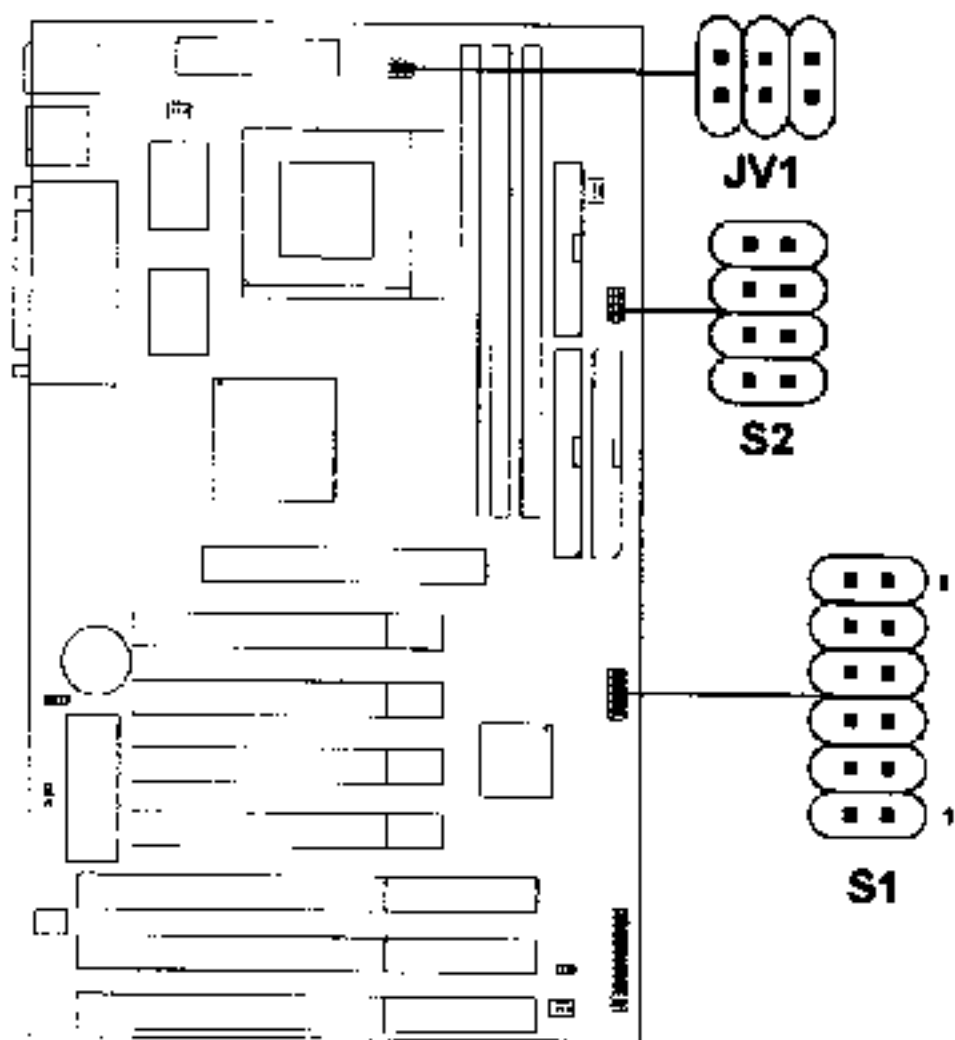

Table 2.1 Intel® Processor

a. Intel® Pentium® Processor

CPU Type	CPU Voltage		CPU Speed	
	VVO	Vcore	JV1	S1
100 MHz	3.38			
133 MHz	3.52			
166 MHz				
200 MHz				

b. Intel® Pentium® Processor with MMX™ Technology

166 MHz				
200 MHz	3.3 3.45	2.8		
233 MHz				

Note: If you encounter a CPU with different voltage, just go to Section 2.1-3 and look for the proper voltage settings.

Table 2.2 Cyrix® Processor

Cyrix® 6x86 processor uses PR to rate the speed of their processors based on Intel® Pentium® processor core speed. For example, PR150 (120MHz) has 150MHz core speed of Intel® Pentium® processor, but it has 120MHz core speed in Cyrix® processor. Cyrix® 6x86 processor should always use a more powerful fan (ask vendor for proper cooling fan).

a. Cyrix® 6x86/6x86L processor

CPU Type	CPU Voltage		CPU Speed		
	VVO	Vcore	JV1	S2	S1
6x86 PR166	3.5				
6x86L PR166	3.3 3.45	2.8			
6x86 PR200	3.5				
6x86L PR200	3.3 3.45	2.8			

b. Cyrix® 6x86MX Processor

CPU Type	CPU Voltage			CPU Speed	
	VVO	Vcore	JV1	S2	S1
PR200 (66 x 2.5)	3.3 3.45	2.9			
PR233 (75 x 2.5)					
(66 x 3)					
(83 x 2)					
PR266 (75 x 3)					
(66 x 3.5)					
(83 x 2.5)					

Note: If you encounter a CPU with different voltage, just go to Section 2.1-3 and look for the proper voltage settings.

Table 2.3 AMD® Processor

AMD® K5/K6 processor uses PR to rate the speed of their processors based on Intel® Pentium® processor core speed. For example, PR133(100MHz) has 133MHz core speed of Intel® Pentium® processor but has 100MHz core speed in AMD® processor.

a. AMD® K5 Processor

CPU Type	CPU Voltage			CPU Speed
	V <sub>IO</sub>	V <sub>core</sub>	V <sub>1</sub>	
PR100	3.52	3.52	3.52	
PR133				
PR166				

b. AMD® K6 Processor

CPU Type	CPU Voltage		V <sub>1</sub>	S2	CPU Speed	
	V <sub>IO</sub>	V <sub>core</sub>				
166MHz	3.3	2.9	3.52			
200MHz	3.45					
233MHz	3.3	3.2				
266MHz	3.45					
300MHz	3.45					
K6 2 300MHz	3.3	2.2				
K6 2 333MHz	3.45					
K6 2 350MHz	3.45					

Table 2.4 IDT Processor

IDT C6™ Processor

CPU Type	CPU Voltage			CPU Speed
	V <sub>IO</sub>	V <sub>core</sub>	V <sub>1</sub>	
200MHz	3.3	3.3	3.3	
225MHz				



**2.1-6 Fan Power Connectors: JFAN1, JSFAN1, & JPFAN1**

These connectors support system cooling fan with +12V. It supports three pin head connector. When connecting the wire to the connector, always take note that the red wire is the positive and should be connected to the +12V, the black wire is Ground and should be connected to GND. If your mainboard has System Hardware Monitor chipset on-board, you can use a specially designed fan w/ speed sensor to take advantage of System Hardware Monitor's CPU fan control.

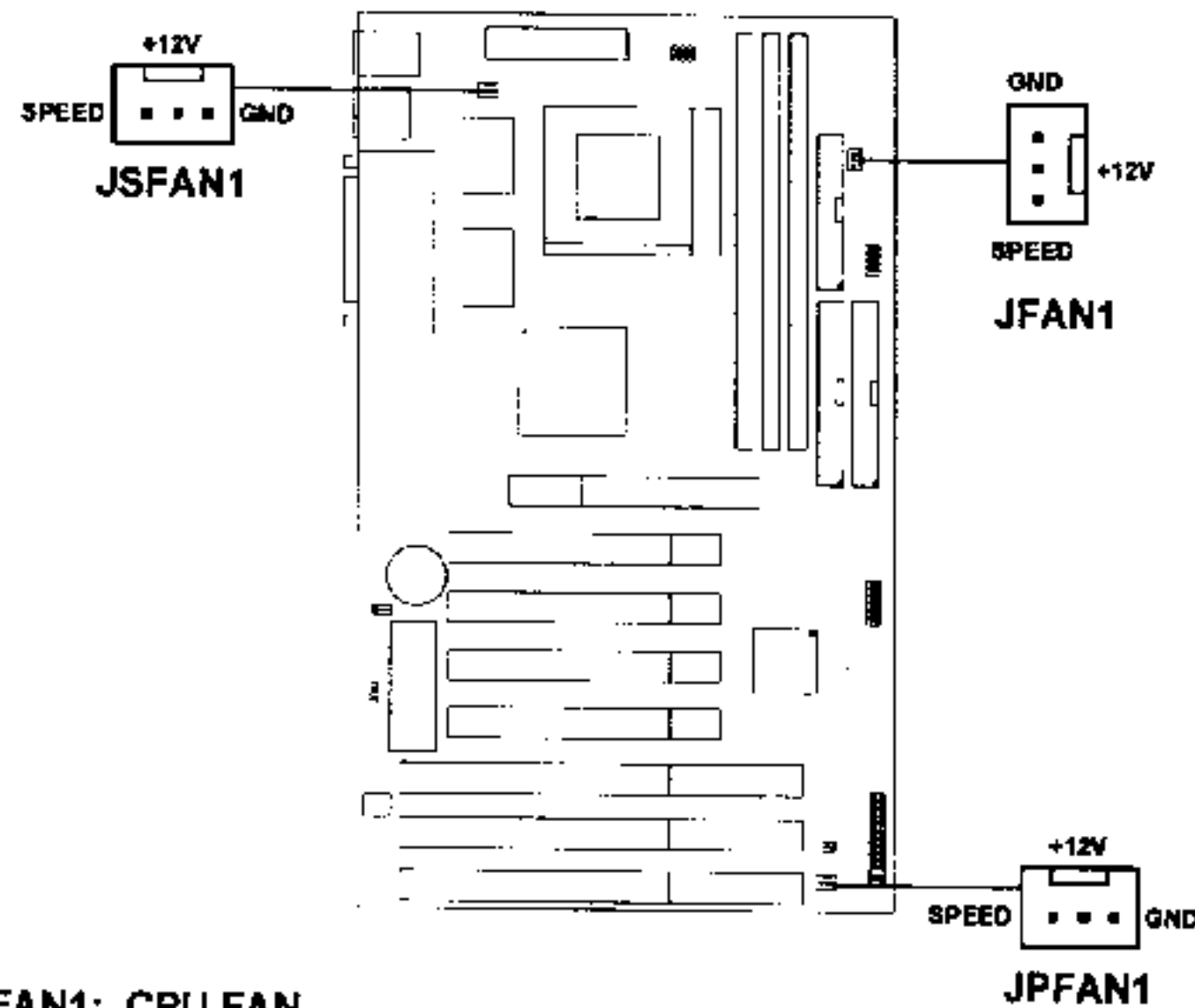

JFAN1: CPU FAN  
 JPFAN1: POWER FAN  
 JSFAN1: CHASSIS FAN

For fans with fan speed sensor, every rotation of the fan will send out 2 pulses. System Hardware Monitor will count and report the fan rotation speed.

**Note:** Always consult vendor for proper CPU cooling fan.

**2.2 Memory Installation**

**2.2-1 Memory Bank Configuration**

The mainboard provides three 168-pin DIMM(Double In-Line Memory) sockets. It supports six memory banks for a maximum of 768MB memory. You can use DIMM from 8MB, 16MB, 32MB, 64MB, 128MB to 256MB.

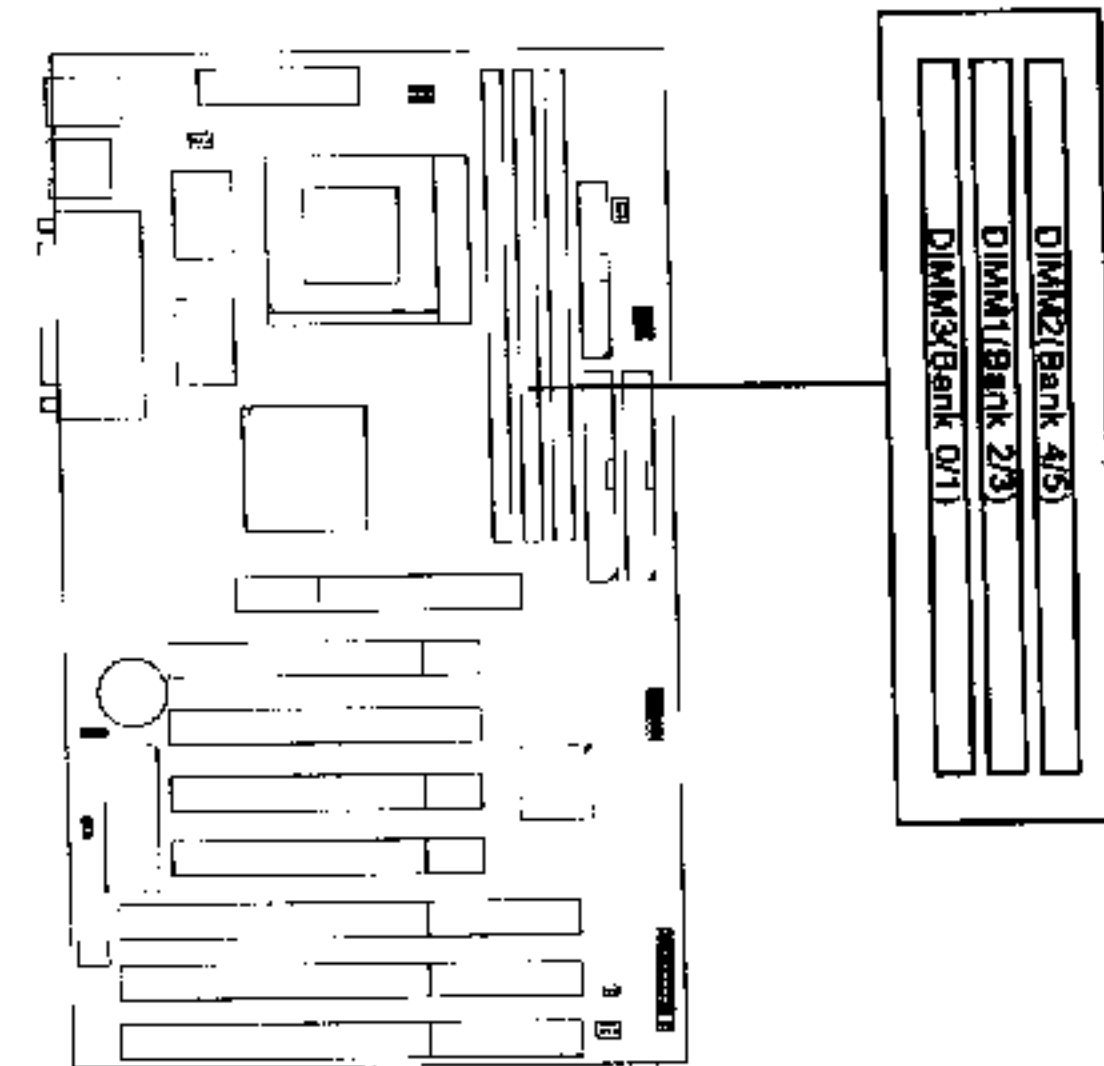



**WARNING!**

If you use 100 MHz CPU Bus Frequency, only PC100 DIMM Specs. is supported.

## 2.2-2 Memory Installation Procedures:

## A. How to install DIMM Module



Single Sided DIMM



Double Sided DIMM

1. The DIMM slot has two keys marked "VOLT" and "DRAM", so the DIMM memory module can only fit in one direction.
2. Insert the DIMM memory module vertically into the DIMM slot. Then, push it in.

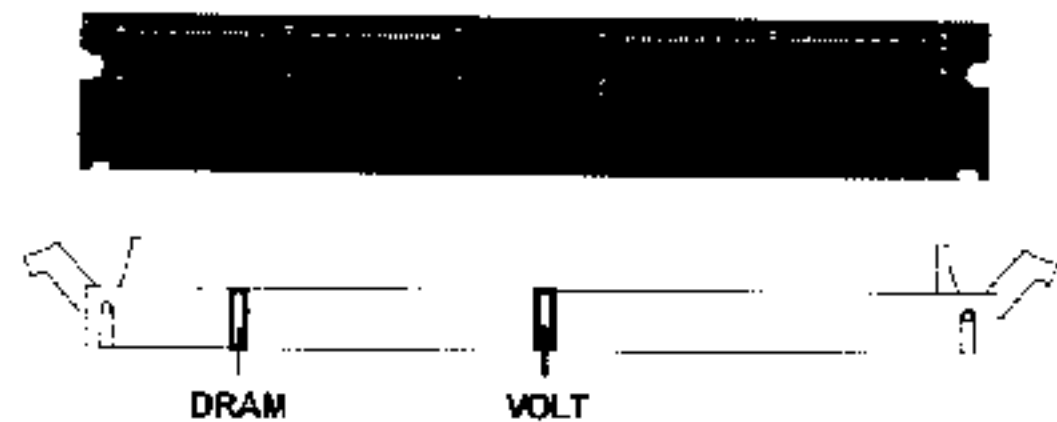

3. The plastic clip at the side of the DIMM slot will automatically close.

## 2.2-3 Memory Population Rules

1. This mainboard supports Table Free memory, so memory can be installed in DIMM1, DIMM2, or DIMM 3 in any order.
2. Use only 3.3v unbuffered DIMM.
3. The DRAM addressing and the size supported by the mainboard is shown next page.
4. Using 100MHz CPU Bus frequency, only PC100 DIMM is supported.

Table 2.2-1 EDO DRAM Memory Addressing

DRAM Tech.	DRAM Density & Width	DRAM Addressing	Address Size		MB/DIMM	
			Row	Column	Single no. Side(S) pcs.	Double no. Side(D) pcs.
16M	1Mx16	SYMM	10	10	8MBx4	16MBx8
	1Mx16	ASYM	12	8	8MBx4	16MBx8
	2Mx8	ASYM	11	10	16MBx8	32MBx16
	2Mx8	ASYM	12	9	16MBx8	32MBx16
	4Mx4	SYMM	11	11	32MBx16	64MBx32
64M	4Mx4	ASYM	12	10	32MBx16	64MBx32
	2Mx32	ASYM	11	10	16MBx2	32MBx4
	2Mx32	ASYM	12	9	16MBx2	32MBx4
	2Mx32	ASYM	13	8	16MBx2	32MBx4
	4Mx16	SYMM	11	11	32MBx4	64MBx8
	4Mx16	ASYM	12	10	32MBx4	64MBx8
	8Mx8	ASYM	12	11	64MBx8	128MBx16

Table 2.2-2 SDRAM Memory Addressing

DRAM Tech.	DRAM Density & Width	DRAM Addressing	Address Size		MB/DIMM	
			Row	Column	Single no. Side(S) pcs.	Double no. Side(D) pcs.
16M	1Mx16	ASYM	11	8	8MBx4	16MBx8
	2Mx8	ASYM	11	9	16MBx8	32MBx16
	4Mx4	ASYM	11	10	32MB	64MB
64M	2Mx32	ASYM	11	9	32MBx2	64MBx4
	2Mx32	ASYM	12	8	16MBx2	32MBx4
	4Mx16	ASYM	11	10	32MB	64MB
	4Mx16	ASYM	13	8	32MB	64MB
	8Mx8	ASYM	13	9	64MB	128MB
	16Mx4	ASYM	13	10	128MB	256MB
	64M	2Mx32	ASYM	11	8	
4Mx16		ASYM	12	8		
8Mx8		ASYM	12	9		
16Mx4		ASYM	12	10		

2.3 Case Connector: JFP

The Hardware Reset, Key Lock, Power LED, Speaker and HDD LED are all grouped in JFP connector block for easy installation.

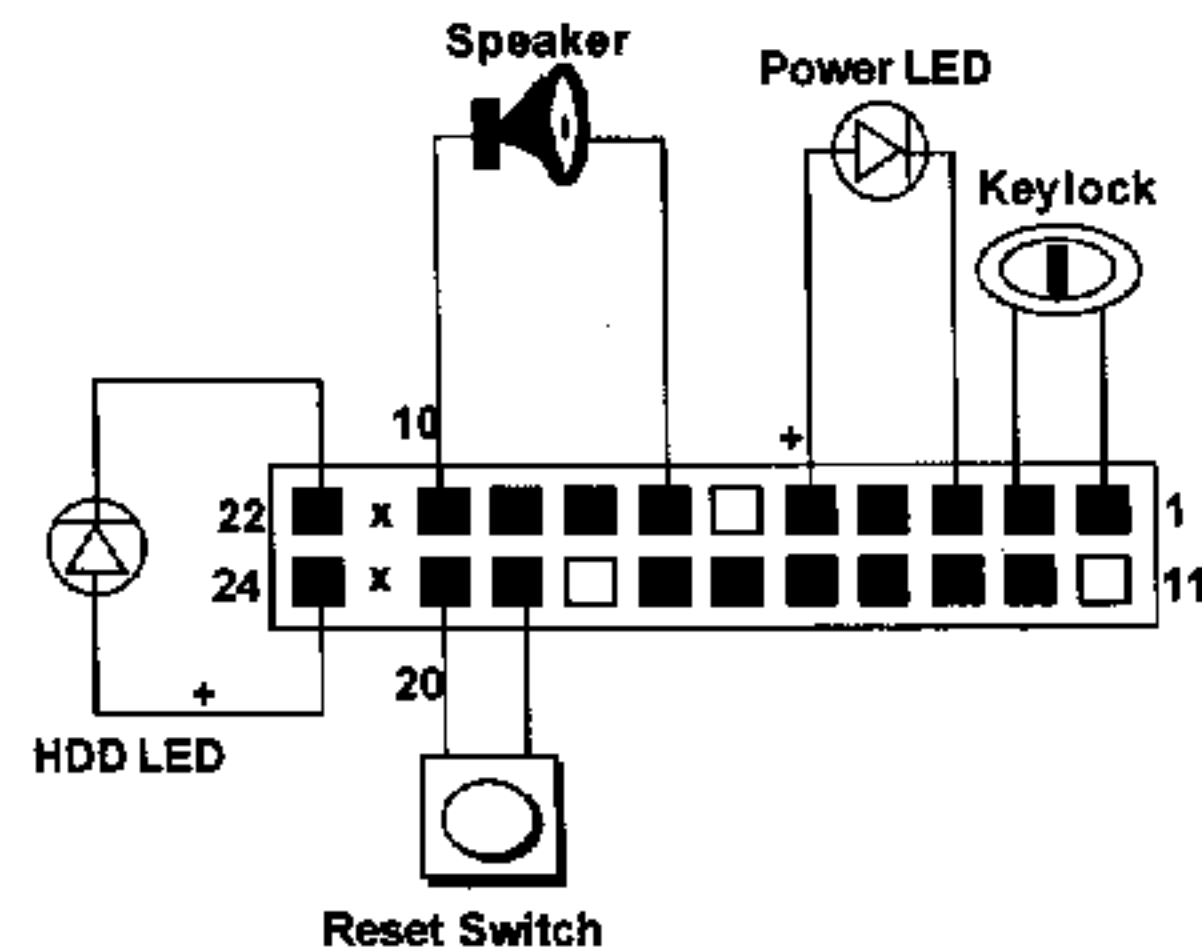
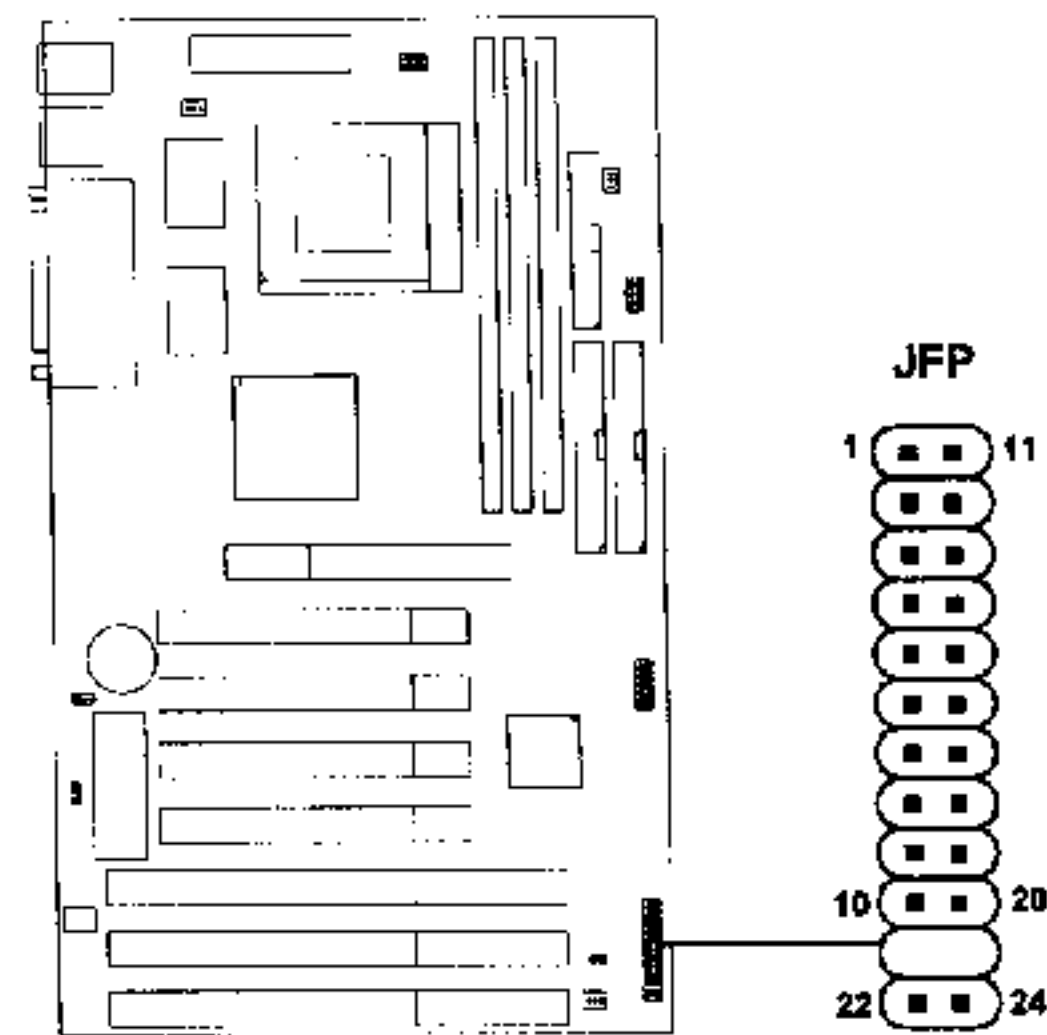

Figure 2.1

### 2.3-1 Hardware Reset

Reset switch is used to reboot the system rather than turning the power ON/OFF. Avoid rebooting the system when the HDD LED is lit. You can connect the Reset switch from the system case to this pin. (See Figure 2.1)

### 2.3-2 Keylock

Keylock allows you to disable the keyboard for security purposes. You can connect the keylock to this pin. (See Figure 2.1)

### 2.3-3 Power LED

The Power LED is always lit while the system power is on. You can connect the Power LED from the system case to this pin. (See Figure 2.1)

### 2.3-4 Speaker

Speaker from the system case is connected to this pin. (See Figure 2.1)

### 2.3-5 HDD LED

HDD LED shows the activity of a hard disk drive. Avoid turning the power off while the HDD led is lit. You can connect the HDD LED from the system case to this pin. (See Figure 2.1).

## 2.4 Floppy Disk Connector: FDC

The mainboard also provides a standard floppy disk connector, FDC that supports 360K, 720K, 1.2M, 1.44M and 2.88M floppy disk types. You can attach a floppy disk cable directly to this connector.

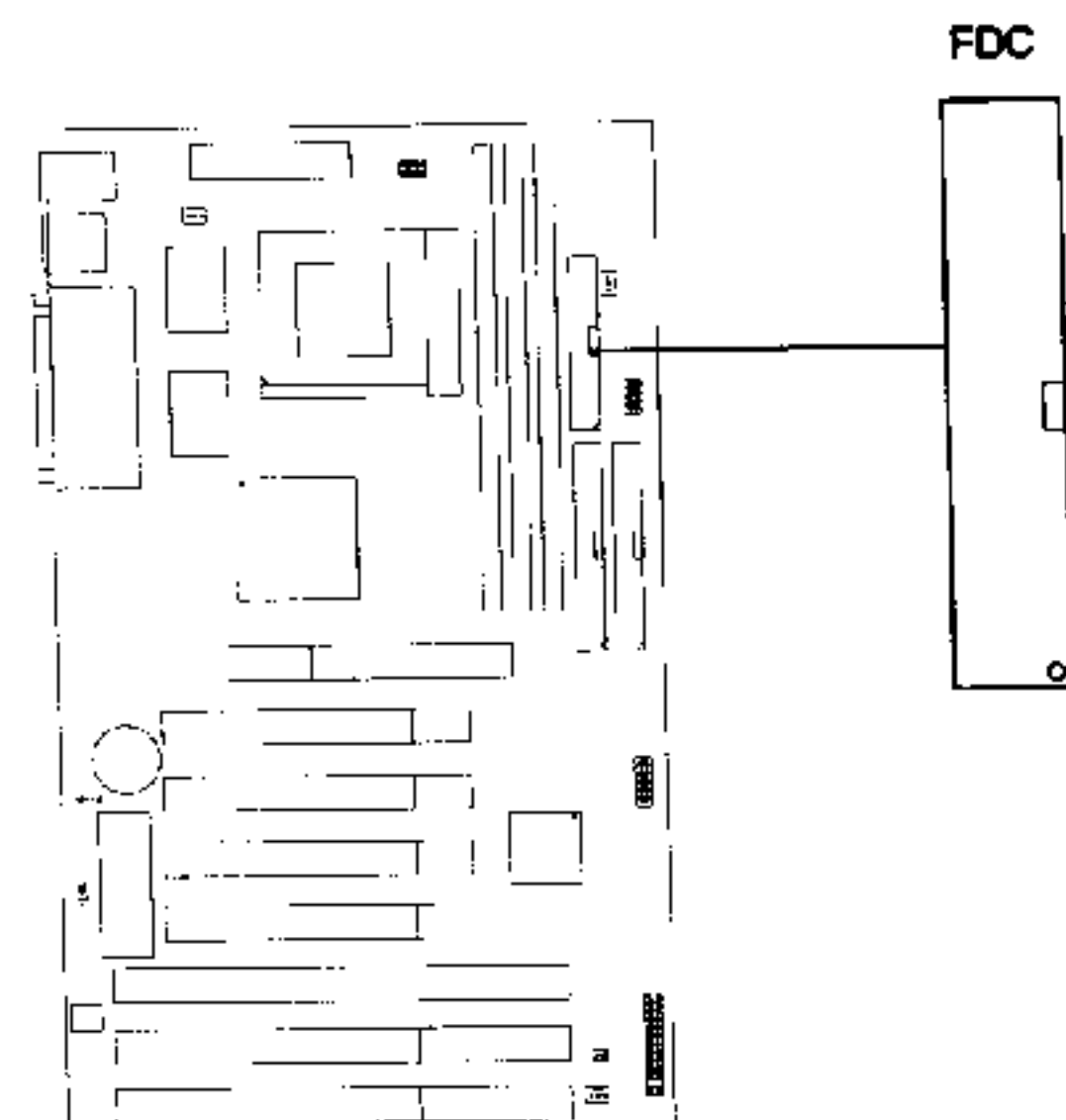



### 2.5 Hard Disk Connectors: IDE1 & IDE2

The mainboard has a 32-bit Enhanced PCI IDE Controller that provides two HDD connectors IDE1 (Primary) and IDE2 (Secondary). You can connect up to four hard disk drives, CD-ROM, 120MB Floppy and other devices to IDE1 and IDE2.

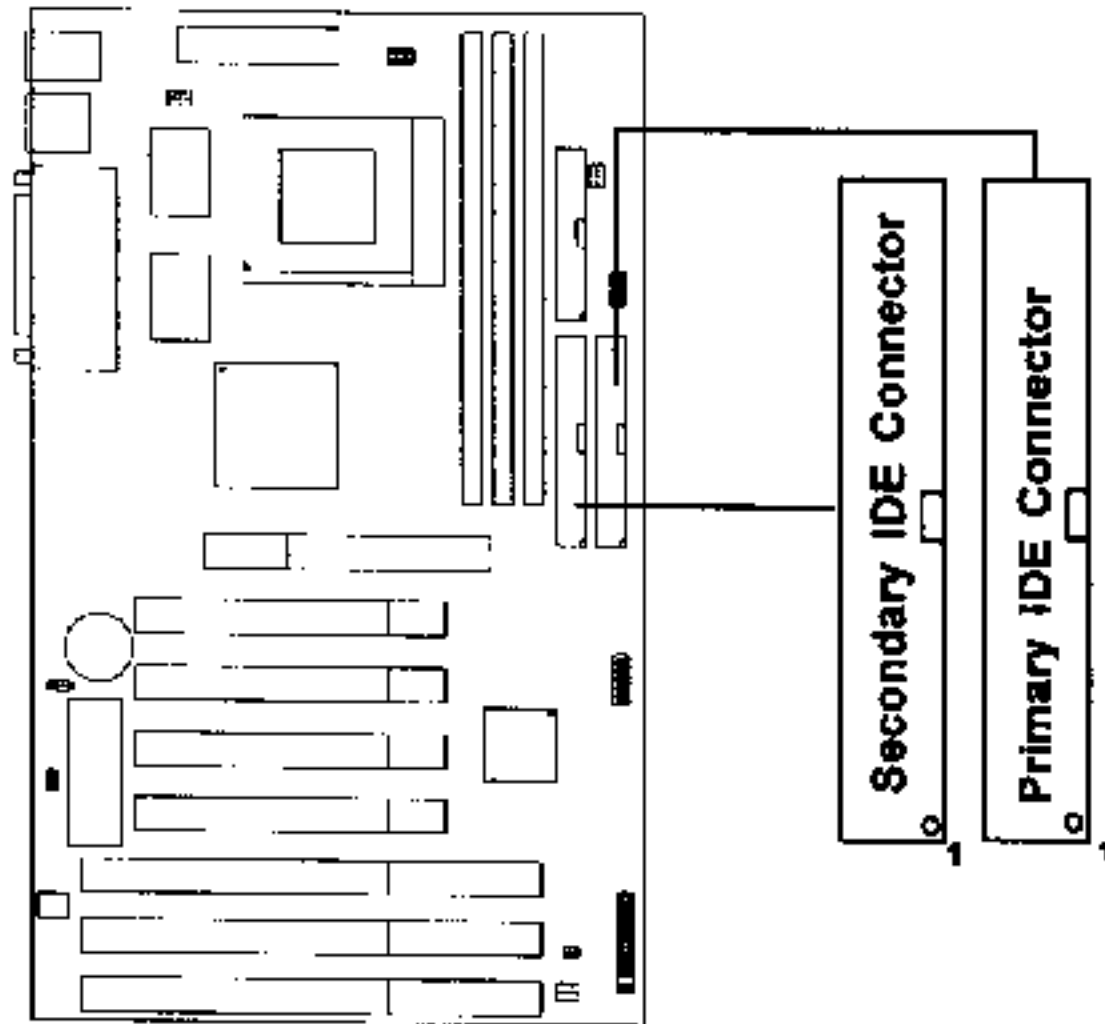

#### IDE1(Primary IDE Connector)

The first hard disk should always be connected to IDE1. IDE1 can connect a Master and a Slave drive.

#### IDE2(Secondary IDE Connector)

IDE2 can connect a Master and a Slave drive.

### 2.6 ATX 20-pin Power Connector: JWR1

This type of connector already supports the remote ON/OFF function. However, you need to connect the Remote Power On/OFF switch (JRMS1).

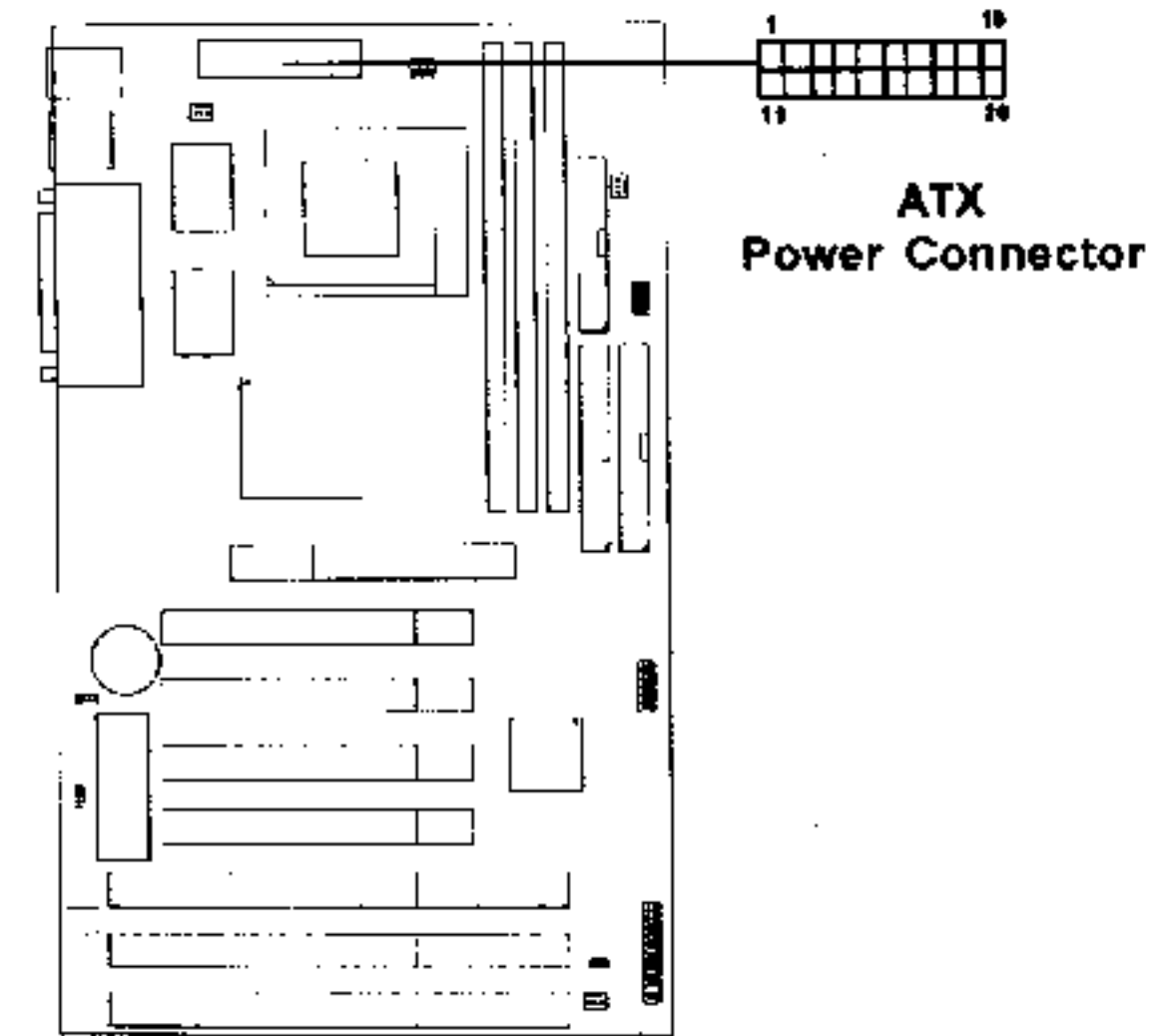

#### ATX Power Connector Pin Description

20	19	18	17	16	15	14	13	12	11
5V	5V	-5V	GND	GND	GND	PS_ON	GND	-12V	3.3V
12V	5V_SB	PW_OK	GND	5V	GND	5V	GND	3.3V	3.3V
10	9	8	7	6	5	4	3	2	1

### 2.7 Remote Power On/Off Switches: JRMS1/ JRMS2 (JP1)

Connect to a 2-pin push button switch to JRMS1/JRMS2. Every time the switch is shorted by pushing it once, the power supply will change its status from OFF to ON. During ON stage: push once and the system goes to sleep mode; push it more than 4 seconds will change its status from ON to OFF.

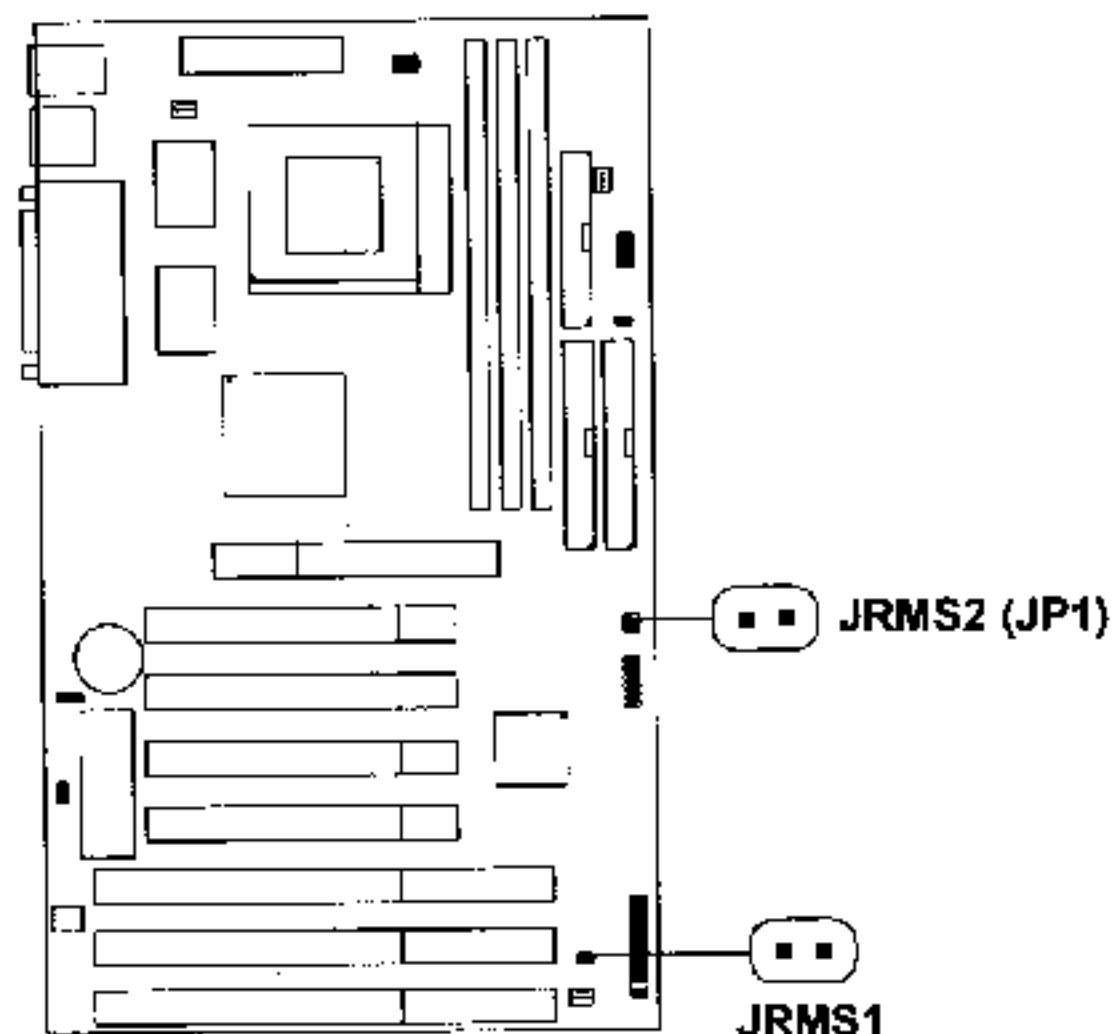

### 2.8 Serial Port Connectors: COM A & COM B

The mainboard has two serial ports COMA and COMB. These two ports are 16550A high speed communication ports that send/receive 16 bytes FIFOs. You can attach a mouse or a modem cable directly into these connectors.

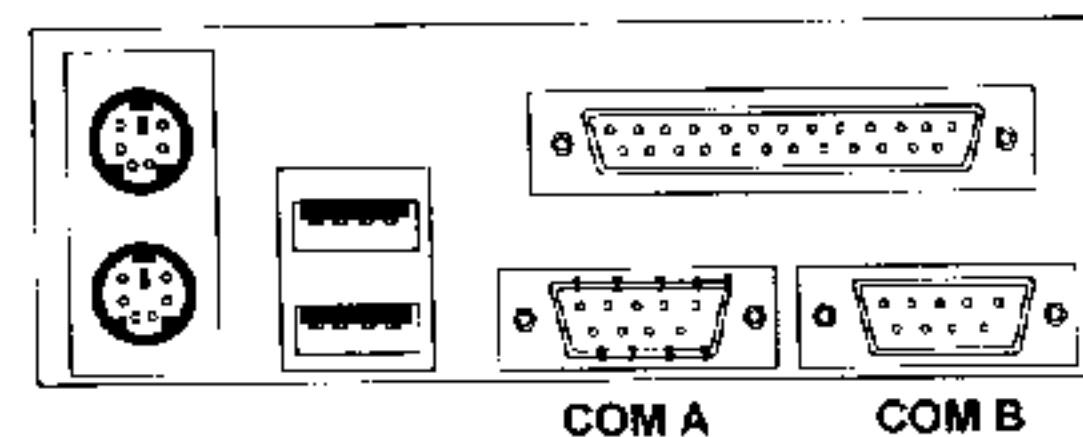

Serial Ports (9-pin Male)

#### PIN DEFINITION

Pin #	Definition
1	DCD(Data Carry Detect)
2	SIN(Serial In or Receive Data)
3	SOUT(Serial Out or Transmit Data)
4	DTR(Data Terminal Ready)
5	GND
6	DSR(Data Set Ready)
7	RTS(Request To Send)
8	CTS(Clear To Send)
9	RI(Ring Indicate)

### 2.9 Parallel Port Connector: LPT

The mainboard provides a connector for LPT. A parallel port is a standard printer port that also supports Enhanced Parallel Port(EPP) and Extended capabilities Parallel Port(ECP).

**Parallel Port (25-pin Female)  
LPT**

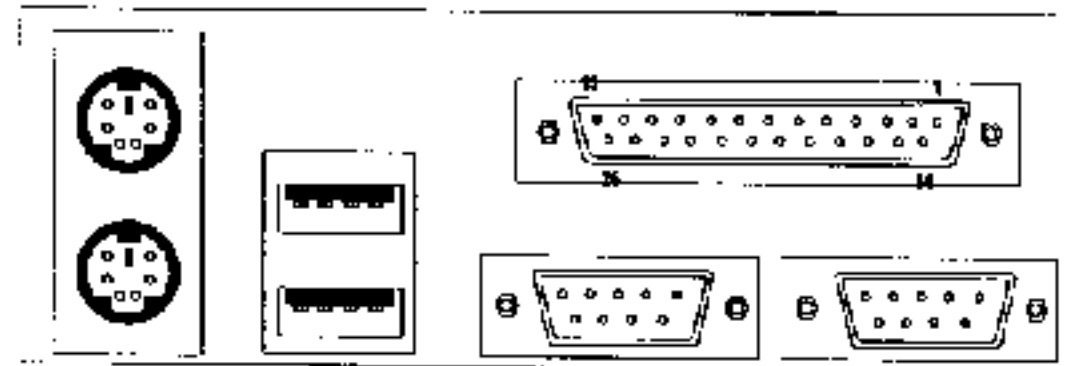

#### PIN DEFINITION

PIN #	DEFINITION	PIN #	DEFINITION
1	STROBE	14	AUTO FEED#
2	DATA0	15	ERR#
3	DATA1	16	INIT#
4	DATA2	17	SLIN#
5	DATA3	18	GND
6	DATA4	19	GND
7	DATA5	20	GND
8	DATA6	21	GND
9	DATA7	22	GND
10	ACK#	23	GND
11	BUSY	24	GND
12	PE	25	GND
13	SELECT		

### 2.10 Keyboard Connector: PSKBC Mouse Connector: PSMSC

The mainboard provides a standard PS/2® keyboard mini DIN connector for attaching a keyboard. You can plug a keyboard cable directly to this connector.

It also provides a standard PS/2® mouse mini DIN connector for attaching a PS/2® mouse. You can plug a PS/2® mouse directly into this connector. The connector location are shown below:

**PS/2® Mouse (6-pin Female)**

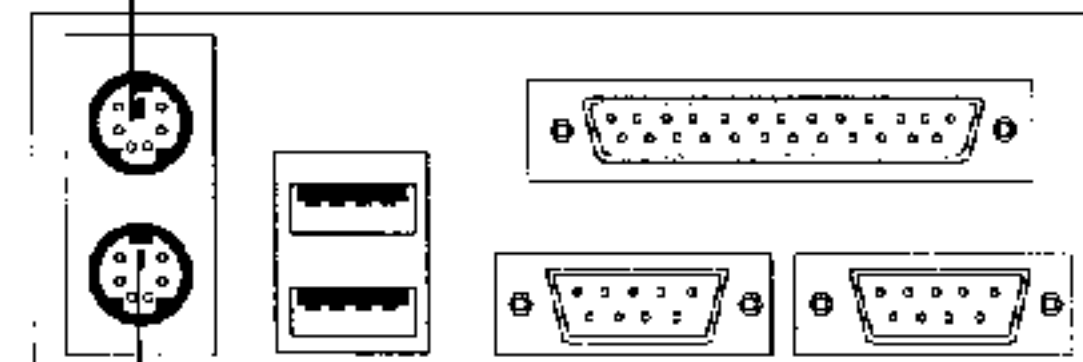

**PS/2® Keyboard (6-pin Female)**

### 2.11 USB Connectors: USB

The mainboard provide a USB(Universal Serial Bus) connector for attaching USB devices like keyboard, mouse or etc. You can plug it directly to this connector.

**USB port 1**

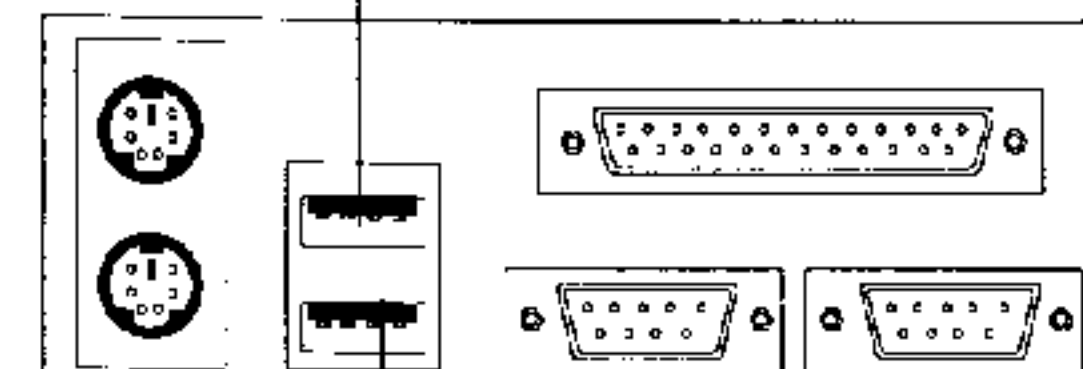

**USB port 2**

### 2.12 External Battery Connector: JP10

A battery must be used to retain the mainboard configuration in CMOS RAM. If you use the on-board battery, you must short 2-3 pins of JP10 to keep the CMOS data.

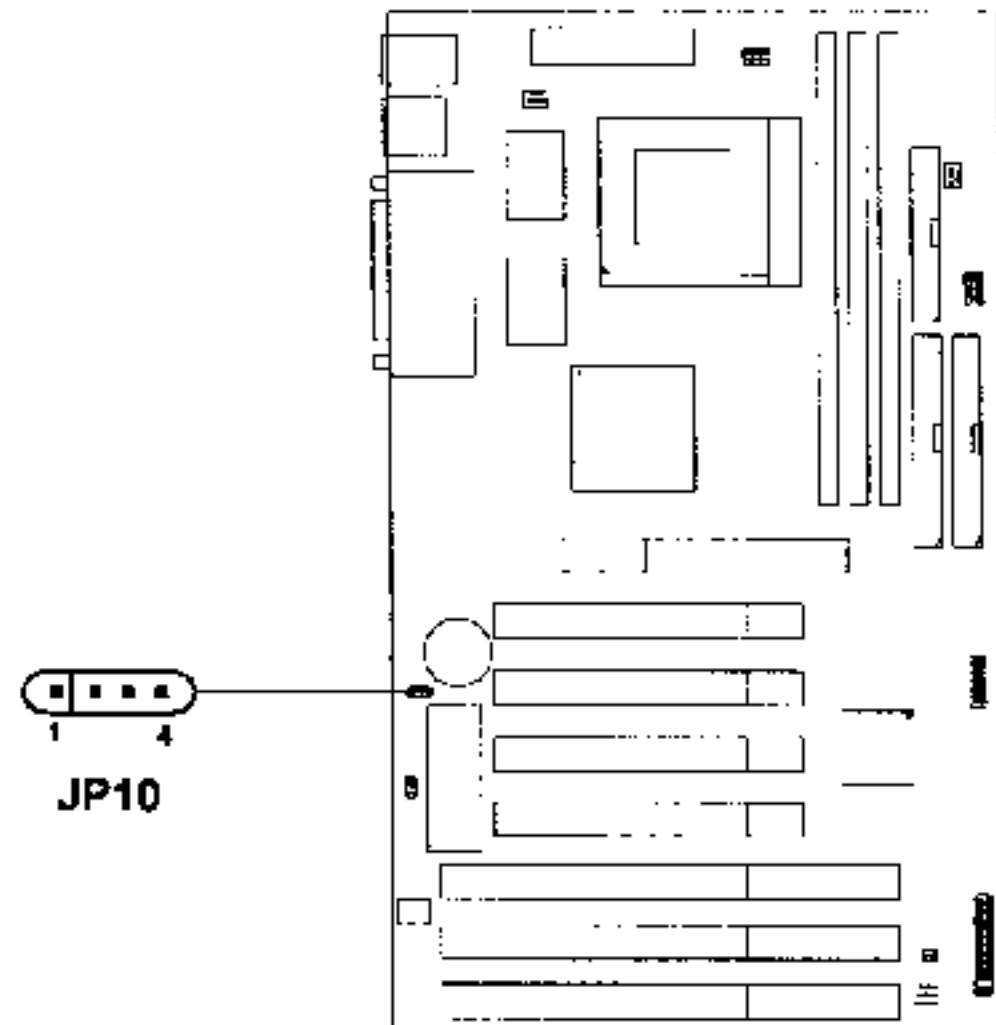

JP10	Function
	Keep Data
	Clear Data (Short for 10 seconds)

**Note:** You can clear CMOS by shorting 3-4 pin for 10 seconds, while the system is off. Then, return to 2-3 pin position. To be able to clear the CMOS, you need to unplug the system since there's always a 3V standby power onboard.

### 2.13 Power On Mode Feature: JP11

The mainboard supports two kinds of system boot up: the Boot-Up by switch and the Immediate Boot-Up. With the Boot-Up by Switch, the system will boot up only when the power on switch is pressed. For Immediate Boot-Up, the system will boot up instantly when the power connector is connected into the system.

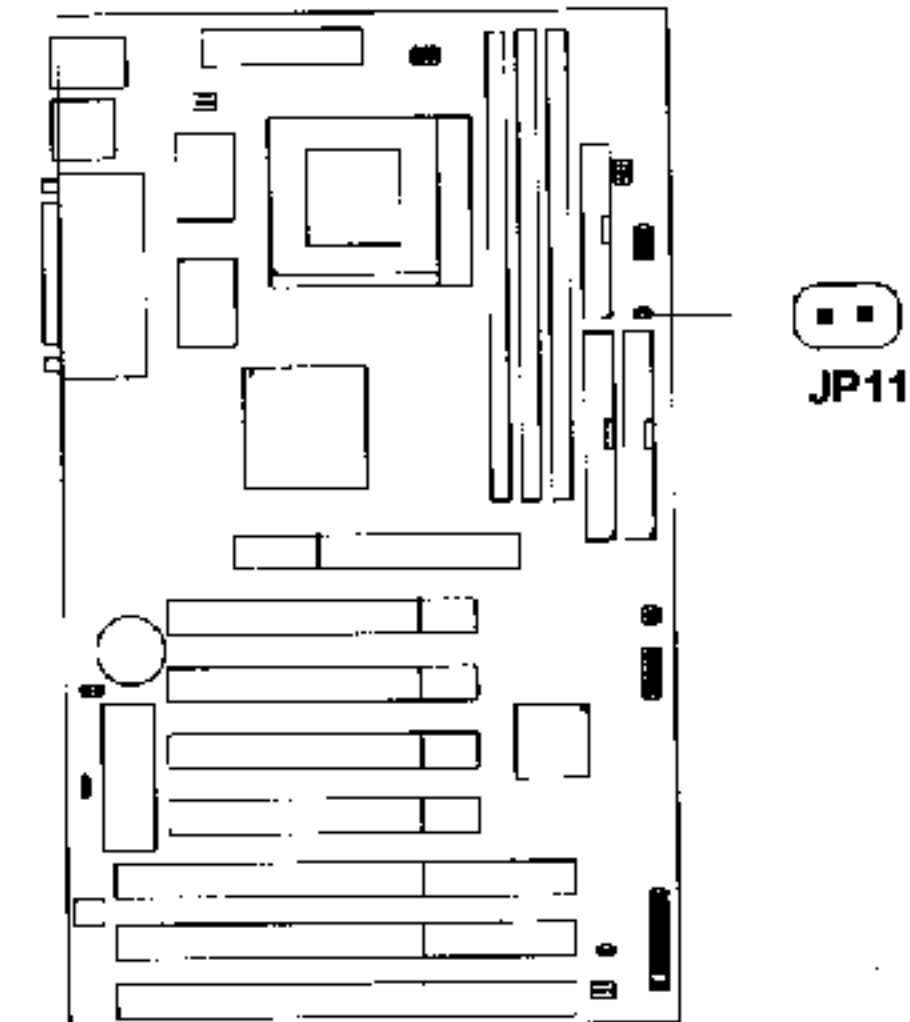

Table 2.13: Power On Mode Feature

JP11	Feature
	Select Boot-Up by Switch
	Select Immediate Boot-Up

**Note:** Short JP11, when using Boot-Up by Switch feature. Open JP11, to enable Immediate Boot-Up.



## 2.14 Green Button and Power Switch: JP1

Attach a power saving switch to JP1(Green Button). When the switch is pressed, the system immediately goes into suspend mode. Press any key and the system wakes up.

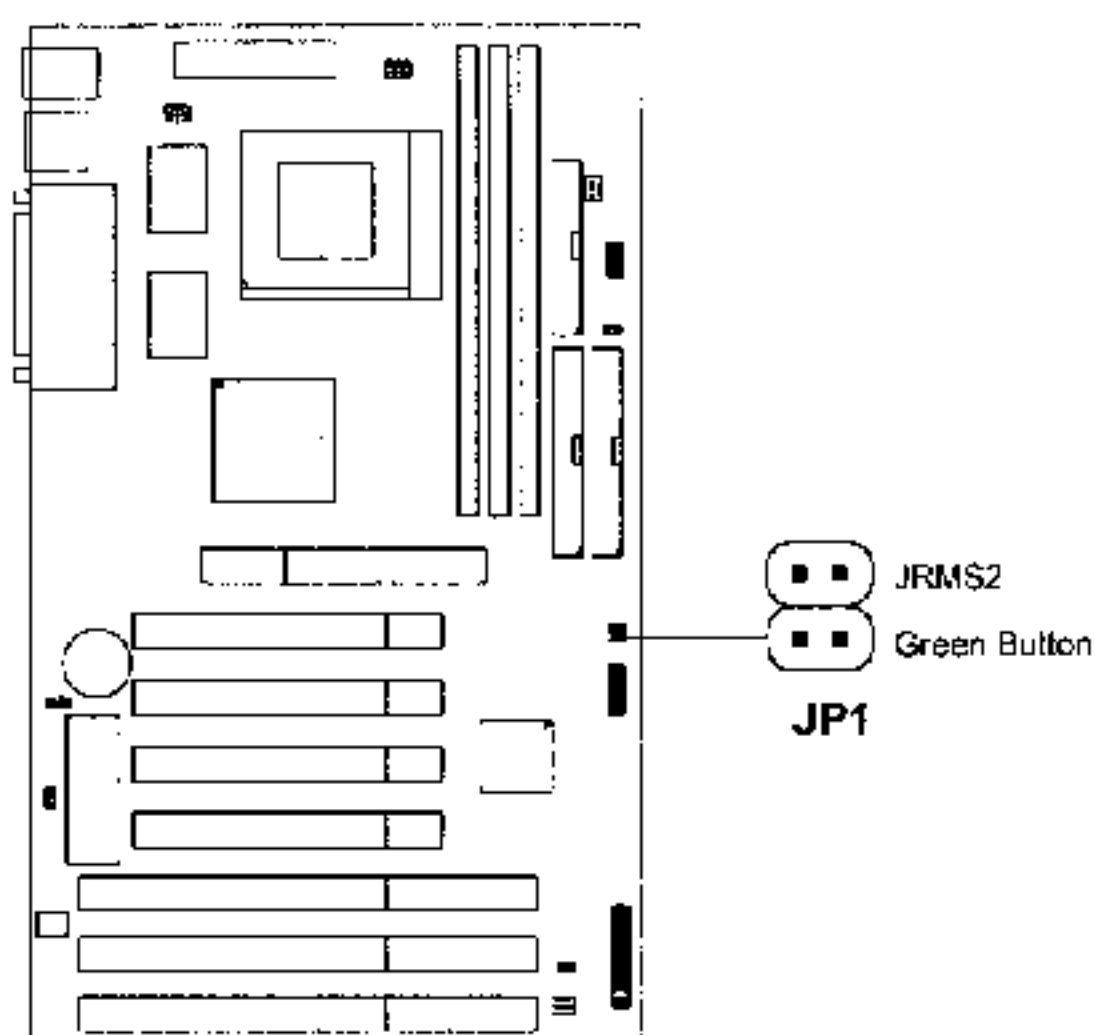

**Note:** The JP1(JRMS2) have the same function with JRMS1. (see **Remote Power On/Off switches: JRMS1/JRMS2**)

## Chapter 3

### AMI® BIOS USER GUIDE

The system configuration information and chipset register information is stored in the CMOS RAM. This information is retained by a battery when the power is off. Enter the BIOS setup (if needed) to modify this information.

The following pages will describe how to enter BIOS setup, and all about options.

### 3.1 Enter BIOS Setup

Enter the AMI® setup Program's Main Menu as follows:

1. Turn on or reboot the system. The following screen appears with a series of diagnostic check.

```
AMIBIOS (C) 1998 American Megatrends Inc.
A5169MS VXXX XXXXXX
Main Processor: XXXXX
Processor Clock: XXXMHz
```

Hit <DEL> if you want to run setup

```
(C) American Megatrends Inc.
61-XXXX-001169-00111111-071592-182440FX-H
```

2. When the "Hit <DEL>" message appears, press <DEL> key to enter the BIOS setup screen.
3. After pressing <DEL> key, the BIOS setup screen will appear.

*Note: If you don't want to modify CMOS original setting, then don't press any key during the system boot.*

```
AMIBIOS HIFLEX SETUP UTILITIES - VERSION 1.20
(C) 1998 American Megatrends, Inc. All Rights
Reserved
```

```
Standard CMOS Setup
Advanced CMOS Setup
Advanced Chipset Setup
Power Management Setup
PCI/Plug and Play Setup
Peripheral Setup
Hardware Monitor Setup
Auto-Detect Hard Disks
Change User Password
Change Supervisor Password
Change Language Setting
Auto Configuration with Optimal Settings
Auto Configuration with Fail Safe Settings
Save Settings and Exit
Exit without Saving
```

Standard CMOS setup for changing time, hard disk type, etc.

4. Use the <Up> and <Down> key to move the highlight scroll up or down.
5. Use the <ENTER> key to select the option.
6. To exit, press <ESC>. To save and exit, press <F10>.
7. Section 3.2 to 3.7 will explain the option in more details.

3.2 Standard CMOS Setup

1. Press <ENTER> on "Standard CMOS Setup" of the main menu screen .

AMIBIOS SETUP - STANDARD CMOS SETUP											
(C) 1998 American Megatrends, Inc. All Rights Reserved											
Date (mm/dd/yyyy):	Fri Feb 27, 1998										
Time (hh/mm/ss):	17:09:25										
Floppy Drive A:	1.44 MB 3 1/2										
Floppy Drive B:	Not Installed										
	Type	Size	Cyln	Head	WPcom	Sec	LBA Mode	Blk Mode	PIC Mode	32Bit Mode	
Pri Master	:Auto									ON	
Pri Slave	:Auto									ON	
Sec Master	:Auto									ON	
Sec Slave	:Auto									ON	
Boot Sector Virus Protection Disabled											
Month	: Jan-Dec					ESC:Exit	:Sel				
Day	: 01-31					PgUp/PgDn:	Modify				
Year	: 1901-2099					F2/F3:	Color				

2. Use <Up> and <Down> to choose the item and <PgUp> and <PgDn> keys to modify the highlighted item.
3. After you have finished with the Standard CMOS Setup, press <ESC> to go back to the main menu.

3.3 Advanced CMOS Setup

1. Press <ENTER> on "Advanced CMOS Setup" of the main menu

AMIBIOS SETUP - ADVANCED CMOS SETUP		
(C) 1998 American Megatrends, Inc. All Rights Reserved		
1st Boot Device	FLOPPY	Available Options:
2nd Boot Device	IDE-0	Disabled
3rd Boot Device	CD-ROM	IDE0
4th Boot Device	Disabled	IDE1
Try Other Boot Devices	Yes	IDE2
Quick Boot	Enabled	IDE3
BootUp Num-Lock	On	Floppy
Floppy Drive Swap	Disabled	ARM0-FDD
Floppy Drive Seek	Disabled	ARM0-HDD
Floppy Access Control	Normal	CDROM
HDD Access Control	Normal	SCSI
PS/2 Mouse Support	Enabled	Network
Primary Display	VGA/EGA	
Password Check	Setup	
Boot to OS/2	No	
External Cache	Enabled	
System BIOS Cacheable	Enabled	
Video BIOS Shadow	Enabled	
C800, 16k Shadow	Disabled	
CC00, 16k Shadow	Disabled	
D000, 16k Shadow	Disabled	
D400, 16k Shadow	Disabled	
D800, 16k Shadow	Disabled	
DC00, 16k Shadow	Disabled	
		ESC:Exit :Sel
		PgUp/PgDn:Modify
		F2/F3:Color

2. Use <Up> and <Down> to choose the item and <PgUp> and <PgDn> keys to modify the highlighted item.
3. After you have finished with the Advanced CMOS Setup, press <ESC> to go back to the main menu.

**Description of the item on screen follows:****1st Boot Device/2nd Boot Device/3rd Boot Device/4th Boot Device**

This option sets the sequence of boot drives.

The settings are:

IDE0	The system will boot from the first HDD.
IDE1	The system will boot from the Second HDD.
IDE2	The system will boot from the Third HDD.
IDE3	The system will boot from the Fourth HDD.
Floppy	The system will boot from Floppy drive.
ARMD-FDD	The system will boot from IO MEGA drive.
ARMD-HDD	The system will boot from LS-120 drive.
SCSI	The system will boot from the SCSI.
Network	The system will boot from the Network drive.
CD-ROM	The system will boot from the CD-ROM.
Disable	Disable this sequence.

**Try other Boot Devices**

This option sets the boot device, if all the Four Boot Devices failed.

**Quick Boot**

Set this option to Enabled to permit AMI® BIOS to boot within 8 seconds. This option replaces the old ABOVE 1 MB Memory Test option. The Optimal default setting is Enabled. The Fail-Safe default setting is Disabled.

**Boot up Num Lock**

When this option is set to Off, AMI® BIOS turns off the Num Lock key when the system is powered on. The end user can then use the arrow keys on both the numeric keypad and the keyboard. The settings are On or Off. The optimal default and Fail-Safe default settings are On.

**Floppy Drive Swap**

Set this option to Enabled to specify that floppy drives A: and B: are swapped. The settings are Enabled and Disabled. The Optimal and Fail-Safe default settings are Disabled.

**Floppy Drive Seek**

When this option is set to Enabled, AMI® BIOS performs a Seek command on floppy drive A: before booting the system. The settings are Enabled and Disabled. The Optimal and Fail-Safe default settings are Disabled.

**Floppy Access Control**

This option sets the Floppy to Read-only or Read-Write.

**HDD Access Control**

This option sets the HDD to Read-only or Read-Write. During Read-only, if you try to write on the HDD, the system will halt.

**PS/2® Mouse Support**

When this option is set to Enabled, AMI® BIOS supports a PS/2® mouse. The settings are Enabled and Disabled. The Optimal and Fail-Safe default settings are Enabled.

**Primary Display**

This option configures the primary display subsystem in the computer. The settings are Mono(monochrome), 40CGA, 80CGA, or VGA/EGA. The Optimal and Fail-Safe default settings are VGA/EGA.

**Password Check**

This option specifies the type of AMI® BIOS password protection that is implemented. The Optimal and Fail-Safe default settings are Setup.



**Boot to OS/2**

Set this option to Enabled to permit the BIOS to run properly, if OS/2® is to be used with > 64MB of DRAM. The settings are Enabled or Disabled. The Optimal and Fail-safe default settings are Disabled.

**External Cache**

This option Enabled or Disabled the External Cache.

**System BIOS Cacheable**

AMI® BIOS always copies the system BIOS from ROM to RAM for faster execution. Set this option to Enabled to permit the contents of the F0000h RAM memory segment to be written to and read from cache memory. The settings are Enabled or Disabled. The Optimal default setting is Enabled.

**Video BIOS Shadow**

Determines whether video BIOS will be copied to RAM for faster execution. Video shadow will increase the video performance.

- Enabled(default) Video shadow is enabled
- Disabled Video shadow is disabled

**C800, 16k Shadow/CC00, 16k Shadow/D000, 16K Shadow/D400, 16k Shadow/D800, 16k Shadow/DC00, 16K Shadow**

These options specify how the contents of the adaptor ROM named in the option title are handled. The ROM area that is not used by ISA adapter cards will be allocated to PCI adapter cards. The settings are;

- Disabled** - The specified ROM is not copied to RAM.
- Cache** - The contents of the ROM area are not only copied from ROM to RAM for faster execution, it can also be written to or read from cache memory.
- Shadow** - The contents of the ROM area are copied from ROM to RAM for faster execution.

The Optimal and Fail-Safe default settings are Disabled.

**3.4 Advanced Chipset Setup**

1. Press <ENTER> on "Advanced Chipset Setup" of the main menu screen.

AMIBIOS SETUP - ADVANCED CHIPSET SETUP		
(C) 1998 American Megatrends, Inc. All Rights Reserved		
USB Function	Disabled	Available Options: Enabled Disabled
USB Keyboard Legacy Support	Disabled	
SDRAM Burst X-1-1-1-1-1-1	Enabled	
DRAM Timing	Normal	
Pipe Function	Enabled	
Gated Clock	Disabled	
Graphics Aperture Size	64	
Primary Frame Buffer	Enabled	
VGA Frame Buffer	Enabled	
Data Merge	Disabled	
Passive Release	Enabled	
ISA Line Buffer	Enabled	
Delay Transaction	Disabled	
AT Bus Clock	Auto	
		ESC:Exit :Sel PgUp/PgDn:Modify F2/F3:Color

2. Use <Up> and <Down> to choose the item and <PgUp> and <PgDn> keys to modify the highlighted item.
3. After you have finished with the Advanced Chipset Setup, press <ESC> to go back to the main menu.

**Description of the item on screen follows:****USB Function**

Set this option to Enable or Disable the on-chip USB controller. The Optional and Fail-Safe default settings are Disabled.

**USB Keyboard Legacy Support**

Set this option to Enable or Disable USB keyboard/mouse. The Optional and Fail-Safe default settings are Disabled.

**SDRAM Burst X-1-1-1-1-1-1**

During Enabled, this will improve the SDRAM module burst function. Some SDRAM module doesn't support this function, so this must be set to Disabled.

**DRAM Timing**

Choose DRAM timing for customize setup.

**Pipe Function**

Set this option to Enable the pipeline from the PCI bus to system memory. The settings are Enabled or Disabled. The Optimal and Fail-Safe Default settings are Enabled.

**Gated Clock**

Set to Enable, if there's no PCI Interface cycle. The PCI Interface will be automatically shutdown.

**Graphics Aperture Size**

This option determines the effective size of the graphics aperture used in the particular PAC configuration. The AGP aperture is memory-mapped, while graphics data structure can reside in a graphics aperture. The aperture range should be programmed as not cacheable in the processor cache, accesses with the aperture range are forwarded to the main memory, then PAC will translate the original issued address via a translation table that is maintained on the main memory. The option allows the selection of an aperture size of 4MB, 8MB, 16MB, 32MB, 64MB, 128MB, and 256MB.

**Primary Frame Buffer**

The processor provides a write-combining with buffering strategy for write operation. This is useful for frame buffering. Writing to USWC memory can be buffered and combined in the processor's write-combining buffer (WCB). The WCBs are viewed as a special purpose outgoing write buffers, rather than a cache. The WCBs are written into memory to allocate a different address, or after executing a serializing, locked, or I/O instructions.

During Enabled, this will enable the processor memory location C000 and DFFF segment as USWC memory type.

**VGA Frame Buffer**

The processor provides a write-combining with buffering strategy for write operation. This is useful for frame buffering. Writing to USWC memory can be buffered and combined in the processors write-combining buffer (WCB). The WCBs are viewed as a special purpose outgoing write buffers, rather than a cache. The WCBs are written into memory to allocate a different address, or after executing a serializing, locked, or I/O instructions.

During Enabled, this will enable the processor memory location A000 and B000 segment as USWC memory type.

**Data Merge**

During Enabled, this will use Burst Cycle for Data Transfer.

**Passive Release**

During Enabled, this will allow the chipset to use passive release while transferring control information or data for transaction. During Disabled, chipset will perform PCI accesses without using passive release.

**ISA Line Buffer**

When an ISA/DMA master reads from the PCI memory, the M1543 chipset prefetches 8 bytes of data into the line buffer. Default settings is Enabled.

**Delay Transaction**

During Enabled, the chipset delay transaction mechanism is enabled when the chipset is the target of a PCI transaction. A read cycle from Host to PCI is immediately retrieved due to any pending PCI to DRAM cycle. During Disabled, a read cycle from Host to PCI is waited until time-out due to any pending PCI to DRAM cycle.

**AT Bus Clock**

This is used to set the ISA Bus Clock Frequencies.

**3.5 Power Management Setup**

1. Press <ENTER> on "Power Management Setup" of the main menu screen.

AMIBIOS SETUP - POWER MANAGEMENT SETUP		
(C) 1998 American Megatrends, Inc. All Rights Reserved		
Power Management / APM	Enabled	Available Options: Enabled Disabled
Green Monitor Power State	Off	
Video Power Down Mode	Suspend	
Hard Disk Power Down Mode	Disabled	
Standby Time Out	Disabled	
Suspend Time Out	Disabled	
*System Event Monitor by Timer		
Monitor Parallel Port	Yes	ESC:Exit :Sel PgUp/PgDn:Modify F2/F3:Color
Monitor Serial Port	Yes	
Monitor Floppy	Yes	
Monitor VGA	No	
Monitor Audio	No	
Monitor Pri-HDD	Yes	
Monitor Sec-HDD	No	
Power Button Function	Soft Off	
Ring Resume From Soft-Off	Disabled	
RTC Alarm Resume	Disabled	
RTC Alarm Date	15	
RTC Alarm Hour	12	
RTC Alarm Minute	50	
RTC Alarm Second	30	

2. Use <Up> and <Down> to choose the item and <PgUp> and <PgDn> keys to modify the highlighted item.
3. After you have finished with the Power Management Setup, press <ESC> to go back to the main menu.

**Description of the item on screen follows:****Power Management/APM**

Set this option to Enabled to enable the power management features and APM(Advanced Power Management). The settings are Enabled, Inst-On(instant-on) or Disabled. The Optimal and Fail-Safe default settings are Disabled.

**Green Monitor Power State**

This option specifies the power state that the green PC-compliant video monitor enters when AMI® BIOS places it in a power savings state after the specified period of display inactivity has expired. The settings are Off, Standby, Suspend or Disabled. The Optimal and Fail-Safe default settings are Standby.

**Video Power Down Mode**

This option specifies the power conserving state that the VESA VGA video subsystem enters after the specified period of display inactivity has expired. The settings are Disabled, Standby or Suspend. The Optimal and Fail-Safe default settings are Standby.

**Hard Disk Power Down Mode**

This option specifies the power conserving state that the hard disk drive enters after the specified period of hard drive inactivity has expired. The settings are Disabled, Standby or Suspend. The Optimal and Fail-Safe default settings are Disabled.

**Standby Time Out**

This option specifies the length of a period of system inactivity while in Full power on state. When this length of time expires, the computer enters Standby power state. The settings are Disabled, 1 min, 2 min, 3 min, 4 min, 5 min, 6 min, 7 min, 8 min, 9 min, 10 min, 11 min, 12 min, 13 min, 14 min or 15 min. The Optimal and Fail-Safe default settings are Disabled.

**Suspend Time Out**

This option specifies the length of a period of system inactivity while in Standby state. When this length of time expires, the computer enters Suspend power state. The settings are Disabled, 1 min, 2 min, 3 min, 4 min, 5 min, 6 min, 7 min, 8 min, 9 min, 10 min, 11 min, 12 min, 13 min, 14 min or 15 min. The Optimal and Fail-Safe default settings are Disabled.

**Monitor Parallel Port/Monitor Serial Port/Monitor Floppy/  
Monitor VGA/Monitor Audio/Monitor Pri-HDD/Monitor Sec-  
HDD**

When set to Yes, these options enable event monitoring on the specified hardware interrupt request line. If set to Yes and the computer is in a power saving state, AMI® BIOS watches for activity on the specified IRQ line. The computer enters the full on power state if any activity occurs.

AMI® BIOS reloads the Standby and Suspend timeout timers if activity occurs on the specified IRQ line.

**Power Button Function**

During Suspend, if you push the switch one time, the system goes into suspend mode and if you push it more than 4 seconds, the system will be turned off. During On/Off, the system will turn off once you push the switch.

**Ring Resume from Soft-Off**

During Disabled, the system will ignore any incoming call from the modem. During Enabled, the system will boot up if there's an incoming call from the modem.

**Note:** If you have change the setting, you must let the system boot up until it goes to the operating system. Then, power off the system. This function will work the next time you power on.

**RTC Alarm Resume**

This function is for setting the Date, Hour, Minute, and Second for your computer to boot up. During Disabled, you cannot use this function. During Enabled, Choose the Date, Hour, Minute, and Second:

- RTC Alarm Date** Choose which day the system will boot up.
- RTC Alarm Hour** Choose which hour the system will boot up.
- RTC Alarm Minute** Choose which minute the system will boot up.
- RTC Alarm Second** Choose which second the system will boot up.

**Note:** If you have change the setting, you must let the system boot up until it goes to the operating system. Then, power off the system. This function will work the next time you power on.

**3.6 PCI/Plug and Play Setup**

1. Press <ENTER> on "PCI/Plug and Play Setup" of the main menu screen.

AMIBIOS SETUP - PCI/PLUG AND PLAY SETUP		
(C) 1998 American Megatrends, Inc. All Rights Reserved		
Plug and Play Aware O/S	No	Available Options: Enabled Disabled
Clear NVRAM on Every Boot	No	
PCI Latency Timer (PCI Clocks)	32	
PCI VGA Palette Snoop	Disabled	
OffBoard PCI IDE Card	Auto	
OffBoard PCI IDE Primary IRQ	Disabled	
OffBoard PCI IDE Secondary IRQ	Disabled	
Assign IRQ to PCI VGA	Yes	
PCI Slot1 IRQ Priority	Auto	
PCI Slot2 IRQ Priority	Auto	
PCI Slot3 IRQ Priority	Auto	
PCI Slot4 IRQ Priority	Auto	
DMA Channel 0	PnP	
DMA Channel 1	PnP	
DMA Channel 3	PnP	
DMA Channel 5	PnP	
DMA Channel 6	PnP	
DMA Channel 7	PnP	
IRQ3	PCI/PnP	ESC:Exit :Sel PgUp/PgDn:Modify F2/F3:Color
IRQ4	PCI/PnP	
IRQ5	PCI/PnP	
IRQ7	PCI/PnP	
IRQ8	PCI/PnP	
IRQ9	PCI/PnP	
IRQ10	PCI/PnP	
IRQ11	PCI/PnP	
IRQ12	PCI/PnP	
IRQ14	PCI/PnP	
IRQ15	PCI/PnP	

2. Use <Up> and <Down> to choose the item and <PgUp> and <PgDn> keys to modify the highlighted item.
3. After you have finished with the PCI/Plug and Play Setup, press <ESC> to go back to the main menu.



**Description of the item on screen follows:****Plug and Play Aware O/S**

Set this option to Yes if the operating system in this computer is aware of and follows the Plug and Play specification. Currently, only Windows 95® is PnP-aware. The settings are Yes or No. The Optimal and Fail-Safe default settings No.

**Clear NVRAM on Every Boot**

During Enabled, this option will reset the NVRAM on every boot.

**PCI Latency Timer (PCI Clocks)**

This option specifies the latency timings (in PCI clocks) for all PCI devices on the PCI bus. The settings are 32, 64, 96, 128, 160, 192, 224 or 248. The Optimal and Fail-Safe default settings are 64.

**PCI VGA Palette Snoop**

When this option is set to Enabled, multiple VGA devices operating on different buses can handle data from the CPU on each set of palette registers on every video device. Bit 5 of the command register in the PCI device configuration space is the VGA Palette Snoop bit (0 is disabled). For example, if there are two VGA devices in the computer (one PCI and ISA) and the Bit settings are:

**Disabled** - Data read and written by the CPU is only directed to the PCI VGA device's palette registers.

**Enabled** - Data read and written by the CPU is directed to both the PCI VGA device's palette registers and the ISA VGA device palette registers, permitting the palette registers of both devices to be identical.

This option must be set to Enabled if an ISA adapter card requires VGA palette snooping. The settings are Enabled or Disabled. The Optimal and Fail-Safe default settings are Disabled.

**Offboard PCI IDE Card**

This option specifies if an offboard PCI IDE controller adapter card is installed in the computer. You must specify the PCI expansion slot on the mainboard where the offboard PCI IDE controller is installed. If an offboard PCI IDE controller is used, the onboard IDE controller is automatically disabled. The settings are Auto(AMI® BIOS automatically determines where the offboard PCI IDE controller adapter card is installed), Slot1, Slot2, Slot3 or Slot4. The Optimal and Fail-Safe settings are Auto.

If an offboard PCI IDE controller adapter card is installed in the computer, you must also set the Offboard PCI IDE Primary IRQ and Offboard PCI IDE Secondary IRQ options.

**Offboard PCI IDE Primary IRQ/  
Offboard PCI IDE Secondary IRQ**

These options specify the PCI interrupt used by the Primary (or Secondary) IDE channel on the offboard PCI IDE controller. The settings are Disabled, Hardwired, INTA, INTB, INTC or INTD. The Optimal and Fail-Safe default settings are Disabled.

**Assign IRQ to PCI VGA**

Choose the IRQ to be assigned to the PCI VGA display adapter card. The Optimal and Fail-Safe default setting is No.

**PCI Slot1 IRQ Priority/PCI Slot2 IRQ Priority/PCI Slot3 IRQ  
Priority/PCI Slot4 IRQ Priority**

These options specify the priority IRQ to be used for any PCI devices installed in the PCI expansion slots 1 through 4. The settings are Auto(AMI® BIOS automatically determines the priority IRQ), (IRQ) 3, 4, 5, 7, 9, 10, or 11. The Optimal and Fail-Safe default settings are Auto.

**DMA Channel 0/1/3/5/6/7**

These options specify the bus that the specified DMA channel is used. These options allow you to reserve DMAs for legacy ISA adapter cards.

These options determine if AMI® BIOS should remove a DMA from the available DMAs passed to devices that are configurable by the system BIOS. The available DMA pool is determined by reading the ESCD NVRAM. If more DMAs must be removed from the pool, the end user can use these options to reserve the DMA by assigning an ISA/EISA setting to it.

**IRQ3/IRQ4/IRQ5/RQ7/IRQ9/IRQ10/IRQ11/IRQ14/IRQ15**

These options specify the bus that the specified IRQ line is used on. These options allow you to reserve IRQs for legacy ISA adapter cards.

These options determine if AMI® BIOS should remove an IRQ from the pool of available IRQs passed to devices that are configurable by the system BIOS. The available IRQ pool is determined by reading the ESCD NVRAM. If more IRQs must be removed from the pool, the end user can use these options to reserve the IRQ by assigning an ISA/EISA setting to it. Onboard I/O is configured by AMI® BIOS. All IRQs used by onboard I/O are configured as PCI/PnP. If all IRQs are set to ISA/EISA and IRQ14 and 15 are allocated to the onboard PCI IDE, IRQ9 will still be available for PCI and PnP devices, because at least one IRQ must be available for PCI and PnP devices. The settings are ISA/EISA or PCI/PnP. The Optimal and Fail-Safe default settings are IRQ3 through 7 are ISA/EISA. The Optimal and Fail-Safe default settings PCI/PnP.

**3.7 Peripheral Setup**

1. Press <ENTER> on "Peripheral Setup" of the main menu screen.

AMIBIOS SETUP - PERIPHERAL SETUP		
(C) 1998 American Megatrends, Inc. All Rights Reserved		
OnBoard FDC	Auto	Available Options: Enabled Disabled
OnBoard Serial Port1	3F8H	
Serial Port1 IRQ	4	
OnBoard Serial Port2	2F8H	
Serial Port Mode	Normal	
Serial Port2 IRQ	3	
IR Transmitter Polarity	N/A	
IR Receiver Polarity	N/A	
IR Half-Duplex Time-Out	N/A	
OnBoard Parallel Port	Auto	
Parallel Port Mode	EPP	
EPP Version	N/A	
Parallel Port IRQ	7	
Parallel Port DMA Channel	N/A	
Onboard IDE	Both	

2. Use <up> and <down> to choose the item and <PgUp> and <PgDn> keys to modify the highlighted item.
3. After you have finished with the Peripheral Setup, press <ESC> to go back to the main menu.

**Description of the item on screen follows:**

**Onboard FDC**

Choose Auto, for the BIOS to automatically detect the device

If the ISA add-on card has	Onboard FDC to be set at
FDC exist	Disabled
none FDC exist	Enabled

Choose Enabled, Enabling onboard FDC.

Choose Disabled, Disabling onboard FDC.

The Optimal and Fail-Safe default settings are Auto.

**Onboard Serial Port 1/Onboard Serial Port 2**

Choose 3F8H, for the BIOS to automatically detect the device.

If the ISA add-on card has				Onboard Serial port to be set at			
COM1 (I/O:3F8H)	COM2 (I/O:3F8H)	COM3 (I/O:3E8H)	COM4 (I/O:2E8H)	PORT1	IRQ ASSIGNED	PORT2	IRQ ASSIGNED
✓	✓	✓	✓	DISABLED	X	DISABLED	X
✓	✓	X	X	COM3	4	COM4	3
X	X	✓	✓	COM1	4	COM2	3
✓	X	X	✓	COM2	3	COM3	4
X	✓	✓	X	COM1	4	COM4	3
✓	✓	✓	X	COM4	3	DISABLED	X
✓	✓	X	✓	COM3	4	DISABLED	X
✓	X	✓	✓	COM2	3	DISABLED	X
X	✓	✓	✓	COM1	4	DISABLED	X
X	X	X	X	COM1	4	COM2	3
✓	X	X	X	COM2	3	COM3	4
X	✓	X	X	COM1	4	COM3	4
X	X	✓	X	COM1	4	COM2	3
X	X	X	✓	COM1	4	COM2	3

**Note:** If the onboard serial port interrupts and ISA add-on card interrupts are in conflict, the serial port will not work properly. Please disable one of the devices.

**Onboard Parallel Port**

Choose Auto, for the BIOS to automatically assign the onboard parallel port to the available parallel port or disabled.

If the ISA add-on card has			Onboard parallel port to be set as	
LPT1 I/O:378H	LPT2 I/O:278H	LPT3 I/O:3BCH	PORT ASSIGNED	IRQ ASSIGNED
✓	✓	✓	Disabled	X
✓	✓	X	LPT3	5
✓	X	✓	LPT2	5
X	✓	✓	LPT1	7
✓	X	X	LPT2	5
X	✓	X	LPT1	7
X	X	✓	LPT1	7
X	X	X	LPT1	7

**Note:** If the onboard parallel port interrupts and ISA add-on card interrupts are in conflict, the parallel port will not work properly. Please disable one of the devices.

**EPP Version**

This option is for setting which EPP version will be used. The settings are 1.7 and 1.9.

**Parallel Port Mode**

This option allows user to choose the operating mode of the onboard parallel port. The settings are Normal, SPP/EPP or ECP mode.

### Parallel Port IRQ

If the onboard parallel mode is not on auto mode, the user can select the interrupt line for onboard parallel port. We suggest that the user select the interrupt for the onboard parallel port as shown below:

Onboard parallel port set at	Parallel Port IRQ
LPT1(378H)	7
LPT2(278H)	5
LPT3(3BCH)	5

### Parallel Port DMA Channel

This option allows user to choose DMA channel 1 to 3 for the onboard parallel port on ECP mode.

### Onboard IDE

Set this option to enable or disable on board IDE controller.

## Chapter 4

### COMPATIBILITY TEST PROBLEM

1. **MEMORY MODULE:** This is a list of the memory modules tested.

#### PC66 DIMM:

MANUFACTURER	MODEL NUMBER	TYPE	SIZE	RESULT
VANGUARD(MS 6930)	VG26V17805BJ6	EDO	16MB	OK
TOSHIBA	TC51V17805BNTS-80	EDO	16MB	OK
VANGUARD	VG26V17405CJ6	EDO	32MB	OK
HYUNDAI	HYM5V64804FG	EDO	64MB	OK
SEC	KM44V4104BS-L6	EDO	64MB	OK
FUJITSU	81117822A-100	SDRAM	16MB	OK
LG	GM72V16821BT10K	SDRAM	16MB	OK
LG	GM72V16821BT10K	SDRAM	16MB	OK
SEC	KM416S1120AT-G10(2*8)	SDRAM	16MB	OK
SEC	KM48S2020AT-G10	SDRAM	16MB	OK
HITACHI	HM5216805TT10	SDRAM	32MB	OK
LG	GM72V16821BT10K	SDRAM	32MB	OK
NEC JATON	D4516821AG5-A10-7JF	SDRAM	32MB	OK
SEC (MS5927)	KM48S2020AT-G10 (ECC)	SDRAM	32MB	OK
mitsubishi (MS 5932)	M5M4V64S40ATP-10	SDRAM	32MB	OK
MITSUBISHI RAMSTAR	M5M4V16S30BTP	SDRAM	32MB	OK
FUJITSU JATON	81117822E-100FN	SDRAM	32MB	OK
FUJITSU	81117822E-100FN	SDRAM	32MB	OK
MICRON	MT46LC2M8A1TG-10	SDRAM	32MB	OK
HYUNDAI	HYM7072A801-TFG	SDRAM	64MB	OK
MITSUBISHI (MS 5932)	M5M4V64S40APT-10	SDRAM	64MB	OK
MITSUBISHI (MS 5928)	M5M4V64S30ATP-10 (ECC)	SDRAM	128MB	OK

**PC100 DIMM:**

MANUFACTURER	MODEL NUMBER	TYPE	SIZE	RESULT
HYUNDAI	HY57V168010CTC-10	SDRAM	16MB	OK
NEC ARMAS	D4516821AG5-A10-7JF	SDRAM	16MB	OK
TI	TMS424812BDGE5H-8 (ECC)	SDRAM	32MB	OK
HYUNDAI	HY57V168010CTC-10	SDRAM	32MB	OK
SEC	KM48S2020CT-G10 (ECC)	SDRAM	32MB	OK
SEC BUFFALO	KM48S2020CT-GH (ECC)	SDRAM	32MB	OK
MICRON	MT48LC2M8AITG-8 (ECC)	SDRAM	32MB	OK
MITSUBISHI	M5M4V16S30DTP (ECC)	SDRAM	32MB	OK
NEC ARMAS	D45168S1AG5-A10-7JF	SDRAM	32MB	OK
NEC BUFFALO	D4516821AG5-A10-7JF	SDRAM	32MB	OK
FUJITSU BUFFALO	81F16822D-102LFN (ECC)	SDRAM	32MB	OK
SEC BUFFALO	KM48S8030BT-GH (ECC)	SDRAM	64MB	OK
NEC BUFFALO	D456841G5-A10-9JF (ECC)	SDRAM	64MB	OK
FUJITSU BUFFALO	81F64842B-103FN (ECC)	SDRAM	64MB	OK
MITSUBISHI BUFFALO	M5M4V64S30ATP (ECC)	SDRAM	64MB	OK

**Incompatible DIMM:**

Manufacturer	Model Number	Type	Size	Result
Hyundai	HY57V658020ATC-10	SDRAM	64MB	Fail
Toshiba	TC59S1608AFT-10	SDRAM	32MB	Fail
Toshiba	TC59S1608AFT-10	SDRAM	16MB	Fail

2. **USB KEYBOARD:** There are some USB keyboard which might not work properly.

The following USB keyboard have some compatibility problem:

1. Qtronix USB keyboard
2. Cherry USB keyboard
3. BTC USB keyboard

3. **AGP VGA Card:**

The following AGP VGA Card have some compatibility problem:

1. MSI MS-4415 Cirrus AGP VGA card (3D Winbench Fail)

**Note:** Please contact your vendors regularly for updates.