

**AI5TT**  
**Pentium Baby AT Motherboard**  
**User's Manual**  
Version 2.0



# Contents

<b>Chapter 1 Introduction.....</b>	<b>1</b>
<b>Chapter 2 Specifications .....</b>	<b>2</b>
<b>Chapter 3 Hardware Description .....</b>	<b>4</b>
3.1 Processor and CPU Voltage .....	6
3.2 L2 Cache Memory .....	6
3.3 Main Memory.....	6
3.4 BIOS.....	8
3.5 Interrupt Request Lines (IRQ).....	8
3.6 DMA Channels.....	9
3.7 I/O Port Address Map.....	9
3.8 Onboard PCI EIDE.....	10
3.9 Onboard Multi-I/O .....	10
3.10 System Hardware Monitor Device (optional).....	10
<b>Chapter 4 Configuring the AI5TT.....</b>	<b>11</b>
4.1 SW1 (1-4), JP3, JP1: CPU Frequency Selector.....	13
4.2 SW2 (1-4): CPU Voltage Selector .....	16
4.3 JP5: Clear CMOS Content.....	18
<b>Chapter 5 Installation .....</b>	<b>19</b>
5.1 J1, J4: AT Keyboard and PS/2 Mouse Connectors.....	21
5.2 J2: ATX Power Supply Connector .....	21
5.3 J3: AT Power Connector .....	22
5.4 J5: Infrared Connector .....	22
5.5 J7, J6: Serial Ports .....	23
5.6 J8: Parallel Port Connector.....	23
5.7 J9: Floppy Drive Connector .....	24
5.8 J10: USB Connector.....	24
5.9 J11: Wake on LAN Connector .....	25
5.10 J12: CPU Fan Power Connector.....	25
5.11 J14, J13: IDE Connectors.....	26
5.12 J15: Front Bezel Connector.....	27

<b>Chapter 6 BIOS Configuration.....</b>	<b>29</b>
6.1 BIOS Introduction .....	32
6.2 BIOS Setup .....	32
6.3 Standard CMOS Setup.....	33
6.4 BIOS Features Setup.....	37
6.5 Chipset Features Setup.....	40
6.6 Power Management Setup .....	42
6.7 PNP/PCI Configuration .....	45
6.8 Load BIOS Defaults .....	47
6.9 Load Setup Defaults.....	47
6.10 Integrated Peripherals .....	48
6.11 Supervisor / User Password .....	50
6.12 IDE HDD Auto Detection.....	51
6.13 HDD Low Level Format.....	51
6.14 Save & Exit Setup.....	52
6.15 Exit Without Saving.....	52
<b>Chapter 7 LANdesk User's Guide .....</b>	<b>53</b>
7.1 Introduction .....	54
7.2 Installation .....	55

## Chapter 1 Introduction

This manual is designed to give you information on the AI5TT Motherboard. It is divided into the following seven sections:

- **Introduction**
- **Specifications**
- **Hardware Description**
- **Configuring the AI5TT**
- **Installation**
- **BIOS Configuration**
- **LANDesk User's Guide**

### Checklist

Please check that your package is complete and contains the items below. If you discover damaged or missing items, please contact your dealer.

- **The AI5TT Motherboard**
- **This User's Manual**
- **1 IDE Ribbon Cable**
- **1 Floppy Ribbon Cable**
- **2 Serial Ribbon Cables\***
- **1 Parallel Ribbon Cable**
- **1 CD containing Intel LANDesk software, PIIX4 Bus Master IDE driver and utilities. *Your package comes with the CD containing Intel's LANDesk software or System Monitor utility if your motherboard supports the onboard hardware monitoring IC.***

\* Use the two serial cables provided to avoid compatibility problems.

## Chapter 2 Specifications

The AI5TT is a high-performance, Pentium PCI motherboard with a Baby AT form factor. It is highly flexible in CPU frequency, L2 cache type and size, and main memory type and size. The AI5TT allows easy access to main memory sockets and expansion by using full length add-in cards. Configured with an ATX power supply, the board supports modem ring-on that allows powering on from remote via an external modem connected to COM1 or COM2.

The main features are listed as follows:

### Main Processor

Intel Pentium/Pentium MMX\* 90/100/120/133/150/166/200/233  
Cyrix 6x86/6x86L/6x86MX P150+/P166+/PR200/PR233  
AMD K5 PR100/PR133/PR166  
AMD K6/166/200/233/266/300  
\*Pentium MMX = P55C

### Processor Upgrade

Intel P6 based Over Drive

### L2 Cache

**Size:** 512K  
**Type:** Pipeline Burst Synchronous SRAM onboard

### Main Memory

Up to 256MB of main memory

### Memory Type

**SIMMs:** FPM (Fast Page Mode) or EDO (Extended Data Out)  
**SIMM Size:** 4MB, 8MB, 16MB, 32MB, 64MB  
**DIMMs:** SDRAM (Synchronous DRAM)  
**DIMM Size:** 8MB, 16MB, 32MB, 64MB, 128MB

### Chipset

Intel 430TX PCIsset with built-in PCI EIDE

### Onboard I/O

ALI 5135 for two serial, one parallel, one floppy drive, and IrDA interface.

### **Onboard Bus Mastering EIDE**

Two EIDE interfaces for up to four devices, support PIO Mode 3/4 or Ultra DMA/33 IDE Hard Disk and ATAPI CD-ROM.

### **BIOS**

Licensed BIOS with additional features:

- FLASH EEPROM (128KB) for BIOS update
- ISA Plug and Play (PnP) extension
- Power management

### **Modem Ring-On**

This allows the PC to be turned on remotely through a modem via COM1 or COM2. (This feature requires an ATX power supply.)

### **Windows 95 Shut-Down**

This allows the PC to power off via Windows 95 operating system. (This feature requires an ATX power supply.)

### **PC 97 Compliance**

The new PC 97 requirements for systems and components are based on features such as support for Plug and Play compatibility and power management for configuring and managing all system components, and 32-bit device drivers and installation procedures for both Windows 95 and Windows NT.

### **Year 2000 Compliant BIOS**

The onboard Award BIOS is Year 2000 Compliant and will pass software applications that have the tendency to invoke INT1AH function 04H such as year2000.exe utility released by NSTL.

### **Hardware Monitoring (option)**

The optional hardware monitoring IC supports monitoring for CPU temperature, system temperature, system voltages and fan speed to warn the user against imminent system crashes.

### **Expansion Slots**

Four 32-bit PCI slots  
Two 16-bit ISA slots

### **Form Factor**

Baby AT, 7.29" x 8.6" (18.5cm x 21.8cm)

## **Chapter 3 Hardware Description**

This chapter briefly describes each of the major features of the AI5TT motherboard. The layout of the board is shown in Figure 1 which shows the locations of the key components. The topics covered in this chapter are as follows:

3.1 Processor and CPU Voltage.....	6
3.2 L2 Cache Memory .....	6
3.3 Main Memory .....	6
3.4 BIOS .....	8
3.5 Interrupt Request Lines (IRQ) .....	8
3.6 DMA Channels .....	9
3.7 I/O Port Address Map .....	9
3.8 Onboard PCI EIDE.....	10
3.9 Onboard Multi-I/O.....	10
3.10 System Hardware Monitor Device (optional) .....	10



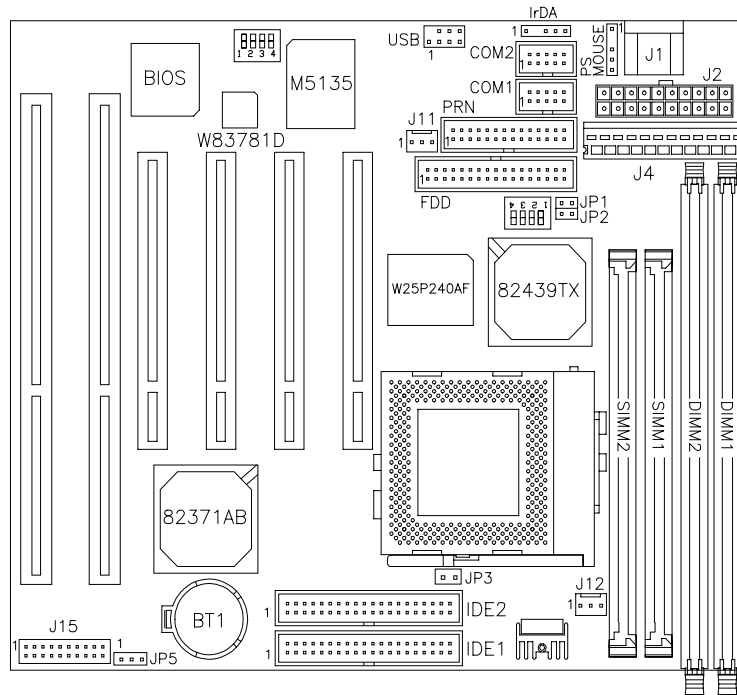

**Figure 1: Layout of the AI5TT Motherboard**

### **3.1 Processor and CPU Voltage**

The AI5TT is designed to take a Pentium Processor with a bus speed of 60 and 66MHz. Since the internal clock of the CPU can be multiples of 1.5, 2, 2.5, 3, 3.5, and 4 of the bus clock, the CPU frequency can be 90, 100, 120, 133, 150, 166, 200, 233 and 266MHz.

The onboard CPU Voltage provides support for CPUs Vcore which require voltages from 2.0V to 3.5V for a total of 16 different voltages.

### **3.2 L2 Cache Memory**

The AI5TT supports P.B. (Pipelined Burst) Synchronous Cache. The P.B. Synchronous Cache boosts the system's performance, 10% higher than regular Asynchronous Cache.

### **3.3 Main Memory**

The AI5TT motherboard supports four 72-pin SIMM and two 168-pin DIMM (Dual In-line Memory Module) sockets for a maximum total memory of 256MB. The DRAMs for the SIMM sockets can be 4MB, 8MB, 16MB, 32MB, and 64MB in EDO and FPM types. DIMM modules can be 8MB, 16MB, 32MB, 64MB and 128MB

The following should be noted when populating the SIMM/DIMM sockets:

1. SIMM1/SIMM2 DIMM1 and DIMM2 bank can be populated first.
2. Each bank\*\* should consist of the same size SIMMs.
3. Each bank should consist of the same type SIMMs. For example, *SIMM1 and SIMM2 are both be EDO or Page Mode.*

\*\* *Each bank consists of two SIMM slots or one DIMM slot. For example, SIMM 1 and SIMM 2 are considered as one bank and DIMM 1 as another one.*

## (1) 72-pin SIMM (5V)

Fast Page Mode/EDO DRAM

Bank0 (SIMM1, SIMM2)	Bank1 (SIMM3, SIMM4)	Total Memory
4MB×2	-----	8MB
8MB×2	-----	16MB
16MB×2	-----	32MB
64MB×2	-----	128MB

## (2) 168-pin DIMM (3.3V)

SDRAM or EDO DRAM

Bank0 (DIMM1)	Bank1 (DIMM2)	Total Memory
8MB	-----	8MB
16MB	-----	16MB
32MB	-----	32MB
64MB	-----	64MB
8MB	8MB	16MB
16MB	8MB	24MB
32MB	8MB	40MB
64MB	8MB	72MB
16MB	16MB	32MB
32MB	16MB	48MB
64MB	16MB	80MB
32MB	32MB	64MB
64MB	32MB	96MB
64MB	64MB	128MB
128MB	64MB	192MB
128MB	128MB	256MB

### 3.4 BIOS

The BIOS on the AI5TT motherboard provides the standard BIOS functions plus the following additional features:

#### 1. ISA Plug and Play (PnP) Extension

Unlike PCI cards which are plug and play, ISA cards require setting jumpers to resolve hardware conflicts. To make a computer system PnP, an ISA PnP standard is established and supported by new OSes, such as Windows 95. Under Windows 95, the motherboard BIOS must have ISA PnP extension to support the new ISA PnP cards.

#### 2. Power Management

The power management feature provides power savings by slowing down the CPU clock, turning off the monitor screen and stopping the HDD spindle motor.

### 3.5 Interrupt Request Lines (IRQ)

There are a total of 15 IRQ lines available on the motherboard. Peripheral devices use interrupt request lines to notify the CPU for the service required. The following table shows the IRQ used by the devices on the motherboard.

Level	Function
IRQ0	System Timer Output
IRQ1	Keyboard
IRQ2	Interrupt Cascade
IRQ3	Serial Port #2
IRQ4	Serial Port #1
IRQ5	Parallel Port #2
IRQ6	Floppy Disk Controller
IRQ7	Parallel Port #1
IRQ8	Real Time Clock
IRQ9	Software Redirected to Int 0Ah
IRQ10	Reserved
IRQ11	Reserved
IRQ12	Reserved
IRQ13	80287
IRQ14	Primary IDE
IRQ15	Secondary IDE

### 3.6 DMA Channels

There are seven DMA Channels available on the motherboard. Only DRQ2 is used by the floppy controller. In the case that ECP mode on the parallel port is used, DRQ1 or DRQ3 will be used.

### 3.7 I/O Port Address Map

Each peripheral device in the system is assigned a set of I/O port addresses which also becomes the identity of the device. There is a total of 1K port address space available. The following table lists the I/O port addresses used on the motherboard.

Address	Device Description
000h - 01Fh	DMA Controller #1
020h - 03Fh	Interrupt Controller #1
040h - 05Fh	Timer
060h - 06Fh	Keyboard Controller
070h - 07Fh	Real Time Clock, NMI
080h - 09Fh	DMA Page Register
0A0h - 0BFh	Interrupt Controller #2
0C0h - 0DFh	DMA Controller #2
0F0h	Clear Math Coprocessor Busy Signal
0F1h	Reset Math Coprocessor
1F0h - 1F7h	IDE Interface
278 - 27F	Parallel Port #2(LPT2)
2F8h - 2FFh	Serial Port #2(COM2)
2B0 - 2DF	Graphics adapter Controller
378h - 3FFh	Parallel Port #1(LPT1)
360 - 36F	Network Ports
3B0 - 3BF	Monochrome & Printer adapter
3C0 - 3CF	EGA adapter
3D0 - 3DF	CGA adapter
3F0h - 3F7h	Floppy Disk Controller
3F8h - 3FFh	Serial Port #1(COM1)

### **3.8 Onboard PCI EIDE**

The PCI EIDE controller is part of the 430TX PCIset. It supports PIO mode 3/4 and bus mastering. The peak transfer rate of PIO mode 3/4 can be as high as 17MB/sec. Using HDDs that support bus mastering, the peak transfer rate can reach 22MB/sec. There are two IDE connectors, primary IDE and secondary IDE. With two devices per connector, up to four IDE drives are supported.

The controller also supports Ultra DMA/33, a new "synchronous DMA" protocol featured in PIIX4. It is built on Intel's existing 16MB/s Bus Master interface to improve disk I/O throughput to 33MB/s. It uses both edges of data strobe to obtain 2X speed across the cable and is backward compatible with today's drives. It also has 16-bit CRC error detection across the cable for improved integrity.

### **3.9 Onboard Multi-I/O**

The onboard multi-I/O chip, ALI 5135, supports two 16550 UART-compatible serial ports, one high speed EPP/ECP parallel port, one floppy controller and IrDA function. The floppy controller supports 2.88MB format. The I/O port addresses of the serial and parallel ports are programmable via BIOS set-up.

### **3.10 System Hardware Monitor Device (optional)**

The optional Winbond W83781D System Hardware Monitor Device allows the system to track the PC health through hardware monitoring of the CPU and system temperature, voltage levels, and CPU and chassis fans to ensure the system's normal operation.



## Chapter 4 Configuring the AI5TT

The following sections describe the necessary procedures and proper jumper settings to configure the AI5TT motherboard.

- 4.1 SW1 (1-4), JP3, JP1: CPU Frequency Selector..... 13
- 4.2 SW2 (1-4): CPU Voltage Selector..... 16
- 4.3 JP5: Clear CMOS Content..... 18

For the locations of the jumpers, refer to Figure 2 on the following page.

The following shows the conventions used in this chapter.

	Jumper open
	Jumper closed (short)

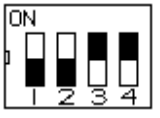
	<p>Switch 1 and switch 2 are set to OFF. Switch 3 and switch 4 are set to ON.</p>
<p>off off on on</p>	

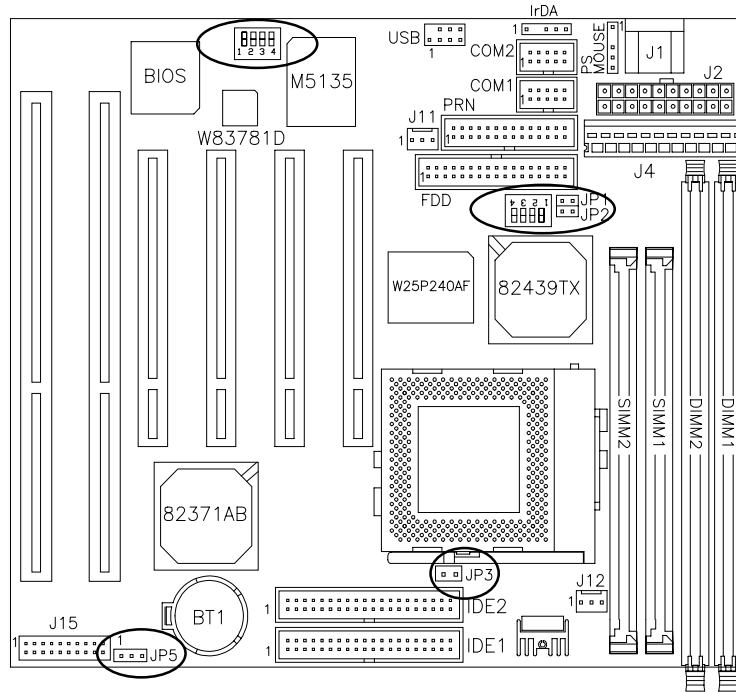
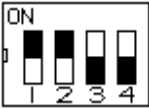
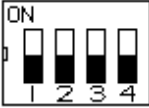
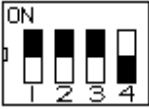
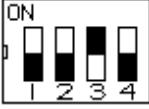
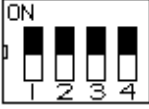

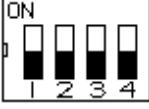

Figure 2: Jumper Location of the AI5TT







## 4.1 SW1 (1-4), JP3, JP1: CPU Frequency Selector

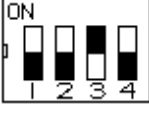

For Intel Pentium CPU

SW1 (1-4)	Switch Setting	Bus Clock Multiplier	CPU FREQ.
	1 2 3 4 on on off off	60MHz 1.5x	P54C-90
	1 2 3 4 off off off off	66MHz 1.5x	P54C-100
	1 2 3 4 on on on off	60MHz 2x	P54C-120
	1 2 3 4 off off on off	66MHz 2x	P54C-133
	1 2 3 4 on on on on	60MHz 2.5x	P54C-150
	1 2 3 4 off off on on	66MHz 2.5x	P54C/P55C-166
	1 2 3 4 off off off on	66MHz 3x	P54C/P55C-200
	1 2 3 4 off off off off	66MHz 3.5x	P55C-233





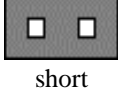

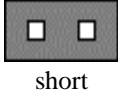
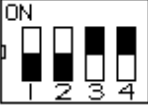
For AMD K5/K6 CPU

SW1 (1-4)	Switch Setting	Bus Clock Multiplier	CPU FREQ.
	1 2 3 4 off off off off	66MHz 1.5x	K5-PR100 (100MHz)
	1 2 3 4 off off on off	66MHz 2x	K5-PR133 (133MHz)
	1 2 3 4 off off on on	66MHz 1.75x	K5-PR166 (116.7MHz) K6/166
	1 2 3 4 off off off on	66MHz 3x	K6/200
	1 2 3 4 off off off off	66MHz 3.5x	K6/233

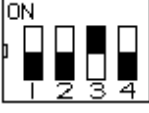
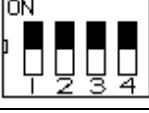
For AMD K6/266, K6/300 CPU







JP3	SW1 (1-4)	Switch Setting	Bus Clock Multiplier	CPU FREQ.
 short		1 2 3 4 off off on off	66MHz 4x	K6/266
 short		1 2 3 4 off off on on	66MHz 4.5x	K6/300

For Cyrix 6x86 and IDT C6 CPU

SW1 (1-4)	Switch Setting	Bus Clock Multiplier	CPU FREQ.
	1 2 3 4 on on on off	60MHz 2x	6x86(L)-P150+ (120MHz)
	1 2 3 4 off off on off	66MHz 2x	6x86(L)-P166+ (133MHz)
	1 2 3 4 on on on on	60MHz 2.5x	6x86MX-PR166
	1 2 3 4 off off on on	66MHz 2.5x	6x86MX-PR200
	1 2 3 4 off off off on	66MHz 3x	6x86MX-PR233
	1 2 3 4 off off off off	66MHz 3.5x	6x86MX-PR266
	1 2 3 4 on on off on	60MHz 3x	IDT C6-180*
	1 2 3 4 off off off on	66MHz 3x	IDT C6-200*

\*Single Voltage: 3.5V

For Cyrix 6x86MX CPU at 75MHz Bus

JP1	SW1 (1-4)	Switch Setting	Bus Clock Multiplier	CPU FREQ.
 short		1 2 3 4 off off on off	75MHz 2x	6x86MX PR200
 short		1 2 3 4 off off on on	75MHz 2.5x	6x86MX PR233
 short		1 2 3 4 off off off on	75MHz 3x	6x86MX PR266

**NOTE:** Intel 430TX is designed for 66MHz bus. 75MHz exceeds Intel 430TX specifications and is not guaranteed for normal operation.







#### 4.2 SW2 (1-4): CPU Voltage Selector

For Single Voltage CPU\*\*: Intel P54C, Cyrix 6x86,  
AMD K5, IDT C6

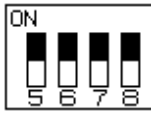
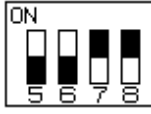
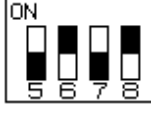
SW2 (1-4)	Switch Setting	VIO	VCORE
	5 6 7 8 on on on on	3.5V	3.5V

\*\*Default

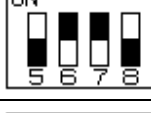
For Dual Voltage CPU: Intel P55C\*, Cyrix 6x86L/MX, AMD K6

SW2 (1-4)	Switch Setting	VIO	VCORE	CPU
	5 6 7 8 on on on on	3.3V	3.5V	
	5 6 7 8 off off on on	3.3V	3.2V	K6/233
	5 6 7 8 off on off on	3.3V	3.0V	
	5 6 7 8 on off off on	3.3V	2.9V	K6/166 K6/200
	5 6 7 8 off off off on	3.3V	2.8V	P55C 6x86L 6x86MX
	5 6 7 8 on on on off	3.3V	2.7V	
	5 6 7 8 off on on off	3.3V	2.6V	
	5 6 7 8 off on off off	3.3V	2.2V	K6/266 K6/300
	5 6 7 8 on off off off	3.3V	2.1V	K6/266 K6/300

\* P55C = Pentium MMX

### 4.3 JP5: Clear CMOS Content

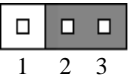
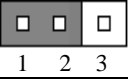
JP5	Jumper Setting	Function
 1 2 3	2-3 short	Clear CMOS Content
 1 2 3	1-2 short	Normal Operation

## Chapter 5 Installation

This chapter describes the connectors and interfaces that the AI5TT provides for creating a working system. Refer to Figure 3 for the location of the connectors.

The following items are covered in this chapter:

5.1 J1, J4: AT Keyboard and PS/2 Mouse Connectors.....	21
5.2 J2: ATX Power Supply Connector .....	21
5.3 J3: AT Power Connector .....	22
5.4 J5: Infrared Connector .....	22
5.5 J7, J6: Serial Ports .....	23
5.6 J8: Parallel Port Connector.....	23
5.7 J9: Floppy Drive Connector .....	24
5.8 J10: USB Connector .....	24
5.9 J11: Wake on LAN Connector .....	25
5.10 J12: CPU Fan Power Connector .....	25
5.11 J14, J13: IDE Connectors.....	26
5.12 J15: Front Bezel Connector .....	27

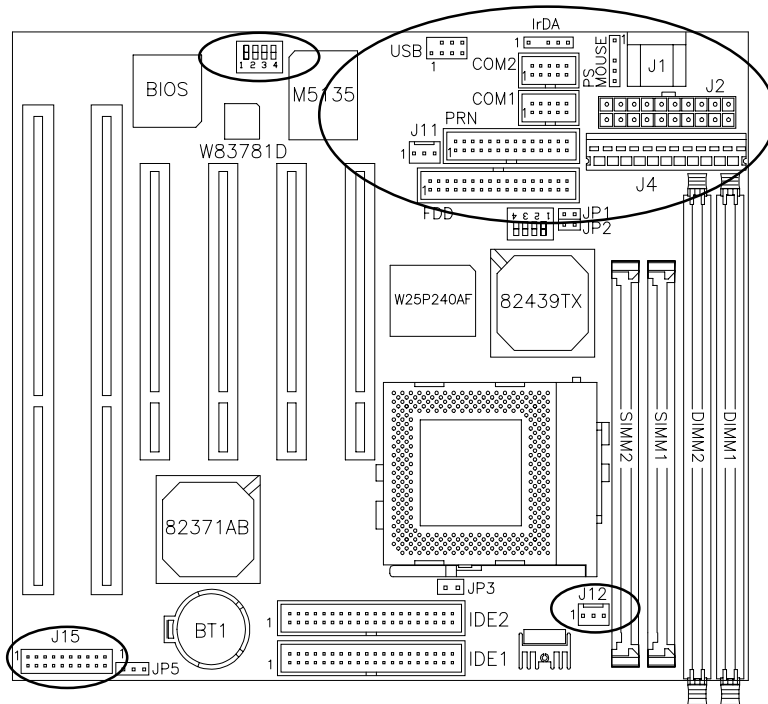
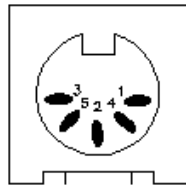

Figure 3: Connector Locations of the AI5TT



## 5.1 J1, J4: AT Keyboard and PS/2 Mouse Connectors

### J1: AT Keyboard Connector



Pin #	Signal Name
1	Keyboard data
2	N.C.
3	GND
4	5V
5	Keyboard clock
6	N.C.

### J4: PS/2 Mouse Connector



Pin #	Signal Name
1	Mouse data
2	N.C.
3	GND
4	Vcc
5	Mouse clock

## 5.2 J2: ATX Power Supply Connector

J2 is a 20-pin ATX power supply connector. Refer to the following table for the pin out assignments.

Signal Name	Pin #	Pin #	Signal Name
3.3V	11	1	3.3V
-12V	12	2	3.3V
Ground	13	3	Ground
PS-ON	14	4	+5V
Ground	15	5	Ground
Ground	16	6	+5V
Ground	17	7	Ground
-5V	18	8	Power good
+5V	19	9	5VSB
+5V	20	10	+12V

### 5.3 J3: AT Power Connector

When using an AT compatible power supply, plug both of the power supply connectors into J3. Make sure the power supply connectors are connected in the right orientation. The power supply connectors are connected in the right orientation if the black wires of each power cable are ADJACENT to each other. That is, black wires of each connector should be aligned in the center of the J3 power supply connector.

J3 Pin #		Description	Wire Color
1	⊖	Power Good	Orange
2	●	+5V	Red
3	●	+12V	Yellow
4	●	-12V	Blue
5	●	Ground	Black
6	●	Ground	Black
7	⊖	Ground	Black
8	●	Ground	Black
9	●	-5V	White
10	●	+5V	Red
11	●	+5V	Red
12	●	+5V	Red

### 5.4 J5: Infrared Connector

This connector is used for an IrDA connector for wireless communication with infrared devices.

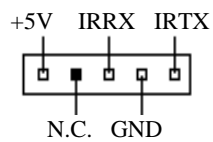

Pin #	Signal Name
1	+5V
2	No connect
3	Ir RX
4	Ground
5	Ir TX

### 5.5 J7, J6: Serial Ports

The onboard serial ports of the AI5TT are 10 pin-header connectors. J7 is COM1 and J6 is COM2. The following table shows the pin out of the these connectors.

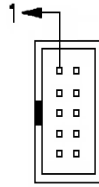

Pin #	Signal Name
1	DCD, Data carrier detect
2	RXD, Receive data
3	TXD, Transmit data
4	DTR, Data terminal ready
5	GND, ground
6	DSR, Data set ready
7	RTS, Request to send
8	CTS, Clear to send
9	RI, Ring indicator
10	Not Used

### 5.6 J8: Parallel Port Connector

The following table describes the pin out assignments of this connector.

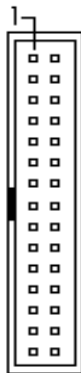

Signal Name	Pin #	Pin #	Signal Name
Line printer strobe	1	14	AutoFeed
PD0, parallel data 0	2	15	Error
PD1, parallel data 1	3	16	Initialize
PD2, parallel data 2	4	17	Select
PD3, parallel data 3	5	18	Ground
PD4, parallel data 4	6	19	Ground
PD5, parallel data 5	7	20	Ground
PD6, parallel data 6	8	21	Ground
PD7, parallel data 7	9	22	Ground
ACK, acknowledge	10	23	Ground
Busy	11	24	Ground
Paper empty	12	25	Ground
Select	13	N/A	N/A

### 5.7 J9: Floppy Drive Connector

J9 is a 34-pin header and will support up to 2.88MB floppy drives.



Signal Name	Pin #	Pin #	Signal Name
Ground	1	2	RM/LC
Ground	3	4	No connect
Ground	5	6	No connect
Ground	7	8	Index
Ground	9	10	Motor enable 0
Ground	11	12	Drive select 1
Ground	13	14	Drive select 0
Ground	15	16	Motor enable 1
Ground	17	18	Direction
Ground	19	20	Step
Ground	21	22	Write data
Ground	23	24	Write gate
Ground	25	26	Track 00
Ground	27	28	Write protect
Ground	29	30	Read data
Ground	31	32	Side 1 select
Ground	33	34	Diskette change

### 5.8 J10: USB Connector

J10 is the onboard USB headers for the optional USB connector. The following table shows the pin outs of these connectors.

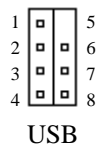

Pin #	Signal Name
1	5 Vcc
2	6 USB-
3	7 USB+
4	8 Ground

### 5.9 J11: Wake on LAN Connector

J11 is a 3-pin header for the Wake on LAN function on the motherboard. The following table shows the pin out assignments of this connector. Wake on LAN will function properly only with an ATX power supply with 5VSB that has 200mA.

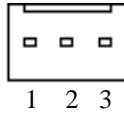

Pin #	Signal Name
1	+5VSB
2	Ground
3	Wake on LAN

### 5.10 J12: CPU Fan Power Connector

J12 is a 3-pin header for the CPU fan power connector. The fan must be a 12V fan.

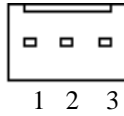

Pin #	Signal Name
1	Rotation
2	+12V
3	Ground

### 5.11 J14, J13: IDE Connectors

J14 and J13 are the *primary* and *secondary* IDE connectors.

#### J14: Primary IDE Connector

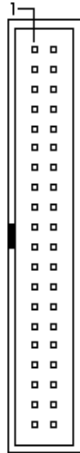

Signal Name	Pin #	Pin #	Signal Name
Reset IDE	1	2	Ground
Host data 7	3	4	Host data 8
Host data 6	5	6	Host data 9
Host data 5	7	8	Host data 10
Host data 4	9	10	Host data 11
Host data 3	11	12	Host data 12
Host data 2	13	14	Host data 13
Host data 1	15	16	Host data 14
Host data 0	17	18	Host data 15
Ground	19	20	Key
DRQ0	21	22	Ground
Host IOW	23	24	Ground
Host IOR	25	26	Ground
IOCHRDY	27	28	Host ALE
DACK0	29	30	Ground
IRQ14	31	32	No connect
Address 1	33	34	No connect
Address 0	35	36	Address 2
Chip select 0	37	38	Chip select 1
Activity	39	40	Ground

#### J13: Secondary IDE Connector

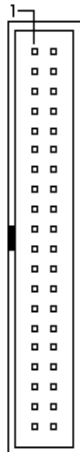

Signal Name	Pin #	Pin #	Signal Name
Reset IDE	1	2	Ground
Host data 7	3	4	Host data 8
Host data 6	5	6	Host data 9
Host data 5	7	8	Host data 10
Host data 4	9	10	Host data 11
Host data 3	11	12	Host data 12
Host data 2	13	14	Host data 13
Host data 1	15	16	Host data 14
Host data 0	17	18	Host data 15
Ground	19	20	Key
DRQ0	21	22	Ground
Host IOW	23	24	Ground
Host IOR	25	26	Ground
IOCHRDY	27	28	Host ALE
DACK1	29	30	Ground
MIRQ0	31	32	No connect
Address 1	33	34	No connect
Address 0	35	36	Address 2
Chip select 0	37	38	Chip select 1
Activity	39	40	Ground

### 5.12 J15: Front Bezel Connector

The front bezel of the case has a control panel which provides light indication of the computer activities and switches to change the computer's status. J15 is a 20-pin header that provides interfaces for the following functions.

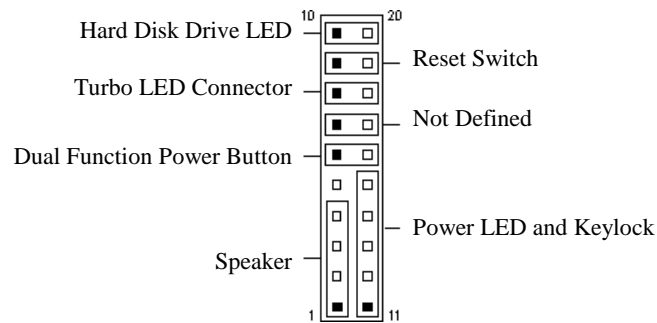

#### Speaker: Pins 1 - 4

This connector provides an interface to a speaker for audio tone generation. An 8-ohm speaker is recommended.



Pin #	Signal Name
1	Speaker out
2	No connect
3	Ground
4	+5V

#### Power LED and Keylock: Pins 11 - 15

The power LED indicates the status of the main power switch. The keylock switch, when closed, will disable the keyboard function.



Pin #	Signal Name
11	Power LED
12	No connect
13	Ground
14	Keylock
15	Ground

**Dual Function Power Button: Pin 6 and 16**

This connector provides two power modes: sleep and soft-off mode. Pushing the power button for less than 4 seconds places the system into sleep mode. Pressing the power button for more than 4 seconds puts the system into the soft-off mode. This function works for the ATX power supply only.

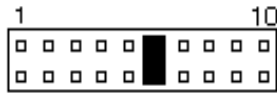

Pin #	Signal Name
6	Ground
16	Sleep

**Turbo LED Connector: Pins 8 and 18**

There is no turbo/deturbo function on the motherboard. The Turbo LED on the control panel will always be On when attached to this connector.

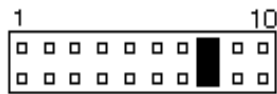

Pin #	Signal Name
8	5V
18	Ground

**Reset Switch: Pins 9 and 19**

The reset switch allows the user to reset the system without turning the main power switch Off and then On. Orientation is not required when making a connection to this header.

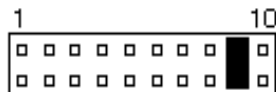

**Hard Disk Drive LED Connector: Pins 10 and 20**

This connector connects to the HDD activity LED on the control panel. This LED flashes when the HDD is being accessed.



Pin #	Signal Name
10	Ground
20	5V



## Chapter 6 BIOS Configuration

This chapter describes the different settings available in the Award BIOS that comes with the AI5TT motherboard. The topics covered in this chapter are as follows:

6.1 BIOS Introduction .....	32
6.2 BIOS Setup.....	32
6.3 Standard CMOS Setup .....	33
Date	
Time	
Primary HDDs / Secondary HDDs	
Drive A / Drive B	
Floppy 3 Mode Support	
Video	
Halt On	
6.4 BIOS Features Setup .....	37
Virus Warning	
CPU Internal Cache / External Cache	
Quick Power On Self Test	
Boot Sequence	
Swap Floppy Drive	
Boot Up Floppy Seek	
Boot Up NumLock Status	
Boot Up System Speed	
Gate A20 Option	
Typematic Rate Setting	
Typematic Rate (Chars/Sec)	
Typematic Delay (Msec)	
Security Option	
PCI/VGA Palette Snoop	
OS Select for DRAM > 64MB	
Video BIOS Shadow	
C8000 - CBFFF Shadow/DC000 - DFFFF Shadow	
6.5 Chipset Features Setup .....	40
DRAM Timing	
SDRAM (CAS Lat / RAS -to-CAS)	
System BIOS Cacheable	
Video BIOS Cacheable	

- Memory Hole at 15M-16M
- PCI 2.1 Compliance
- Power-Supply Type
- CPU Warning Temperature (option)
- Current System and CPU Temperature (option)
- CPU Fan Speed (option)
- Voltage Monitoring (option)
- 6.6 Power Management Setup .....42
  - Power Management
  - PM Control by APM
  - Video Off Method
  - Video Off After
  - Doze Mode
  - Standby Mode
  - Suspend Mode
  - HDD Power Down
  - VGA Active Monitor
  - Soft-Off by PWR-BTTN
  - IRQ 8 Break Suspend
  - Resume by Ring
  - Resume by Alarm
  - Reload Global Timer Events
- 6.7 PNP/PCI Configuration .....45
  - PNP OS Installed
  - Resources Controlled by
  - Reset Configuration Data
  - IRQ3/4/5/7/9/10/11/12/14/15, DMA0/1/3/5/6/7 assigned to
  - Used MEM base addr
- 6.8 Load BIOS Defaults.....47
- 6.9 Load Setup Defaults.....47
- 6.10 Integrated Peripherals .....48
  - IDE HDD Block Mode
  - IDE Primary/Secondary Master/Slave PIO
  - IDE Primary/Secondary Master/Slave UDMA
  - On-Chip Primary/Secondary PCI IDE
  - USB Keyboard Support
  - Onboard FDD Controller
  - Onboard Serial/Parallel Port
  - UR2 Mode

Parallel Port Mode

6.11 Supervisor / User Password .....	50
6.12 IDE HDD Auto Detection .....	51
6.13 HDD Low Level Format.....	51
6.14 Save & Exit Setup .....	52
6.15 Exit Without Saving .....	52

## **6.1 BIOS Introduction**

The Award BIOS (Basic Input/Output System) installed in your computer system's ROM supports Intel/Cyrix/AMD processors in a standard IBM-AT compatible I/O system. The BIOS provides critical low-level support for standard devices such as disk drives, serial and parallel ports. It also adds virus and password protection as well as special support for detailed fine-tuning of the chipset controlling the entire system.

## **6.2 BIOS Setup**

The Award BIOS provides a Setup utility program for specifying the system configurations and settings. The BIOS ROM of the system stores the Setup utility. When you turn on the computer, the Award BIOS is immediately activated. Pressing the <Del> key immediately allows you to enter the Setup utility. If you are a little bit late pressing the <Del> key, POST(Power On Self Test) will continue with its test routines, thus preventing you from invoking the Setup. If you still wish to enter Setup, restart the system by pressing the "Reset" button or simultaneously pressing the <Ctrl>, <Alt> and <Delete> keys. You can also restart by turning the system Off and back On again. The following message will appear on the screen:

```
Press <DEL> to Enter Setup
```

In general, you press the arrow keys to highlight items, <Enter> to select, the <PgUp> and <PgDn> keys to change entries, <F1> for help and <Esc> to quit.

When you enter the Setup utility, the Main Menu screen will appear on the screen. The Main Menu allows you to select from various setup functions and exit choices.

ROM PCI/ISA BIOS  
CMOS SETUP UTILITY  
AWARD SOFTWARE, INC.

<b>STANDARD CMOS SETUP</b>	INTEGRATED PERIPHERALS
BIOS FEATURES SETUP	SUPERVISOR PASSWORD
CHIPSET FEATURES SETUP	USER PASSWORD
POWER MANAGEMENT SETUP	IDE HDD AUTO DETECTION
PNP/PCI CONFIGURATION	HDD LOW LEVEL FORMAT
LOAD BIOS DEFAULTS	SAVE & EXIT SETUP
LOAD SETUP DEFAULTS	EXIT WITHOUT SAVING
ESC : Quit	↑ ↓ → ← : Select Item
F10 : Save & Exit Setup	(Shift) F2 : Change Color
Time, Date, Hard Disk Type	

The section below the setup items of the Main Menu displays the control keys for this menu. Another section at the bottom of the Main Menu just below the control keys section displays information on the currently highlighted item in the list.

**NOTE:** *After making and saving system changes with Setup, you find that your computer cannot boot, the Award BIOS supports an override to the CMOS settings that resets your system to its default.*

*It is strongly recommended that you avoid making any changes to the chipset defaults. These defaults have been carefully chosen by both Award and your system manufacturer to provide the absolute maximum performance and reliability.*

### 6.3 Standard CMOS Setup

“Standard CMOS Setup” choice allows you to record some basic hardware configurations in your computer system and set the system clock and error handling. If the motherboard is already installed in a working system, you will not need to select this option. You will need to run the Standard CMOS option, however, if you change your system hardware configurations, the onboard battery fails, or the configuration stored in the CMOS memory was lost or damaged.

ROM PCI/ISA BIOS  
STANDARD CMOS SETUP  
AWARD SOFTWARE, INC.

Date (mm:dd:yy) : Wed, Jan 1 1997								
Time (hh:mm:ss) : 00 : 00 : 00								
HARD DISKS	TYPE	SIZE	CYLS	HEAD	PRECOMP	LANDZ	SECTOR	MODE
Primary Master	Auto	0	0	0	0	0	0	Auto
Primary Slave	None	0	0	0	0	0	0	-----
Secondary Master	None	0	0	0	0	0	0	-----
Secondary Slave	None	0	0	0	0	0	0	-----
Drive A	: 1.44M, 3.5 in				Base Memory		:	640K
Drive B	: None				Extended Memory		:	31744K
Floppy 3 Mode Support	: Disabled				Other Memory		:	384K
Video	: EGA / VGA				Total Memory		:	32768K
Halt On	: All Errors							
ESC : Quit	↑ ↓ → ← : Select		Item	PU / PD / + / - : Modify				
F1 : Help	(Shift) F2 : Change Color							

At the bottom of the menu are the control keys for use on this menu. If you need any help in each item field, you can press the <F1> key. It will display the relevant information to help you. The memory display at the lower right-hand side of the menu is read-only. It will adjust automatically according to the memory changed. The following describes each item of this menu.

**Date**

The date format is:

- Day :** Sun to Sat
- Month :** 1 to 12
- Date :** 1 to 31
- Year :** 1900 to 2099

To set the date, highlight the "Date" field and use the PageUp/ PageDown or +/- keys to set the current time.

**Time**

The time format is: **Hour : 00 to 23**  
**Minute : 00 to 59**  
**Second : 00 to 59**

To set the time, highlight the "Time" field and use the <PgUp>/ <PgDn> or +/- keys to set the current time.

### Primary HDDs / Secondary HDDs

The onboard PCI IDE connectors provide Primary and Secondary channels for connecting up to four IDE hard disks or other IDE devices. Each channel can support up to two hard disks; the first is the “Master” and the second is the “Slave”.

To enter the specifications for a hard disk drive, you must select first a “Type”. There are 45 predefined types and 4 user definable types are for Enhanced IDE BIOS. Type 1 to 45 are predefined. Type “User” is user-definable. For the Primary Master/Slave as well as Secondary Master/Slave, you can select “Auto” under the TYPE and MODE fields. This will enable auto detection of your IDE drives and CD-ROM drive during POST.

Press <PgUp>/<PgDn> to select a numbered hard disk type or type the number and press the <Enter> key. The hard disk will not work properly if you enter incorrect information for this field. If your hard disk drive type is not matched or listed, you can use Type User to define your own drive type manually. If you select Type User, related information is asked to be entered to the following items.

**CYLS :**           Number of cylinders  
**HEAD :**           Number of read/write heads  
**PRECOMP :**      Write precompensation  
**LANDZ :**         Landing zone  
**SECTOR :**        Number of sectors  
**SIZE :**           Automatically adjust according to the configuration  
**MODE (for IDE HDD only) :**   Auto  
                          Normal (HD < 528MB)  
                          Large   (for MS-DOS only)  
                          LBA    (HD > 528MB and supports  
                                  Logical Block Addressing)

***NOTE:** The specifications of your drive must match with the drive table. The hard disk will not work properly if you enter incorrect information in these fields. If your hard disk drive type is not matched or listed, you can use Type User to define your own drive type manually.*

### Drive A / Drive B

These fields identify the types of floppy disk drive, A or drive B, that has been installed in the computer. The available specifications are:

360KB	1.2MB	720KB	1.44MB	2.88MB
5.25 in.	5.25 in.	3.5 in.	3.5 in.	3.5 in.

### Floppy 3 Mode Support

This is the Japanese standard floppy drive. The standard stores 1.2MB in a 3.5-inch diskette. You have four options to choose:

- Disabled                      No 3 mode floppy drive installed. (default)
- Drive A                        Installed 3 mode drive at drive A.
- Drive B                        Installed 3 mode drive at drive B.
- Both                            Installed 3 mode drive at drive A and B.

### Video

This field selects the type of video display card installed in your system. You can choose the following video display cards:

- EGA/VGA                      For EGA, VGA, SEGA, SVGA or PGA monitor adapters.(default)
- CGA 40                        Power up in 40 column mode.
- CGA 80                        Power up in 80 column mode.
- MONO                         For Hercules or MDA, includes high resolution monochrome adapters.

### Halt On

This field determines whether the system will halt if an error is detected during power up.

- No errors                      Whenever the BIOS detects a non-fatal error, the system will be halted and you will be prompted.
- All errors                      The system boot will not be halted for any error that may be detected. (default)
- All, But Keyboard            The system boot will not be halted for a keyboard error; it will stop for all other errors.
- All, But Diskette            The system boot will not be halted for a disk error; it will stop for all other errors.
- All, But Disk/Key            The system boot will not be halted for a keyboard or disk error; it will stop for all other errors.



## 6.4 BIOS Features Setup

This section allows you to configure and improve your system and allows you to set up some system features according to your preference.

ROM / PCI ISA BIOS BIOS FEATURES SETUP AWARD SOFTWARE, INC.			
Virus Warning	: Disabled	Video BIOS Shadow	: Enabled
CPU Internal Cache	: Enabled	C8000-CBFFF Shadow	: Disabled
External Cache	: Enabled	CC000-CFFFF Shadow	: Disabled
Quick Power On Self Test	: Enabled	D0000-D3FFF Shadow	: Disabled
Boot Sequence	: A, C, SCSI	D4000-D7FFF Shadow	: Disabled
Swap Floppy Drive	: Disabled	D8000-DBFFF Shadow	: Disabled
Boot Up Floppy Drive	: Enabled	DC000-DFFF Shadow	: Disabled
Boot Up Numlock Status	: On		
Boot Up System Speed	: High		
Gate A20 Option	: Fast		
Typematic Rate Setting	: Disabled		
Typematic Rate (chars/Sec)	: 6		
Typematic Delay (Msec)	: 250		
Security Option	: Setup		
PCI /VGA Palette Snoop	: Disabled		
OS Select For DRAM>64MB	: Non-OS2		
		ESC : Quit	↑ ↓ → ← : Select Item
		F1 : Help	PU/PD/+/- : Modify
		F5 : Old Values	(Shift) F2 : Color
		F6 : Load BIOS Defaults	
		F7 : Load Setup Defaults	

### Virus Warning

This item protects the boot sector and partition table of your hard disk against accidental modifications. If an attempt is made, the BIOS will halt the system and display a warning message. If this occurs, you can either allow the operation to continue or run an anti-virus program to locate and remove the problem.

*NOTE: Many disk diagnostic programs which attempt to access the boot sector table can cause the virus warning. If you will run such a program, disable the Virus Warning feature.*

### CPU Internal Cache / External Cache

These items allow you to enable (speed up memory access) or disable the cache function. By default, these items are **Enabled**.

**Quick Power On Self Test**

This choice speeds up the Power On Self Test (POST) after you power up the system. If it is set to *Enabled*, BIOS will skip some items. By default, this choice is *Enabled*.

**Boot Sequence**

This field determines the drive that the system searches first for an operating system. The options are :

A, C, SCSI	D, A, SCSI	SCSI, C, A
C, A, SCSI	E, A, SCSI	C only
C, CDROM, A	F, A, SCSI	LS120, C
CDROM, C, A	SCSI, A, C	

The default value is *A, C, SCSI*.

**Swap Floppy Drive**

This item allows you to determine whether to enable Swap Floppy Drive or not. When enabled, the BIOS swaps floppy drive assignments so that Drive A becomes Drive B, and Drive B becomes Drive A. By default, this field is set to *Disabled*.

**Boot Up Floppy Seek**

When enabled, the BIOS will seek whether or not the floppy drive installed has 40 or 80 tracks. 360K type has 40 tracks while 760K, 1.2M and 1.44M all have 80 tracks. By default, this field is set to *Enabled*.

**Boot Up NumLock Status**

This allows you to activate the NumLock function after you power up the system. By default, the system boots up with *NumLock* On.

**Boot Up System Speed**

This has no function and selects the default system speed (*High*).

**Gate A20 Option**

This field allows you to select how Gate A20 is worked. The Gate A20 is a device used to address memory above 1 MB. By default, this field is set to *Fast*.

**Typematic Rate Setting**

When disabled, continually holding down a key on your keyboard will generate only one instance. When enabled, you can set the two typematic controls listed next. By default, this field is set to *Disabled*.

**Typematic Rate (Chars/Sec)**

When the typematic rate is enabled, the system registers repeated keystrokes speeds. You can select speed range from 6 to 30 characters per second. By default, this item is set to **6**.

**Typematic Delay (Msec)**

When the typematic rate is enabled, this item allows you to set the time interval for displaying the first and second characters. By default, this item is set to **250msec**.

**Security Option**

This field allows you to limit access to the System and Setup. The default value is **Setup**. When you select **System**, the system prompts for the User Password every time you boot up. When you select **Setup**, the system always boots up and prompts for the Supervisor Password only when the Setup utility is called up.

**PCI/VGA Palette Snoop**

Some display cards that are non-standard VGA may not show colors properly. This field allows you to set whether MPEG ISA/VESA VGA Cards can work with PCI/VGA or not. When this field is enabled, a PCI/VGA can work with a MPEG ISA/VESA VGA card. When this field is disabled, a PCI/VGA cannot work with a MPEG ISA/VESA Card.

**OS Select for DRAM > 64MB**

This option allows the system to access greater than 64MB of DRAM memory when used with OS/2 that depends on certain BIOS calls to access memory. The default setting is **NON-OS/2**.

**Video BIOS Shadow**

This item allows you to change the Video BIOS location from ROM to RAM. Video Shadow will increase the video speed.

**C8000 - CBFFF Shadow/DC000 - DFFFF Shadow**

Shadowing a ROM reduces the memory available between 640KB to 1024KB. These fields determine whether optional ROM will be copied to RAM or not.

### 6.5 Chipset Features Setup

This Setup menu controls the configuration of the motherboard chipset.

ROM PCI/ISA BIOS  
CHIPSET FEATURES SETUP  
AWARD SOFTWARE INC.

DRAM Timing : 70ns SDRAM (CAS Lat/RAS-to-CAS) : 3/3 System BIOS Cacheable : Disabled Video BIOS Cacheable : Enabled Memory Hole At 15M-16M : Disabled PCI 2.1 Compliance : Disabled	Power-Supply Type : Auto CPU Warning Temperature : 70°C/158°F Current System Temp. : 25°C/77°F Current CPU Temperature : 37°C/98°F Current CPUFAN Speed : 5720 RPM  VIO : 3.31 V VCORE : 2.84V +12 V : 11.26V +5 V : 5.11V - 5 V : -4.84V -12 V : -10.93V  ESC : Quit                    ↑ ↓ → ← : Select Item F1 : Help                     PU/PD/+/- : Modify F5 : Old Values             (Shift) F2 : Color F6 : Load BIOS Defaults F7 : Load Setup Defaults
--	---

#### DRAM Timing

The DRAM timing is controlled by the DRAM Timing Registers. The timing type is dependent on the system design. Slower rates may be required in some system designs to support loose layouts or slower memory.

#### SDRAM (CAS Lat / RAS -to-CAS)

This item allows you to select the CAS# latency for all SDRAM cycles and RAS# to CAS# delay.

2/2	The timing type.
3/3	The timing type.

#### System BIOS Cacheable

When enabled, access to the system BIOS ROM addressed at F0000H-FFFFFH are cached, provided that the cache controller is disabled.

#### Video BIOS Cacheable

When enabled, access to video BIOS addressed at C0000H to C7FFFH are cached, provided that the cache controller is enabled.

**Memory Hole at 15M-16M**

In order to improve performance, certain space in memory can be reserved for ISA cards. This field allows you to reserve 15MB to 16MB memory address space to ISA expansion cards. This makes memory from 15MB and up unavailable to the system. Expansion cards can only access memory up to 16MB. By default, this field is set to *Disabled*.

**PCI 2.1 Compliance**

Concurrent PCI allows multiple PCI transfers from the PCI master buses to memory to CPU. By default, this field is set to *Disabled*.

**Power-Supply Type**

This field allows you to select the type of power supply used. The settings are *Auto*, *P8&P9*, or *ATX*. The default setting is *Auto*.

P8&P9	AT power supply type.
ATX	ATX power supply type

**CPU Warning Temperature (option)**

The onboard hardware thermal sensor monitors CPU temperature changes and prevents the CPU from overheating. Alert is sounded through the speaker and CPU speed slows down when the temperature exceeds the assigned warning temperature until the temperature falls below a safe level.

**Current System and CPU Temperature (option)**

These fields show the current system and system temperature as monitored by the sensor under the CPU. This is a function of the System Hardware Monitoring Device.

**CPU Fan Speed (option)**

These fields show the RPM (revolution per minute) status of your CPU fan and Chassis fan. This is a function of the System Hardware Monitoring Device.

**Voltage Monitoring (option)**

These fields show the monitored current voltages in the voltage regulators and the system's power supply. This is a function of the System Hardware Monitoring Device.

## 6.6 Power Management Setup

The Power Management Setup allows you to save energy of your system effectively. It will shut down the hard disk and turn off video display after a period of inactivity.

ROM PCI/ISA BIOS POWER MANAGEMENT SETUP AWARD SOFTWARE, INC.			
Power Management	: User Define	** Reload Global Timer Events **	
PM Control by APM	: Yes	IRQ3 [ 3-7, 9-15],NMI	: Enabled
Video Off Method	: V/H SYNC +Blank	Primary IDE 0	: Disabled
Video Off After	: Suspend	Primary IDE 1	: Disabled
MODEM Use IRQ	: 3	Secondary IDE 0	: Disabled
Doze Mode	: Disabled	Secondary IDE 1	: Disabled
Standby Mode	: Disabled	Floppy Disk	: Disabled
Suspend Mode	: Disabled	Serial Port	: Enabled
HDD Power Down	: Disabled	Parallel Port	: Disabled
Throttle Duty Cycle	: 62.5%		
VGA Active Monitor	: Enabled		
Soft-off by PWR-BTTN	: Instant Off		
IRQ 8 Break Suspend	: 8		
Resume by Ring	: Disabled	ESC : Quit	↑ ↓ → ← : Select Item
Resume by Alarm	: Disabled	F1 : Help	PU/PD/+/- : Modify
		F5 : Old Values	(Shift) F2 : Color
		F6 : Load BIOS Defaults	
		F7 : Load Setup Defaults	

### Power Management

This field allows you to select the type of power saving management modes. There are four selections for Power Management.

Disable	No power management. (Default)
Min. Power Saving	Minimum power management.
Max. Power Saving	Maximum power management. Only available for SL CPU.
User Define	Each of the ranges are from 1 min. to 1hr. Except for HDD Power Down which ranges from 1 min. to 15 min.

### PM Control by APM

This field allows you to use the Advanced Power Management device to enhance the Max. Power Saving mode and stop the CPU's internal clock. If the Max. Power Saving is not enabled, this will be preset to NO.

### Video Off Method

This field defines the Video Off features. There are three options.

V/H SYNC + Blank	Default setting, blank the screen and turn off vertical and horizontal scanning.
DPMS	Allows the BIOS to control the video display card if it supports the DPMS feature.
Blank Screen	This option only writes blanks to the video buffer.

### Video Off After

This field specifies the mode after which the Video Off feature is enabled. The options are *Doze*, *Standby*, *Suspend* and *N/A*.

### MODEM Use IRQ

This field defines the IRQ used by the modem. By default, the IRQ is set to 3.

### Doze Mode

When enabled, and after the set time of system inactivity, the CPU clock will run at a slower speed while all other devices still operate at full speed.

### Standby Mode

When enabled, and after the set time of system inactivity, the fixed disk drive and the video would be shut off while all other devices still operate at full speed.

### Suspend Mode

When enabled, and after the set time of system inactivity, all devices except the CPU will be shut off.

### HDD Power Down

When enabled, and after the set time of system inactivity, the hard disk drive will be powered down while all other devices remain active.

### Throttle Duty Cycle

When the system enters Doze mode, the CPU clock runs only part of the time. You may select the percent of time that the clock runs.

**VGA Active Monitor**

This option specifies if the BIOS is to monitor activity on the display monitor for power conservation purposes.

**Soft-Off by PWR-BTTN**

This field specifies the power-off mode of the ATX system. The *Instant Off Mode* allows powering off immediately upon pressing the power button. In the *Delay 4 Secs Mode*, the system powers off after pressing the power button for more than four seconds. By default, this field is set to *Instant Off*.

**IRQ 8 Break Suspend**

You can enable or disable monitoring of IRQ8 (the Real Time Clock) so it does not awaken the system from Suspend mode.

**Resume by Ring**

This allows a computer to be turned on remotely through a modem. By default, this field is set to *Disabled*.

**Resume by Alarm**

This allows a computer to be turned on automatically through the timer set in the BIOS to make the system more scheduleable. By default, this field is set to *Disabled*.

**Reload Global Timer Events**

This section determines the reloading of the 'timers' after entering the Full On mode. When enabled, the item reloads the set time of inactivity before entering the power saving mode.



### 6.7 PNP/PCI Configuration

This option configures the PCI bus system. All PCI bus systems on the system use INT#, thus all installed PCI cards must be set to this value.

ROM PCI/ISA BIOS PNP/PCI CONFIGURATION AWARD SOFTWARE INC.			
PNP OS Installed	: No	Used MEM base addr	: N/A
Resources Controlled by	: Manual		
Reset Configuration Data	: Disabled		
IRQ-3 assigned to	: Legacy ISA		
IRQ-4 assigned to	: Legacy ISA		
IRQ-5 assigned to	: PCI/ISA PnP		
IRQ-7 assigned to	: Legacy ISA		
IRQ-9 assigned to	: PCI/ISA PnP		
IRQ-10 assigned to	: PCI/ISA PnP		
IRQ-11 assigned to	: PCI/ISA PnP		
IRQ-12 assigned to	: PCI/ISA PnP		
IRQ-14 assigned to	: PCI/ISA PnP		
IRQ-15 assigned to	: PCI/ISA PnP		
DMA-0 assigned to	: PCI/ISA PnP		
DMA-1 assigned to	: PCI/ISA PnP	ESC : Quit	↑ ↓ ← : Select Item
DMA-3 assigned to	: PCI/ISA PnP	F1 : Help	PU/PD/+/- : Modify
DMA-5 assigned to	: PCI/ISA PnP	F5 : Old Values	(Shift) F2 : Color
DMA-6 assigned to	: PCI/ISA PnP	F6 : Load BIOS Defaults	
DMA-7 assigned to	: PCI/ISA PnP	F7 : Load Setup Defaults	

#### PNP OS Installed

This field allows you to specify if the operating system installed in your system is plug and play aware.

**NOTE:** Operating systems such as DOS, OS/2, and Windows 3.x do not use PnP.

#### Resources Controlled by

This PnP BIOS can configure all of the boot and compatible devices automatically. However, this capability needs you to use a PnP operating system such as Windows 95. The default value is **Manual**.

#### Reset Configuration Data

This field allows you to determine whether to reset the configuration data or not. The default value is **Disabled**.

#### IRQ3/4/5/7/9/10/11/12/14/15, DMA0/1/3/5/6/7 assigned to

These fields allow you to determine the IRQ/DMA assigned to the ISA bus and is not available to any PCI slot.

**Used MEM base addr**

This field allows the user to set the base address and block size of a legacy (non-PnP) ISA card that uses any memory segment within the C800H and DFFFH address range. If the you have such a card and are not using an ICU (ISA Configuration Utility) to specify its address range, select a base address from the six available options. During selection, the "Used MEM Length" field will appear with the block size options. If you have more than one legacy ISA card in your system that require the use of this address range, you can increase the block size to either 8K, 16K, 32K or 64K. If you are using ICU to accomplish this task, leave "Used MEM base addr" to its default setting of N/A.

### 6.8 Load BIOS Defaults

This option allows you to load the troubleshooting default values permanently stored in the BIOS ROM. These default settings are non-optimal and disable all high-performance features.

ROM PCI/ISA BIOS  
CMOS SETUP UTILITY  
AWARD SOFTWARE, INC.

STANDARD CMOS SETUP	INTEGRATED PERIPHERALS
BIOS FEATURES SETUP	SUPERVISOR PASSWORD
CHIPSET FEATURES SETUP	USER PASSWORD
POWER MANAGEMENT	DETECTION
PNP/PCI CONFIGURATION	FORMAT
<b>LOAD BIOS DEFAULTS</b>	UP
LOAD SETUP DEFAULTS	EXIT WITHOUT SAVING
ESC : Quit	↑ ↓ → ← : Select Item
F10 : Save & Exit Setup	(Shift) F2 : Change Color
Load BIOS Defaults except Standard CMOS Setup	

To load BIOS defaults value to CMOS SRAM, enter “Y”. If not, enter “N”.

### 6.9 Load Setup Defaults

This option allows you to load the default values to your system configuration. These default settings are optimal and enable all high performance features.

ROM PCI/ISA BIOS  
CMOS SETUP UTILITY  
AWARD SOFTWARE, INC.

STANDARD CMOS SETUP	INTEGRATED PERIPHERALS
BIOS FEATURES SETUP	SUPERVISOR PASSWORD
CHIPSET FEATURES SETUP	USER PASSWORD
POWER MANAGEMENT	DETECTION
PNP/PCI CONFIGURATION	FORMAT
LOAD BIOS DEFAULTS	UP
<b>LOAD SETUP DEFAULTS</b>	EXIT WITHOUT SAVING
ESC : Quit	↑ ↓ → ← : Select Item
F10 : Save & Exit Setup	(Shift) F2 : Change Color
Load BIOS Defaults except Standard CMOS Setup	

To load SETUP defaults value to CMOS SRAM, enter “Y”. If not, enter “N”.

### 6.10 Integrated Peripherals

This option allows you to determine your hard disk configuration, mode and port.

ROM PCI/ISA BIOS  
INTEGRATED PERIPHERALS  
AWARD SOFTWARE INC.

IDE HDD Block Mode	: Enabled	Onboard Parallel Mode	: 378/IRQ7
IDE Primary Master PIO	: Auto	Parallel Port Mode	: SPP
IDE Primary Slave PIO	: Auto		
IDE Secondary Master PIO	: Auto		
IDE Secondary Slave PIO	: Auto		
IDE Primary Master UDMA	: Auto		
IDE Primary Slave UDMA	: Auto		
IDE Secondary Master UDMA	: Auto		
IDE Secondary Slave UDMA	: Auto		
On-Chip Primary PCI IDE	: Enabled		
On-Chip Secondary PCI IDE	: Enabled		
USB Keyboard Support	: Disabled		
Onboard FDD Controller	: Enabled	ESC : Quit	↑ ↓ ← : Select Item
Onboard Serial Port 1	: 3F8/IRQ4	F1 : Help	PU/PD/+/- : Modify
Onboard Serial Port 2	: 2F8/IRQ3	F5 : Old Values	(Shift) F2 : Color
UR2 Mode	: Normal	F6 : Load BIOS Defaults	
		F7 : Load Setup Defaults	

#### IDE HDD Block Mode

This field allows your hard disk controller to use the fast block mode to transfer data to and from your hard disk drive.

#### IDE Primary Master/Slave PIO And Secondary Master/Slave PIO

These fields allow your system hard disk controller to work faster. Rather than have the BIOS issue a series of commands that transfer to or from the disk drive, PIO (Programmed Input/Output) allows the BIOS to communicate with the controller and CPU directly.

The system supports five modes, numbered from 0 (default) to 4, which primarily differ in timing. When Auto is selected, the BIOS will select the best available mode.

#### IDE Primary Master/Slave UDMA And Secondary Master/Slave UDMA

This field allows your system to improve disk I/O throughput to 33Mb/sec with the Ultra DMA/33 feature. The options are *Auto* and *Disabled*.

**On-Chip Primary/Secondary PCI IDE**

These fields allow you either to enable or disable the Primary/Secondary controller. You might choose to disable the controller if you were to add a higher performance or specialized controller.

**USB Keyboard Support**

This field allows your system to support a USB keyboard.

**Onboard FDD Controller**

This option allows you to select the onboard FDD port.

**Onboard Serial/Parallel Port**

These fields allow you to select the onboard serial and parallel port and their addresses. The default value for these ports are:

Serial Port 1	3F8/IRQ4
Serial Port 2	2F8/IRQ3
Parallel Port	378H/IRQ7

**UR2 Mode**

This field selects an operating mode for the second serial port.

**Parallel Port Mode**

This field allows you to determine parallel port mode function.

SPP	Normal Printer Port
EPP	Enhanced Parallel Port
ECP	Extended Capabilities Port

### 6.11 Supervisor / User Password

These two options set the system password. *Supervisor Password* sets a password that will be used to protect the system and Setup utility. *User Password* sets a password that will be used exclusively on the system. To specify a password, highlight the type you want and press <Enter>. The **Enter Password:** message prompts on the screen. Type the password, up to eight characters in length, and press <Enter>. The system confirms your password by asking you to type it again. After setting a password, the screen automatically returns to the main screen.

To disable a password, just press the <Enter> key when you are prompted to enter the password. A message will confirm the password to be disabled. Once the password is disabled, the system will boot and you can enter Setup freely.

ROM PCI/ISA BIOS  
CMOS SETUP UTILITY  
AWARD SOFTWARE, INC.

STANDARD CMOS SETUP	INTEGRATED PERIPHERALS
BIOS FEATURES SETUP	<b>SUPERVISOR PASSWORD</b>
CHIPSET FEATURES SETUP	USER PASSWORD
POWER MANAGEMENT SETUP	IDE HDD AUTO DETECTION
PNP/PCI CONFIGURATION	FORMAT
LOAD BIOS DEFAULTS	UP
LOAD SETUP DEFAULTS	AVING
ESC : Quit	↑ ↓ → ← : Select Item
F10 : Save & Exit Setup	(Shift) F2 : Change Color
Change / Set / Disable Password	

### 6.12 IDE HDD Auto Detection

This option detects the parameters of an IDE hard disk drive, and automatically enters them into the Standard CMOS Setup screen.

ROM PCI/ISA BIOS  
STANDARD CMOS SETUP  
AWARD SOFTWARE, INC.

HARD DISKS	TYPE	SIZE	CYLS	HEAD	PRECOMP	LANDZ	SECTOR	MODE
Primary Master:								
Select Primary Master Option (N=SKIP) : N								
OPTIONS	TYPE	SIZE	CYLS	HEAD	PRECOMP	LANDZ	SECTOR	MODE
1 (Y)	0	0	0	0	0	0	0	NORMAL
NOTE: Some OSes (like SCO-UNIX) must use "NORMAL" for installation								

Up to four IDE drives can be detected, with parameters for each appearing in sequence inside a box. To accept the displayed entries, press the "Y" key; to skip to the next drive, press the "N" key. If you accept the values, the parameters will appear listed beside the drive letter on the screen.

### 6.13 HDD Low Level Format

This option should only be used by a professional. Low-level formatting can cause irreparable damage to your hard disk. The procedures include selecting the drive you want to low-level format, determining the bad tracks, and proceeding with pre-formatting.

### 6.14 Save & Exit Setup

This option allows you to determine whether to accept the modifications or not. If you type "Y", you will quit the setup utility and save all changes into the CMOS memory. If you type "N", you will return to Setup utility.

ROM PCI/ISA BIOS  
CMOS SETUP UTILITY  
AWARD SOFTWARE, INC.

STANDARD CMOS SETUP	INTEGRATED PERIPHERALS
BIOS FEATURES SETUP	SUPERVISOR PASSWORD
CHIPSET FEATURES SETUP	USER PASSWORD
POWER MANAGE	DETECTION
PNP/PCI CONF	FORMAT
LOAD BIOS DEF	UP
LOAD SETUP DEFAULTS	EXIT WITHOUT SAVING
ESC : Quit	↑ ↓ → ← : Select Item
F10 : Save & Exit Setup	(Shift) F2 : Change Color
Save Data to CMOS & Exit Setup	

### 6.15 Exit Without Saving

Select this option to exit the Setup utility without saving the changes you have made in this session. Typing "Y" will quit the Setup utility without saving the modifications. Typing "N" will return you to Setup utility.

ROM PCI/ISA BIOS  
CMOS SETUP UTILITY  
AWARD SOFTWARE, INC.

STANDARD CMOS SETUP	INTEGRATED PERIPHERALS
BIOS FEATURES SETUP	SUPERVISOR PASSWORD
CHIPSET FEATURES SETUP	USER PASSWORD
POWER MANAGE	DETECTION
PNP/PCI CONF	FORMAT
LOAD BIOS DEF	UP
LOAD SETUP DEFAULTS	EXIT WITHOUT SAVING
ESC : Quit	↑ ↓ → ← : Select Item
F10 : Save & Exit Setup	(Shift) F2 : Change Color
Abandon all Data & Exit Setup	



## Chapter 7 LANDesk User's Guide

This chapter gives a brief introduction to the optional LANDesk® Client Manager (LDCM) utility, as well as the installation procedures. The following items are covered in this chapter:

7.1 Introduction .....	54
7.2 Installation .....	55
7.2.1 Installing the Local Version of LDCM	
7.2.2 Installing the Administrative Version of LDCM	

LANDesk is a registered trademark of Intel Corporation.

## **7.1 Introduction**

LANDesk Client Manager (LDCM 3.1 ) provides the capability for managing components (network interface cards, memory, printers, software applications, etc.) within a PC system. It uses the Desktop Management Interface (DMI) standard established by the Desktop Management Task Force (DMTF). Manageable components can be viewed, monitored, and administrated across multiple platforms, either locally or remotely on a network.

The LDCM package has been implemented in two different ways: a user (client/local) version and an administrative version (Remote Companion). The user version provides the ability to only manage the local PC. The administrative version allows a network administrator to manage the local PC and other PC nodes on the network. This means that the administrative version has the ability to gather information about remote PCs, as well as remotely controlling the PCs. The remote access is based upon granted rights by the managed client.

LDCM provides the user with self-help diagnostics, including a PC health meter, local alerting of potential problems, and hardware and software inventory. Automatic polling and alerting of memory and hardware conditions and predictive failure mechanisms minimize downtime and increase effective troubleshooting. LDCM can take periodic "snapshots" of critical configuration files for easy change management and restoration when needed.

To use LDCM, your computer must meet the following requirements:

- Operating System: Windows 95, Windows NT 3.51, or Windows NT4.0
- Memory: about 200KB
- Disk Storage Space: 3-5MB
- Hardware System: a DMI BIOS is required for full LDCM functionality

For network computers, the following requirements also apply:

- Protocols: IPX or IP (WinSock-enabled) communication protocol loaded on the client
- Hardware Interfaces: a network card for communication on the network

## 7.2 Installation

The optional LANdesk utility that comes with the CPU card runs in Windows NT or Windows 95 operating system.

Upon entering the Windows NT 4.0 or Windows 95 environment, insert the CD. Windows will autorun the installation program and show the following screen.

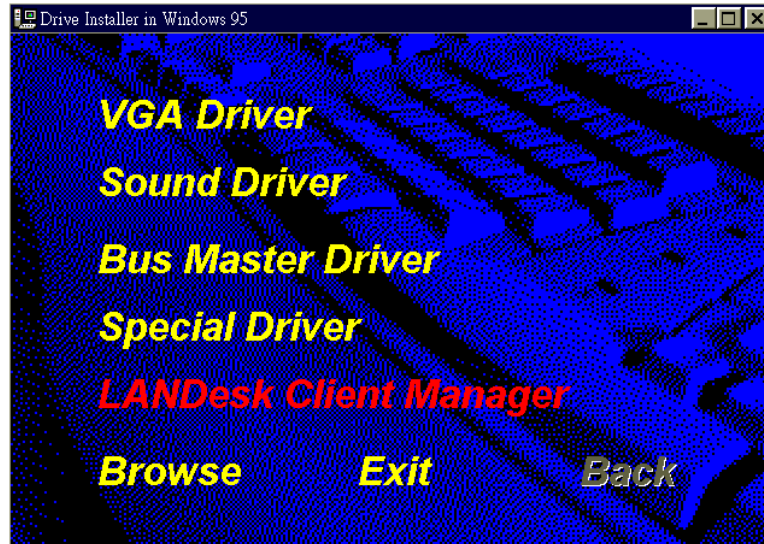

**NOTE:** During Setup, you will be asked to install Internet Explorer 3.02 in order to continue, or else Setup will be aborted. LDCM supports various languages and will default to English if it is unable to load 'language.dl'..

### 7.2.1 Installing the Local Version of LDCM

Double Click on 'LANDesk Client Manager' in the initial screen and the following screen will appear. Double click on the local version of LANDesk Client Manager.



When the Welcome screen appears, click on "Next" to continue with Setup.

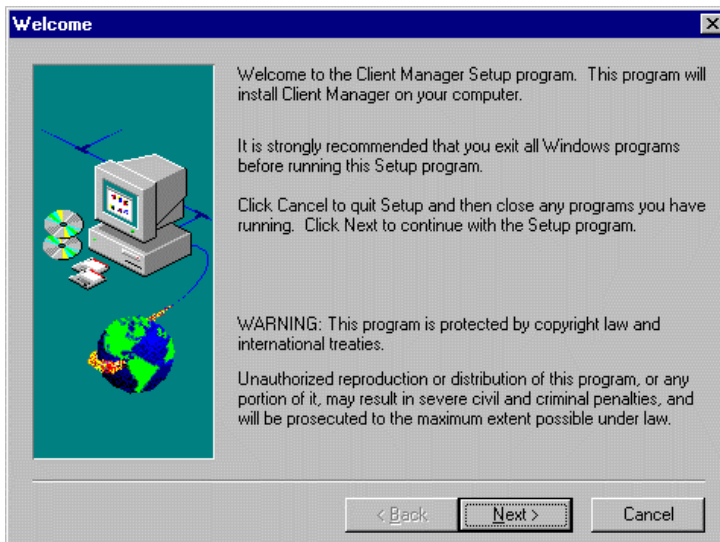

Choose the directory location where Setup will install LANdesk Client Manager. Click "Browse" if you want to change the directory suggested. Otherwise, click "Next" to start installing LDCM.

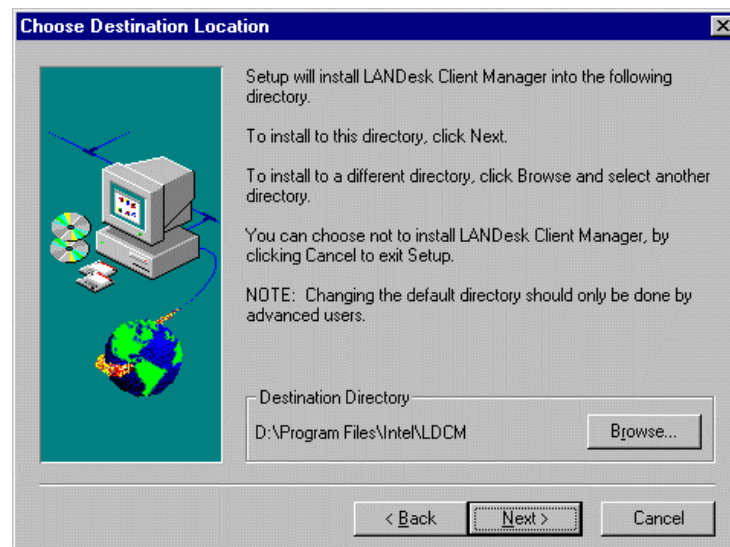

When Setup is finished, changes will have been made to the file AUTOEXEC.BAT. Restart your computer for the changes to take effect.

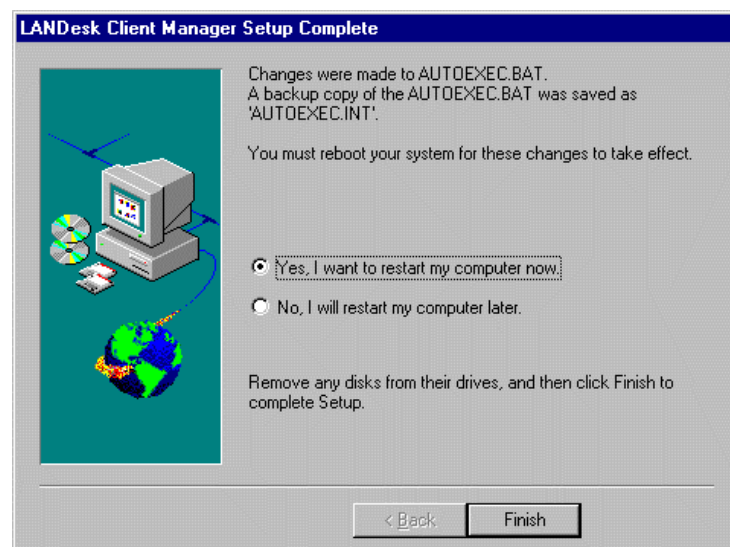

### 7.2.2 Installing the Administrative Version of LDCM

After double clicking on 'LANdesk Client Manager' in the initial screen, select the administrative version of the LDCM and the Welcome screen below will appear. Click on "Next" to continue.

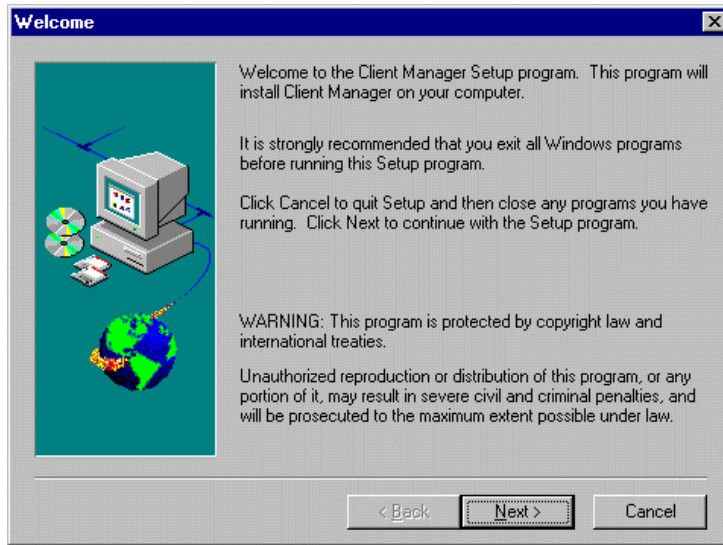

The screen below allows you to install the documentation in Adobe Acrobat format and the Adobe Acrobat Reader software. Select the options you need and click on "Next" to start the installation.

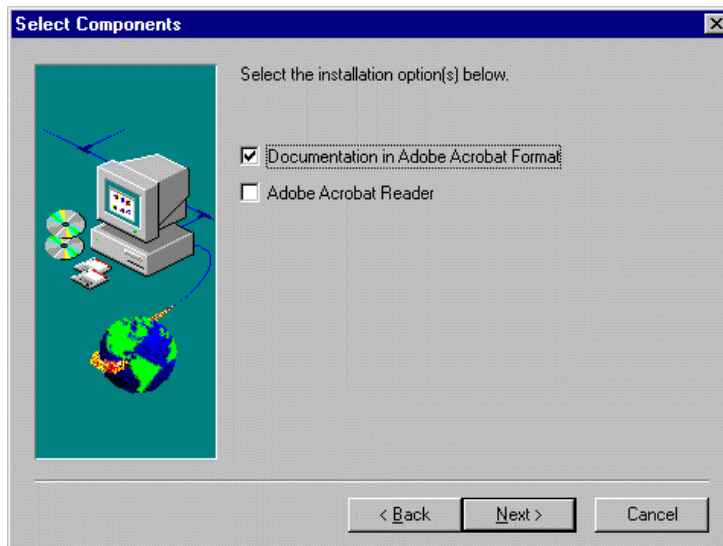

After LANdesk Client Manager Setup is complete, restart your computer to be able to use the LANdesk Client Manager.

