

FI7WBM SERIES
Socket 370 Intel 810DC-100/810E
Flex ATX Motherboard

User's Manual

Version 1.1A

Copyright Notice

This publication is protected by copyright and all rights are reserved. No part of it may be reproduced or transmitted by any means or in any form, without prior consent of the original manufacturer.

The information in this document has been carefully checked and is believed to be accurate. However, the original manufacturer assumes no responsibility for any inaccuracies that may appear in this manual. In no event will the original manufacturer be liable for direct, indirect, special, exemplary, incidental, incidental or consequential damages resulting from any defect or omission in this manual, even if advised of possibility of such damages. The material contained herein is for informational purposes only.

Acknowledgments

Award is a registered trademark of Award Software International, Inc.
PS/2 is a trademark of International Business Machines Corporation.
Intel and Celeron are registered trademarks of Intel Corporation.
Microsoft Windows is a registered trademark of Microsoft Corporation.
All other product names or trademarks are properties of their respective owners.

Contents

Chapter 1 Introduction.....	1
Chapter 2 Specifications.....	3
Chapter 3 Hardware Description.....	5
3.1 Processor.....	6
3.2 L2 Cache.....	6
3.3 Main Memory.....	6
3.4 BIOS.....	6
3.5 Onboard VGA.....	7
3.6 Hardware Monitoring.....	7
3.7 Onboard Multi-I/O.....	7
3.8 Onboard PCI-IDE.....	7
3.9 DMA Channels.....	7
3.10 Interrupt Request (IRQ) Lines.....	8
3.11 Onboard Audio.....	8
Chapter 4 Configuring the Motherboard.....	9
4.1 CPU Frequency Setting.....	11
4.2 JP4: Onboard Audio Enable/Disable.....	11
4.3 JP9: Boot Block Lock/Unlock.....	11
4.4 JP12: CPU Select(Iniel/Cyrix).....	12
4.5 JP14: Clear CMOS Select.....	12
4.6 JP15, JP16: CPU FSB for Cyrix CPU.....	12
4.7 JP17: Manufacturer Test Jumper.....	13
4.8 JP18: Vcore Output Range Select.....	13
4.9 5VSB and VCC LEDs.....	13
Chapter 5 Installation.....	15
5.1 I/O Connectors.....	17
5.2 JP1: PS/2 Keyboard and PS/2 Mouse Connectors.....	17
5.3 J1: RJ45 and USB Connectors.....	18
5.4 CON1: VGA Port Connector.....	18
5.5 CON2, CON4: Serial Port Connectors.....	19
5.6 J2: Parallel Port Connector.....	19
5.7 JP2, JP3: CD-ROM Audio In Connectors.....	20

5.8 J3: Line Out, Line In, Mic In, Game Port Connector	20
5.9 CON3: Audio Pin-header Connector	20
5.10 J4: Front Bezel Connectors	21
5.11 J5: ATX Power Supply Connector	23
5.12 F5: CPU Fan Power Connector	23
5.13 JP5: Wake on LAN Connector	23
5.14 F7: Chassis Fan Power Connector	24
5.15 CON7: USB2/3 Pin-header Connector	24
5.16 CON8, CON6: IrDA Connectors	24
5.17 FDC: Floppy Drive Connector	25
5.18 JP20 (IDE1), JP19 (IDE2): EIDE Connectors	26
Chapter 6 BIOS Configuration.....	27
6.1 BIOS Introduction	28
6.2 BIOS Setup	28
6.3 Standard CMOS Setup.....	30
6.4 Advanced BIOS Features	33
6.5 Advanced Chipset Features	36
6.6 Integrated Peripherals	38
6.7 Power Management Setup	41
6.8 PNP/PCI Configurations.....	44
6.9 PC Health Status	45
6.10 Frequency/Voltage Control.....	46
6.11 Load Fail-Safe Defaults	47
6.12 Load Setup Defaults	47
6.13 Set Supervisor/User Password	48
6.14 Save & Exit Setup.....	49
6.15 Exit Without Saving	49
Chapter 7 Intel 810 DC-100/810E Drivers Installation...	51
.....	
Installing Intel 82810 DC-100/810E Define Drivers for Windows.....	
95/98	52
Installing Intel 82810 DC-100/810E VGA Driver for Windows 95/98	
.....	55
Installing Intel 82810 DC-100/810E VGA Driver for Windows NT...	
.....	58
Installing Intel 82810 DC-100/810E Audio Driver for Windows	
95/98/NT.....	60
Appendix	62

Chapter 1 Introduction

This manual is designed to give you information on the FI7WBM motherboard. It is divided into the following sections:

- **Introduction**
- **Specifications**
- **Hardware Description**
- **Configuring the Motherboard**
- **Installation**
- **BIOS Configuration**
- **Intel 810DC-100/810E Drivers Installation**

Checklist

Please check that your package is complete and contains the items below. If you discover damaged or missing items, please contact your dealer.

- The FI7WBM Motherboard
- 1 IDE ribbon cable with UDMA66 support
- 1 floppy ribbon cable



The ATA-66 IDE cable is used in conjunction with Ultra DMA/66 hard disks. Refer to the figure below on how to connect the cable.

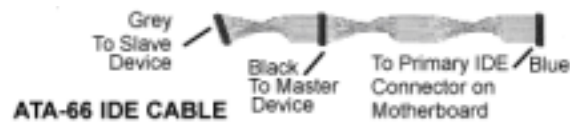

This page was intentionally left blank

Chapter 2 Specifications

The FI7WBM is a high-performance Flex Intel 810DC-100/810E motherboard with a Socket 370 connector for Intel Celeron/Coppermine and Cyrix Joshua processors. The motherboard offers flexibility in terms of CPU frequency and main memory type and size. The main features of the motherboard consist of the following:

CPU Socket

Socket 370

Chipset

Intel 810 (DC-100) / 810E

Processor

Intel Celeron / Coppermine

Cyrix Joshua

300MHz ~ 1GHz or higher when available

Bus Speed

66/100MHz for 810 (DC-100) chipset

66/100/133MHz for 810E chipset

L2 Cache

CPU integrated L2 cache (128Kb or 256Kb)

Main Memory

Two 168-pin DIMM sockets

Memory types: SDRAM (Synchronous DRAM)

Memory module sizes: 16MB, 32MB, 64MB, 128MB, 256MB, 512MB

Chipset

Intel 82801AA chipset with built-in PCI-IDE

Super I/O

Built-in Winbond 83627HF chip

- Two 16550 UART compatible serial ports
- One parallel port (ECP/EPP compatible)
- One floppy controller (2.88MB compatible)
- One IrDA port

PCI Bus Master IDE Controller

The onboard chipset's PCI Bus Master IDE controller with two connectors for up to four IDE devices in two channels, supporting enhanced IDE devices such as tape backup and CD-ROM drives, PIO Mode 3/4 and Bus Mastering Ultra DMA/66 / Ultra DMA/33.

Note: A UDMA66 cable should be used for UDMA66 interface. Under Windows NT 4.0, you need to install Windows NT Service Pack 5.)

BIOS

Award BIOS with ISA Plug and Play (PnP) extension, DMI, bootable CD-ROM and power-management features. The BIOS is Y2K (Year 2000) compliant.

Mouse Connector

PS/2 type

Keyboard Connector

PS/2 type

USB Connector

2 ports on board or pin header supporting 2 USB ports

Win95/98 shut-off

Allows shut-off control from within Windows 95/98

Onboard Audio

Onboard AC97 Codec with external connectors for Line out, Line in, Mic and Game port

Onboard VGA

The highly integrated graphics accelerator consists of dedicated multimedia engines executing in parallel to deliver high performance 3D, 2D and motion compensation video capabilities. The 3D and 2D engines are managed by a 3D/2D pipeline preprocessor allowing a sustained flow of graphics data to be rendered and displayed. It also features a 4MB display cache buffer.

Expansion Slots

One 32-bit PCI slots
One AMR slot for modem

Form Factor

Flex, 9" x 7.48" (22.8cm x 19cm)

Chapter 3 Hardware Description

This chapter briefly describes each of the major features of the FI7WBM motherboard. The layout of the board in Figure 1 shows the location of the key components. The topics covered in this chapter are as follows:

3.1 Processor	6
3.2 L2 Cache	6
3.3 Main Memory.....	6
3.4 BIOS.....	6
3.5 Onboard VGA	7
3.6 Hardware Monitoring	7
3.7 Onboard Multi-I/O	7
3.8 Onboard PCI-IDE.....	7
3.9 DMA Channels.....	7
3.10 Interrupt Request (IRQ) Lines.....	8
3.11 Onboard Audio	8

3.1 Processor

The FI7WBM motherboard is designed to take an Intel Celeron/Coppermine or Cyrix Joshua (ver. 2.4 and above) processor running 300~1GHz or higher when available.

3.2 L2 Cache

The L2 cache (128Kb or 256Kb) is integrated in the processor.

3.3 Main Memory

The FI7WBM motherboard supports two 168-pin DIMM (Dual In-line Memory Module) sockets to form a memory configuration from 32MB to 512MB. Refer to the following table on how to do the memory configuration.

(DIMM1)	(DIMM2)	Total Memory
16MB	16MB	32MB
32MB	-----	32MB
64MB	-----	64MB
128MB	-----	128MB
256MB	-----	256MB
32MB	32MB	64MB
64MB	64MB	128MB
128MB	64MB	192MB
128MB	128MB	256MB
256MB	256MB	512MB



- To run Windows NT 4.0, you need at least 64MB of total memory.
- This is not an exhaustive list of possible combinations.
- Use SDRAM modules with PC100 specification only when running either 66MHz or 100MHz CPU bus speed.

3.4 BIOS

The BIOS on the FI7WBM motherboard provides the standard BIOS functions plus the following feature:

Power Management

The power management feature provides power savings by slowing down the CPU clock, turning off the monitor screen and stopping the HDD spindle motor. The BIOS fully conforms to ACPI (Advanced Configuration and Power Interface) specification.

3.5 Onboard VGA

The highly integrated graphics accelerator consists of dedicated multimedia engines executing in parallel to deliver high performance 3D, 2D and motion compensation video capabilities. The 3D and 2D engines are managed by a 3D/2D pipeline preprocessor allowing a sustained flow of graphics data to be rendered and displayed.

3.6 Hardware Monitoring

The Winbond 83627HFchip has a built-in hardware status monitoring function that monitor several hardware parameters including power supply voltages, fan speeds, and temperatures, which are very important for a high-end computer system to work stable and properly. This function is used together with System Monitor utility or the optional Intel LANDesk Client Manager utility.

3.7 Onboard Multi-I/O

The multi-I/O function is built in the Winbond 83627HF chip supports a keyboard controller, two serial ports, one parallel port, one floppy controller and one IrDA port. The serial ports are 16550 UART compatible. The parallel port features high-speed EPP/ECP mode. The floppy controller supports up to 2.88MB format.

3.8 Onboard PCI-IDE

The Intel 810DC-100/810E chipset's built-in's PCI-IDE controller supports PIO mode 3/4 and bus mastering Ultra DMA/66 / Ultra DMA/33. The peak transfer rate of PIO mode 3/4 can be as high as 17MB/sec. Using HDDs that support Ultra DMA/66, the peak transfer rate can reach 66MB/sec.

3.9 DMA Channels

There are seven DMA channels available on the motherboard; only DMA2 is used by the floppy controller. In the case that ECP mode on the parallel port is utilized, DMA1 or DMA3 will be used.

3.10 Interrupt Request (IRQ) Lines

There are a total of 15 IRQ lines available on the motherboard. Peripheral devices use an interrupt request to notify the CPU for the service required. The following table shows the IRQ lines used by the devices on the motherboard:

<u>Level</u>	<u>Function</u>
IRQ0	System Timer Output
IRQ1	Keyboard
IRQ2	Interrupt Cascade
IRQ8	Real Time Clock
IRQ9	Software Redirected to Int 0Ah
IRQ10	Reserved
IRQ11	Reserved
IRQ12	Reserved
IRQ13	Co-Processor
IRQ14	Primary IDE
IRQ15	Secondary IDE
IRQ3	INTERRUPT
IRQ4	Serial Port #1
IRQ5	INTERRUPT
IRQ6	Floppy Disk Controller
IRQ7	Parallel Port #1

3.11 Onboard Audio



With the integrated AC'97 Codec Chip combined with the AC'97 link controller, AC-97 Audio provides cost-effective solution for delivering high-quality audio capabilities. Connectors available are three Audio jacks including Line In, Line Out and Mic In and One Game Port

Chapter 4 Configuring the Motherboard

The following sections describe the necessary procedures and proper jumper settings to configure the FI7WBM motherboard. For the locations of the jumpers, refer to Figure 2.

4.1 CPU Frequency Setting	11
4.2 JP4: Onboard Audio Enable/Disable	11
4.3 JP9: Boot Block Lock/Unlock	11
4.4 JP12: CPU Select(Intel/Cyrix)	12
4.5 JP14: Clear CMOS Select12	12
4.6 JP15, JP16: CPU FSB for Cyrix CPU	12
4.7 JP17: Manufacturer Test Jumper	13
4.8 JP18: Vcore Output Range Select	13
4.9 5VSB and VCC LEDs	13

The following examples show the conventions used in this chapter.

	Jumper Open
	Jumper Closed/Short

4.1 CPU Frequency Setting

The FI7WBM uses jumper-free technology in configuring the processor on the motherboard. The system automatically detects the CPU bus speed, 66MHz 100MHz, or 133MHz and sets the multiplier, or ratio, to 3X. However, the bus speed can also be configured through the BIOS if the processor supports this feature. The BIOS (under CPU Features Setup) allows users to change the CPU bus speed multiplier (3X, 3.5X, 4X, 4.5X, 5X, 5.5X, 6X, 6.5X, 7X, 7.5X, 8X) to set the correct or desired CPU frequency. *The CPU bus speed multiplier will remain unchanged if the CPU installed supports a fixed (only one) bus speed multiplier.*



It is possible that the system will not boot if the CPU has been changed. When this happens, turn off the computer by pressing the power button and turn it on again by pressing the Insert key and the power button simultaneously. *(Note to press the Insert key until an image appears on the screen.)* When the system is turned on, press the Delete key to enter BIOS Setup and configure the CPU speed.

4.2 JP4: Onboard Audio Enable/Disable

JP4	Jumper Setting	Function
<p>1 2 3</p>	pin 1-2: short	Onboard Audio Disabled
<p>1 2 3</p>	pin 2-3: short	Onboard Audio Enabled

4.3 JP9: Boot Block Lock/Unlock

When the Boot Block is locked, BIOS flash update cannot be executed.

JP9	Function	JP9	Function
<p>SHORT</p>	Boot Block Unlock	<p>OPEN</p>	Boot Block Locked

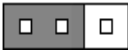

4.4 JP12: CPU Select(Intel/ Cyrix)

The JP12 3-pin jumper is used in conjunction with the processor installed on the motherboard whether it is an Intel or Cyrix processor. Refer to the table below.

JP12	Function	JP12	Function
 1 2 3	Intel CPU (Default)	 1 2 3	Cyrix CPU

4.5 JP14: Clear CMOS Select

Use JP14, a 3-pin header, to clear the contents of the CMOS RAM. Do not clear the CMOS RAM unless it is absolutely necessary. You will lose your password, etc.







JP14	Jumper Setting	Function
 1 2 3	pin 1-2: short	Clear CMOS
 1 2 3	pin 2-3: short	Normal

Follow the steps below to clear CMOS data.

1. Disconnect the AC power cord.
2. Short JP12 (1-2) and wait for 3 seconds.
3. Short JP12 (2-3) and replace the AC power cord.
4. Turn on the system.

4.6 JP15, JP16: CPU FSB for Cyrix CPU

When using an Intel CPU, JP15 and JP16 should be left open. Please refer to the table below when using Cyrix CPU.



JP15	JP16	FSB
 SHORT	 SHORT	66MHz
 OPEN	 SHORT	100MHz
 OPEN	 OPEN	133MHz

4.7 JP17: Manufacturer Test Jumper

The JP17 10-pin jumper is manufacturer test jumper for measuring voltages and should be left to its default of open.

4.8 JP18: Vcore Output Range Select

The 2-pin JP18 jumper is configuring the Vcore Output.

JP18	Function	JP18	Function
 SHORT	Intel CPU Vid0~Vid3 Vcore Range: 2.05V~1.35V	 OPEN	Cyrix CPU Vid0~Vid3 Vcore Range: 3.45V~1.35V

4.9 5VSB and VCC LEDs

The 5VSB LED light is on to indicate that there is suspend power signal from the power supply . The VCC LED light is on to indicate the power is on.

This page was intentionally left blank

Chapter 5 Installation

This chapter describes the interface that the FI7WBM provides for creating a working system. Refer to Figure 3 for the location of the connectors.

The following items are covered in this chapter:

5.1 I/O Connectors	17
5.2 JP1: PS/2 Keyboard and PS/2 Mouse Connectors.....	17
5.3 J1: RJ45 and USB Connectors	18
5.4 CON1: VGA Port Connector.....	18
5.5 CON2, CON4: Serial Port Connectors	19
5.6 J2: Parallel Port Connector.....	19
5.7 JP2, JP3: CD-ROM Audio In Connectors	20
5.8 J3: Line Out, Line In, Mic In, Game Port	20
5.9 CON3: Audio Pin-header Connector.....	20
5.10 J4 Front Bezel Connectors.....	21
5.11 J5: ATX Power Supply Connector	23
5.12 F5: CPU Fan Power Connector	23
5.13 JP5: Wake on LAN Connector	23
5.14 F7: Chassis Fan Power Connector.....	24
5.15 CON7: USB2/3 Pin-header Connector.....	24
5.16 CON8, CON6: IrDA Connectors.....	24
5.17 FDC: Floppy Drive Connector	25
5.18 JP20 (IDE1), JP19 (IDE2): EIDE Connectors.....	26

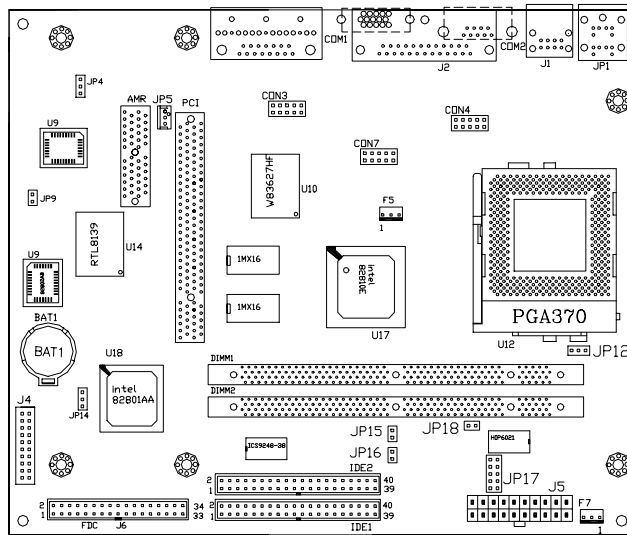

Figure 3: Connector Location on the FI7WBM

- JP1: PS/2 Keyboard and PS/2 Mouse Connectors
- J1: USB and RJ45 Connectors
- CON1: VGA Port Connector
- CON2, CON4: Serial Port Connectors
- J2: Parallel Port Connector
- JP2, JP3: CD-ROM Audio In Connectors
- J3: Line Out, Line In, Mic In, Game Port
- CON3: Audio Pin-header Connector
- J4 Front Bezel Connectors
- J5: ATX Power Supply Connector
- F5: CPU Fan Power Connector
- F7: Chassis Fan Power Connector
- CON7: USB2/3 Pin-header Connector
- CON8, CON6: IrDA Connectors
- FDC: Floppy Drive Connector
- JP20 (IDE1), JP19 (IDE2): EIDE Connectors

5.1 I/O Connectors

The I/O connectors connect the FI7WBM to the most common peripherals. To attach cables to these connectors, carefully align Pin 1 of the cables to that of the connectors. Refer to Figure 4 for the location and orientation of the connectors.

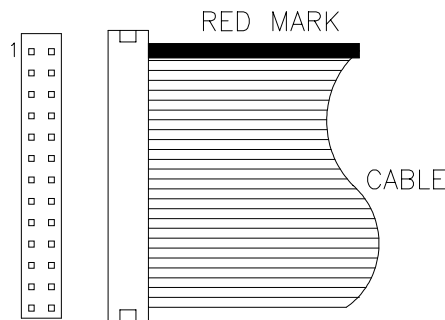
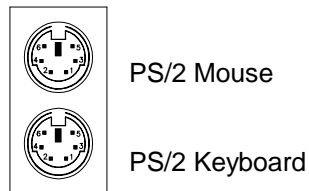

Figure 4: Orientation of the I/O Connector

5.2 JP1: PS/2 Keyboard and PS/2 Mouse Connectors



Below are the pin-out assignments of the connectors.

Signal Name	Keyboard	Mouse	Signal Name
Keyboard data	1	1	Mouse data
N.C.	2	2	N.C.
GND	3	3	GND
5V	4	4	5V
Keyboard clock	5	5	Mouse clock
N.C.	6	6	N.C.

5.3 J1: RJ45 and USB Connectors

J1 consists of an RJ-45 connector on top and two stacked USB ports at the bottom. The RJ-45 Ethernet connector supports 10/100Mbps data transfer rates. USB support allows connections of up to 64 plug and play external peripherals per channel.

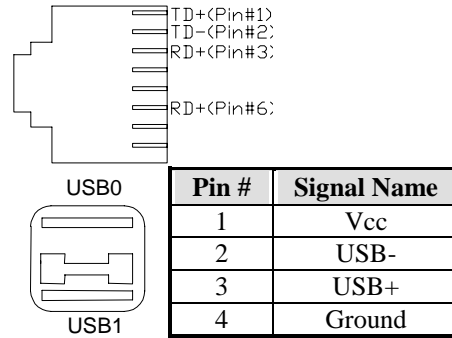

5.4 CON1: VGA Port Connector

CON1 is a DB-15 VGA connector. The following table shows the pin-out assignments of this connector.

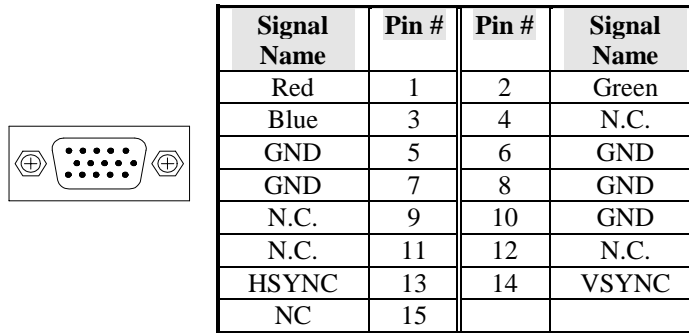

5.5 CON2, CON4: Serial Port Connectors

The onboard serial ports are CON2, a DB-9 connector which is COM1 and CON4, a 10-pin header connector which is COM2. The following table shows the pin-out assignments of these connectors.

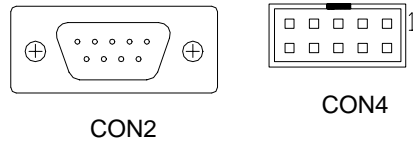

Signal Name	Pin #	Pin #	Signal Name
DCD, Data carrier detect	1	6	DSR, Data set ready
RXD, Receive data	2	7	RTS, Request to send
TXD, Transmit data	3	8	CTS, Clear to send
DTR, Data terminal ready	4	9	RI, Ring indicator
GND, ground	5	10	Not Used

5.6 J2: Parallel Port Connector

J2 is a DB-25 external connector as seen in the previous figure. The following table describes the pin-out assignments of this connector.

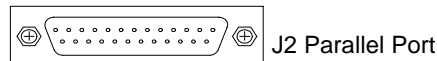

Signal Name	Pin #	Pin #	Signal Name
Line printer strobe	1	14	AutoFeed
PD0, parallel data 0	2	15	Error
PD1, parallel data 1	3	16	Initialize
PD2, parallel data 2	4	17	Select
PD3, parallel data 3	5	18	Ground
PD4, parallel data 4	6	19	Ground
PD5, parallel data 5	7	20	Ground
PD6, parallel data 6	8	21	Ground
PD7, parallel data 7	9	22	Ground
ACK, acknowledge	10	23	Ground
Busy	11	24	Ground
Paper empty	12	25	Ground
Select	13	N/A	N/A

5.7 JP2, JP3: CD-ROM Audio In Connectors

JP2 and JP3 are the onboard CD-ROM audio in connectors. Below are their pin assignments.



Signal Name	Pin #	Pin #	Signal Name
Left	1	1	Ground
Ground	2	2	Left
Ground	3	3	Ground
Right	4	4	Right

5.8 J3: Line Out, Line In, Mic In, Game Port

J3 is the connector consisting of audio line out, audio line in, microphone and game port.

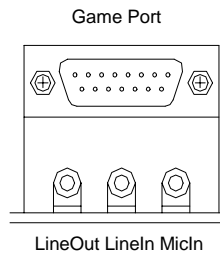

5.9 CON3: Front Plane Line Out/Line In/Mic Connector

J3 is 10-pin header jumper that is used for extra audio connectors (Line In, Line Out, Mic), apart from those external connectors built in on the motherboard. Refer to the pin assignment on the table below.



Signal Name	Pin #	Pin #	Signal Name
Line_Out_L	1	2	Line_Out_R
Ground	3	4	Ground
Line_In_L	5	6	Line_In_R
Ground	7	8	Precaution Pin
Mic_In	9	10	MIC_VREF

5.10 J4: Front Bezel Connectors

The front bezel of the case has a control panel which provides light indication of the computer activities and switches to change the computer status. CN8 is a 20-pin header that provides interfaces for the following functions.

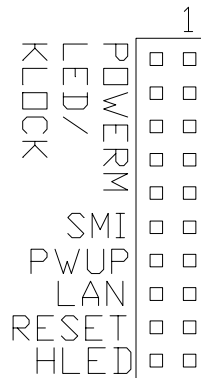

Speaker: Pins 1 - 4

This connector provides an interface to a speaker for audio tone generation. An 8-ohm speaker is recommended.

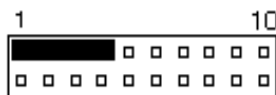

Pin #	Signal Name
1	Speaker out
2	No connect
3	Ground
4	+5V

Power LED: Pins 11 - 15

The power LED indicates the status of the main power switch.



Pin #	Signal Name
11	Power LED
12	No connect
13	Ground
14	No connect
15	Ground

EXT SMI: Pins 6 and 16

This 2-pin connector is for the “Green Switch” on the control panel, which, when pressed, will force the system immediately into the power saving (sleep) mode.

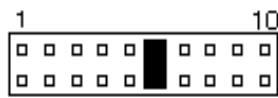

Pin #	Signal Name
6	Sleep
16	Ground

ATX Power ON Switch: Pins 7 and 17

This is an “ATX Power Supply On/Off Switch” that is connected to the power switch on the case.

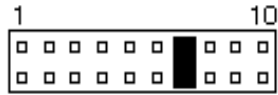

Pin #	Signal Name
7	5V
17	Ground

LAN: 8 and 18

This 2-pin connector is for the LAN LED.

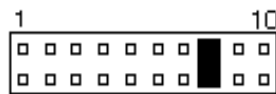

Reset Switch: Pins 9 and 19

The reset switch allows the user to reset the system without turning the main power switch off and then on again. Orientation is not required when making a connection to this header.

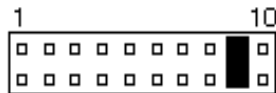

Hard Disk Drive LED Connector: Pins 10 and 20

This connector connects to the hard drive activity LED on control panel. This LED will flash when the HDD is being accessed.

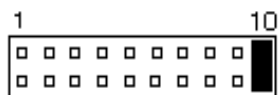

Pin #	Signal Name
10	HDD LED
20	5V

5.11 J5: ATX Power Supply Connector

J5 is a 20-pin ATX power supply connector. Refer to the following table for the pin out assignments.

Signal Name	Pin #	Pin #	Signal Name
3.3V	11	1	3.3V
-12V	12	2	3.3V
Ground	13	3	Ground
PS-ON	14	4	+5V
Ground	15	5	Ground
Ground	16	6	+5V
Ground	17	7	Ground
-5V	18	8	Power good
+5V	19	9	5VSB
+5V	20	10	+12V

5.12 F5: CPU Fan Power Connector

F5 CPU fan power connector is a 3-pin header supporting a 12V fan.

Pin #	Signal Name
1	Ground
2	+12V
3	Rotation

5.13 JP5: Wake on LAN Connector

JP5 is a 3-pin header for the Wake on LAN function. Wake on LAN will function properly only with an ATX power supply with 5VSB that has 200mA.

Pin #	Signal Name
1	+5VSB
2	Ground
3	Wake on LAN

5.14 F7: Chassis Fan Power Connector

The F7 chassis fan power connector is a 3-pin header for a 12V fan.

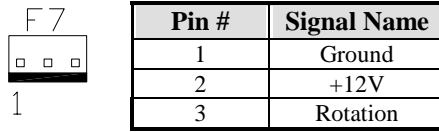

5.15 CON7: USB2/3 Pin-header Connector

CON7 is a 10-pin headers supporting two external USB ports. Below are the pin assignments of this connector.

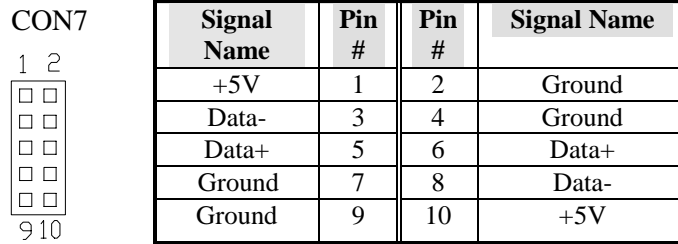

5.16 CON8, CON6: IrDA Connectors

There are two IrDA header-connectors on FI7SM that support infrared wireless communication. CON8 is used for the IrDA interface on the front side of the case while CON6 is for the backside IrDA interface.

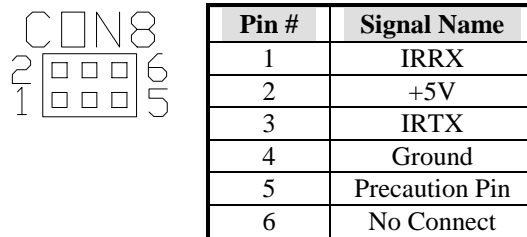

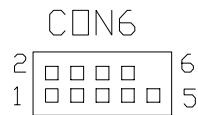

Signal Name	Pin #	Pin #	Signal Name
+5V	1	6	N.C.
N.C.	2	7	CIRRX
Ir RX	3	8	5VSB
Ground	4	9	N.C.
Ir TX	5		

5.17 FDC: Floppy Drive Connector

FDC of the FI7WBM is a 34-pin header and will support up to 2.88MB floppy drives. The following table shows its pin-out assignments.

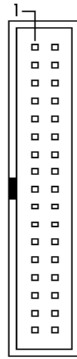

Signal Name	Pin #	Pin #	Signal Name
Ground	1	2	RM/LC
Ground	3	4	No connect
Ground	5	6	No connect
Ground	7	8	Index
Ground	9	10	Motor enable 0
Ground	11	12	Drive select 1
Ground	13	14	Drive select 0
Ground	15	16	Motor enable 1
Ground	17	18	Direction
Ground	19	20	Step
Ground	21	22	Write data
Ground	23	24	Write gate
Ground	25	26	Track 00
Ground	27	28	Write protect
Ground	29	30	Read data
Ground	31	32	Side 1 select
Ground	33	34	Diskette change

5.18 JP20 (IDE1), JP19 (IDE2): EIDE Connectors

JP20: Primary IDE Connector

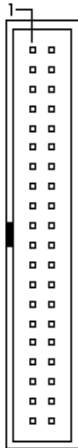

Signal Name	Pin #	Pin #	Signal Name
Reset IDE	1	2	Ground
Host data 7	3	4	Host data 8
Host data 6	5	6	Host data 9
Host data 5	7	8	Host data 10
Host data 4	9	10	Host data 11
Host data 3	11	12	Host data 12
Host data 2	13	14	Host data 13
Host data 1	15	16	Host data 14
Host data 0	17	18	Host data 15
Ground	19	20	Key
DRQ0	21	22	Ground
Host IOW	23	24	Ground
Host IOR	25	26	Ground
IOCHRDY	27	28	Host ALE
DACK0	29	30	Ground
IRQ14	31	32	No connect
Address 1	33	34	UDMA66 Enable
Address 0	35	36	Address 2
Chip select 0	37	38	Chip select 1
Activity	39	40	Ground

JP19: Secondary IDE Connector

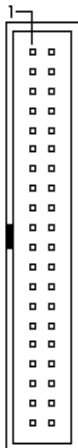

Signal Name	Pin #	Pin #	Signal Name
Reset IDE	1	2	Ground
Host data 7	3	4	Host data 8
Host data 6	5	6	Host data 9
Host data 5	7	8	Host data 10
Host data 4	9	10	Host data 11
Host data 3	11	12	Host data 12
Host data 2	13	14	Host data 13
Host data 1	15	16	Host data 14
Host data 0	17	18	Host data 15
Ground	19	20	Key
DRQ0	21	22	Ground
Host IOW	23	24	Ground
Host IOR	25	26	Ground
IOCHRDY	27	28	Host ALE
DACK1	29	30	Ground
MIRQ0	31	32	No connect
Address 1	33	34	UDMA66 Enable
Address 0	35	36	Address 2
Chip select 0	37	38	Chip select 1
Activity	39	40	Ground

Chapter 6 BIOS Configuration

This chapter describes the different settings available in the Award BIOS. The topics covered in this chapter are as follows:

6.1 BIOS Introduction	28
6.2 BIOS Setup.....	28
6.3 Standard CMOS Setup	30
6.4 Advanced BIOS Features	33
6.5 Advanced Chipset Features	36
6.6 Integrated Peripherals.....	38
6.7 Power Management Setup.....	41
6.8 PNP/PCI Configurations	44
6.9 PC Health Status.....	45
6.10 Frequency/Voltage Control	46
6.11 Load Fail-Safe Defaults.....	47
6.12 Load Setup Defaults	47
6.13 Set Supervisor/User Password.....	48
6.14 Save & Exit Setup	49
6.15 Exit Without Saving	49

6.1 BIOS Introduction

The Award BIOS (Basic Input/Output System) installed in your computer system's ROM supports Socket 370 processors. The BIOS provides critical low-level support for a standard device such as disk drives, serial and parallel ports. It also adds virus and password protection as well as special support for detailed fine-tuning of the chipset controlling the entire system.

6.2 BIOS Setup

The Award BIOS provides a Setup utility program for specifying the system configurations and settings. The BIOS ROM of the system stores the Setup utility. When you turn on the computer, the Award BIOS is immediately activated. Pressing the key immediately allows you to enter the Setup utility. If you are a little bit late pressing the key, POST (Power On Self Test) will continue with its test routines, thus preventing you from invoking the Setup. If you still wish to enter Setup, restart the system by pressing the "Reset" button or simultaneously pressing the <Ctrl>, <Alt> and <Delete> keys. You can also restart by turning the system Off and back On again. The following message will appear on the screen:

Press to Enter Setup

In general, you press the arrow keys to highlight items, <Enter> to select, the <PgUp> and <PgDn> keys to change entries, <F1> for help and <Esc> to quit.

When you enter the Setup utility, the Main Menu screen will appear on the screen. The Main Menu allows you to select from various setup functions and exit choices.

CMOS Setup Utility – Copyright © 1984-1999 Award Software

Standard CMOS Features	Frequency/Voltage Control
Advanced BIOS Features	Load Fail-Safe Defaults
Advanced Chipset Features	Load Optimized Defaults
Integrated Peripherals	Set Supervisor Password
Power Management Setup	Set User Password
PnP/PCI Configurations	Save & Exit Setup
PC Health Status	Exit Without Saving
ESC : Quit	↑ ↓ → ← : Select Item
F10 : Save & Exit Setup	
Time, Date, Hard Disk Type...	

The section below the setup items of the Main Menu displays the control keys for this menu. At the bottom of the Main Menu just below the control keys section, there is another section which displays information on the currently highlighted item in the list.

NOTE: If your computer cannot boot after making and saving system changes with Setup, the Award BIOS supports an override to the CMOS settings that resets your system to its default.

We strongly recommend that you avoid making any changes to the chipset defaults. These defaults have been carefully chosen by both Award and your system manufacturer to provide the absolute maximum performance and reliability.

6.3 Standard CMOS Setup

“Standard CMOS Setup” choice allows you to record some basic hardware configurations in your computer system and set the system clock and error handling. If the motherboard is already installed in a working system, you will not need to select this option. You will need to run the Standard CMOS option, however, if you change your system hardware configurations, the onboard battery fails, or the configuration stored in the CMOS memory was lost or damaged.

CMOS Setup Utility – Copyright © 1984-1999 Award Software
Standard CMOS Features

Date (mm:dd:yy)	Tue, Mar 26 1999	Item Help
Time (hh:mm:ss)	00 : 00 : 00	Menu Level
IDE Primary Master	Press Enter 13020 MB	Change the day, month, Year and century
IDE Primary Slave	Press Enter None	
IDE Secondary Master	Press Enter None	
IDE Secondary Slave	Press Enter None	
Drive A	1.44M, 3.5 in.	
Drive B	None	
Video	EGA/VGA	
Halt On	All Errors	
Base Memory	640K	
Extended Memory	129024K	
Total Memory	130048K	

At the bottom of the menu are the control keys for use on this menu. If you need any help in each item field, you can press the <F1> key. It will display the relevant information to help you. The memory display at the lower right-hand side of the menu is read-only. It will adjust automatically according to the memory changed. The following describes each item of this menu.

Date

The date format is:

Day : Sun to Sat
Month : 1 to 12
Date : 1 to 31
Year : 1994 to 2079

To set the date, highlight the “Date” field and use the PageUp/PageDown or +/- keys to set the current time.

Time

The time format is: **Hour : 00 to 23**
Minute : 00 to 59
Second : 00 to 59

To set the time, highlight the “Time” field and use the <PgUp>/<PgDn> or +/- keys to set the current time.

IDE Primary HDDs / IDE Secondary HDDs

The onboard PCI IDE connectors provide Primary and Secondary channels for connecting up to four IDE hard disks or other IDE devices. Each channel can support up to two hard disks; the first is the “Master” and the second is the “Slave”.

Press <Enter> to configure the hard disk. The selections include Auto, Manual, and None. Select ‘Manual’ to define the drive information manually. You will be asked to enter the following items.

CYLS : Number of cylinders
HEAD : Number of read/write heads
PRECOMP : Write precompensation
LANDZ : Landing zone
SECTOR : Number of sectors

The Access Mode selections are as follows:

Auto
Normal (HD < 528MB)
Large (for MS-DOS only)
LBA (HD > 528MB and supports
Logical Block Addressing)

Drive A / Drive B

These fields identify the types of floppy disk drive A or drive B that has been installed in the computer. The available specifications are:

360KB 1.2MB 720KB 1.44MB 2.88MB
5.25 in. 5.25 in. 3.5 in. 3.5 in. 3.5 in.

Video

This field selects the type of video display card installed in your system.

You can choose the following video display cards:

EGA/VGA	For EGA, VGA, SEGA, SVGA or PGA monitor adapters. (default)
CGA 40	Power up in 40 column mode.
CGA 80	Power up in 80 column mode.
MONO	For Hercules or MDA adapters.

Halt On

This field determines whether or not the system will halt if an error is detected during power up.

No errors	The system boot will not be halted for any error that may be detected.
All errors	Whenever the BIOS detects a non-fatal error, the system will stop and you will be prompted.
All, But Keyboard	The system boot will not be halted for a keyboard error; it will stop for all other errors
All, But Diskette	The system boot will not be halted for a disk error; it will stop for all other errors.
All, But Disk/Key	The system boot will not be halted for a keyboard or disk error; it will stop for all others.

6.4 Advanced BIOS Features

This section allows you to configure and improve your system and allows you to set up some system features according to your preference.

CMOS Setup Utility – Copyright © 1984-1999 Award Software
Advanced BIOS Features

		ITEM HELP
Virus Warning	Disabled	Menu Level
CPU Internal Cache	Enabled	
External Cache	Enabled	
CPU L2 Cache ECC Checking	Enabled	
Quick Power On Self Test	Enabled	
First Boot Device	Floppy	
Second Boot Device	HDD-0	
Third Boot Device	LS/ZIP	
Boot Other Device	Enabled	
Swap Floppy Drive	Disabled	
Boot Up Floppy Seek	Disabled	
Boot Up Numlock Status	On	
Gate A20 Option	Fast	
Typematic Rate Setting	Disabled	
Typematic Rate (chars/Sec)	6	
Typematic Delay (Msec)	250	
Security Option	Setup	
OS Select For DRAM>64MB	Non-OS2	
Report No FDD For WIN 95	Yes	
		Allows you choose the VIRUS warning feature for IDE Hard Disk boot sector protection. If this function is enabled and someone attempt to write data into this area, BIOS will show a warning message on screen and alarm beep

Virus Warning

This item protects the boot sector and partition table of your hard disk against accidental modifications. If an attempt is made, the BIOS will halt the system and display a warning message. If this occurs, you can either allow the operation to continue or run an anti-virus program to locate and remove the problem.

NOTE: Many disk diagnostic programs, which attempt to access the boot sector table, can cause the virus warning. If you will run such a program, disable the Virus Warning feature.

CPU Internal Cache / External Cache

Cache memory is additional memory that is much faster than conventional DRAM (system memory). CPUs from 486-type on up contain internal cache memory, and most, but not all, modern PCs have additional (external) cache memory. When the CPU requests data, the system transfers the requested data from the main DRAM into cache memory, for even faster access by the CPU. These items allow you to enable (speed up memory access) or disable the cache function. By default, these items are **Enabled**.

CPU L2 Cache ECC Checking

This field enables or disables the ECC (Error Correction Checking) checking of the CPU level-2 cache. The default setting is **Enabled**.

Quick Power On Self Test

When enabled, this field speeds up the Power On Self Test (POST) after the system is turned on. If it is set to *Enabled*, BIOS will skip some items.

First/Second/Third Boot Device

These fields determine the drive that the system searches first for an operating system. The options available include *Floppy*, *LS/ZIP*, *HDD-0*, *SCSI*, *CDROM*, *HDD-1*, *HDD-2*, *HDD-3*, *LAN* and *Disable*.

Boot Other Device

These fields allow the system to search for an operating system from other devices other than the ones selected in the First/Second/Third Boot Device.

Swap Floppy Drive

This item allows you to determine whether or not to enable Swap Floppy Drive. When enabled, the BIOS swaps floppy drive assignments so that Drive A becomes Drive B, and Drive B becomes Drive A. By default, this field is set to *Disabled*.

Boot Up Floppy Seek

When enabled, the BIOS will seek whether or not the floppy drive installed has 40 or 80 tracks. 360K type has 40 tracks while 760K, 1.2M and 1.44M all have 80 tracks.

Boot Up NumLock Status

This allows you to activate the NumLock function after you power up the system.

Gate A20 Option

This field allows you to select how Gate A20 is worked. Gate A20 is a device used to address memory above 1 MB.

Typematic Rate Setting

When disabled, continually holding down a key on your keyboard will generate only one instance. When enabled, you can set the two typematic controls listed next. By default, this field is set to *Disabled*.

Typematic Rate (Chars/Sec)

When the typematic rate is enabled, the system registers repeated keystrokes speeds. Settings are from 6 to 30 characters per second.

Typematic Delay (Msec)

When the typematic rate is enabled, this item allows you to set the time interval for displaying the first and second characters. By default, this item is set to *250msec*.

Security Option

This field allows you to limit access to the System and Setup. The default value is *Setup*. When you select *System*, the system prompts for the User Password every time you boot up. When you select *Setup*, the system always boots up and prompts for the Supervisor Password only when the Setup utility is called up.

OS Select for DRAM > 64MB

This option allows the system to access greater than 64MB of DRAM memory when used with OS/2 that depends on certain BIOS calls to access memory. The default setting is *Non-OS/2*.

Report No FDD for Win95

This field has a default setting of *Yes*.

6.5 Advanced Chipset Features

This Setup menu controls the configuration of the motherboard chipset.

CMOS Setup Utility – Copyright © 1984-1999 Award Software
Advanced Chipset Features

		ITEM HELP
SDRAM CAS Latency Time	Auto	Menu Level
SDRAM Cycle Time Tras/Trc	6/8	
SDRAM RAS-to-CAS Delay	3	
SDRAM RAS Precharge Time	3	
System BIOS Cacheable	Enabled	
Video BIOS Cacheable	Enabled	
Memory Hole At 15M-16M	Disabled	
CPU Latency Timer	Enabled	
Delayed Transaction	Enabled	
On-Chip Video Window Size	64MB	
* Onboard Display Cache Setting *		
CAS# Latency	3	
Paging Mode Control	Open	
RAS-to-CAS Override	By CAS# LT	
RAS# Timing	Fast	
RAS# Precharge Timing	Fast	

SDRAM CAS Latency Time

You can select CAS latency time in HCLKs of 2/2 or 3/3. The system board designer should set the values in this field, depending on the DRAM installed. Do not change the values in this field unless you change specifications of the installed DRAM or the installed CPU. The choices are *Auto*, *2* and *3*.

SDRAM Cycle Time Tras/Trc

The settings available for the SDRAM Cycle Time Tras/Trc are 6/8 and 5/7. The default setting is *6/8*.

SDRAM RAS-to-CAS Delay

You can select RAS to CAS Delay time in HCLKs of 2/2 or 3/3. The system board designer should set the values in this field, depending on the DRAM installed. Do not change the values in this field unless you change specifications of the installed DRAM or the installed CPU. The choices are *2* and *3*.

SDRAM RAS Precharge Time

This option defines the length of time for Row Address Strobe is allowed to precharge. The choices are *2* and *3*.

System BIOS Cacheable

The setting of *Enabled* allows caching of the system BIOS ROM at F000h-FFFFh, resulting in better system performance. However, if any program writes to this memory area, a system error may result.

Video BIOS Cacheable

The Setting *Enabled* allows caching of the video BIOS ROM at C0000h-F7FFFh, resulting in better video performance. However, if any program writes to this memory area, a system error may result.

Memory Hole At 15M-16M

In order to improve performance, certain space in memory can be reserved for ISA cards. This memory must be mapped into the memory space below 16 MB. The choices are *Enabled* and *Disabled*.

CPU Latency Timer

This field enable or disable the CPU latency timer. The default setting is *Enabled*.

Delayed Transaction

The chipset has an embedded 32-bit posted write buffer to support delay transactions cycles. Select *Enabled* to support compliance with PCI specification version 2.1.

On-Chip Video Window Size

The setting choices for the On-Chip Video Window Size are *64MB* and *32MB*. By default, this option is set to *64MB*.

Onboard Display Cache Setting

The default setting and optional setting for the onboard display cache functions are as follows:

CAS# Latency	3(default), 2(option)
Paging Mode Control	Open (default), Close (option)
RAS-to-CAS Override	by CAS# LT (default), Override (2)(option)
RAS# Timing	Fast (default), Slow (option)
RAS# Precharge Timing	Fast (default), Slow (option)

6.6 Integrated Peripherals

This section sets configurations for your hard disk and other integrated peripherals.

CMOS Setup Utility – Copyright © 1984-1999 Award Software
Advanced Chipset Features

			ITEM HELP
On-Chip Primary	PCI IDE	Enabled	
On-Chip Secondary	PCI IDE	Enabled	Menu Level
IDE Primary Master	PIO	Auto	
IDE Primary Slave	PIO	Auto	
IDE Secondary Master	PIO	Auto	
IDE Secondary Slave	PIO	Auto	
IDE Primary Master	UDMA	Auto	
IDE Primary Slave	UDMA	Auto	
IDE Secondary Master	UDMA	Auto	
IDE Secondary Slave	UDMA	Auto	
USB Controller		Enabled	
USB Keyboard Support		Disabled	
Init Display First		PCI Slot	
AC97 Audio		Enabled	
AC97 Modem		Disabled	
IDE Block Mode		Enabled	
POWER ON Function		Button Only	
KB Power ON Password		Enter	
Hot Key Power ON		Ctrl-F1	
Onboard FDC Controller		Enabled	
Onboard Serial Port 1		3F8/IRQ4	
Onboard Serial Port 2		2F8/IRQ3	
UART Mode Select		Normal	
RxD, TxD Active		Hi, Lo	
IR Transmission Delay		Enabled	
UR2 Duplex Mode		Half (Full)	
Use IR Pins		IR, Rx2Tx2	
Onboard Parallel Port		378/IRQ7	
Parallel Port Mode		SPP	
EPP Mode Select		EPP1.7	
ECP Mode Use DMA		3	
PWRON After PWR-Fail		Off	
Game Port Address		201	
Midi Port Address		330	
Midi Port IRQ		10	

OnChip Primary/Secondary PCI IDE

The integrated peripheral controller contains an IDE interface with support for two IDE channels. Select *Enabled* to activate the channels.

IDE Primary/Secondary Master/Slave PIO

These fields allow your system hard disk controller to work faster. Rather than have the BIOS issue a series of commands that transfer to or from the disk drive, PIO (Programmed Input/Output) allows the BIOS to communicate with the controller and CPU directly.

The system supports five modes, numbered from 0 (default) to 4, which primarily differ in timing. When Auto is selected, the BIOS will select the best available mode.

IDE Primary/Secondary Master/Slave UDMA

These fields allow your system to improve disk I/O throughput to 66Mb/sec with the Ultra DMA/66 feature. The options are *Auto* and *Disabled*.

USB Controller

The options for this field are *Enabled* and *Disabled*. By default, this field is set to *Enabled*.

USB Keyboard Support

By default, the USB Keyboard Support field is set to *Disabled*.

Init Display First

This field allows the system to initialize first the VGA card on chip or the display on the PCI Slot. By default, the *PCI Slot* VGA is initialized first.

AC97 Audio

By default, the AC97 Audio is set to *Enabled*.

AC97 Modem

By default, the AC97 Modem is set to *Disabled*.

IDE HDD Block Mode

This field allows your hard disk controller to use the fast block mode to transfer data to and from your hard disk drive.

POWER ON Function

This field allows powering on by the following methods:

Password	Keyboard 98
Hot KEY	BUTTON ONLY

Onboard FDD Controller

Select *Enabled* if your system has a floppy disk controller (FDC) installed on the motherboard and you wish to use it. If you install an add-in FDC or the system has no floppy drive, select *Disabled* in this field. This option allows you to select the onboard FDD port.

Onboard Serial/Parallel Port

These fields allow you to select the onboard serial and parallel ports and their addresses. The default values for these ports are:

Serial Port 1	3F8/IRQ4
Serial Port 2	2F8/IRQ3
Parallel Port	378H/IRQ7

UART Mode Select

This field determines the UART mode in your computer. The default value is *Normal*. Other options include *IrDA* and *ASKIR*.

Onboard Parallel Port

The setting for this field are *378/IRQ7*, *278/IRQ5*, *2BC/IRA7* and *Disabled*. By default, the onboard parallel port is set to *378/IRQ7*.

Onboard Parallel Port

The setting for this field are *378/IRQ7*, *278/IRQ5*, *2BC/IRA7* and *Disabled*. By default, the onboard parallel port is set to *378/IRQ7*.

RxD, TxD Active

The settings for this field are *Hi,Lo*, *Lo,Hi*, *Lo,Lo*, and *Hi,Hi*.

IR Transmission Delay

By default, this field is set to *Enabled*.

UR2 Duplex Mode

The settings available for this field are *Half* (default) and *Full*.

Use IR Pins

The settings for this field are *IR*, *Rx2Tx2* (default) and *RxD2, TxD2*.

PWRON After PW-Fail

In case of power failure, the system can be configured to power on or to remain off when the power returns. These two settings are *Former-Sts* and *Off* respectively. The default setting for this field is *Off*.

Game Port Address

The settings for this field are *201* (default), *209* and *Disabled*.

Midi Port Address

The option settings for this field are *330*, *300*, *290* and *Disabled*. The default setting is *330*.

Midi Port IRQ

The option settings for this field are *5* and *7*. The default setting is *7*.

6.7 Power Management Setup

The Power Management Setup allows you to save energy of your system effectively. It can shut down devices after a period of inactivity.

CMOS Setup Utility – Copyright © 1984-1999 Award Software
Power Management Setup

ACPI Function	Enabled	ITEM HELP
ACPI Suspend Type	S1 (POS)	Menu Level
Power Management	User Define	
Video Off Method	DPMS	
Video Off In Suspend	Yes	
Suspend Type	Stop Grant	
Modem Use IRQ	3	
Suspend Mode	Disabled	
HDD Power Down	Disabled	
Soft-Off by PWR-BTTN	Instant-Off	
Wake-Up by PCI Card	Disabled	
Power On by Modem/LAN	Disabled	
CPU Thermal-Throttling	62.5%	
Resume by Alarm	Disabled	
Date (of Month) Alarm	0	
Time (hh:mm:ss) Alarm	0	
** Reload Global Timer Events **		
Primary IDE 0	Disabled	
Primary IDE 1	Disabled	
Secondary IDE 0	Disabled	
Secondary IDE 1	Disabled	
FDD, COM, LPT Port	Disabled	
PCI PIRQ[A-D] #	Disabled	

ACPI Function

This field allows you to enabled or disable the ACPI function on the motherboard. By default, this field is set to *Disabled*.

ACPI Suspend Type

The options for the ACPI Suspend Type field are *S1(POS)* and *S3(STR)*. The default setting for this field is *S1(POS)*.

Note: The S3(STR) hardware is optional.

Power Management

This field allows you to select the type of power saving management modes. There are four selections for Power Management.

- Min. Power Saving Minimum power management
- Max. Power Saving Maximum power management.
- User Define Each of the ranges is from 1 min. to 1hr.
- Except for HDD Power Down which
- ranges from 1 min. to 15 min.
- (Default)

Video Off Method

This field defines the Video Off features. There are three options.

V/H SYNC + Blank	Default setting, blank the screen and turn off vertical and horizontal scanning.
DPMS	Allows the BIOS to control the video display card if it supports the DPMS feature.
Blank Screen	This option only writes blanks to the video buffer.

Video Off in Suspend

When enabled, the video is off in suspend mode. The default setting is *Yes*.

Suspend Type

The settings for this field are *Stop Grant* (default) and *PwrOn Suspend*.

Modem Use IRQ

This field sets the IRQ used by the Modem. By default, the IRQ used is 3.

Suspend Mode

When enabled, and after the set time of system inactivity, all devices except the CPU will be shut off.

HDD Power Down

When enabled, and after the set time of system inactivity, the hard disk drive will be powered down while all other devices remain active.

Soft-Off by PWRBTN

This field defines the power-off mode when using an ATX power supply. The *Instant Off* mode allows powering off immediately upon pressing the power button. In the *Delay 4 Sec* mode, the system powers off when the power button is pressed for more than four seconds or enters the suspend mode when pressed for less than 4 seconds. The default value is *Instant Off*.

Wake-Up by PCI Card

The settings for this field are *Enabled* and *Disabled* (default).

Power On by Modem/LAN

This field enables or disables the power on of the system through the modem connected to the serial port or LAN.

CPU Thermal-Throttling

The CPU Thermal Throttling function, by default, is set to 62.5%

Resume by Alarm

This field enables or disables the resumption of the system operation. When enabled, the user is allowed to set the *Date* and *Time*.

Reload Global Timer Events

The HDD, FDD, COM, LPT Ports, and PCI PIRQ are I/O events which can prevent the system from entering a power saving mode or can awaken the system from such a mode. When an I/O device wants to gain the attention of the operating system, it signals this by causing an IRQ to occur. When the operating system is ready to respond to the request, it interrupts itself and performs the service.

6.8 PNP/PCI Configurations

This option configures the PCI bus system. All PCI bus systems on the system use INT#, thus all installed PCI cards must be set to this value.

CMOS Setup Utility – Copyright © 1984-1999 Award Software
PnP/PCI Configurations

Reset Configuration Data	Disabled	ITEM HELP
Resources Controlled By IRQ Resources	Auto (ESCD) Press Enter	Menu Level
PCI/VGA Palette Snoop	Disabled	Default is Disabled. Select Enabled to reset Extended System Configuration Data (ESCD) when you exit Setup if you have installed a new add-on and the system reconfiguration has caused such a serious conflict that the OS cannot boot

Reset Configuration Data

This field allows you to determine whether to reset the configuration data or not. The default value is **Disabled**.

Resources Controlled By

The settings for this field are *Auto (ESCD)* (default) and *Manual*.

IRQ Resources

To configure the IRQ Resources, the *Resource Controlled By* field should be set to *Manual*.

PCI/VGA Palette Snoop

Some non-standard VGA display cards may not show colors properly. This field allows you to set whether or not MPEG ISA/VESA VGA Cards can work with PCI/VGA. When this field is enabled, a PCI/VGA can work with an MPEG ISA/VESA VGA card. When this field is disabled, a PCI/VGA cannot work with an MPEG ISA/VESA Card.

6.9 PC Health Status

This section shows the parameters in determining the PC Health Status. These parameters include temperatures, fan speeds and voltages.

CMOS Setup Utility – Copyright © 1984-1999 Award Software
PC Health Status

		ITEM HELP
CPU Warning Temperature	66°C/151°F	
Current System Temp.	32°C/89°F	
Current CPU Temperature	38°C/100°F	
Current CPUFAN Speed	4470 RPM	
Current AMR/PCI Speed	0 RPM	
Current Chassis FAN Speed	0 RPM	
VCCP(V)	1.98 V	
+1.8V(V)	1.76 V	
+3.3V (V)	3.34 V	
+ 5 V	4.97 V	
+12 V	11.91V	
-12 V	12.03V	
- 5 V	5.04 V	
VBAT (V)	3.50 V	
5VSB (V)	5.29 V	
Shutdown Temperature	75°C/167°F	

Temperatures/Fan Speeds/Voltages

These fields are the parameters of the hardware monitoring function feature of the motherboard. The values are read-only values as monitored by the system and show the PC health status.

Shutdown Temperature

This field allows the user to set the temperature by which the system automatically shuts down once the threshold temperature is reached. This function can help damage to the system that is caused by overheating.

6.10 Frequency/Voltage Control

This section shows the user how to configure the key components.

CMOS Setup Utility – Copyright © 1984-1999 Award Software
Frequency/Voltage Control

Auto Detect DIMM/PCI Clk	Disabled	ITEM HELP
Spread Spectrum	Disabled	Menu Level
Host CPU/PCI Clock	Default	
CPU Clock Ratio	X3	

Auto Detect DIMM/PCI Clk

The settings for this field are *Enabled* and *Disabled* (default).

Spread Spectrum

This field sets the value of the spread spectrum. The default setting is *Disabled*. This field is for CE testing use only.

Host CPU/PCI Clock

The Host CPU/PCI Clock has a default setting of *Default* which is either 66/33MHz or 100/33MHz as automatically detected by the system. The options are as follows: For CPU with 66MHz FSB, the options are 66/33MHz (Default), 75/37MHz, and 80/40 MHz. For CPU with 100MHz FSB, options are 100/33MHz (Default), 112/37MHz, 117/39MHz, 129/43MHz, 133/33MHz, 138/46MHz, 140/35MHz, 150/37MHz, 166/41MHz, 180/30MHz, 190/31MHz and 200/33MHz.

NOTE: *Overclocking could cause the system not to boot. When this happens, turn off the computer by pressing the power button and turn it on again by pressing the **Insert** key and the power button simultaneously. Then press the **Delete** key to enter BIOS Setup and configure the CPU speed.*

CPU Clock Ratio

The CPU Ratio, also known as the CPU bus speed multiplier, can be configured as 3, 3.5, 4, 4.5, 5, 5.5, 6, 6.5, 7, 7.5, and 8.

6.11 Load Fail-Safe Defaults

This option allows you to load the troubleshooting default values permanently stored in the BIOS ROM. These default settings are non-optimal and disable all high-performance features.

CMOS Setup Utility – Copyright © 1984-1999 Award Software
Load Fail-Safe Defaults

Standard CMOS Features	Frequency/Voltage Control
Advanced BIOS Features	Load Fail-Safe Defaults
Advanced Chipset Features	Load Optimized Defaults
Integrated Peripherals	Set Supervisor Password
Power Management Setup	Set User Password
PnP/PCI Configurations	Save & Exit Setup
PC Health Status	Exit Without Saving
ESC : Quit	↑ ↓ → ← : Select Item
F10 : Save & Exit Setup	

6.12 Load Setup Defaults

This option allows you to load the default values to your system configuration. These default settings are optimal and enable all high performance features.

CMOS Setup Utility – Copyright © 1984-1999 Award Software
Load Optimized Defaults

Standard CMOS Features	Frequency/Voltage Control
Advanced BIOS Features	Load Fail-Safe Defaults
Advanced Chipset Features	Load Optimized Defaults
Integrated Peripherals	Set Supervisor Password
Power Management Setup	Set User Password
PnP/PCI Configurations	Save & Exit Setup
PC Health Status	Exit Without Saving
ESC : Quit	↑ ↓ → ← : Select Item
F10 : Save & Exit Setup	

6.13 Set Supervisor/User Password

These two options set the system password. Supervisor Password sets a password that will be used to protect the system and Setup utility. User Password sets a password that will be used exclusively on the system. To specify a password, highlight the type you want and press <Enter>. The Enter Password: message prompts on the screen. Type the password, up to eight characters in length, and press <Enter>. The system confirms your password by asking you to type it again. After setting a password, the screen automatically returns to the main screen.

To disable a password, just press the <Enter> key when you are prompted to enter the password. A message will confirm the password to be disabled. Once the password is disabled, the system will boot and you can enter Setup freely.

CMOS Setup Utility – Copyright © 1984-1999 Award Software

Standard CMOS Features	Frequency/Voltage Control
Advanced BIOS Features	Load Fail-Safe Defaults
Advanced Chipset Features	Load Optimized Defaults
Integrated Peripherals	Set Supervisor Password
Power Management Setup	Set User Password
PnP/PCI Configurations	Save & Exit Setup
PC Health Status	Exit Without Saving
ESC : Quit	↑ ↓ → ← : Select Item
F10 : Save & Exit Setup	

6.14 Save & Exit Setup

This option allows you to determine whether or not to accept the modifications. If you type “Y”, you will quit the setup utility and save all changes into the CMOS memory. If you type “N”, you will return to Setup utility.

CMOS Setup Utility – Copyright © 1984-1999 Award Software
Save & Exit Setup

Standard CMOS Features	Frequency/Voltage Control
Advanced BIOS Features	Load Fail-Safe Defaults
Advanced Chipset Features	Load Optimized Defaults
Integrated Peripherals	Set Supervisor Password
Power Management Setup	Set User Password
PnP/PCI Configurations	Save & Exit Setup
PC Health Status	Exit Without Saving
ESC : Quit	↑ ↓ → ← : Select Item
F10 : Save & Exit Setup	

6.15 Exit Without Saving

Select this option to exit the Setup utility without saving the changes you have made in this session. Typing “Y” will quit the Setup utility without saving the modifications. Typing “N” will return you to Setup utility.

CMOS Setup Utility – Copyright © 1984-1999 Award Software
Exit Without Saving

Standard CMOS Features	Frequency/Voltage Control
Advanced BIOS Features	Load Fail-Safe Defaults
Advanced Chipset Features	Load Optimized Defaults
Integrated Peripherals	Set Supervisor Password
Power Management Setup	Set User Password
PnP/PCI Configurations	Save & Exit Setup
PC Health Status	Exit Without Saving
ESC : Quit	↑ ↓ → ← : Select Item
F10 : Save & Exit Setup	

This page was intentionally left blank.

Chapter 7 Intel 810 DC-100/810E Drivers Installation

This chapter describes the installation of the drivers in conjunction with the Intel 82810 DC-100/810E chipset. The topics covered in this chapter include:

Installing Intel 82810 DC-100/810E Define Drivers for Windows 95/98.....	52
Installing Intel 82810 DC-100/810E VGA Driver for Windows 95/98	55
Installing Intel 82810 DC-100/810E VGA Driver for Windows NT	58
Installing Intel 82810 DC-100/810E Audio Driver for Windows 95/98/NT	60

Installing Intel 82810 DC-100/810E Define Drivers for Windows 95/98

1. After you have installed Windows 95/98, install the Intel 82810 DC-100/810E define drivers. Insert the driver CD provided with the motherboard. Once it is inserted, the following screen appears.



2. Click **Intel M/B Drivers** and the following screen appears.



3. Click **Intel 82810 DC-100/810E Driver**, then **Intel 82810 DC-100/810E Define Driver** and the welcome screen appears.

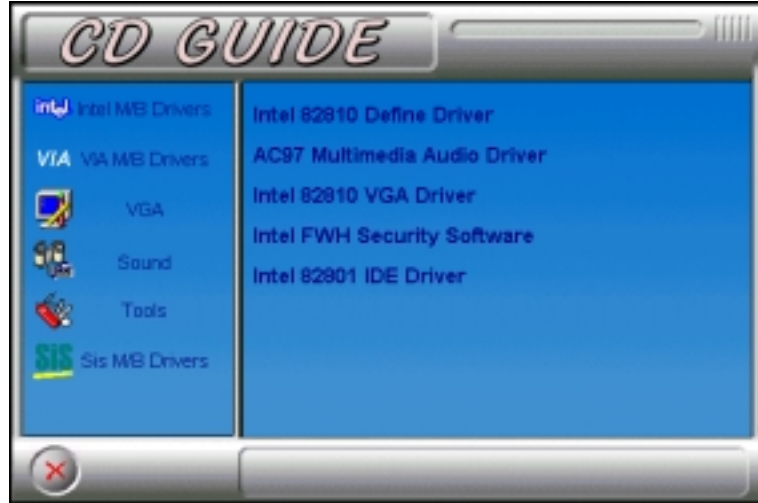

4. Click **Next** and **Next** to start copying files. After the installation is done, click **Finish** to restart the computer.



5. When Windows restarts, the Add New Hardware Wizard screen would appear as Windows searches the driver for Intel® 82802 firmware Hub Device. Click **Next** to “search for the best driver for the device”. Click **Next** again for Windows to start searching for the driver. The Insert Disk screen will appear and prompt you to enter the path of the file **iFWH.cat**. The file is located in the **i810cat** subdirectory under the Windows directory. (You may click on **Browse** to find the correct path.) When the correct path is entered and the files are copied, click **Finish**.
6. At this stage, the Add New Hardware Wizard searches for the drivers for *Intel 82810 DC-100/810E System and Graphics Controller*. Follow the instructions on the screen to install the drivers.
7. After the drivers are installed, the wizard starts to find other hardware available in the system. The wizard will also search for the drivers of the *Standard PCI Graphics Adapter (VGA)*. Follow the instructions on the screen. When Windows prompts you to restart the computer, click **Yes**.

Installing Intel 82810 DC-100/810E VGA Driver for Windows 95/98

1. After you have installed Windows 95/98, install the Intel 82810DC-100/815E VGA driver. Insert the driver disk provided with the motherboard. Once it is inserted, the following screen appears.



2. Click **Intel M/B Drivers** and the following screen appears.



3. Click **Intel 82810 DC-100/810E Drivers**, then **Intel 82810 DC-100/810E VGA Driver**. When the Welcome screen appears, click **Next**.

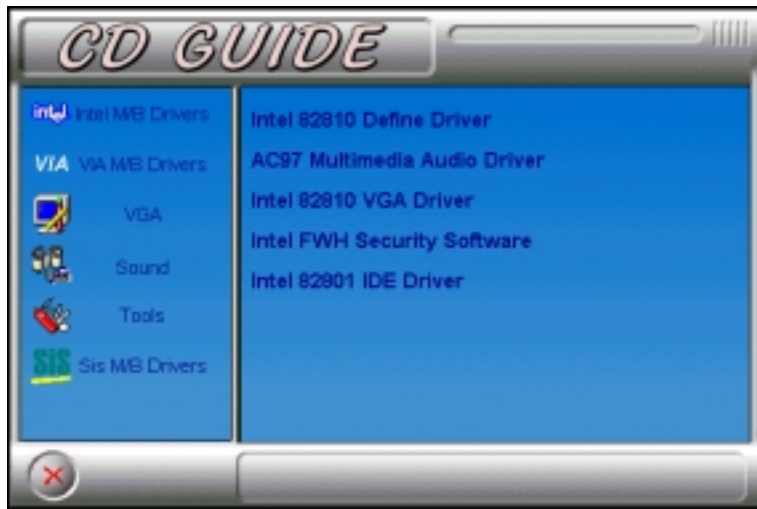

4. When the Choose Destination Location window appears, click **Next** to start copying of files. After the files are copied, restart your computer for changes to take effect.



Installing Intel 82810 DC-100/810E VGA Driver for Windows NT

1. After you have installed Windows NT, install the Intel 82810 DC-100/810E VGA driver. Insert the driver disk provided with the motherboard. Once it is inserted, the following screen appears.



5. Click **Intel M/B Drivers** and the following screen appears.



- Click **Intel 82810DC-100/810E Drivers**, then **Intel 82810 DC-100/810E VGA Driver**. When the Welcome screen appears, click **Next**.

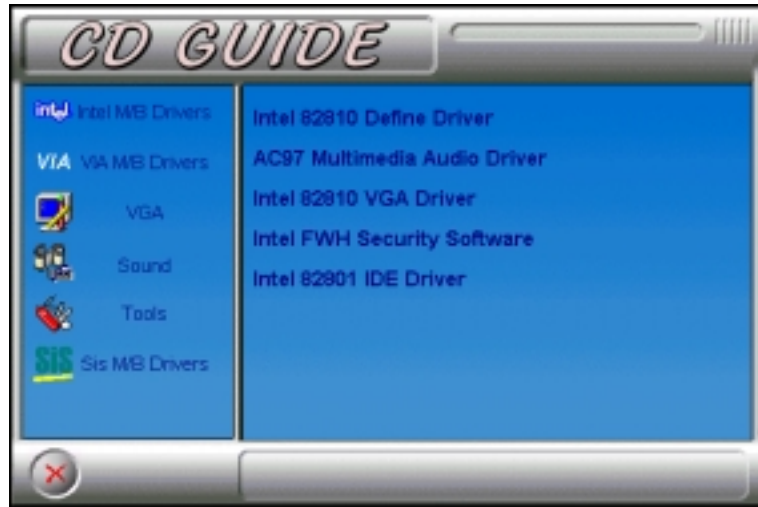

- Click **Next** when the Welcome screen appears. Click **Yes** when the Software License Agreement screen appears. When the Choose Destination Location window appears, click **Next** to start copying of files. After the files are copied, restart your computer for changes to take effect.

Installing Intel 82810 DC-100/810E Audio Driver for Windows 95/98/NT

The FI7WBM supports AC97 codec from Sigmatel. Please follow the procedure below on how to install the drivers. Basically the steps are the same for all of these operating systems. *Please note that Windows 2000 support the Intel 82810DC-100/810E driver; hence, it is optional to install this driver. The procedure will be the same as the one mentioned below.*

1. After you have installed Windows 95/98/NT, install the Intel 82810DC100/810E audio driver. Insert the driver disk provided with the motherboard. Once it is inserted, the following screen appears.



2. Click **Intel M/B Drivers** and the following screen appears.



3. Click **Intel 82810 DC-100/810E Drivers**, then **AC97 Multimedia Audio Driver**. When the Welcome screen appears, click **Next** to start copying files. Restart the computer when you are prompted.

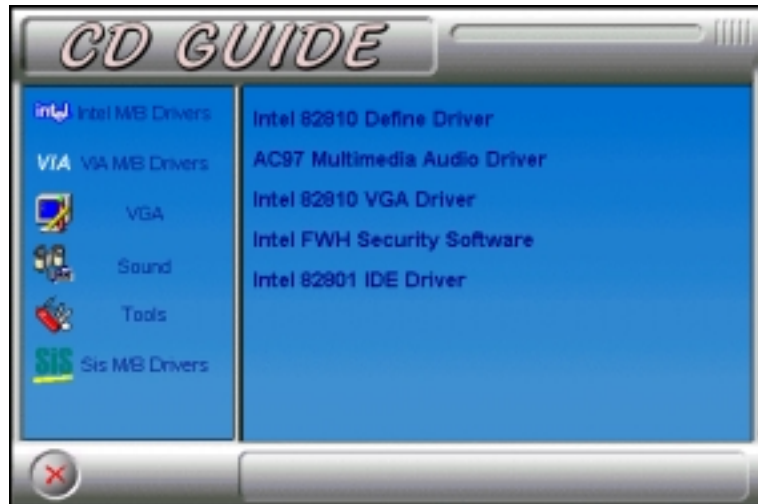

Appendix

Appendix and Errata

The manufacturer sees to it that the most up-to-date and accurate information are contained in this manual. This section would contain page insert(s) of additional information, updates or corrections that the user should know to ensure that proper configuration and setup of the motherboard is made.