

Handling Precautions



CAUTION

High potential static charge can cause damage to the integrated circuits on the board. Before handling any mainboard outside of its protective packaging, ensure that there is no static electric charge on your body.

Danger of explosion if battery is incorrectly replaced. Replace only with the same or equivalent type recommended by the manufacturer.

- ◆ Keep the board in its anti-static bag until you are ready to install it.
- ◆ Protect your board from static electricity by well grounding of your body and the equipment during the installation, such as wearing a grounded wrist strap.
- ◆ Always handle the board by its edges.
- ◆ Do not touch with the components on the boards, add-on cards and modules, or the “gold finger” connectors going to be plugged into the expansion slot. It is best to handle system components by their mounting bracket.
- ◆ Ensure the system power is completely turn-off before doing any installation work.

Notice to Customers

The information contained in this User's Guide with no liability whatsoever, and disclaims any express or implied warranty, relating to sale and/or use of products including liability or warranties relating to fitness for a particular purpose, merchantability, or infringement of any patent, copyright or other intellectual property right. We shall not be liable for any loss or profits, loss of business, loss of use or data, interruption of business, or for indirect, special, incidental, or consequential damages arising from any defect or error in this User's Guide or product.

We retains the right to make changes on this User's Guide and product descriptions at any time, without notice.



Trademarks™

VIA is a registered trademark of VIA Technologies, Incorporated.

Intel®, **Pentium®** are registered trademarks of Intel Corporation.

IBM, **IBM PC**, **IBM PC/AT**, **PC-DOS**, **OS/2** and **OS/2 WARP** are registered trademarks of International Business Machines Corporation.

MS-DOS, **Windows** and **Windows 95** are registered trademarks of Microsoft Corporation.

AMI BIOS is a product of American Megatrends Inc.

Sound Blaster and **Blaster** are registered trademarks in U.S.A. and/or other countries.

SB-LINK DynaRAM and WavEffects are trademarks of Creative Technology Ltd.

Third-party brands and names mentions in this User's Guide are the property of their respective owners.

User's Guide Revision : 1.00

Release Date : July 1998

Copyright © 1998, All rights reserved.



Table of Contents

FEATURES OF THE BOARD.....	1
OVERVIEW	1
AUTO JUMPER YES	1
FEATURES SUMMARY	1
MOTHERBOARD INSTALLATION.....	3
INSTALLATION PRECAUTIONS.....	3
A QUICK INTRODUCTION	3
JUMPERS SETTING	3
Jumpers.....	3
CPU INSTALLATION.....	4
INSTALLING SYSTEM MEMORY (RAM).....	5
EXPANSION CARDS INSTALLATION.....	7
CONNECTING EXTERNAL CONNECTOR	7
AT Power Connector	7
ATX Power Connector	8
Floppy Drive Connector	8
IDE Connectors.....	8
Front Panel Function Connectors.....	9
REPLACING BATTERY.....	10
QUICK INSTALLATION GUIDE.....	11
“Auto Jumper Yes” Guide	13
“CPU Voltage Selection”	13
QUICK REFERENCE OF YOUR MOTHERBOARD	16
AMICMOS SETUP.....	19
STANDARD CMOS SETUP	20
CPU SETUP.....	22
ADVANCED CMOS SETUP.....	23
ADVANCED CHIPSET SETUP	26
PCI/PNP SETUP.....	28
POWER MANAGEMENT SETUP.....	31
PERIPHERAL SETUP	34
MOTHERBOARD TECHNICAL SPECIFICATION.....	37
ENVIRONMENT	37
DIMENSIONS AND WEIGHT	37
ELECTRICAL SPECIFICATION	37
POWER CONSUMPTION.....	37
REQUEST FOR TECHNICAL SUPPORT	38

Features of the Board

Overview

Congratulations on purchasing the highest performance Pentium® motherboard. With the advanced technology available today, this motherboard is designed to run Intel's Pentium processors at speeds up to 233 MHz. The on-board system memory consists of SIMM and DIMM giving you the most flexibility for system design. It supports up to 128 MB of DRAM using standard 72-pin SIMM sockets that accept either Fast Page Mode (FPM), Extended Data Out (EDO) memory. In addition, two unbuffered, 3.3 Volts, 168-pin SDRAM sockets are also included for 16 to 256MB synchronous Dynamic memory support. A 321-pins type 7, Zero Insertion Force (ZIF) socket allows an easy upgrade path for the future Pentium Overdrive® processors.

The motherboard uses VIA VT82580VPX PCI chipset. The VIA VT82C586B PCI/ISA Bridge provides an integrated Bus Mastering IDE controller with two high performance UltraDMA-33 EIDE interfaces for up to four IDE devices (such as hard drives or CD-ROM). The PCI/ISA Bridge also including an USB interface. The integrated I/O controller integrates the standard PC I/O functions: floppy interface, two FIFO serial ports, one EPP/ECP capable parallel port, and support for an IrDA and Consumer Infra Red compatible interface.

Four on-board 32-bit PCI local bus slots allow a higher bandwidth data path, which serves as a super highway for intensive data-movement such as video or networking. The BIOS support PCI bridge user configuration, which allows further expansion of the system with PCI peripherals. Up to two 16-bit ISA slots are provided so that the board is backward hardware compatible with the older expansion card. A total of five expansion slots can be populated with add-in cards as one PCI and ISA slots share the same chassis I/O panel. Two full lengths ISA add-in cards can be installed while the third can be half-length. All PCI cards can be full lengths.

Auto Jumper Yes

This motherboard is one of our "Auto Jumper Yes" series, which eliminates the necessity for the user to be bored by jumper settings on the motherboard. It is capable of detecting the CPU brand, and setting the appropriate CPU core voltage and speed according to instructions from the user through CMOS setup menu. In contrast to "Jumperless", "Auto Jumper Yes" allows switching to manual mode that enables physical jumpers on the mainboard, so as to prevent the potential impacts on jumperless boards from the future CPU specifications. On the other hand, pressing "F" to clear CMOS setting and "J" to re-detect CPU during power on the system, to avoid the difficulties to reset the CMOS data.

Features Summary

This motherboard comes with following features:

- Supports Intel Pentium® Processor up to 233MHz, which included the newest MMX CPU.
- VIA VPX PCIsset, including a 82C585VPX PCI/Memory controller , 82C587 data bus Accelerator and 82C586B PCI ISA IDE Accelerator.
- WAKEUP-LINK interface header supporting Intel Wake-On-LAN
- TA-LINK interface headers supporting E100+ PCI LAN Card using the Intel™ LAN chip.

- ✓ Supports “Modems Ring On” (Requires ATX power supply and External COM2)
- ✓ PnP BIOS with support for power management, UltraDMA33/EIDE/SCSI features and desktop management interface (DMI) which allows higher level of hardware compatibility.
- ✓ Flash BIOS for easy upgrade
- ✓ Up to 2 each 72-pin SIMM sockets, supports up to 128 MB DRAM in two banks, which included FPM, EDO DRAM types
- ✓ The total of two high speed unbuffered SDRAM sockets, supports 16-256M memory.
- ✓ Two 16-bit ISA expansion slots and four 32-bit PCI expansion slots.
- ✓ Integrated two PCI bus master UltraDMA-33 EIDE controller with two on-board connectors supports up to four IDE devices such as Hard Disk, CD-ROM or Tape Backup drives. USB interface also provided.
- ✓ Integrated I/O chipset featuring one floppy disk controller, two 16550 UART compatible serial ports, one high speed EPP/ECP capable parallel port, one Infra Red port.

performance.

CPU Installation

The motherboard provides a 321-pins, type-7, ZIP socket. The CPU should have a fan attached to it to prevent overheating. If this is not the case then purchase a fan before you turn-on the system.

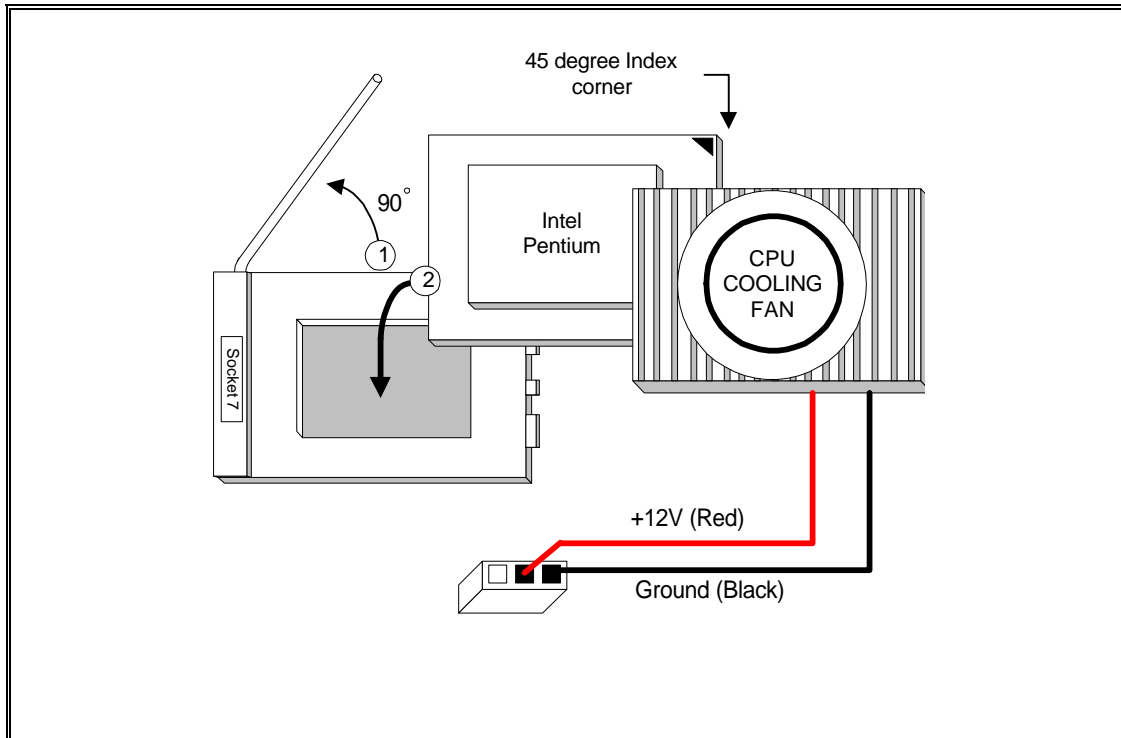

CPU Installation Diagram

! CAUTION

Without a effective cooling fan, the CPU can overheat and cause damage to both the CPU and the motherboard.

INSTALLING SYSTEM MEMORY (RAM)

The motherboard supports two 72-pin SIMMs (Single-In-Line Memory Modules) from 8MB up to 256MB memory size and two 168-pin DIMM. The four 72-pin SIMMs sockets are divided into two memory banks, Bank 0 and Bank 1, and each bank has two SIMM sockets which accept either FPM or EDO DRAM module.

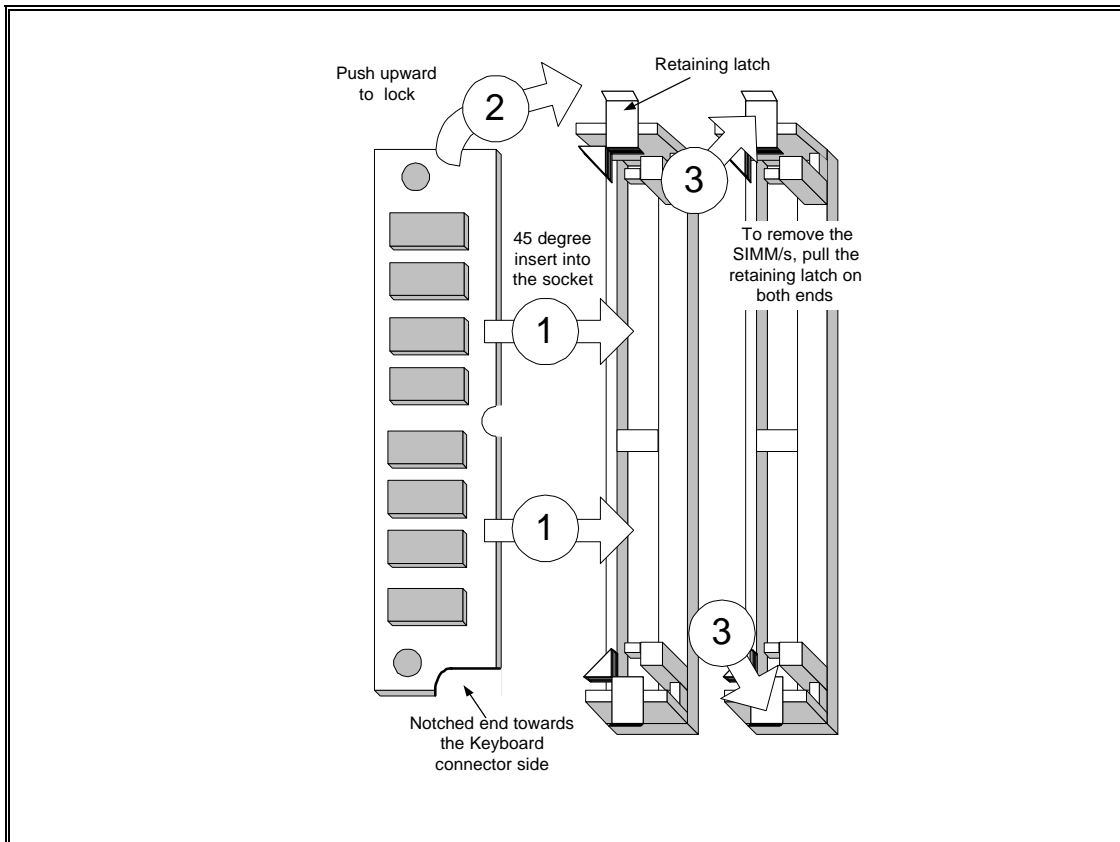

SIMM Module Installation Diagram

! CAUTION

Each bank must have the same size and type of memory module installed in pairs.

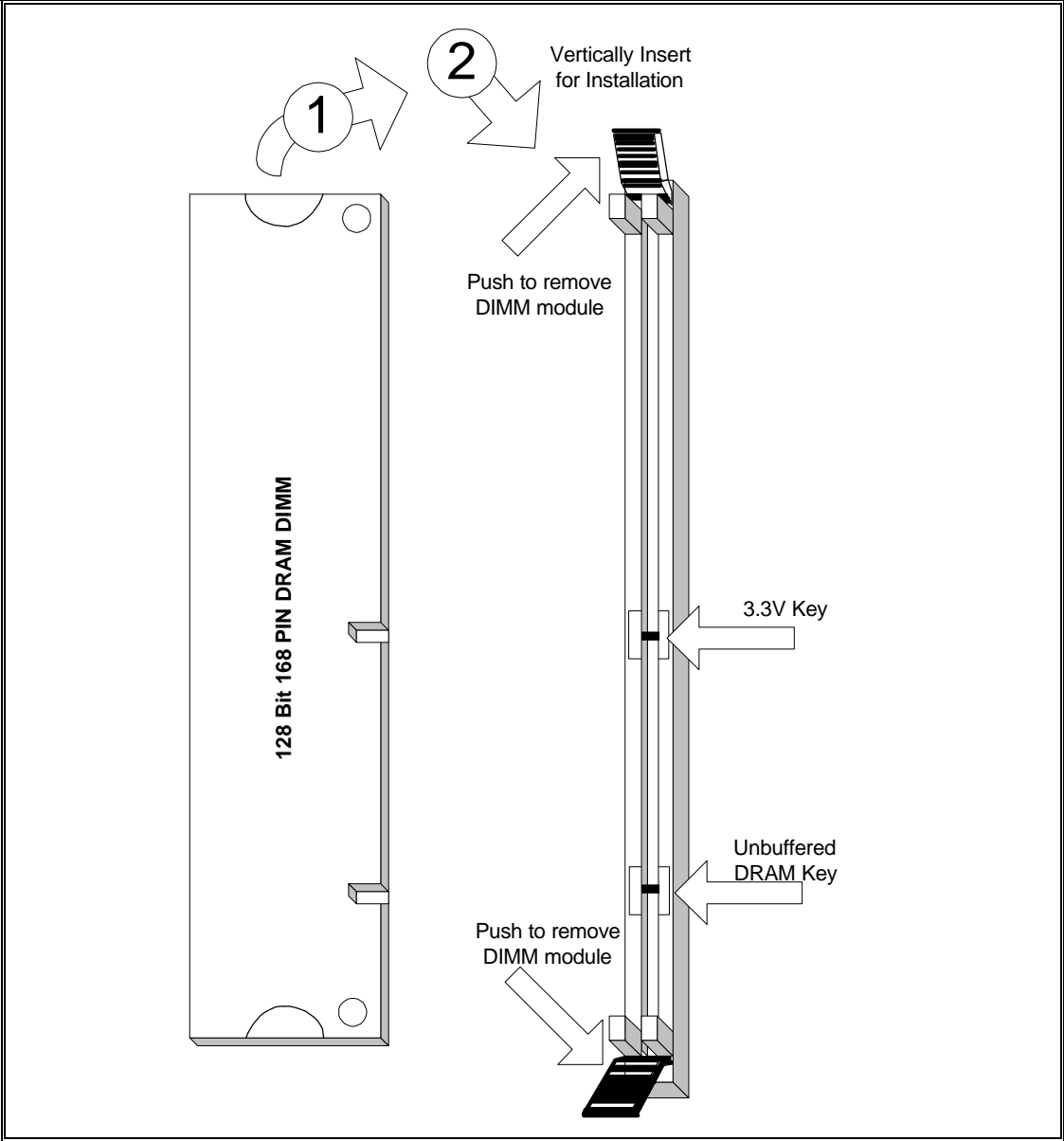

168-Pin SDRAM Module Installation Diagram

! CAUTION

SDRAM Module cannot be used together with the SIMMs Module.

EXPANSION CARDS INSTALLATION

At the most of beginning, you must read your expansion card documentation on any hardware and software settings that may be required. The installation procedures are summarized as below:

1. Read the User's Guide/Manual of your expansion card.
2. If necessary, set any jumpers on your expansion card.
3. Power-off the system and then disconnected the power cord.
4. Remove your computer's cover.
5. Remove the metal bracket from one of the empty slot, ISA or PCI, corresponding to the type of expansion card.
6. Carefully align the card's connectors and press firmly, make sure that the connection is good.
7. Secure the card on the slot.
8. Replace the computer's cover.
9. Setup the BIOS configuration if necessary.
10. Install the required software drivers for your expansion card.

CAUTION

Before adding or removing any expansion card or other system components, make sure that you unplug your system power supply. Failure to do so may cause damage of your motherboard and expansion cards.

CONNECTING EXTERNAL CONNECTOR

AT Power Connector

A 12-Pin power supplies provide two plugs incorporates standard $\pm 5V$ and $\pm 12V$, each containing six wires, two of which are black. Orient the connectors so that the black wires are together.

Pin	Signal Name	Pin	Signal Name
1	Power Good Signal	7	Ground
2	+5V	8	Ground
3	+12V	9	-5V
4	-12V	10	+5V
5	Ground	11	+5V
6	Ground	12	+5V

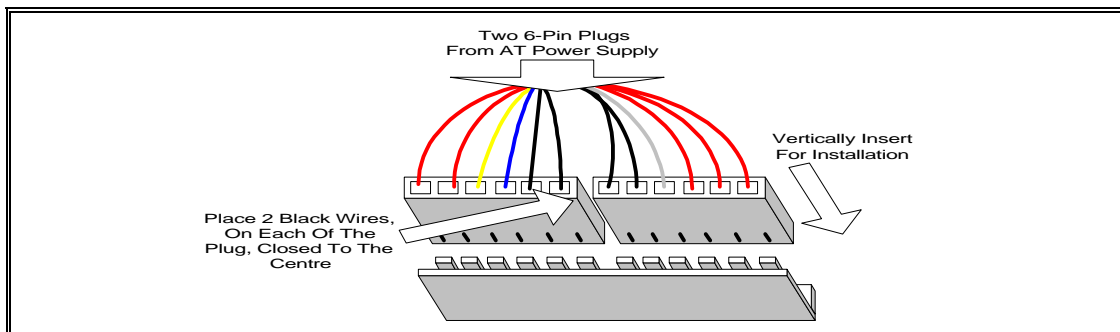

AT Power Connector Installation

ATX Power Connector

A single 20-pin connector incorporates standard $\pm 5V$ and $\pm 12V$, optional 3.3V and soft-power signals. With a power supply supports remote power on/off, the motherboard can turn off the system power through software control, such as the shutdown in Windows 95 Start menu. The system BIOS will turn the system power off when it receives the proper APM command from the OS. APM must be enabled in the system BIOS and OS in order for the soft-off feature to work correctly.

Pin	Signal Name	Pin	Signal Name
1	+3.3V	11	+3.3V
2	+3.3V	12	-12V
3	Ground	13	Ground
4	+5V	14	PW_ON
5	Ground	15	Ground
6	+5V	16	Ground
7	Ground	17	Ground
8	PWRGOOD	18	-5V
9	+5VSB	19	+5V
10	+12V	20	+5V

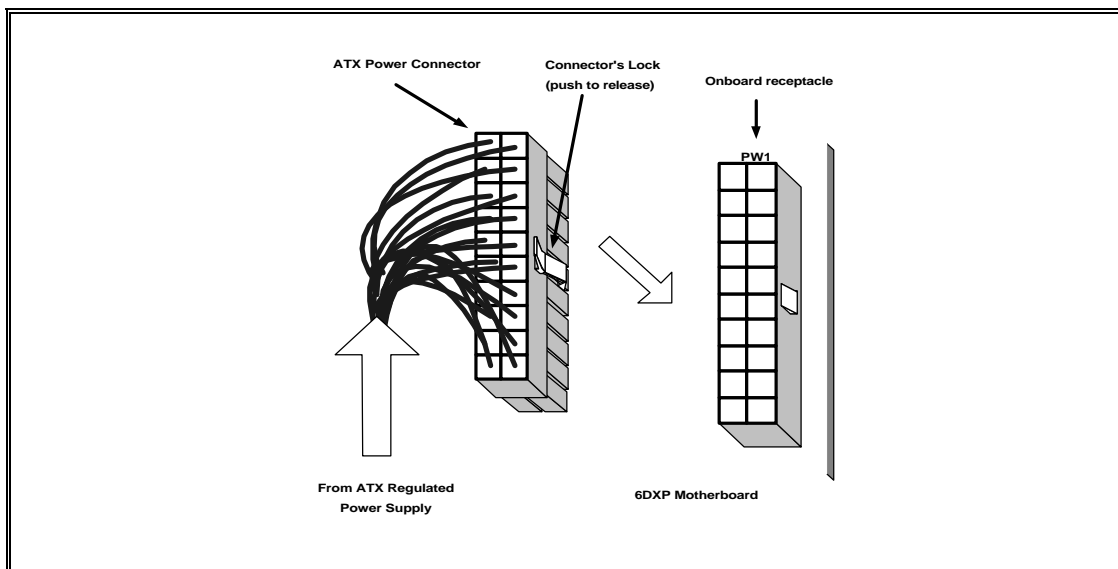

ATX Power Connector Installation

Floppy Drive Connector

This 34-pin connector supports the provided floppy drive ribbon cable. After connecting the single end to the on-board "FLOPPY" connector, connect the remaining plugs on the other end to the floppy drives correspondingly.

IDE Connectors

The two on-board IDE connectors support the provided 40-pin IDE hard disk ribbon cable. After connecting the single end to the board, connect the two remaining plugs at the other end of your hard disk(s). If you install two hard disks, you must configure the two drives by setting its jumpers according to the documentation of your hard disk. Also, you may connect the two hard disks to be both Masters using one ribbon cable on the primary IDE connector and one on the secondary IDE connector.

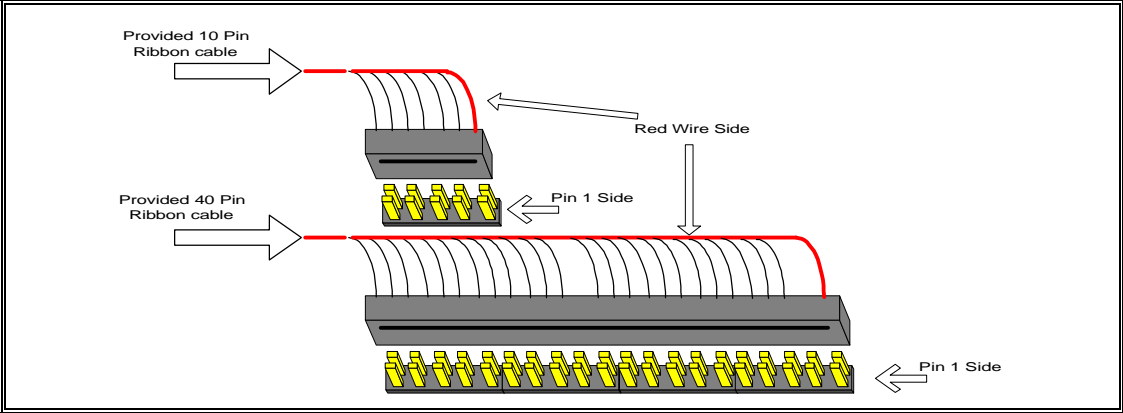

Ribbon cable Installation Example

NOTICE

For the flat ribbon cable connection, please make sure that the pin 1 of the ribbon cable (the red wire side of the cable) is correctly connected to the on-board connector’s pin 1 as shown on the “Map of the Motherboard”.

Front Panel Function Connectors

All the front panel indicator, speaker, and switch functions are grouped into a on-board 26-pin connector, J5. Front panel features supported include:

- System Reset, RESET
- Power LED, form KEYLOCK
- Hard Drive activity LED, IDE LED
- System Speaker, SPEAKER
- Soft-touch button power on/off, SW ON
- External power saving control, EXTSMI (optional)

The connector pin out are described as the figure below:

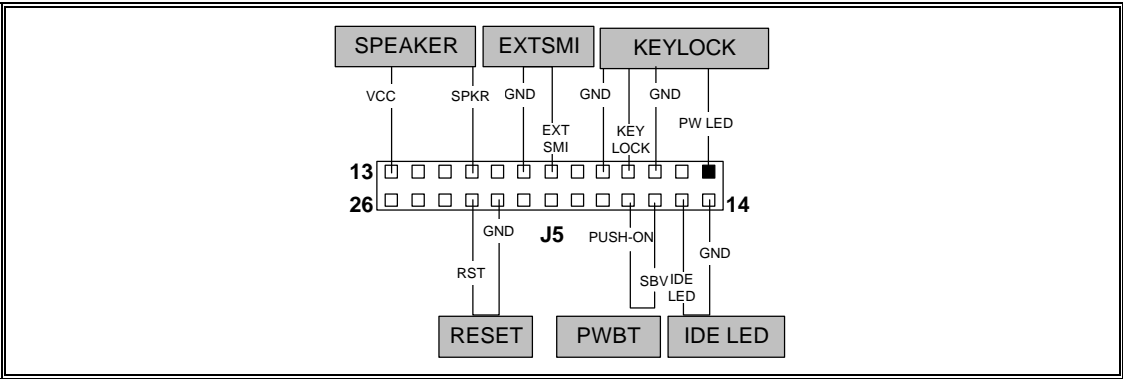

The Onboard Function Connector Pin Out

Integrated USB, Infra-Red and PS/2 Mouse connector

The total of two USB device connectors, a PS/2 mouse, and an Infrared devices are all allocated at this connector (JP15).

- Pin1 to Pin5 for USB1 connector
- Pin11 to Pin15 for USB2 connector
- Pin6 to Pin10 for PS/2 connector
- Pin16 to Pin20 InfraRed connector

The connector pin out signal definitions are described as the table below:

Pin	Signal Name	Pin	Signal Name
1 (USB1)	USB +5 Volt	11 (USB2)	USB +5 Volt
2	USB Port 1-	12	USB Port 2-
3	USB Port 1+	13	USB Port 2+
4	Ground	14	Ground
5	No Connect	15	No Connect
6 (PS/2 Mouse)	PS/2 Data	16 (IR)	+5V
7	PS/2 Clock	17	No Connect
8	Ground	18	Infrared Receive
9	No Connect	19	Ground
10	+5V	20	Infrared Transmit

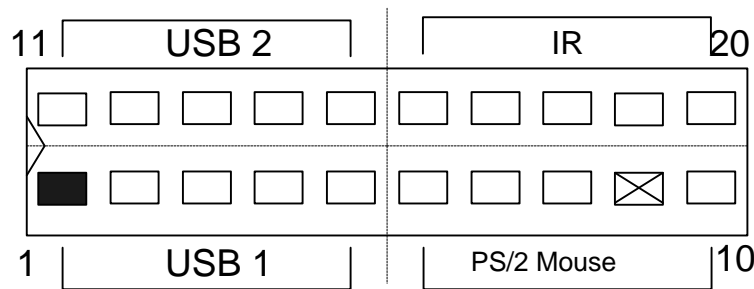

REPLACING BATTERY

A 3V, CR-2030, Lithium battery is installed on the on-board battery socket. This battery is used to supply the CMOS RAM backup power during system powered-off. Danger of explosion if battery is incorrectly replaced. Therefore, if you have any difficulties, please consult to the technical personnel.

Quick Installation Guide

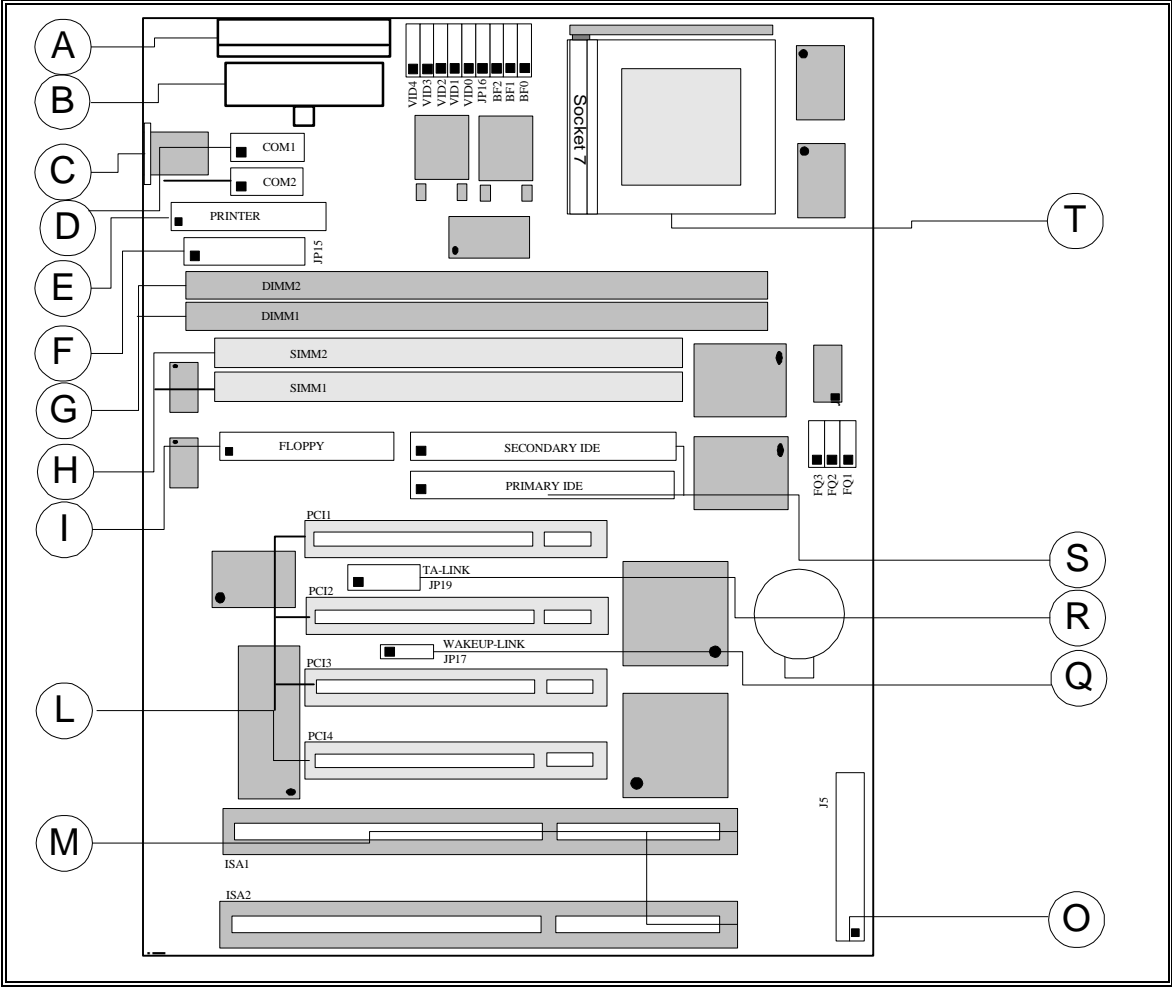

TX98

TX98

- A. AT Power Supply Connector
- B. ATX Power Supply Connector
- C. AT Keyboard Connector
- D. Serial (COM1 and 2) Headers
- E. Parallel (Printer) Port Header
- F. Integrated Functions Connector
- G. 3.3v DIMM Sockets

- H. SIMM RAM Sockets
- I. Floppy Drive Connector

- L. PCI Bus Connector
- M. ISA Bus Connectors

- O. Front Panel Connector
- P. TC-LINK SCSI Header
- Q. WAKEUP-LINK Header

- R. TA-LINK Intel LAN Header
- S. IDE Connectors
- T. Pentium Socket 7

“Auto Jumper Yes” Guide

- To enable the “Auto Jumper Yes”, the onboard jumper **JP16** must be shorted (**1-2**). Then, the CPU brand and its core voltage will be automatically detected. But one thing to remember is the CPU speed is necessary to select a suitable one at the CMOS setup. Or, if **JP16** is shorted (**2-3**), that means you should follow the jumper table (at the next page) to set up your CPU settings manually. On the other hand, pressing the key “**F**” to clear the CMOS setting and “**J**” to re-detect the CPU setting during power up your system.

“CPU Voltage Selection”

- The voltage regulator will automatically detect and switch between **Single Power Plane** & **Dual Power Planes**.

INTEL PENTIUM P54C/P55C CPU

Internal CPU Speed (MHz)	External Bus Speed (MHz)	FQ3	FQ2	FQ1	Frequency Ratio	BF2	BF1	BF0
100	66	[1-2]	[1-2]	[1-2]	1.5x	1-2	1-2	1-2
120	60	[1-2]	[1-2]	[2-3]	2.0x	1-2	1-2	2-3
133	66	[1-2]	[1-2]	[1-2]	2.0x	1-2	1-2	2-3
150	60	[1-2]	[1-2]	[2-3]	2.5x	1-2	2-3	2-3
166	66	[1-2]	[1-2]	[1-2]	2.5x	1-2	2-3	2-3
200	66	[1-2]	[1-2]	[1-2]	3.0x	1-2	2-3	1-2
233	66	[1-2]	[1-2]	[1-2]	3.5x	1-2	1-2	1-2

CYRIX/IBM 6x86 M1/M2 CPU

P150+	60	[1-2]	[1-2]	[2-3]	2.0x	1-2	1-2	2-3
P166+	66	[1-2]	[1-2]	[1-2]	2.0x	1-2	1-2	2-3
PR200	75	[1-2]	[2-3]	[1-2]	2.0x	1-2	1-2	2-3
PR233	66	[1-2]	[1-2]	[1-2]	3.0x	1-2	2-3	1-2
PR233	75	[1-2]	[2-3]	[1-2]	2.5x	1-2	2-3	2-3
PR266	66	[1-2]	[1-2]	[1-2]	3.5x	1-2	1-2	1-2
PR300	66	[1-2]	[1-2]	[1-2]	3.5x	1-2	1-2	1-2
PR300	75	[1-2]	[2-3]	[1-2]	3.0x	1-2	2-3	1-2
PR333	75	[1-2]	[2-3]	[1-2]	3.5x	1-2	1-2	1-2
PR333	83	[2-3]	[1-2]	[2-3]	3.0x	1-2	2-3	1-2

AMD-K5/K6 CPU

PR100	66	[1-2]	[1-2]	[1-2]	1.5x	1-2	1-2	1-2
PR166/K6-166	66	[1-2]	[1-2]	[1-2]	2.5x	1-2	2-3	2-3
PR200	66	[1-2]	[1-2]	[1-2]	3.0x	1-2	2-3	1-2
PR233	66	[1-2]	[1-2]	[1-2]	3.5x	1-2	1-2	1-2
PR266	66	[1-2]	[1-2]	[1-2]	4.0x	2-3	1-2	2-3
PR300	66	[1-2]	[1-2]	[1-2]	4.5x	2-3	2-3	2-3
PR333	66	[1-2]	[1-2]	[1-2]	5.0x	2-3	2-3	1-2

IDT-C6

150	50	[2-3]	[2-3]	[2-3]	3.0x	1-2	2-3	1-2
150	75	[1-2]	[2-3]	[1-2]	2.0x	1-2	1-2	2-3
180	60	[1-2]	[1-2]	[2-3]	3.0x	1-2	2-3	1-2
200	66	[1-2]	[1-2]	[1-2]	3.0x	1-2	2-3	1-2
225	75	[1-2]	[2-3]	[1-2]	3.0x	1-2	2-3	1-2

CPU Voltage Selection

CPU type	Voltage Requirements
Intel Pentium P54C, Cyrix/IBM M1 6x86, AMD-K5, IDT-C6	3.4V (STD) / 3.5V (VRE)
Intel Pentium P55C, Cyrix/IBM M1 6x86L	2.8V
Cyrix/IBM 6x86MX, MII, K6-PR166/200	2.9V
AMD-K6-PR233	3.2V
AMD-K6-PR266, PR300	2.2V



CPU Core Voltage Table

Vcore	VID4	VID3	VID2	VID1	VID0
2.2V	1-2	1-2	1-2	2-3	1-2
2.8V	1-2	2-3	1-2	1-2	1-2
2.9V	1-2	2-3	1-2	1-2	2-3
3.2V	1-2	2-3	2-3	1-2	1-2
3.3V	1-2	2-3	2-3	1-2	2-3
3.4V	1-2	2-3	2-3	2-3	1-2
3.5V	1-2	2-3	2-3	2-3	2-3

Bus Frequency Ratio

Ratio	BF2	BF1	BF0
2.0x	1-2	1-2	2-3
2.5x	1-2	2-3	2-3
3.0x	1-2	2-3	1-2
3.5x / 1.5x	1-2	1-2	1-2
4.0x	2-3	1-2	2-3
4.5x	2-3	2-3	2-3
5.0x	2-3	2-3	1-2
5.5x	2-3	1-2	1-2

Quick Reference of Your Motherboard

[A] AT Power Supply Connector

Based on the AT specification, one 12-pin power connector covers all the required power sources, $\pm 5V$ and $\pm 12V$.

[B] ATX Power Supply Connector

Based on the ATX specifications, one 20-pin power connector covers all the required power sources, $\pm 5V$, $\pm 12V$, and $\pm 3.3V$, with soft-touch button power on/off features. This connector reduces the installation time and minimizes the chance of defects caused by incorrect connection.

[C] AT Keyboard Connector

This connection is used for a standard IBM-compatible keyboard, such as 101 enhanced keyboard.

[D] Serial (COM 1 and 2) Port Headers

This motherboard provides two high-speed UART compatible serial ports.

[E] Parallel (Printer) Port Connector

One Parallel port with SPP, EPP and ECP capabilities.

[F] Integrated Functions Connector

- I) From Pin1 to Pin5 is the first USB device "USB1" and Pin11 to Pin15 is the second USB device "USB2" connector. Universal Serial Bus (USB) is new interface standard for any I/O device "Outside the Box". USB makes your peripherals have a real plug and play (PnP) capabilities with up to 12MB/sec data speed In the coming soon, any external device connected to your computer will be standardized into USB standard which are all have a special 4-pin rectangle shape connector. Therefore, with the Intel chipset, this motherboard builds two USB headers on-board for you future investment. If you are using an USB device, you must purchase an optional USB connector.
- II) From Pin6-10 is the PS/2 device, likes some PS/2 keyboard and mouse, are all have a standard 6-pin round shape connector. However, it does not have a unique onboard standard. Therefore, please refer to the Chapter "Motherboard Installation", in order to purchase an suitable PS/2 Mouse Connector.
- III) From Pin16-20 is a 5-pin interface on the front panel I/O connector is provided to allow connection to a Hewlett Packard HSDSL-1000 compatible Infra-red (IrDA) transmitter/receiver. Once the module is connected to the front panel I/O header, Serial port 2 can be re-directed to the IrDA module. When configured for IrDA, the user can transfer files to or from portable devices such as laptops, PDA's and printers using application software such as LapLink. The IrDA specification provides for data transfers at 115kbps from a distance of 1 meter. Support for Consumer Infra Red (ASK-IR) is also included, please refer to your IR equipment for more detailed information.

[G] SDRAM Socket

There are two unbuffered, 3.3 Volts, SDRAM socket on-board provides more flexibility for your system memory upgrade.

[H] SIMM Sockets

This motherboard provides two 72-pin SIMM sockets. The minimum memory size is 8 MB by using two 1M x 32 SIMM modules and maximum memory size is 128 MB by four 8M x 32 SIMM modules. Memory timing can be configured through the BIOS setup, please refer to the chapter of BIOS setup. They support both Fast Page Mode and Extended Date Output (EDO) SIMM RAM. Both parity and non-parity memory are supported.

NOTICE

Due to the electrical loading characteristics, 64 MB SIMMs using the 16 MB technology are not supported by this motherboard. 64 MB SIMMs using 64 MB technology will be supported by the motherboard when they become available, depending on the characteristics of the memory module.



EDO DRAM

Extended Data Out (or Hyper Page) DRAM is designed to improve the DRAM read performance. EDO DRAM holds the memory data valid until the next memory access cycle, unlike standard fast page mode DRAM that tri-states the memory data when the pre-charge cycle occurs, prior to the next memory access cycle. EDO DRAM timings are X-2-2-2 compared to FPM timings of X-3-3-3

[I] Floppy Drive Connector

A 34-pin connector on-board allows connection to two 360K, 720K, 1.2M, 1.44, 2.88M floppy disk drives.

[L] PCI Add-in Board Connectors

This motherboard provides four full-length 32-bits PCI slots with up to 133MB/sec burst data transfer rate.

[M] ISA Add-in Board Connectors

This motherboard provides two 16-bits ISA slot which allows backward hardware compatibility.

[O] Front Panel Function Connector

For you convenience, all the front panel functions are integrated into a single connector, which included power LED and keyboard lock, turbo switch, reset switch, SMI switch and speaker.

[Q] WAKEUP-LINK Interface

This header is used to connect an add-in NIC (Network Interface Card) which has WOL capability to a motherboard.

[R] TA-LINK Intel LAN Header

This header interface supporting E100+ PCI LAN Card using Intel LAN chip.

[S] IDE Connectors

This motherboard have two independent high performance bus-mastering PCI IDE interfaces capable of supporting up to UltraDMA-33 devices. The system BIOS supports automatic detection of the IDE device data transfer rate and translation between different kinds of device mode such as Logical Block Addressing (LBA) and Extended Cylinder Sector Head (ECSH) translation modes and ATAPI (e.g., CD-ROM) devices on both IDE interfaces.

In a true multi-tasking operating systems like Windows® 95 and Windows® NT, the IDE interface can operate as a PCI bus master capable of supporting Ultra DMA-33 devices with transfer rates of up to 33MB/sec.

[T] Pentium® Type-7 Socket

The type-7 socket is a 321-pins, zero insertion force (ZIF) socket. It provides users with a performance upgrade path to Pentium® OverDrive technology.



PENTIUM® PROCESSOR

An approved Pentium heatsink is necessary for proper thermal dissipation in an AT compliant chassis. The processor/heatsink assembly must be securely fastened to the Socket 7 ZIF socket by two clips. These clips fit over the heatsink assembly and attach to the outer wide tabs of the Socket 7 assembly.

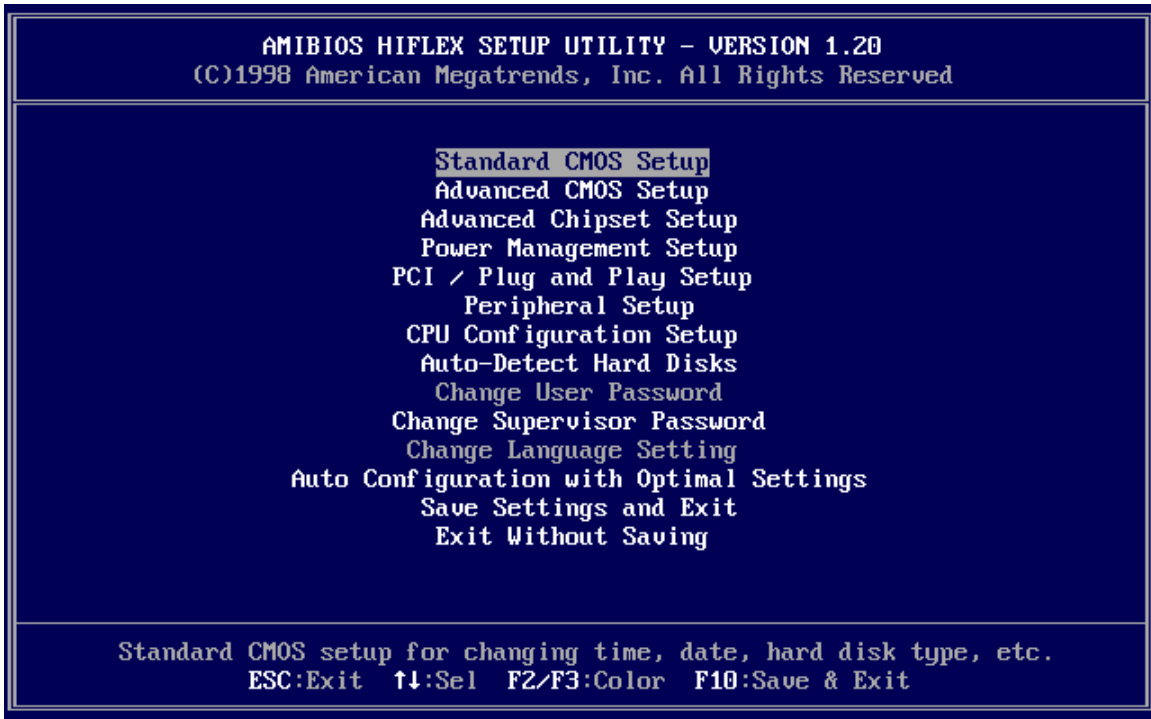

AMIBIOS Setup

Types of Setup	Description
Standard CMOS Setup	Sets time, date, hard disk type, types of floppy drives, monitor type, and if keyboard is installed.
Advanced CMOS Setup	Sets Typematic Rate and Delay, Above 1 MB Memory Test, Memory Test Tick Sound, Hit Message Display, System Boot Up Sequence, and many others.
Advanced Chipset Setup	Sets chipset-specific options and features.
Power Management Setup	Controls power conservation options.
PCI/PnP Setup	Sets options related to PCI bus and Plug and Play options.
Peripheral Setup	Controls I/O Controller-related options.
CPU Configuration Setup	This option selects the type of CPU install in the motherboard. The settings are <i>Auto</i> (AMIBIOS automatically determines the CPU type).

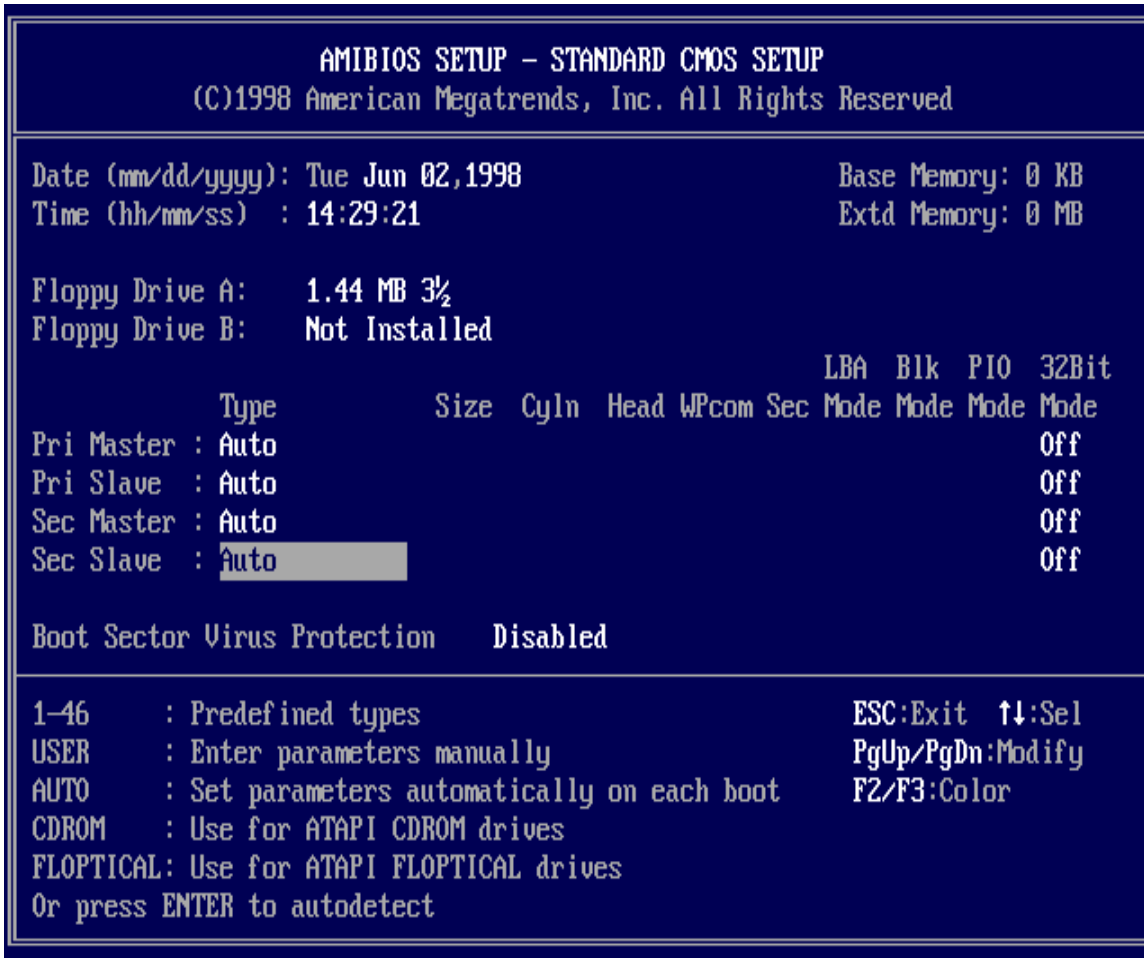

Standard CMOS Setup

Select the AMIBIOS Setup options by choosing Standard Setup from the AMIBIOS Setup main menu. Standard Setup options are described below.

Floppy Drive A: and B:

Move the cursor to these fields via ↑ and ↓ and select the floppy type. The settings are 360 KB 5¼ inch, 1.2 MB 5¼ inch, 720 KB 3½ inch, 1.44 MB 3½ inch, or 2.88 MB 3½ inch.

Primary Master

Primary Slave

Secondary Master

Secondary Slave

Select these options to configure the drive named in the option. Select *Auto Detect IDE* to let AMIBIOS automatically configure the drive. A screen with a list of drive parameters appears. Click on *OK* to configure the drive.

Type	How to Configure
SCSI	Select <i>Type</i> . Select <i>Not Installed</i> on the drive parameter screen. The SCSI drivers provided by the SCSI manufacturer should allow you to configure the SCSI drive.
IDE	Select <i>Type</i> . Select <i>Auto</i> to let AMIBIOS determine the parameters. Click on <i>OK</i> when AMIBIOS displays the drive parameters. Select <i>LBA Mode</i> . Select <i>On</i> if the drive has a capacity greater than 540 MB. Select <i>Block Mode</i> . Select <i>On</i> to allow block mode data transfers. Select <i>32-Bit Mode</i> . Select <i>On</i> to allow 32-bit data transfers. Select the <i>PIO Mode</i> . It is best to select <i>Auto</i> to allow AMIBIOS to determine the PIO mode. If you select a PIO mode that is not supported by the IDE drive, the drive will not work properly. If you are absolutely certain that you know the drive's PIO mode, select PIO mode 0 - 4, as appropriate.
CD-ROM	Select <i>Type</i> . Select <i>CDROM</i> . Click on <i>OK</i> when AMIBIOS displays the drive parameters.
Standard MFM	Select <i>Type</i> . You must know the drive parameters. Select the drive type that exactly matches your drive's parameters.
Non-Standard MFM	Select <i>Type</i> . If the drive parameters do not match the drive parameters listed for drive types 1 - 46, select <i>User</i> and enter the correct hard disk drive parameters.

Entering Drive Parameters

You can also enter the hard disk drive parameters. The drive parameters are:

Parameter	Description
Type	The number for a drive with certain identification parameters.
Cylinders	The number of cylinders in the disk drive.
Heads	The number of heads.
Write Precompensation	The actual physical size of a sector gets progressively smaller as the track diameter diminishes. Yet each sector must still hold 512 bytes. Write precompensation circuitry on the hard disk compensates for the physical difference in sector size by boosting the write current for sectors on inner tracks. This parameter is the track number on the disk surface where write precompensation begins.
Landing Zone	This number is the cylinder location where the heads normally park when the system is shut down.
Sectors	The number of sectors per track. MFM drives have 17 sectors per track. RLL drives have 26 sectors per track. ESDI drives have 34 sectors per track. SCSI and IDE drives have even more sectors per track.
Capacity	The formatted capacity of the drive is the number of heads times the number of cylinders times the number of sectors per track times 512 (bytes per sector).

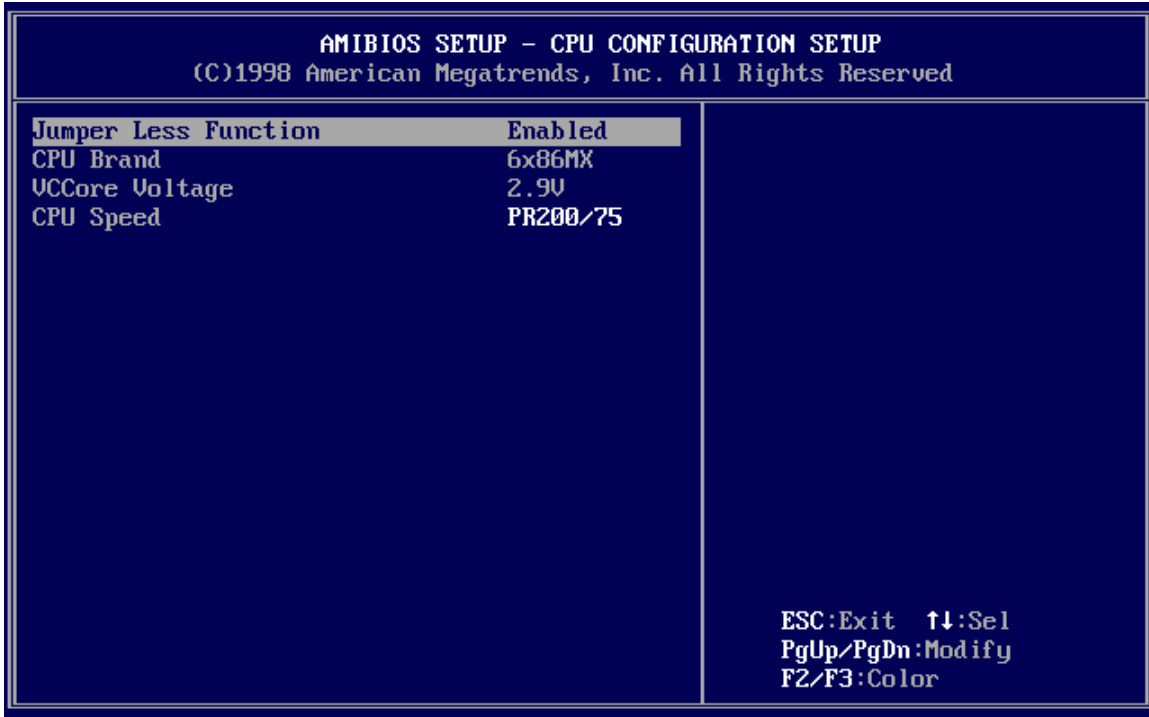

CPU CONFIGURATION SETUP

The system BIOS is capable to detect the CPU type, say, Pentium II or Celeron. The user is only required to select the CPU speed. In addition, **overclocking** option is provided for advanced users who prefer to run the CPU over the specified clock frequency of 66MHz.

AMIBIOS SETUP - ADVANCED CMOS SETUP		
(C)1998 American Megatrends, Inc. All Rights Reserved		
1st Boot Device	FLOPPY	Available Options:
2nd Boot Device	IDE-0	Disabled
3rd Boot Device	CDROM	IDE-0
4th Boot Device	Disabled	IDE-1
Boot From Network Card	Yes	IDE-2
Try Other Boot Devices	Yes	IDE-3
S.M.A.R.T. for Hard Disks	Disabled	▶ FLOPPY
Quick Boot	Enabled	LS-120
BootUp Num-Lock	On	CDROM
Floppy Drive Swap	Disabled	SCSI
Floppy Drive Seek	Enabled	
Floppy Access Control	Normal	
HDD Access Control	Normal	
PS/2 Mouse Support	Enabled	
Primary Display	UGA/EGA	
Password Check	Setup	
Boot To OS/2	No	
External Cache	Enabled	ESC:Exit ↑↓:Sel
System BIOS Cacheable	Enabled	PgUp/PgDn:Modify
UGA BIOS Cacheable	Enabled	F2/F3:Color

ADVANCED CMOS SETUP

- Quick Boot** Set this option to *Enabled* to instruct AMIBIOS to boot quickly when the computer is powered on. This option replaces the old **Above 1 MB Memory Test** Advanced Setup option. The settings are:
- 1st Boot Device** This option sets the type of device for the first boot drives that the AMIBIOS attempts to boot from after AMIBIOS POST completes. The settings are *Disabled, Network, Floptical, SCSI, CDROM, IDE-0, IDE-1, IDE-2, or IDE-3*. The Optimal and Fail-Safe default settings are *IDE-0*
- 2nd Boot Device** This option sets the type of device for the second boot drives that the AMIBIOS attempts to boot from after AMIBIOS POST completes. The settings are *Disabled, Floppy, or IDE-0*. The Optimal and Fail-Safe default settings are *Floppy*.
- 3rd Boot Device** This option sets the type of device for the third boot drives that the AMIBIOS attempts to boot from after AMIBIOS POST completes. The settings are *Disabled, CD-ROM, or IDE-0*. The Optimal and Fail-Safe default settings are *CD-ROM*.

Try Other Boot Devices Set this option to *Yes* to instruct AMIBIOS to attempt to boot from any other drive in the system if it cannot find a boot drive among the drives specified in the **1st Boot Device**, **2nd Boot Device**, **3rd Boot Device** options.

Floppy Access Control This option specifies the read/write access that is set when booting from a floppy drive. The settings are *Read/Write* or *Read-Only*. The Optimal and Fail-Safe default settings are *Read/Write*.

Hard Disk Access Control This option specifies the read/write access that is set when booting from a hard disk drive. The settings are *Read/Write* or *Read-Only*. The Optimal and Fail-Safe default settings are *Read/Write*.

S.M.A.R.T. For Hard Disks Set this option to *Enabled* to permit AMIBIOS to use the SMART (System Management System Management and Reporting Technologies) protocol for reporting server system information over a network. The settings are *Enabled/Disabled*. The Optimal and Fail-Safe default settings are *Disabled*.

Boot Up Num Lock Set this option to *Off* to turn the Num Lock key off when the computer is booted so you can use the arrow keys on both the numeric keypad and the keyboard. The settings are *On* or *Off*. The default settings are *On*.

PS/2 Mouse Support Set this option to *Enabled* to enable AMIBIOS support for a PS/2-type mouse. Pins 2-3 of the PS/2 Mouse Selector jumper on the motherboard must be shorted together to enable PS/2 mouse support. The settings are *Enabled* or *Disabled*. The Optimal and Fail-Safe default settings are *Enabled*.

Primary Display This option configures the type of monitor attached to the computer. The settings are *Mono*, *CGA40x25*, *CGA80x25*, *VGA/EGA*, or *Absent*. The Optimal and Fail-Safe default settings are *VGA/EGA*.

Password Check This option enables password checking every time the system boots or when you run AMIBIOS Setup. If *Always* is chosen, a user password prompt appears every time the computer is turned on. If *Setup* is chosen, the password prompt appears if AMIBIOS is executed. See Advanced Setup chapter for instructions on changing a password. The Optimal and Fail-Safe defaults are *Setup*.

Boot To OS/2 Set this option to *Enabled* if running OS/2 operating system and using more than 64 MB of system memory on the motherboard. The settings are *Enabled* or *Disabled*. The Optimal and Fail-Safe default settings are *Disabled*.

CPU Microcode Update Set this option to *Enabled* to permit the CPU to be updated online at any time. The settings are *Enabled* or *Disabled*. The Optimal and Fail-Safe default settings are *Enabled*.

System BIOS Cacheable When set to *Enabled*, the contents of the F0000h system memory segment can be read from or written to cache memory. The contents of this memory segment are always copied from the BIOS ROM to system RAM for faster execution. The settings are *Enabled* or *Disabled*. The Optimal default setting is *Enabled*. The Fail-Safe default setting is *Disabled*.

C000,16K Shadow

C400,16K Shadow

These options specify how the 32 KB of video ROM at C0000h is treated. The settings are:

Setting	Description
<i>Disabled</i>	The contents of the video ROM are not copied to RAM.
<i>Enabled</i>	The contents of the video ROM area from C0000h - C7FFFh are copied (shadowed) from ROM to RAM for faster execution.
<i>Cached</i>	The contents of the video ROM area from C0000h - C7FFFh are copied from ROM to RAM and can be written to or read from cache memory.

The Optimal and Fail-Safe default settings are *Cached*.

C800,16K Shadow

CC00,16K Shadow

D000,16K Shadow

D400,16K Shadow

D800, 16K Shadow

DC00,16K Shadow

These options enable shadowing of the contents of the ROM area named in the option. The ROM area not used by ISA adapter cards is allocated to PCI adapter cards. The settings are:

Setting	Description
<i>Disabled</i>	The contents of the video ROM are not copied to RAM.
<i>Cached</i>	The contents of the video ROM area from C0000h - C7FFFh are copied from ROM to RAM and can be written to or read from cache memory.
<i>Enabled</i>	The contents of the video ROM area from C0000h - C7FFFh are copied (shadowed) from ROM to RAM for faster execution.

The Optimal and Fail-Safe default settings are *Cached*.



ADVANCED Chipset Setup

The AMIBIOS Setup options described in this section are selected by choosing Advanced Chipset Setup from the AMIBIOS Setup main menu.

Memory Holes

This option enables or disables the memory hole. Memory holes are the region in memory forwarded to ISA/PCI bus instead of memory bus. The settings are *None*, *15M-16M (1M)* and *14M-16M(2M)*. This feature will be useful for some operating systems like UNIX. The optimal and fail-safe default settings are *None*.

Sustained 3T Write

Set this option to *Enabled* to enable the sustained 3T write logic for write through cache. The settings are *Enabled* or *Disabled*. The optimal and fail-safe default settings are *Disabled*.

Linear Burst

Set this option to *Enabled* to enable linear burst cache mode for Cyrix CPUs. This option is only valid for Cyrix CPU. The settings are *Enabled* or *Disabled*. The optimal and fail-safe default settings are *Disabled*.

CAS Latency

This option is used to set the CAS latency timing for SDRAM DRAM. This setting is valid only for SDRAM DIMM. The settings are *2CL* or *3CL*. The optimal and fail-safe

default settings are *3CL*.

Bank Interleave

Set this option to *Enabled* to enable DRAM banks interleave logic. The settings are *Enabled* or *Disabled*. The optimal and fail-safe default settings are *Enabled*.

DRAM Timing Control

This option is used set DRAM timing of the chipset. For user convenience the options are specified as *Normal*, *Medium*, *Fast* and *Turbo*. The optimal and fail-safe default settings are *Normal*.

DRAM Pipeline

This option is used to enable or disable DRAM read and write pipeline logic. The settings are *Enabled* or *Disabled*. The optimal and fail-safe default settings are *Enabled* and *Disabled* respectively.

CPU to PCI Write Buffer

This option is used to enable or disable CPU to PCI write buffer logic. The settings are *Enabled* or *Disabled*. The optimal and fail-safe default settings are *Enabled* and *Disabled* respectively.

PCI Dynamic Bursting

This option is used to enable or disable PCI dynamic bursting logic in the chipset. The settings are *Enabled* or *Disabled*. The optimal and fail-safe default settings are *Enabled* and *Disabled* respectively.

PCI Burst

This option is used to enable or disable PCI burst logic in the chipset. The settings are *Enabled* or *Disabled*. The optimal and fail-safe default settings are *Enabled* and *Disabled* respectively.

Quick Frame Generation

This option is used to enable or disable quick frame generation logic. The settings are *Enabled* or *Disabled*. The optimal and fail-safe default settings are *Enabled* and *Disabled* respectively.

PCI Master 1 WS Write

This option is used to enable or disable PCI master 1 wait state write logic in the chipset. The settings are *Enabled* or *Disabled*. The optimal and fail-safe default settings are *Disabled*.

PCI Peer Concurrency

This option is used to enable or disable PCI peer concurrency logic in the chipset. The settings are *Enabled* or *Disabled*. The optimal and fail-safe default settings are *Disabled*.

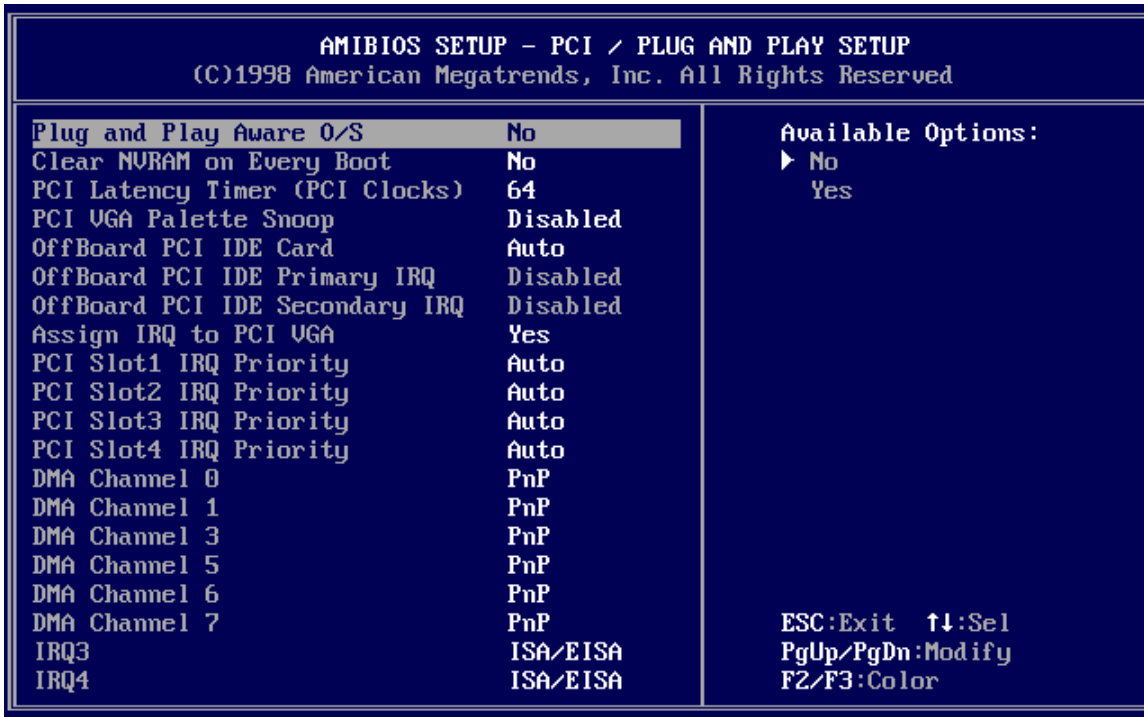

PCI/PnP Setup

Choose PCI/Plug and Play Setup from the AMIBIOS Setup screen to display the PCI and Plug and Play Setup options, described below.

Plug and Play Aware O/S

Set this option to *Yes* to inform AMIBIOS that the operating system can handle plug and Play (PnP) devices. The settings are *No* or *Yes*. The Optimal and Fail-Safe default settings are *No*.

PCI Latency Timer (PCI Clocks)

This option specifies the latency timings (in PCI clocks) for PCI devices installed in the PCI expansion slots. The settings are *32, 64, 96, 128, 160, 192, 224, or 248*. The Optimal and Fail-Safe default settings are *64*.

PCI VGA Palette Snoop When this option is set to *Enabled*, multiple VGA devices operating on different buses can handle data from the CPU on each set of palette registers on every video device. Bit 5 of the command register in the PCI device

configuration space is the VGA Palette Snoop bit (0 is disabled). For example:
if there are two VGA devices in the computer (one PCI and one ISA) and:

VGA Palette Snoop Bit	Action
<i>Disabled</i>	Data read and written by the CPU is only directed to the PCI VGA device's palette registers.
<i>Enabled</i>	Data read and written by the CPU is directed to the both the PCI VGA device's palette registers and the ISA VGA device palette registers, permitting the palette registers of both devices to be identical.

This option must be set to *Enabled* if any ISA adapter card installed in the system requires VGA palette snooping. The Optimal and Fail-Safe default settings are *Disabled*.

Allocate IRQ To PCI VGA Set this option to *Yes* to allocate an IRQ to the VGA device on the PCI bus. The settings are *Yes* or *No*. The Optimal and Fail-Safe default settings are *Yes*.

PCI IDE Bus Master Set this option to *Enabled* to specify that the IDE controller on the PCI bus has bus mastering capability. The settings are *Disabled* or *Enabled*. The Optimal and Fail-Safe default settings are *Disabled*.

Offboard PCI IDE Card This option specifies if an offboard PCI IDE controller adapter card is used in the computer. You must also specify the PCI expansion slot on the motherboard where the offboard PCI IDE controller card is installed. If an offboard PCI IDE controller is used, the motherboard onboard IDE controller is automatically disabled. The settings are *Disabled*, *Auto*, *Slot1*, *Slot2*, *Slot3*, *Slot4*, *Slot5*, or *Slot6*. If *Auto* is selected, AMIBIOS automatically determines the correct setting. The Optimal and Fail-Safe default settings are *Auto*. This option forces IRQ 14 and 15 to a PCI slot on the PCI local bus. This is necessary to support non-compliant PCI IDE adapter cards.

Offboard PCI IDE Primary IRQ This option specifies the PCI interrupt used by the primary IDE channel on the offboard PCI IDE controller. The settings are *Disabled*, *Hardwired*, *INTA*, *INTB*, *INTC*, or *INTD*. The Optimal and Fail-Safe default settings are *Disabled*.

Offboard PCI IDE Secondary IRQ This option specifies the PCI interrupt used by the secondary IDE channel on the offboard PCI IDE controller. The settings are *Disabled*, *Hardwired*, *INTA*, *INTB*, *INTC*, or *INTD*. The Optimal and Fail-Safe settings are *Disabled*.

PCI Slot1 IRQ Priority

PCI Slot2 IRQ Priority

PCI Slot3 IRQ Priority

PCI Slot4 IRQ Priority

These options specify the IRQ priority for PCI devices installed in the PCI expansion slots. The settings are *Auto*, (*IRQ*) *3, 4, 5, 7, 9, 10*, and *11*, in priority order. The Optimal and Fail-Safe default settings are *Auto*.

DMA Channel 0

DMA Channel 1

DMA Channel 3

DMA Channel 5

DMA Channel 6

DMA Channel 7

These options allow you to specify the bus type used by each DMA channel. The settings are *PnP* or *ISA/EISA*. The Optimal and Fail-Safe default settings are *PnP*.

IRQ3

IRQ4

IRQ5

IRQ7

IRQ9

IRQ10

IRQ11

IRQ12

IRQ14

IRQ15

These options specify the bus that the specified IRQ line is used on. These options allow you to reserve IRQs for legacy ISA adapter cards. These options determine if AMIBIOS should remove an IRQ from the pool of available IRQs passed to devices that are configurable by the system BIOS. The available IRQ pool is determined by reading the ESCD NVRAM. If more IRQs must be removed from the pool, the end user can use these options to reserve the IRQ by assigning an *ISA/EISA* setting to it. Onboard I/O is configured by AMIBIOS. All IRQs used by onboard I/O are configured as *PCI/PnP*.

IRQ12 only appears if the **Mouse Support** option in Advanced Setup is set to *Disabled*. IRQ14 and 15 will not be available if the onboard PCI IDE is enabled. If all IRQs are set to *ISA/EISA* and IRQ14 and 15 are allocated to the onboard PCI IDE, IRQ9 will still be available for PCI and PnP devices, because at least one IRQ must be available for PCI and PnP devices. The settings are *ISA/EISA* or *PCI/PnP*. The Optimal and Fail-Safe default settings are *PCI/PnP*.

Reserved Memory Size

This option specifies the size of the memory area reserved for legacy ISA adapter cards. The settings are *Disabled*, *16K*, *32K*, or *64K*. The Optimal and Fail-Safe default settings are *Disabled*.

Reserved Memory Address

This option specifies the beginning address (in hex) of the reserved memory area. The specified ROM memory area is reserved for use by legacy ISA adapter cards.

This option does not appear if the **Reserved Memory Size** option is set to *Disabled*.

The settings are *C0000*, *C4000*, *C8000*, *CC000*, *D0000*, *D4000*, *D8000*, or *DC000*. The Optimal and Fail-Safe default settings are *N/A*.

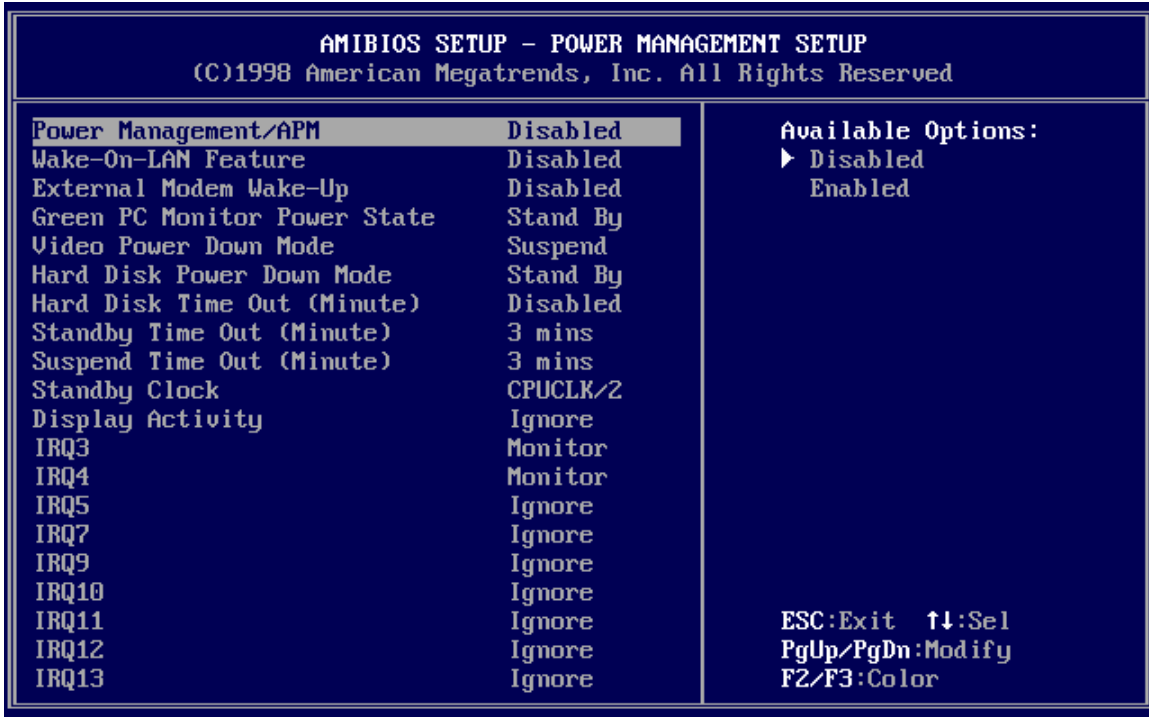

POWER MANAGEMENT SETUP

The AMIBIOS Setup options described in this section are selected by choosing Power Management Setup from the AMIBIOS Setup main menu.

- Power Management/APM** Set this option to *Enabled* to enable the chipset power management and APM (Advanced Power Management) features. The settings are *Enabled* or *Disabled*. The Optimal and Fail-Safe default settings are *Disabled*.
- Wake-On-LAN Feature** Set this option to *Enabled* to enable the Wake-On-LAN features. The settings are *Enabled* or *Disabled*. The Optimal and Fail-Safe default settings are *Disabled*.
- External Modem Wake-Up** Set this option to *Enabled* to enable External Modem Wake-Up. The settings are *Enabled* or *Disabled*. The Optimal and Fail-Safe default settings are *Disabled*.

Green PC Monitor Power State This option specifies the power state that the green PC-compliant video monitor enters when AMIBIOS places it in a power saving state after the specified period of display inactivity has expired. The settings are *Off*, *Standby*, *Suspend*, or *Disabled*. The Optimal and Fail-Safe default settings are *Disabled*.

Video Power Down Mode This option specifies the power state that the video subsystem enters when AMIBIOS places it in a power saving state after the specified period of display inactivity has expired. The settings are *Standby*, *Suspend* or *Disabled*. The Optimal and Fail-Safe default settings are *Disabled*.

Hard Disk Power Down Mode This option specifies the power conserving state that the hard disk drive enters after the specified period of hard drive inactivity has expired. The settings are *Disabled*, *Standby*, or *Suspend*. The Optimal and Fail-Safe default settings are *Disabled*.

Hard Disk Timeout This option specifies the length of a period of hard disk drive inactivity. When this length of time expires, the computer enters power-conserving state specified in the **Hard Disk Power Down Mode** option (see the previous page). The settings are *Disabled*, *1 min. (minute)*, *2 min.*, *3 min.*, *4 min.*, *5 min.*, *6 min.*, *7 min.*, *8 min.*, *9 min.*, *10 min.*, *11 min.*, *12 min.*, *13 min.*, *14 min.*, and *15 min.* The Optimal and Fail-Safe default settings are *Disabled*.

Standby/Suspend Timer Unit This option specifies the unit of time used for the Standby and Suspend timeout periods. The settings are *4 msec*, *4 sec*, *32 sec*, or *4 min*. The Optimal and Fail-Safe default settings are *4 min*.

Standby Timeout This option specifies the length of a period of system inactivity while in Full power on state. When this length of time expires, the computer enters Standby power state. The settings are *Disabled*, *4 msec*, *8 msec*, *12 msec*, *16 msec*, *up to 508 msec*, *in increments of 4 msec*. The Optimal and Fail-Safe default settings are *Disabled*.

Suspend Timeout This option specifies the length of a period of system inactivity while in Standby state. When this length of time expires, the computer enters Suspend power state. The settings are *Disabled*, *4 msec*, *8 msec*, *12 msec*, *16 msec*, *up to 508 msec*, *in increments of 4 msec*. The Optimal and Fail-Safe default settings are *Disabled*.

Slow Clock Ratio This option specifies the speed at which the system clock runs in the Standby Mode power saving state. The settings are expressed as a percentage between the normal CPU clock speed and the CPU clock speed when the computer is in the power-conserving state. The settings are *0-12.5%*, *12.5-25%*, *25-37.5%*, *37.5-50%*, *50-62.5%*, *62.5-75%*, or *75-87.5%*. The Optimal and Fail-Safe default settings are *50-62.5%*.

Display Activity When set to *Monitor*, this option enables event monitoring on the video display. If set to *Monitor* and the computer is in a power saving state, AMIBIOS watches for display activity. The computer enters the Full On state if any activity occurs. AMIBIOS reloads the Standby and Suspend timeout timers if display activity occurs. The settings are *Monitor* or *Ignore*. The Optimal and Fail-Safe default settings are *Ignore*.

Device 6 (Serial Port 1)

Device 7 (Serial Port 2)

Device 8 (Parallel Port)

Device 5 (Floppy Disk)

Device 0 (Primary Master IDE)

Device 1 (Primary Slave IDE)

Device 2 (Secondary Master IDE)

Device 3 (Secondary Slave IDE)

When set to *Monitor*, these options enable event monitoring on the specified hardware interrupt request line. If set to *Monitor* and the computer is in a power saving state, AMIBIOS watches for activity on the specified IRQ line. The computer enters the Full On state if any activity occurs. AMIBIOS reloads the Standby and Suspend timeout timers if activity occurs on the specified IRQ line.

The settings for each of these options are *Monitor* or *Ignore*. The Optimal and Fail-Safe default settings are *Ignore*.

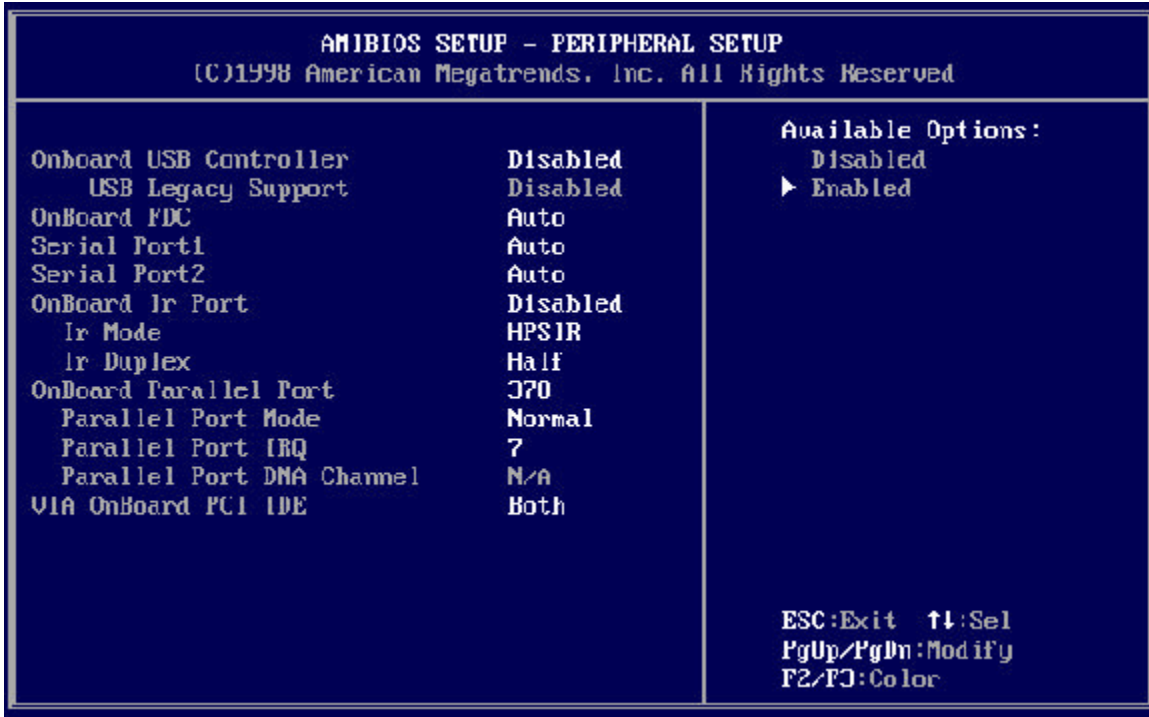

PERIPHERAL SETUP

Peripheral Setup options are displayed by choosing Peripheral Setup from the AMIBIOS Setup main menu. All Peripheral Setup options are described here.

USB Function Set this option to *Enabled* to enable USB (Universal Serial Bus) support. The settings are *Enabled* or *Disabled*.

USB Keyboard/Mouse Legacy Support

Set this option to *Enabled* to enable support for older keyboards and mouse devices if the **USB Function** option is set to *Enabled*. The settings are *Enabled* or *Disabled*.

Onboard IDE This option specifies the IDE channel used by the onboard IDE controller. The settings are *Disabled*, *Primary*, or *Secondary*.

Onboard Floppy Controller Set this option to *Enabled* to enable the floppy drive controller on the motherboard. The settings are *Auto* (*AMIBIOS automatically determines if the floppy controller should be enabled*), *Enabled*, or *Disabled*.

-
- Onboard Serial Port1** This option specifies the base I/O port address of serial port 1. The settings are *Auto* (AMIBIOS automatically determines the correct base I/O port address), *Disabled*, *3F8h*, *2F8h*, *2E8h*, or *3E8h*. The Optimal and Fail-Safe default settings are *Auto*.
-
- Onboard Serial Port2** This option specifies the base I/O port address of serial port 2. The settings are *Auto* (AMIBIOS automatically determines the correct base I/O port address), *Disabled*, *3F8h*, *2F8h*, *2E8h*, or *3E8h*. The Optimal and Fail-Safe default settings are *Auto*.
-
- Serial Port2 Mode** This option specifies the operating mode for serial port 2. This option only appears if the **Onboard Serial Port2** option is not set to **Auto** or **Disabled**. The settings are *IR* (infrared) or *Normal*. The Optimal and Fail-Safe default settings are *Normal*.
-
- IR Mode** This option specifies type of infrared devices supported by the system. This option only appears if the **Onboard Serial Port2** option is not set to **Auto** or **Disabled**. The settings are *Encoded* or *Non-Encoded*. There are no default settings.
-
- IR Duplex Mode** This option specifies the type of duplexing used for infrared on serial port 2. This option only appears if the **Onboard Serial Port2** option is not set to **Auto** or **Disabled**. The settings are *Half* or *Full*. There are no default settings.
-
- IR Transmitter** This option specifies the type of transmission used by the infrared devices attached to serial port 2. This option only appears if the **Onboard Serial Port2** option is not set to **Auto** or **Disabled**. The settings are *1.6 uS* or *3/16 Baud*. There are no default settings.
-
- Onboard Parallel Port** This option specifies the base I/O port address of the parallel port on the motherboard. The settings are *Disabled*, *378h*, *278h*, or *3BCh*. The Optimal default setting is *378h*.
-
- Parallel Port Mode** This option specifies the parallel port mode. The Optimal default setting is *Normal*. The Fail-Safe default setting is *Disabled*. The settings are:

Setting	Description
<i>Normal</i>	The normal parallel port mode is used.
<i>Bi-Dir</i>	Use this setting to support bidirectional transfers on the parallel port.
<i>EPP</i>	The parallel port can be used with devices that adhere to the Enhanced Parallel Port (EPP) specification. EPP uses the existing parallel port signals to provide asymmetric bidirectional data transfer driven by the host device.
<i>ECP</i>	The parallel port can be used with devices that adhere to the Extended Capabilities Port (ECP) specification. ECP uses the DMA protocol to achieve data transfer rates up to 2.5 Megabits per second. ECP provides symmetric bidirectional communication.

EPP Version This option specifies the Enhanced Parallel Port specification version number that is used in the system. This option only appears if the **Parallel Port Mode** option is set to *EPP*.

The settings are *1.7* or *1.9*. There are no Optimal and Fail-Safe default settings because the default setting for the **Parallel Port Mode** option is not *EPP*.

Parallel Port DMA Channel This option is only available if the setting for the **Parallel Port Mode** option is *ECP*. This option sets the DMA channel used by the parallel port. The settings are (*DMA Channel0*, *1*, or *3*). The Optimal and Fail-Safe default settings are not provided.

Parallel Port IRQ This option specifies the IRQ used by the parallel port. The settings are *Auto*, (*IRQ*) *5*, or (*IRQ*) *7*. The Optimal and Fail-Safe default settings are *Auto*.

SAVE AND EXIT SETUP

Select this option when you finished setup the CMOS and it will save the change you made and reboot the system after you press “YES”.

EXIT WITHOUT SAVING

If you decided not to save any change you had made, you can select this option to exit the CMOS setup and all the change you made will be ignored.

Motherboard Technical Specification

ENVIRONMENT

Parameter	Specification
Operating	
Temperature	+0°C to +55°C
Humidity	20% to 80%
Atmosphere	Non-condensing
Non-operating/Transportation	
Temperature	-20°C to +65°C
Humidity	10% to 90%
Atmosphere	Non-condensing
TX Power Supply Requirement	
±5 V	±5 %
±12 V	±5 %
Vibration	
Operating	0.2G Z axis (up and down), 5 to 300 Hz 0.1G X axis (front and rear), 5 to 300 Hz Y axis (left and right), 5 to 300 Hz

DIMENSIONS AND WEIGHT

Dimension Approx.	220 x 200 mm (8.5 x 8 inches)
Net Weight	0.46 Kg (1.05 lb.)

ELECTRICAL SPECIFICATION

Onboard Voltage Regulation	Under 3.3V condition
Voltage transient	± 5%
Set point variation	± 1%
Onboard Current Limitation	
Under 3.3V condition	about 14 Ampere (max.)

POWER CONSUMPTION

The board is designed to operate with 140-200 W AT power supply. For a system configured with the motherboard including a 200 MHz Pentium processor w/ 256 KB Cache, 64 MB EDO DRAM, 3.5-inch floppy drive, 2.1 GB IDE hard drive, 8X IDE CD-ROM, and a PCI graphics card, The overall calculated power dissipation is about 80W. However, this information is provided only as reference for the total system power usage.

Request For Technical Support

In order to provide you with effective and quick technical support, we need to know your system specification and environments. Please fill the following form as complete as possible so we can give you assistance.

PRODUCT INFORMATION	
MODEL	
CHIPSET MODEL	
RAM TYPE/SIZE/BRAND/SPEED	
BIOS VERSION	
PURCHASE DATE	
PROBLEM DESCRIPTION	
OPERATING SYSTEM	
APPLICATION SOFTWARE	
PROBLEM DESCRIPTION	

SYSTEM CONFIGURATION		
Display Card (Brand/Model)		
Resolution		
IDE Controller Card (Brand/Model)		
LAN Card (Brand/Model)		
Fax/Modem Card (Brand/Model)		
SCSI Controller (Brand/Model)		
Multi I/O Card (Brand/Model)		
Other Add-on Card (Brand/Model)		
IDE Disk Drive	PRIMARY MASTER (Brand/Model)	
	PRIMARY SLAVE (Brand/Model)	
	SECONDARY MASTER (Brand/Model)	
Floppy Drive	SECONDARY SLAVE (Brand/Model)	
	DRIVE A (Brand/Model)	
	DRIVE B (Brand/Model)	
Other Device (Brand/Model)		