



# **G5860PC**

**Rev. 0 +  
System Board  
User's Manual**



**- D28451130 -**





❖ **Copyright 1995 by DFI, Inc.**

*All rights reserved.*

*No part of this document may be copied, reproduced in any form or by any means or used to make any transformation/adaptation without the prior written consent of DFI, Inc.*

*DFI, Inc. makes no warranties with respect to this documentation and disclaims any implied warranties of merchantability, quality, or fitness for any particular purpose. The information in this document is subject to change without notice. DFI, Inc. reserves the right to make revisions to this publication and to make changes to any and/or all parts of its content, at any time, without obligation to notify any person or entity of such changes. Further, DFI, Inc. assumes no responsibility for any errors that may appear in this document.*

*DFI is a registered trademark, and G586OPC is a trademark of Diamond Flower, Inc. All other product names mentioned are trademarks or registered trademarks of their respective companies.*



## ❖ FCC Statement on Class B

*This equipment has been tested and found to comply with the limits for a Class B digital device, pursuant to Part 15 of the FCC rules. These limits are designed to provide reasonable protection against harmful interference when the equipment is operated in a residential installation. This equipment generates, uses and can radiate radio frequency energy and, if not installed and used in accordance with the instruction manual, may cause harmful interference to radio communications. However, there is no guarantee that interference will not occur in a particular installation. If this equipment does cause harmful interference to radio or television reception, which can be determined by turning the equipment off and on, the user is encouraged to try to correct the interference by one or more of the following measures:*

- *Reorient or relocate the receiving antenna.*
- *Increase the separation between the equipment and the receiver.*
- *Connect the equipment into an outlet on a circuit different from that to which the receiver is connected.*
- *Consult the dealer or an experienced radio TV technician for help.*

### **Notice:**

1. *The changes or modifications not expressly approved by the party responsible for compliance could void the user's authority to operate the equipment.*
2. *Shielded interface cables must be used in order to comply with the emission limits.*



## ❖ Table of Contents ❖

<b>Introduction .....</b>	<b>1</b>
Features and Specifications .....	2
Package Checklist .....	5
<b>Installation Overview .....</b>	<b>6</b>
Preparing the Area .....	6
Handling the System Board .....	7
Tips in Handling the System Board .....	7
Hardware Installation .....	8
Memory Installation .....	8
Installing the Modules .....	11
Board Configuration .....	12
Jumper Settings for Display Type and CMOS Clean .....	13
Jumper Settings for Super I/O Setting .....	15
Cache Configuration .....	17
Installing Asynchronous SRAM .....	17
Jumper Settings for Cache Memory .....	19
256KB Cache SRAM .....	20
512KB Cache SRAM .....	22
1MB Cache SRAM .....	24
Installing the Synchronous Cache Module .....	26
Jumper Settings .....	26
Installation .....	27
VRM Header .....	29
VRM Header and 3.3V Pentium Processor .....	29
VRM Header and Future Low-Voltage CPUs .....	30
CPU Installation .....	31
Jumper Settings for CPU .....	32
Jumpers JP3, JP4, JP9, JP10, JP18, JP19, JP20 JP21 and JP24 .....	41
Installing Upgrade CPUs .....	42



Built-in Ports .....	47
Serial Ports .....	48
PS/2 Mouse Port .....	49
Parallel Port .....	50
Floppy Disk Drive Connector .....	51
IDE Hard Disk Interface .....	53
Installing Expansion Cards .....	56
Installing the System Board .....	58
<b>BIOS Setup Guide .....</b>	<b>60</b>
Award BIOS CMOS Setup Utility .....	61
Standard CMOS Setup .....	61
BIOS Features Setup .....	65
Chipset Features Setup .....	66
Power Management Setup .....	68
PCI Configuration Setup .....	69
Load BIOS Default .....	70
Load Setup Default .....	70
Password Setting .....	70
IDE HDD Auto Detection .....	71
Save and Exit Setup .....	75
Exit Without Saving .....	75
<b>Troubleshooting Checklist .....</b>	<b>76</b>
<b>Appendix A: PCI I/O Pin Assignments .....</b>	<b>77</b>
<b>Appendix B: ISA I/O Pin Assignments .....</b>	<b>78</b>
<b>Appendix C: Connector Pin Assignments .....</b>	<b>79</b>
<b>Appendix D: System Error Report .....</b>	<b>89</b>
<b>Appendix E: Award BIOS Hard Disk Table .....</b>	<b>93</b>



**This page left intentionally blank.**



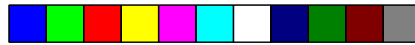

## ❖ Introduction

The G586OPC system board offers several advanced features integrated into the system board. Its design is based on the new Peripheral Component Interconnect (PCI) local bus and Industry Standard Architecture (ISA) standards.

The G586OPC provides a 321-pin Zero Insertion Force (ZIF) CPU socket for Pentium™ processors running at 75MHz, 90MHz, 100MHz, 120MHz, 133MHz or 150MHz frequency. This ZIF socket allows users to easily upgrade their CPUs. It also provides a VRM (Voltage Regulation Module) header allowing you to upgrade to future low-voltage CPUs.

The G586OPC is equipped with three PCI slots, three ISA slots and one shared PCI/ISA slot.

The G586OPC board has two bus master PCI IDE connectors. Bus mastering reduces CPU use during disk transfer. The system board is also equipped with two NS16C550A-compatible serial ports, an SPP/EPP/ECP parallel port, a floppy disk drive controller, one PS/2 mouse port and one PS/2 keyboard connector.

The G586OPC can support 2MB to 128MB of memory using 256Kx36, 512Kx36, 1Mx36, 2Mx36, 4Mx36 and 8Mx36 72-pin SIM modules.



G5860PC

## Product Specifications

### Processor

- Intel Pentium™ processor 75/90/100/120/133/150MHz
- Future Intel Pentium™ processor and Pentium™ OverDrive processor

### Chipset

- OPTi Viper-M chipset

### Cache Memory

- 256KB, 512KB or 1MB direct map write-back or write-through cache
- 32Kx8, 64Kx8 or 128Kx8 asynchronous SRAM (supports 5V/3.3V mixed voltage SRAM)
- 160-pin SRAM upgrade slot for optional synchronous pipeline burst cache module

### System Memory

- Up to 128MB
- Four 72-pin DRAM SIMM sockets
- Supports single and/or double density SIMMs
- 256Kx36, 512Kx36, 1Mx36, 4Mx36 or 8Mx36 parity SIMMs x32 non-parity SIMMs supported
- Supports 60ns or 70ns fast page mode DRAM or EDO DRAM

### BIOS

- Award Plug and Play BIOS
- Supports Enhanced IDE devices
- Supports Enhanced IDE HDDs larger than 528MB (LBA mode only)





## PC/ISA System Board

---

### Energy Efficient Design

- System Power Management supported
- CPU stopped clock control
- Microsoft/Intel APM 1.1 compliant
- Hardware supports SMI green mode

### PCI IDE Interface

- PIO Modes 3 & 4 Enhanced IDE (data transfer rate up to 16.6MB/sec)
- PCI Bus Master IDE (data transfer rate up to 22.2MB/sec)
- Bus mastering reduces CPU use during disk transfer
- ATAPI IDE CD-ROM supported

### Integrated I/O

- SMC FDC37C665GT/FDC37C663GT super I/O controller
- Two NS16C550A-compatible high speed UARTs
- One SPP/EPP/ECP parallel port (FDC37C665GT only)
- One 720KB/1.2MB/1.44MB/2.88MB floppy controller
- PS/2 mouse port
- PS/2 keyboard or AT keyboard connector

### VRM and ZIF Sockets

- VRM (Voltage Regulation Module) header allows optional upgrade to future low-voltage CPUs
- 321-pin ZIF socket (Intel Socket 7)

### Connectors

- 2 serial ports
- 1 parallel port
- 2 IDE connectors
- 1 floppy connector
- 1 mini-DIN-6 PS/2 mouse port



G5860PC

- 1 mini-DIN-6 PS/2 keyboard port or AT keyboard connector

#### **Expansion Slots**

- 3 dedicated PCI slots
- 3 dedicated 16-bit ISA slots
- 1 shared PCI/ISA slot

#### **Architecture**

- PCI/ISA

#### **PCB**

- Four layer, AT form factor
- 28 cm (11.02") x 22 cm (8.58")





PC/ISA System Board

---

## Package Checklist

The G586OPC package contains the following items:

- The G586OPC system board
- The G586OPC user's manual
- One set of IDE driver diskettes
- One 34-pin floppy disk drive cable
- One 40-pin IDE hard disk cables
- One 25-pin printer port cable for chassis mounting
- One card-edge bracket with serial and mouse port cables

If any of these items is missing or damaged, please contact your dealer or sales representative for assistance.





## ❖ Installation Overview

This chapter summarizes the steps in installing the G586OPC system board into your system unit. It also includes a description of the area in which you must work and directions for memory installation. Before installing the system board, obtain the memory you plan to install. Please refer to the memory chart, on pages 8 and 9, for the number and type of SIM modules needed for the amount of memory you require.

### Preparing the Area

Before unpacking the system board, make sure the location you have selected is relatively free of dust and static electricity. Excessive exposure to dust, static electricity, direct sunlight, excessive humidity, extreme cold, and water can damage the operational capabilities of your system board. Avoid placing the unit on surfaces such as carpeted floors. These areas attract static electricity which can damage some circuits on your system board.

Make sure the power source has a properly grounded, three-pronged socket. It is essential that the power connection be properly grounded for correct functioning of your system board. For further protection, we recommend that you use a surge suppressor. This will protect the system board from damage that may result from a power surge on the electrical line.

Move items that generate magnetic fields away from your system board, since magnetic fields can also damage your system board. Once you have selected the



## PC/ISA System Board

---

ideal location, unpack the G586OPC system board carefully.

### Handling the System Board

It is quite easy to inadvertently damage your system board even before installing it to your system unit. Static electrical discharge can damage computer components without causing any signs of physical damage. You must take extra care in handling the system board to ensure against electrostatic build-up.

#### Tips in Handling the System Board

1. To prevent electrostatic build-up, leave the board in its anti-static bag until you are ready to install it.
2. Wear an antistatic wriststrap.
3. Do all preparation work on a static-free surface with components facing up.
4. Hold the system board by its edges only. Be careful not to touch any of the components, contacts or connections, especially gold contacts on the board.
5. Avoid touching the pins or contacts on all modules and connectors. Hold modules and connectors by their ends.

**Warning:**

*Electrostatic discharge (ESD) can damage your upgrade processor, disk drives, add-in boards, and other components. Perform the upgrade instruction procedures described at an ESD workstation only. If such a station is not available, you can provide some*





G586OPC

*ESD protection by wearing an antistatic wrist strap and attaching it to a metal part of the system chassis. If a wrist strap is unavailable, establish and maintain contact with the system chassis throughout any procedures requiring ESD protection.*

## Hardware Installation

### Memory Installation

The G586OPC system board can support 2MB to 128MB of memory using 72-pin SIMMs (Single In-Line Memory Module).

The SIMM sockets are divided into two banks on the system board. The G586OPC system board uses 256Kx36, 512Kx36, 1Mx36, 2Mx36, 4Mx36 and 8Mx36 SIMMs. Non-parity (x32) SIMMs can also be used if parity checking is turned off in CMOS setup. You will need 2 or 4 pieces of SIMMs, depending on the amount of memory you intend to install.

To install the SIM modules, first populate Bank 0 and then Bank 1, or the system will not work.

The table on the next page summarizes the bank locations and modules needed for the corresponding memory sizes. Each bank consists of 2 SIMM sockets.



**PC/ISA System Board**

---

MemorySize	Bank0	Bank1
2MB	256Kx36	-
4MB	256Kx36	256Kx36
4MB	512Kx36	-
8MB	512Kx36	512Kx36
8MB	1Mx36	-
16MB	1Mx36	1Mx36
16MB	2Mx36	-
32MB	2Mx36	2Mx36
32MB	4Mx36	-
48MB	2Mx36	4Mx36
64MB	4Mx36	4Mx36
64MB	8Mx36	-
68MB	512Kx36	8Mx36
72MB	1Mx36	8Mx36
80MB	2Mx36	8Mx36
96MB	4Mx36	8Mx36
128MB	8Mx36	8Mx36

---



G5860PC

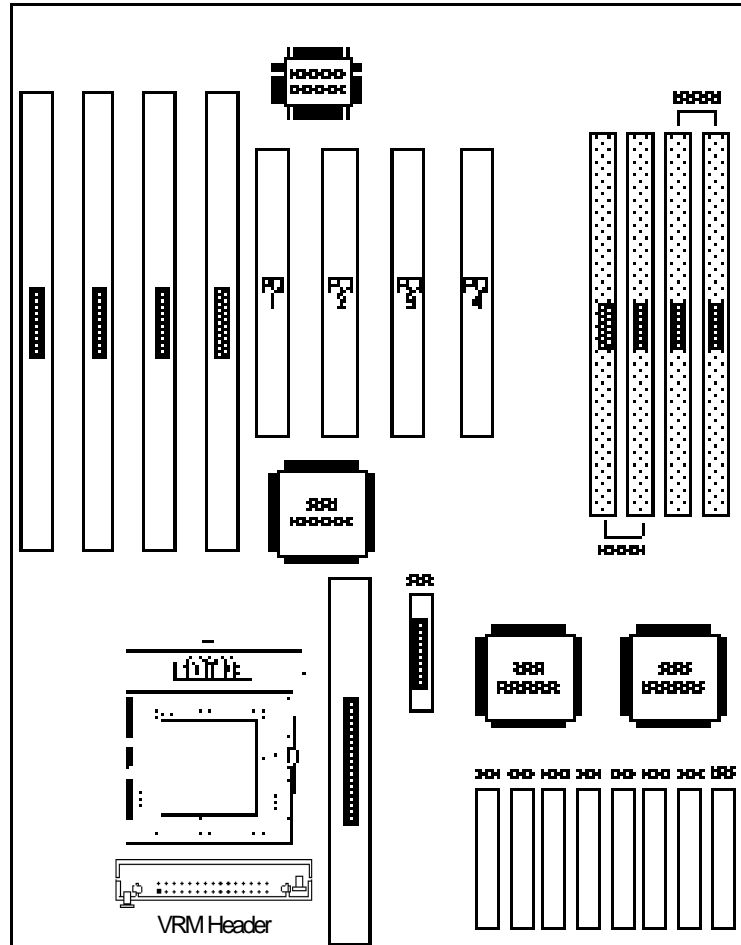

- Pin 1 of the SIMM socket

### Locations of the SIM Sockets on the System Board





## PC/ISA System Board

### Installing the Modules

A SIMM simply snaps into a socket on the system board. Pin 1 of the SIMM must correspond with Pin 1 of the socket.

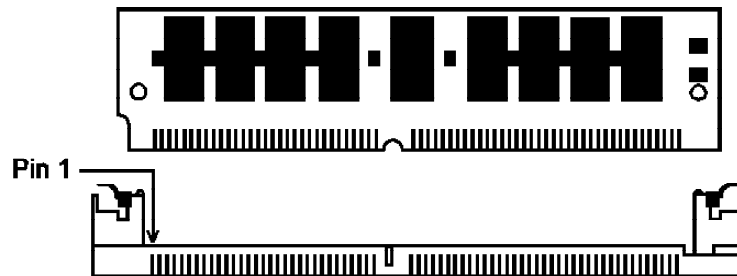

1. Position the SIMM above the socket with the “notch” in the module aligned with the “key” on the socket.
2. Seat the module at a 45° angle into the bank. Make sure it is completely seated. Tilt the module upright until it locks in place in the socket.



## Board Configuration

The G586OPC has jumpers and connectors onboard. Make sure the jumpers are set correctly before installing the system board into your system unit.

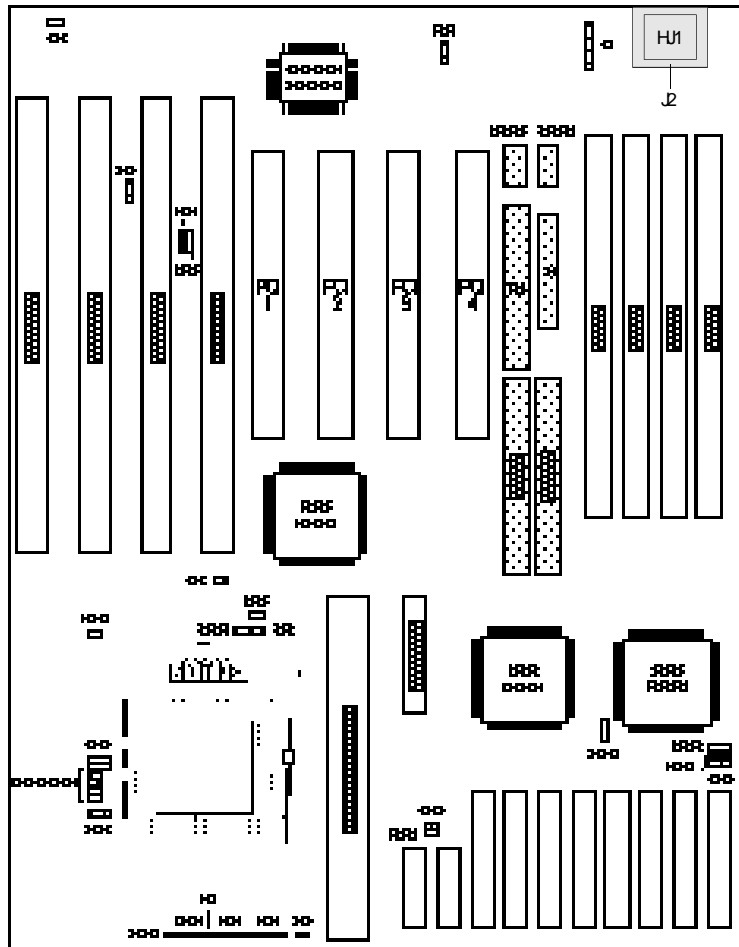



**PC/ISA System Board**

**Jumper Settings**

**Jumper Settings for Display Type and CMOS Clean**

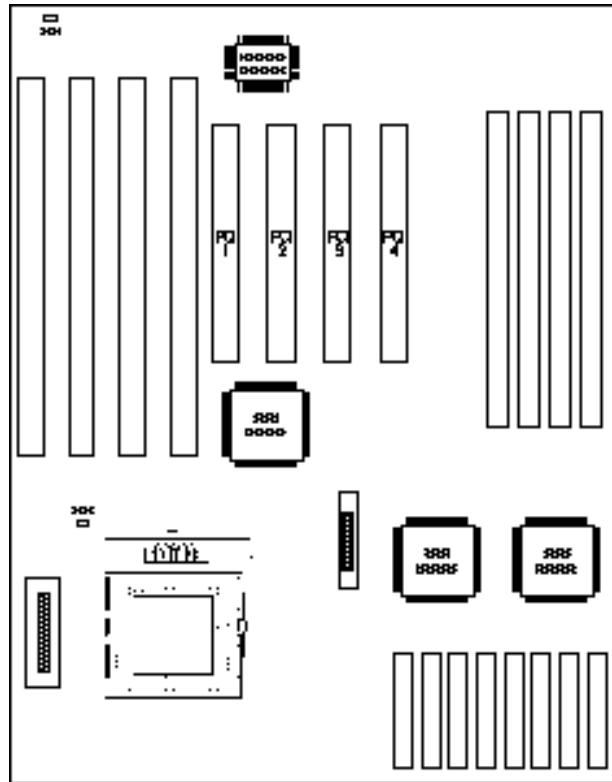

**Locations of Jumpers JP1 and JP11 on the G586OPC System Board**



### Jumper JP1 Display Type Select

Jumper JP1 sets the display adapter to color or mono. This jumper must match the type of display adapter installed. If you change your video adapter, make sure this jumper is changed accordingly.



JP1 Off: Color  
(Default)



JP1 On: Mono

### Jumper JP11 CMOS Clean Select

If, for some reason, the CMOS becomes corrupted, the system can be reconfigured with the default values stored in the ROM BIOS. To load the default values, switch off your computer and remove the cover. Touch the power supply box to discharge any static electric buildup in your body. Set JP11 to On for approximately 5 seconds, then return to the default position (Off). Put the cover back and power up your system.



JP11 Off: Normal  
(Default)



JP11 On: CMOS  
Clean



PC/ISA System Board

**Jumper Settings for Super I/O Setting**

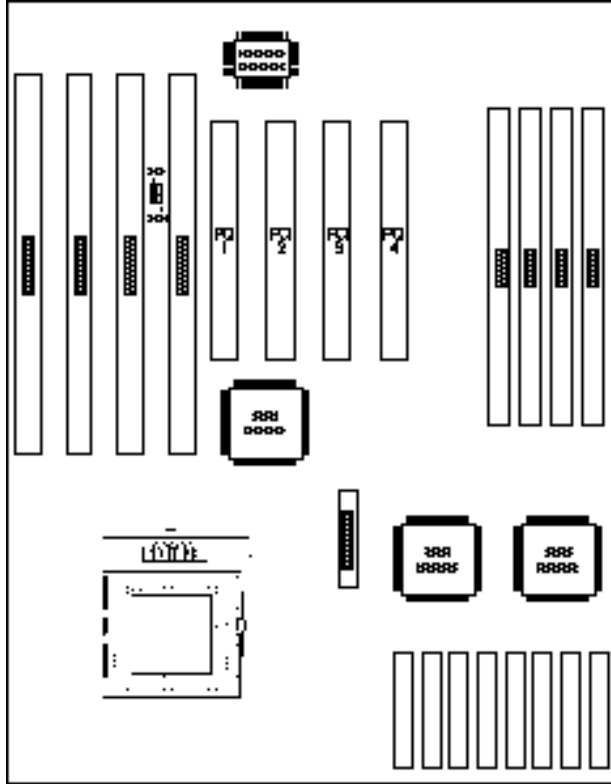

**Locations of Jumpers JP5 and JP6  
on the G5860PC System Board**



### Jumper JP5

ECP DRQ Select (FDC37C665GT only)

The G586OPC system board supports an ECP parallel port that allows you to use DMA Request (DRQ) Channel 1 or 3. Set Jumper JP5 so the ECP port does not conflict with an add-on card's DMA channel.

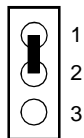

1-2 On: ECP DRQ 3  
(Default)

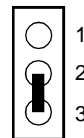

2-3 On: ECP DRQ 1

### Jumper JP6

ECP DACK Select (FDC37C665GT only)

The G586OPC system board supports an ECP parallel port that allows you to use DMA Acknowledge (DACK) Channel 1 or 3. Set Jumper JP6 so the ECP port does not conflict with an add-on card's DMA channel.

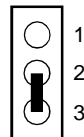

2-3 On: ECP DACK 3  
(Default)

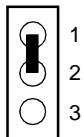

1-2 On: ECP DACK 1



## Cache Configuration

The G586OPC system board can support either asynchronous cache SRAM or synchronous (pipelined burst) cache SRAM. Three cache sizes are supported: 256KB, 512KB and 1MB. 256KB is the default size.

### Installing Asynchronous Cache SRAM

The SRAM sockets allow you to install either 32Kx8, 64Kx8 or 128Kx8 SRAM. Regardless of the amount of cache memory installed, one 32Kx8 (U23) is needed for tag RAM to store the cacheable addresses. The locations of the SRAM sockets on the system board are shown on the next page.

#### Note

*Use only the 5V/3.3V mixed-voltage or pure 3.3V Data SRAM chips if you are changing or upgrading the asynchronous cache RAM of your system board. DO NOT install the regular 5V cache chips in the Data SRAM sockets; otherwise problems will occur because they are not compatible. Regardless of the type of Data SRAM used, install only 5V Tag SRAM on your system board.*

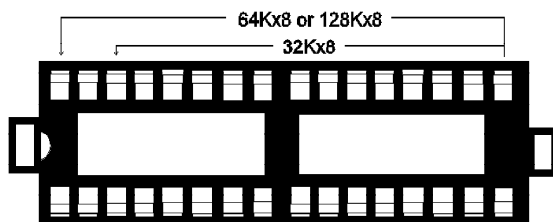

Pin 1

SRAM Socket



G5860PC

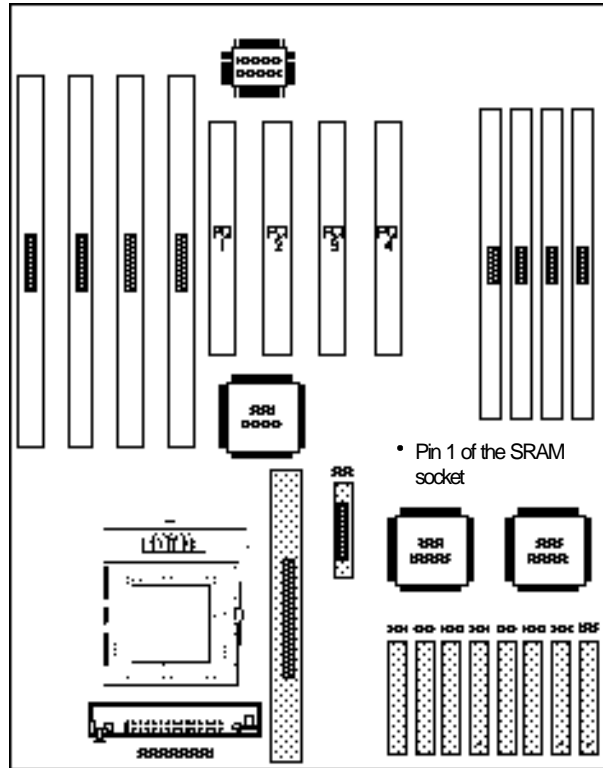





PC/ISA System Board

### Jumper Settings for Cache Memory

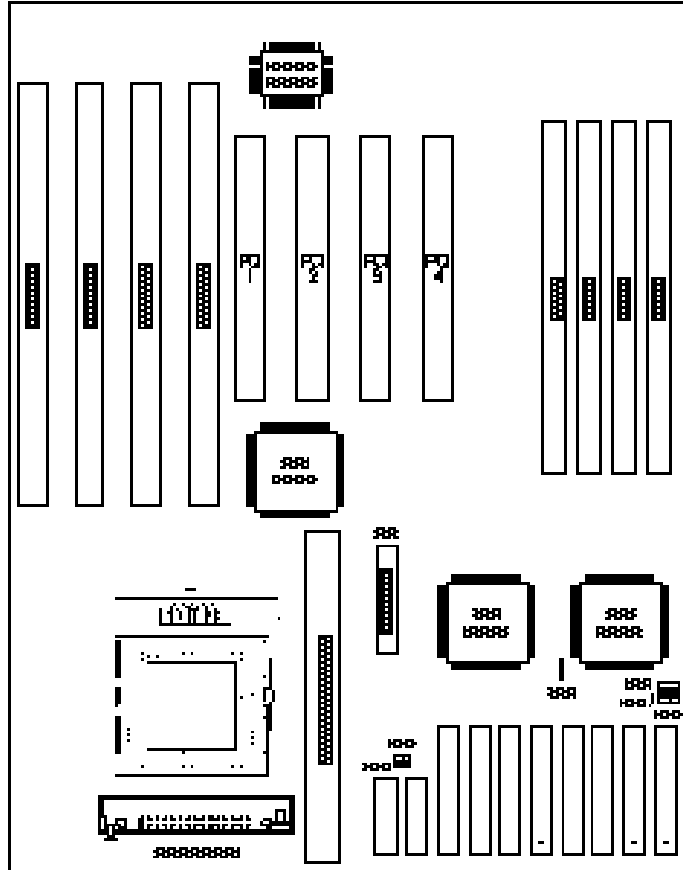

Locations of Jumpers JP12, JP13, JP14, JP15, JP22 and JP23 on the G586OPC System Board

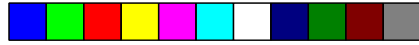

G5860PC

**256KB Cache SRAM \***  
5V/3V Mixed Voltage SRAM



U23  
(5V SRAM)

JP12



JP13

JP14

JP15

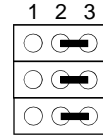

JP22



JP23



U35



U34



U33



U32



U31



U30



U29



U28

\* Default Setting

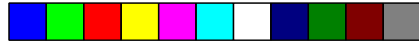

PC/ISA System Board

256KB Cache SRAM  
3.3V SRAM



U23  
(5V SRAM)

JP12

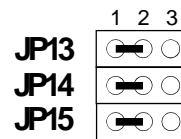

JP22  
JP23

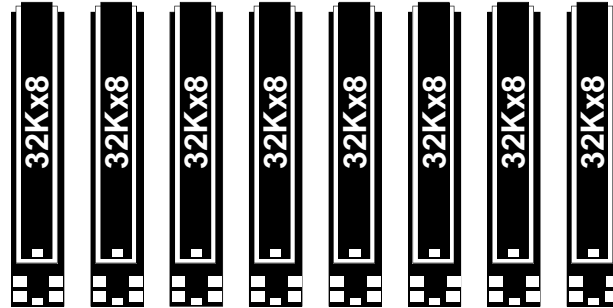

U35 U34 U33 U32 U31 U30 U29 U28





G5860PC

**512KB Cache SRAM**  
5V/3.3V Mixed Voltage SRAM



U23  
(5V SRAM)

JP12

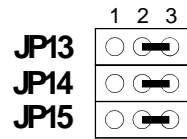

JP22



JP23

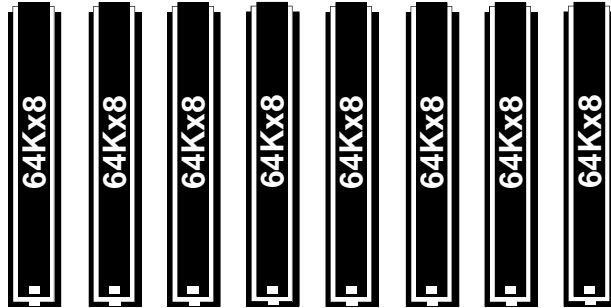

U35 U34 U33 U32 U31 U30 U29 U28



PC/ISA System Board

512KB Cache SRAM  
3.3V SRAM



U23  
(5V SRAM)

JP12

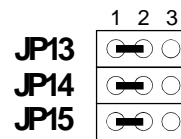

JP22



JP23

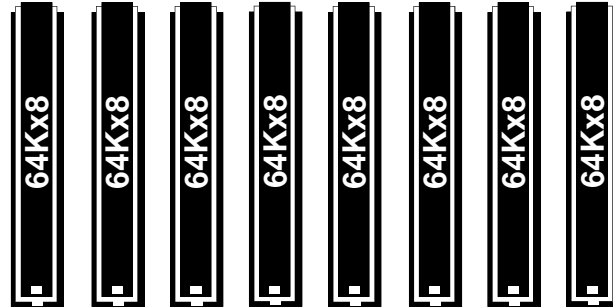

U35 U34 U33 U32 U31 U30 U29 U28



G5860PC

**1MB Cache SRAM**  
5V/3.3V Mixed Voltage SRAM



U23  
(5V SRAM)

JP12

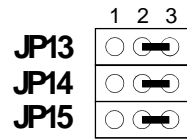
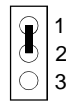

JP22  
JP23

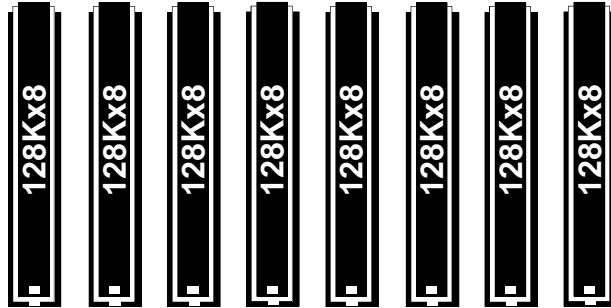

U35 U34 U33 U32 U31 U30 U29 U28

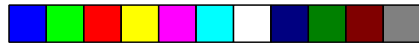

PC/ISA System Board

1MB Cache SRAM  
3.3V SRAM



U23  
(5V SRAM)

JP12

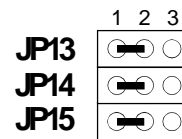
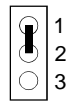

JP22  
JP23

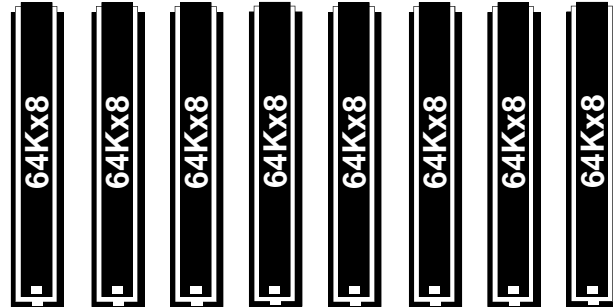

U35 U34 U33 U32 U31 U30 U29 U28





## Installing the Synchronous Cache Module

### Jumper Settings

JP12	JP13	JP14	JP15

**Note:**

*Jumpers JP22 and JP23 are used to select the Level 2 asynchronous cache size. These two jumpers can be ignored when installing the optional synchronous cache module.*



### Cache Module Slot

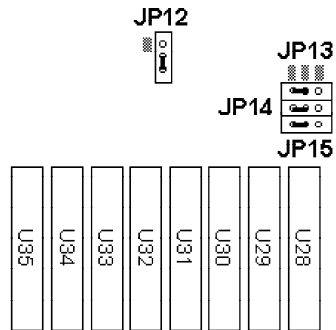
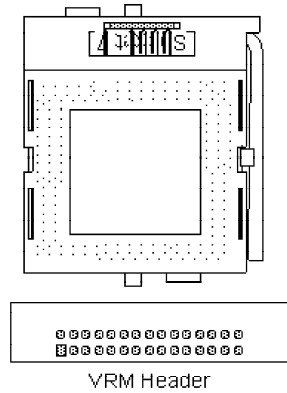





## PC/ISA System Board

### Installation

1. Before installing the optional synchronous pipeline burst cache module, make sure that:
  - the cache chips have been removed from the SRAM sockets U23 (Tag RAM) and U28-U35;
  - Jumpers JP12-JP15 have been set properly (page 26).
2. Locate the 160-pin cache module slot on the system board. Position the cache module above the slot. Make sure pin 1 of the cache module is aligned with pin 1 of the slot. Carefully slide the module into the slot. Press firmly on the top of it to seat it properly.

#### Note:

*With the optional synchronous pipeline burst cache module installed in the cache module slot, the length of the add-in card in PCI Slot 2 is limited to 124,65 mm.*

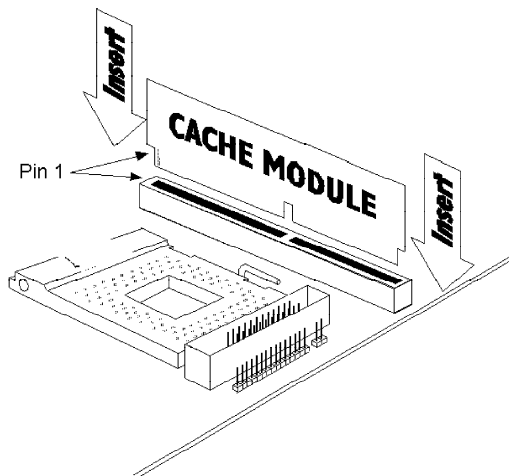



G5860PC

3. Once the synchronous cache module has been installed, you should make the following modifications in the “Chipset Features Setup” menu of the Award BIOS CMOS Setup Utility.

1. **SRAM Type:** Sync
2. **SYNC SRAM Support:** Pipeline
3. **Cache Read Burst:** 3-1-1-1
4. **Cache Write Burst:** 3-1-1-1 or 4-1-1-1



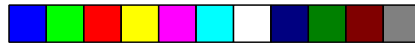

## PC/ISA System Board

---

### VRM Header

Your G586OPC system board is equipped with a VRM (Voltage Regulation Module) header shown below. It allows you to upgrade to future low-voltage CPUs by installing a Voltage Regulation Module.

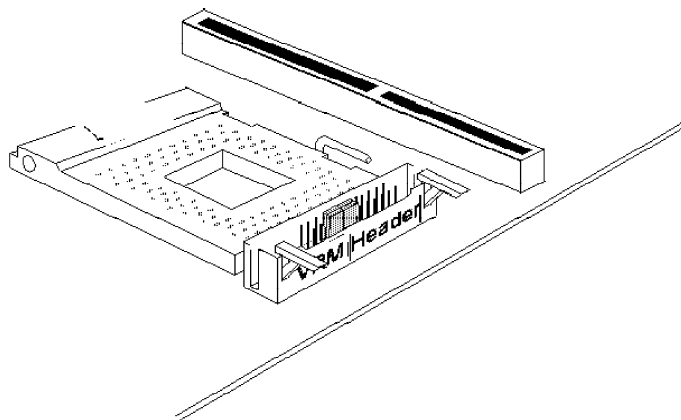

**VRM Header on the System Board**

### VRM Header and 3.3V Pentium Processor

When using a 3.3V Pentium processor, pins 4-5, 6-7, 19-20 and 21-22 of the VRM header must be set to On. These settings are presented on the next page.



G586OPC

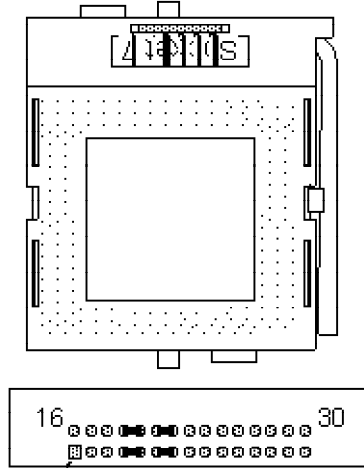

Pin 1

**Pins 4-5, 6-7, 19-20 and 21-22 are set to On**

### **VRM Header and Future Low-Voltage CPUs**

The types of VRM supported and installation procedures will be described in a future edition of the G586OPC manual.



## PC/ISA System Board

### CPU Installation

The G586OPC is equipped with a 321-pin Zero Insertion Force (ZIF) socket at location U26 of the system board. The ZIF socket allows for easy installation of upgrade CPUs as your system needs grow. Make sure all jumpers are set correctly before applying power, or you may damage the CPU or system board.

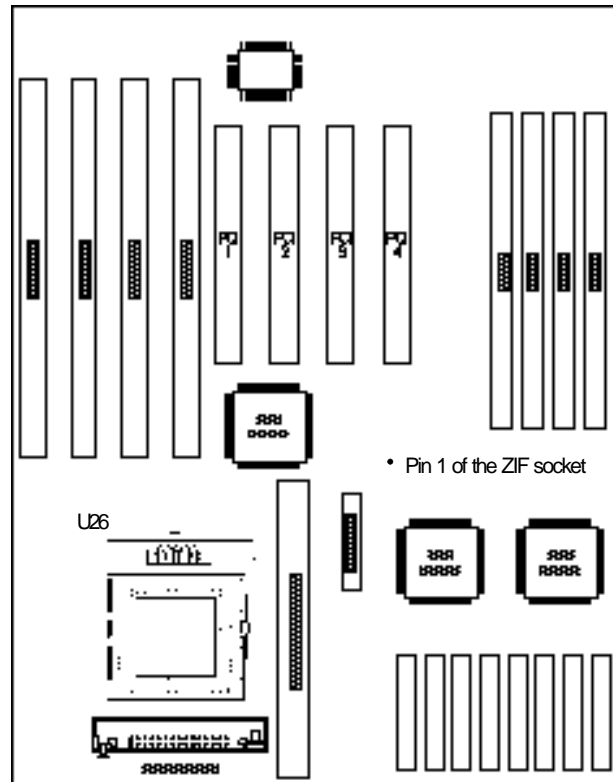

Location of the ZIF Socket on the System Board



G5860PC

### Jumper Settings for CPU

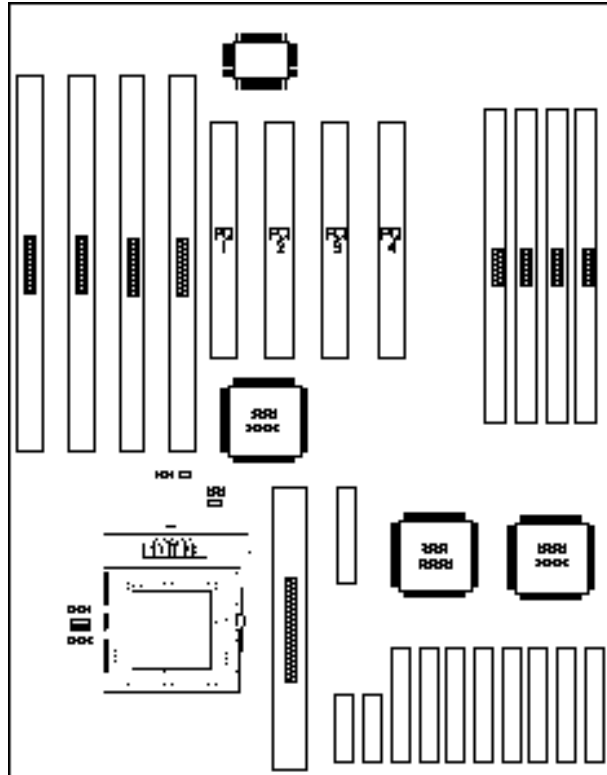

Locations of Jumpers JP7, JP8, JP16 and JP17  
on the G5860PC System Board



PC/ISA System Board

**3.3V Pentium Processor (75MHz)**  
System (External) Bus Speed: 50MHz

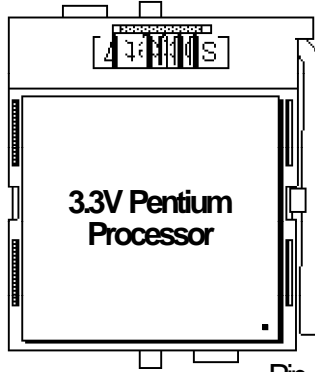
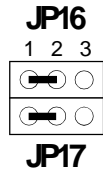

Pin 1

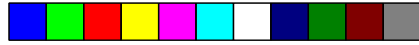

G5860PC

**3.3V Pentium Processor (90MHz) \***  
System (External) Bus Speed: 60MHz

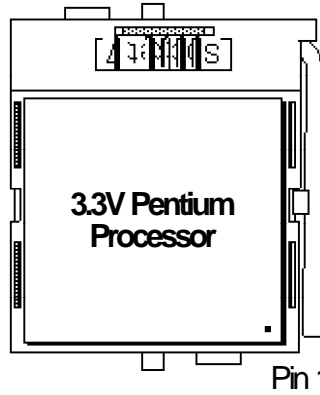
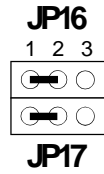
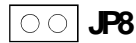

\* Default Setting



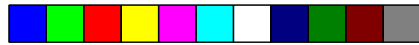

PC/ISA System Board

**3.3V Pentium Processor (100MHz)**  
System (External) Bus Speed: 50MHz

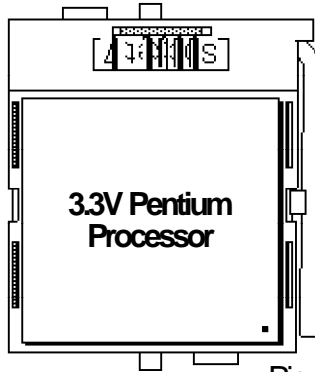
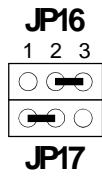
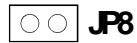

Pin 1



G5860PC

**3.3V Pentium Processor (100MHz)**  
System (External) Bus Speed: 66MHz

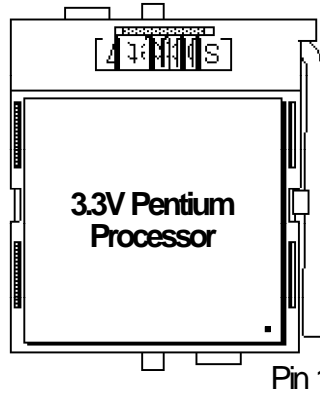
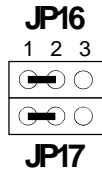

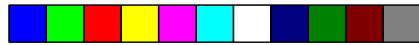

PC/ISA System Board

3.3V Pentium Processor (120MHz)  
System (External) Bus Speed: 60MHz

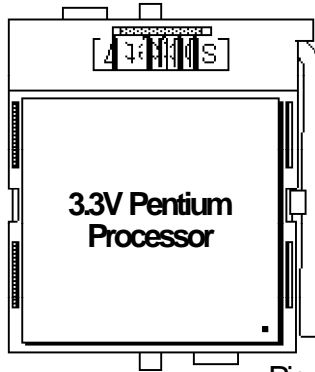
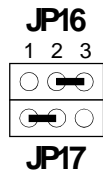
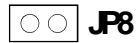

Pin 1



G5860PC

**3.3V Pentium Processor (133MHz)**  
System (External) Bus Speed: 66MHz

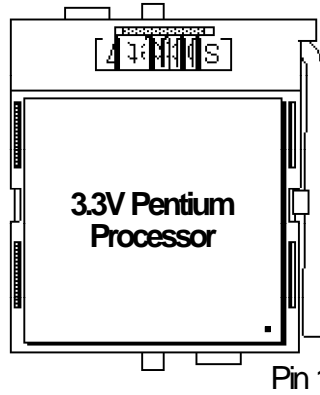
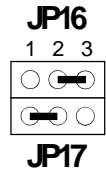



PC/ISA System Board

**3.3V Pentium Processor (150MHz)**  
System (External) Bus Speed: 50MHz

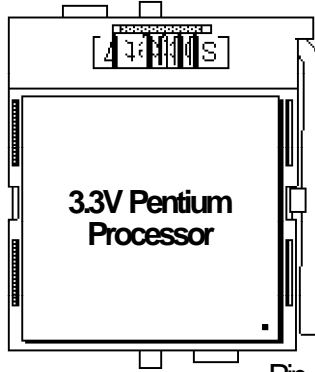
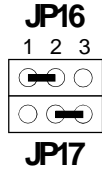

Pin 1



G5860PC

**3.3V Pentium Processor (150MHz)**  
System (External) Bus Speed: 60MHz

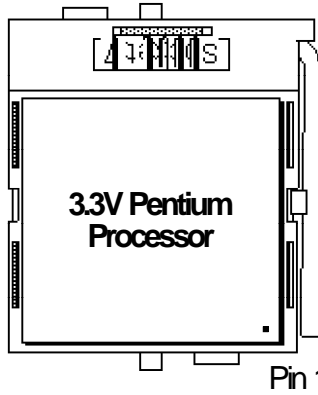
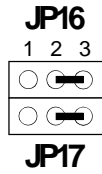

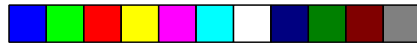

## PC/ISA System Board

### Jumpers JP3, JP4, JP9, JP10, JP18, JP19, JP20, JP21 and JP24

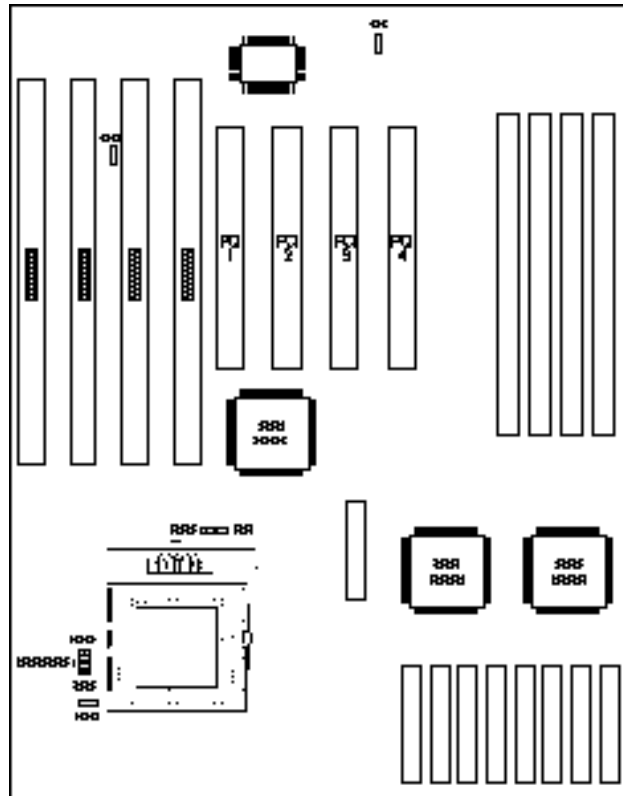

The following jumpers are for factory testing only and should always be set to their default configurations. Reconfiguring these jumpers will cause problems with your system board.

**JP3:** Off  
**JP4, JP24:** 1-2 On  
**JP9, JP10, JP18, JP19, JP20, JP21:** On



## Installing Upgrade CPUs

The G5860PC is equipped with a 321-pin Zero Insertion Force (ZIF) socket at location U26 of the system board. This socket is designed for easy removal of the old CPU and easy insertion of the upgrade CPU. The socket allows you to carefully place the new CPU into its position. If you need to apply excessive force to insert the CPU, the installation is being done incorrectly.

### **Warning:**

*Open the socket only if actually installing a CPU. The warranty on the original CPU will be voided if the S/N seal is broken.*

*Do not change any factory CPU speed jumper settings. You do not need to change any jumpers to properly install the 3.3V Pentium Upgrade Processor.*

*Before proceeding with the upgrade, take note of the following. The microprocessor and heat sink may be hot if the system has been running. To avoid the possibility of a burn, power the system off and let the processor and heat sink cool for 10 minutes.*

The 321-pin ZIF socket consists of the four rows of pin holes on each side. To prevent improper OverDrive Processor installation, the ZIF socket has a Plug/Keying mechanism. Several holes in the socket are plugged so OverDrive Processors will go in only one way. If you cannot easily insert the OverDrive Processor, verify that pin 1 of the CPU is aligned with pin 1 of the socket. A warning note — be extremely careful to match pin 1 of the CPU with pin 1 of the socket. Only Intel's OverDrive Processor is keyed to prevent improper placement in the ZIF socket. Other Intel CPUs, as well





## PC/ISA System Board

as CPUs from other vendors, can be placed incorrectly and will be permanently damaged.

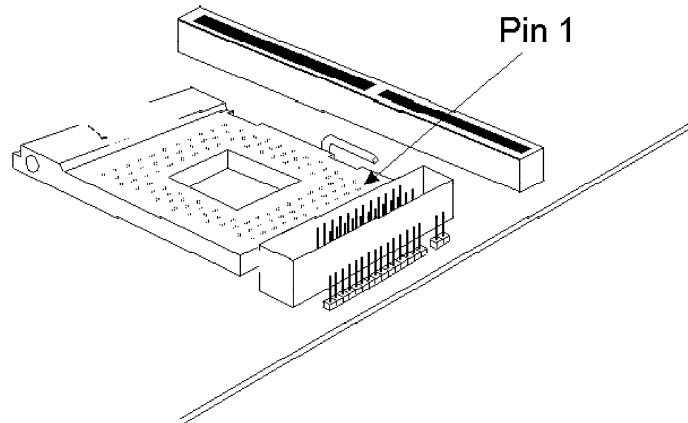

### Zero Insertion Force (ZIF) Socket

To install an upgrade CPU, do the following.

1. Make sure the handle on the side of the ZIF socket is up. To raise the handle, push down, pull it out to the side a little and raise it as far as it will go. The top plate will slide back. Do not use screwdrivers or other tools to open the socket, or damage may occur to the system or socket. It may be necessary to initially apply a small amount of sideways force to free the handle from its retaining "tab." Once clear of the "tab," the handle will open relatively easily.



G5860PC

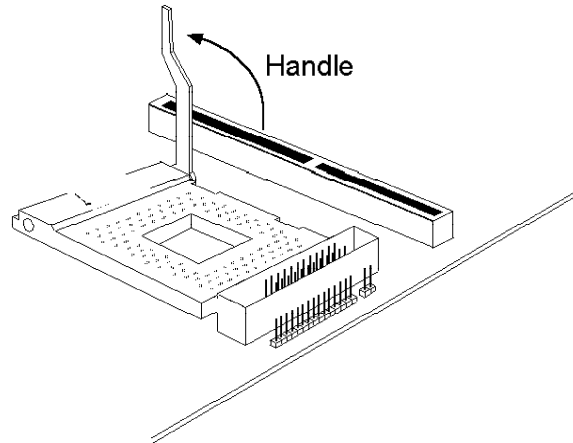

### Lifting the Handle

2. Once the lever is completely up, remove the old CPU by carefully lifting it straight out of the socket. You are now ready to insert the new CPU.

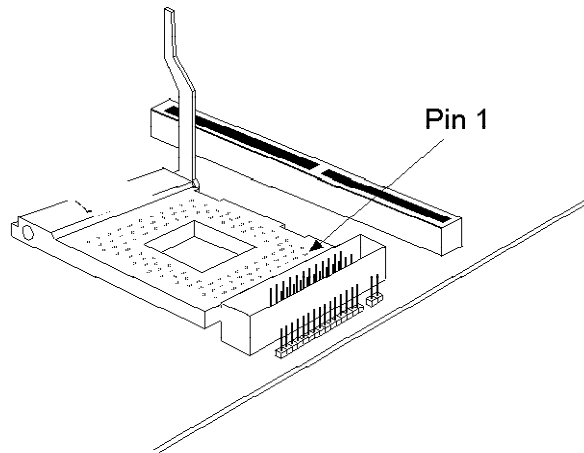

### Pin 1 of the ZIF Socket



## PC/ISA System Board

3. Position the CPU above the ZIF socket. Make sure pin 1 of the CPU is aligned with pin 1 of the socket. Lower the chip until the pins are inserted properly in their corresponding holes. Remember that very little force is needed to install the CPU. If the CPU will not insert easily, verify pin 1 of the CPU is aligned with pin 1 of the socket. Applying too much pressure can damage the CPU or the socket.

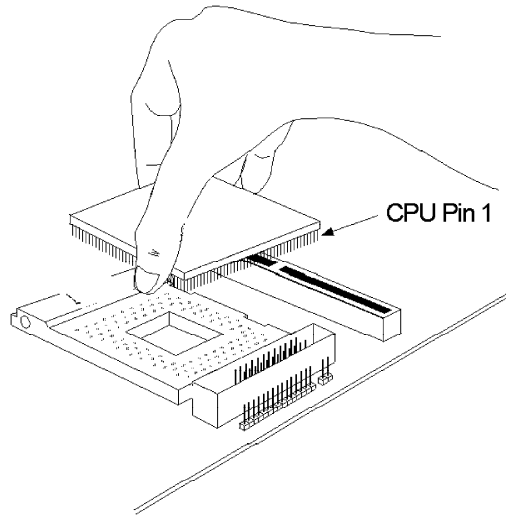

### Positioning the CPU Above the ZIF Socket

4. Push the handle down until the handle locks into place. The top plate will slide forward. You will feel some resistance as the pressure starts to secure the CPU in the socket. This is normal and will not damage the CPU. However, if the handle is not completely closed, damage to the CPU and/or system board may result.

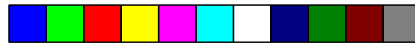

### Clearance Requirements

The 3.3V Pentium Upgrade Processor comes with a heat sink mounted on top. To maintain proper airflow once the upgrade is installed on the system board, the processor and sink require certain space clearances.

The clearance above 3.3V Pentium Upgrade Processor's fan/heat-sink must be at least 0.4 in. The clearance on at least 3 of 4 sides of the processor must be at least 0.2 in. The cables (for floppy drive, hard drive, CD-ROM, etc.) must be routed clear of the CPU and its airspace.

### Fan Exhaust

The CPU must be kept cool by using a fan exhaust configuration in connection with the heatsink. The temperature of the air entering the fan/heatsink cannot exceed 45°C. The ambient or room temperature must be below 37°C (99°F) for a system installed with the 3.3V Pentium Upgrade Processor.

In order to provide proper airflow to the CPU, all movable obstructions (power supply cables, cards, floppy disk cables) must be clear of the CPU heatsink/fan component in accordance with the space clearance discussed in the CPU installation section of this manual.



## PC/ISA System Board

### Built-in Ports

The G586OPC system board is equipped with two serial ports, one SPP/EPP/ECP parallel printer port, one FDD connector, one PS/2 mouse port and two IDE hard disk shrouded headers.

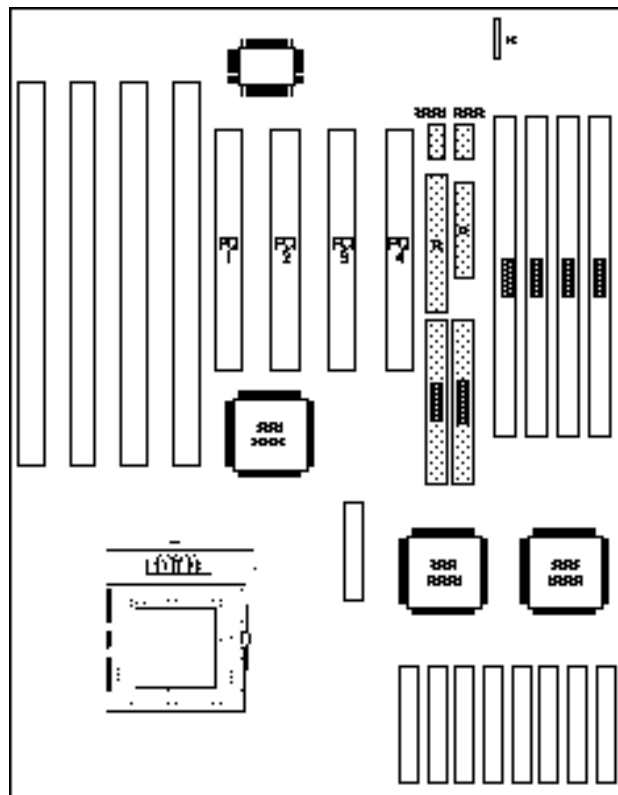

Locations of the Built-in Ports on the System Board



## Serial Ports

The built-in serial ports are RS-232C asynchronous communication ports with 16C550A-compatible UARTs that can be used with modems, serial printers, remote display terminals, and other serial devices. They use the following system I/O addresses:

Port Configuration	I/O Address
COM1	3F8h
COM2	2F8h
COM3/COM4	3E8h/2E8h

## Connecting the Serial Ports

Two DB-9P serial port cables are provided with the motherboard. They are mounted on a card-edge bracket along with the PS/2 mouse cable. The upper serial port cable should be used for the COM 1 primary serial port; connect it to Connector COM 1 on the motherboard. The lower serial port cable should be used for the COM 2 secondary serial port; connect it to Connector COM 2 on the motherboard. Make sure the colored stripes on the ribbon cables align with pin 1 of Connectors COM 1 and COM 2. Mount the card-edge bracket to the system chassis.

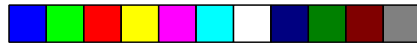

## PC/ISA System Board

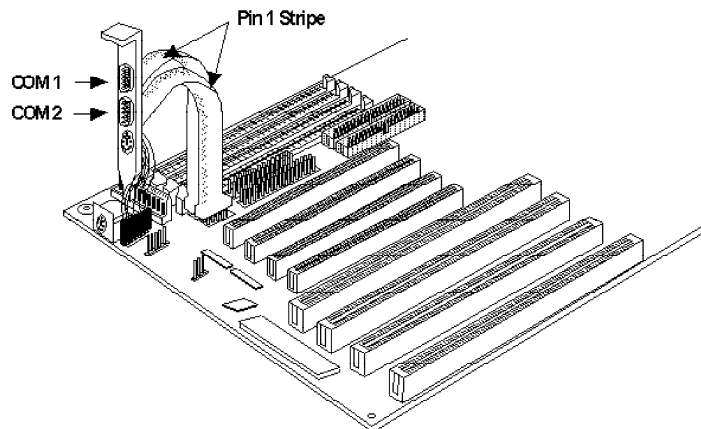

### The Primary and Secondary Serial Ports on the G586OPC System Board

#### PS/2 Mouse Port

The PS/2 mouse port is a 6-pin connector on the system board. Attach the 6-pin mouse port cable, which came in the G586OPC box, to Connector J1. Make sure the brown wire on the PS/2 mouse connector aligns with pin 1 of connector J1.



G5860PC

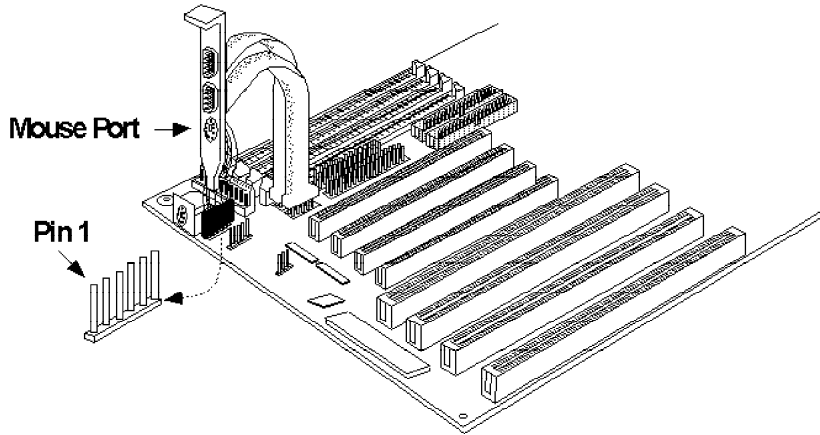

### The PS/2 Mouse Port on the G5860PC System Board

#### Parallel Port

The G5860PC system board has a standard connector for interfacing your PC to a parallel printer. This port is compatible with both IBM AT printer ports and the new, high speed, bidirectional Extended Capabilities Port standard. The parallel port on your system board can be set to any of the following system I/O addresses:

**I/O Address:** 3BC-3BE Hex  
378-37A Hex \*  
278-27A Hex

\* Default setting





## PC/ISA System Board

### Connecting the Parallel Printer Port

Attach the DB-25S printer port cable, which came with the motherboard, to Connector J7 on the G586OPC system board. Make sure the colored stripe on the ribbon cable aligns with pin 1 of Connector J7. Use a small nutdriver to mount the cable into a DB-25 cutout in the system chassis.

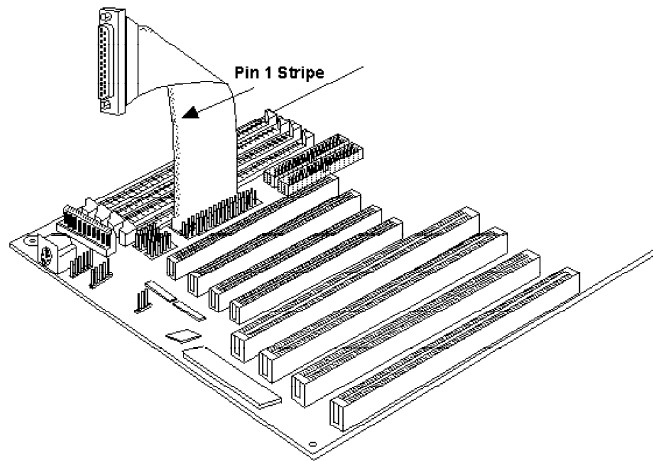

### The Parallel Printer Port on the G586OPC System Board

### Floppy Disk Drive Controller

The G586OPC system board has a built-in floppy disk controller that supports two standard floppy disk drives. You can install any 720KB/1.2MB/1.44MB/2.88MB floppy disk drives.



G5860PC

## Connecting the Floppy Disk Cable

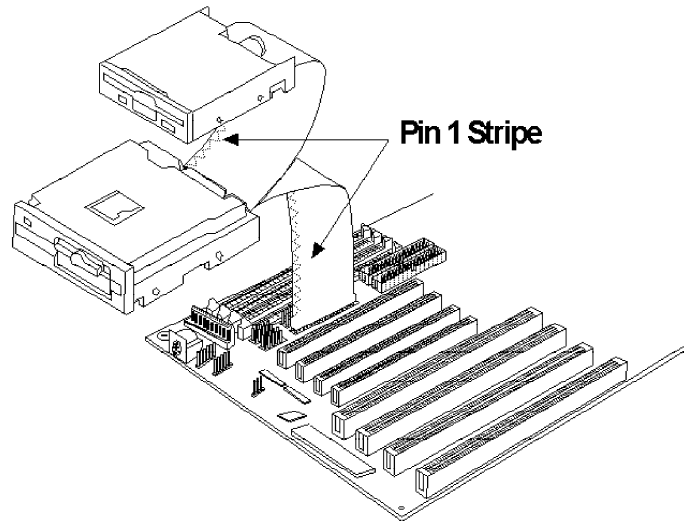

### The Floppy Disk Connector on the G5860PC System Board

#### Step 1

Install the 34-pin header connector into the floppy disk connector (J8) on the system board. The colored edge of the ribbon should be aligned to pin 1 of the J8 connector.

#### Step 2

Install the other 34-pin header connector(s) into the disk drive(s) with the colored edge of the daisy chained ribbon cable aligned to pin 1 of the drive edge connector(s). The end-most connector should be attached to the drive you want to be Drive A.



## PC/ISA System Board

### IDE Hard Disk Interface

The G586OPC system board is equipped with two PCI IDE shrouded headers that will interface four IDE (Integrated Drive Electronics) hard disk drives.

**Note:**  
*Only IDE drives can be connected to the IDE interface.*

#### Connecting the IDE Hard Disk Interface

To prevent improper IDE cable installation, each PCI IDE shrouded header has a keying mechanism. The 40-pin connector on the IDE cable can be placed into the header only if pin 1 of the connector is aligned with pin 1 of the header.

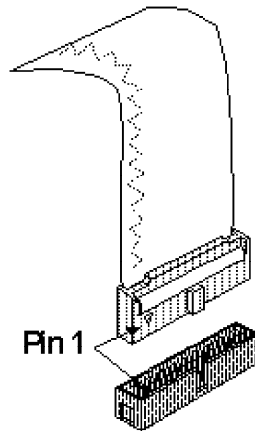

**Note:**  
*The IDE cable with a standard 40-pin connector can be installed in the PCI IDE shrouded header. Be extremely careful to match the colored edge of the ribbon with pin 1 of the header.*



G5860PC

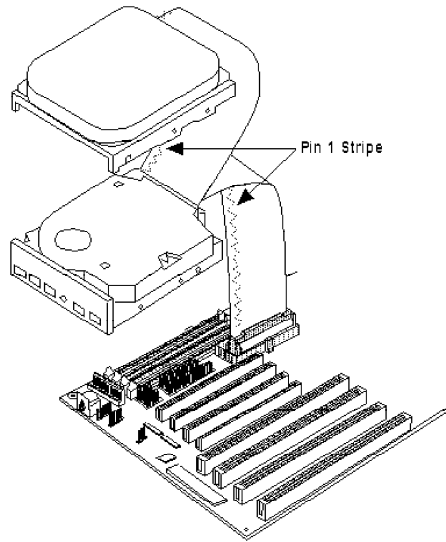

### The IDE Hard Disk Connector on the System Board

#### Step 1

If you are connecting two hard drives, install the 40-pin connector of the IDE cable into the primary IDE shrouded header (1st IDE Connector). If you are adding a third or fourth IDE device, install the 40-pin connector of the other IDE cable into the secondary IDE shrouded header (2nd IDE Connector).

#### Step 2

Install the other 40-pin header connector(s) into the device with the colored edge of the ribbon cable aligned to pin 1 of the drive edge connector(s).

#### Note:

*Refer to your disk drive user's manual for information about selecting proper drive switch settings.*



## PC/ISA System Board

---

### Adding a Second IDE Hard Drive

When using two IDE drives, one must be set as the master and the other as the slave. Follow the instructions provided by the drive manufacturer for setting the jumpers and/or switches on the drives. No changes are needed on the G586OPC system board when adding a second hard drive.

We recommend that the IDE hard drives be from the same manufacturer. In a few cases, drives from two manufacturers will not function properly when used together. The problem lies in the hard drives, not the G586OPC system board.

### Preparing an IDE Drive for Use

IDE disk drives are already low-level formatted, with any bad-track errors entered, when shipped by the drive manufacturer. Do not attempt to do a low-level format, or you may cause serious damage to the drive.

To use an IDE drive, you need to enter the drive type (this information is provided by the drive manufacturer) into the system's CMOS setup table. Then run FDISK and FORMAT provided with DOS.

**Note:**

*Do not run FDISK and FORMAT programs on a drive that has already been formatted, or you will lose all programs and data stored on the drive.*



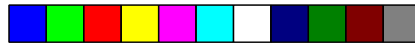

## Installing Expansion Cards

The G5860PC is equipped with three dedicated PCI and three dedicated ISA slots. One PCI slot and one ISA slot are shared. You can only install a card in one or the other of the shared slots at a time; you cannot install devices in both slots. Due to the size of the optional synchronous pipeline burst cache module installed in the 160-pin cache module upgrade slot, the length of the card in PCI Slot 2 is limited. Refer to page 27 for limitations. The locations of the expansion slots are shown on the next page.

**Note:**

*The BIOS needs to be configured for the PCI add-on cards installed in the PCI slots. Refer to the “PCI Configuration Setup” chapter presented in the “Initial Setup Program” section of the manual.*

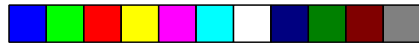

PC/ISA System Board

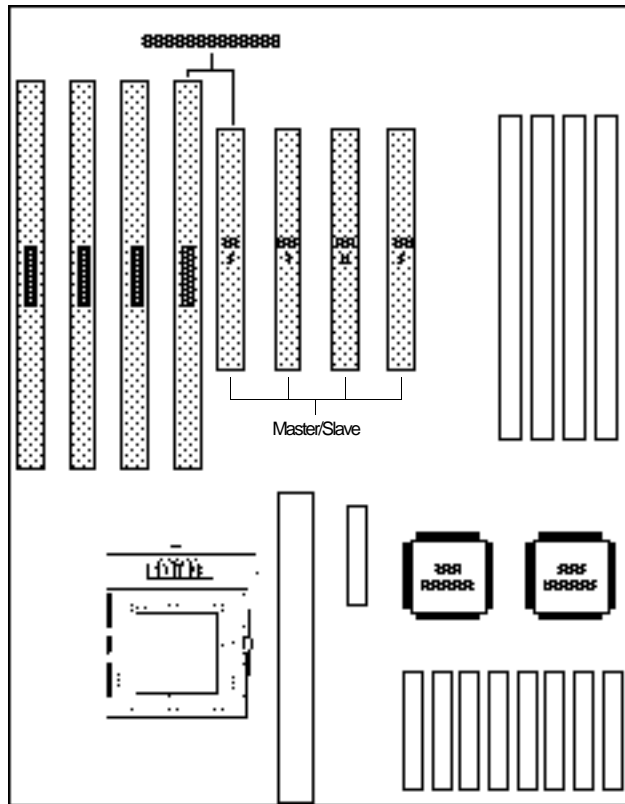

Expansion Slots on the G5860PC System Board

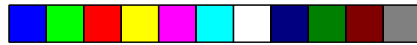

G5860PC

## Installing the System Board

Before installing the system board into your system unit, you should prepare the tools you will need:

You will need:

- *one medium size, flat-bladed screwdriver*
- *one medium Phillips screwdriver*

### Step 1

Unlock your system unit. Turn off the power and disconnect all power cords and cables.

### Step 2

Remove the system unit cover. Refer to the manufacturer's instructions if necessary.

### Step 3

Remove expansion cards seated in any of the expansion slots and detach all connectors from the old system board.

### Step 4

Loosen the screws holding the original system board and remove the board from the system. Save the screws.





## PC/ISA System Board

---

### Step 5

Remove the G586OPC from its original packing box. Be careful to avoid touching all connectors and pins on the board. Please refer to the handling instructions on pages 6-8 for proper handling techniques.

### Step 6

Insert the SIMMs into the SIMM banks on the G586OPC. The quantity and location of the SIMMs is dependent upon the memory configuration and type of modules you intend to use.

### Step 7

Install the CPU. Be sure pin 1 of the CPU is aligned with pin 1 of the socket.

### Step 8

Set the corresponding jumpers.

### Step 9

Install the prepared G586OPC system board into the case and replace the screws.

### Step 10

Reinstall all cards and connectors and replace the system unit cover. Reconnect all power cords and cables.



## ❖ BIOS Setup Guide

After you power up your system, the BIOS message appears on your screen and the memory count begins.

After the memory test, the following message will appear on the screen:

**Press DEL to enter setup**

If the message disappears before you respond, restart your system or press the “Reset” button. You may also restart the system by pressing the <Ctrl> <Alt> <Del> keys. If you do not press these keys at the correct time and the system does not boot, the following error message will appear:

**Press Del to enter Setup**

If you have set a password and selected “System” in the Security Option of the BIOS Feature Setup menu, you will be prompted for the password everytime the system is rebooted or any time you try to enter Setup. Type in the correct password and press <Enter>.

If you selected “Setup” in the Security Option, you will be prompted for the password only when you try to enter Setup. Refer to the “BIOS Features Setup” section for more information.



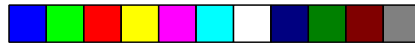

PC/ISA System Board

## Award BIOS CMOS Setup Utility

Press <Ctrl> <Alt> <Esc> or <Del> simultaneously to enter the Setup utility. A screen similar to the one below will appear.

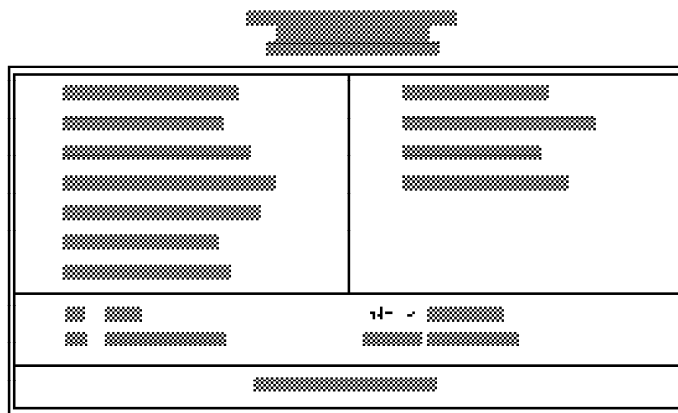

Use the arrow keys to highlight the option you want and press <Enter>.

## Standard CMOS Setup

Use the arrow keys to highlight “Standard CMOS Setup” and press <Enter>, a screen similar to the one on the next page will appear.



G5860PC

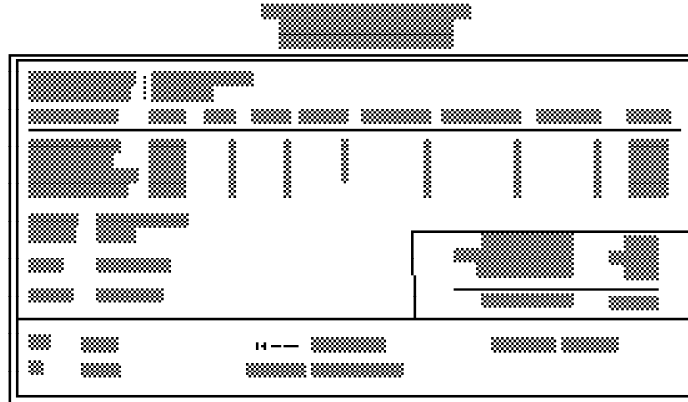

### Date and Time

Sets the time and date for the system. Press <F3> for the calendar. These items cannot be altered; they are detected and displayed automatically.

### Hard Drive Type

This allows you to enter the appropriate specifications for the type of hard disk drive(s) installed in your system. Under the “Type” category, you can select Auto, User, one of 46 predefined drive specifications or None.

#### Auto

This option indicates that the parameters for your hard disk drive(s) will be automatically detected and displayed when you boot your system.

By default, the LBA mode is selected for a hard disk drive larger than 528 Megabytes. If you decide not to accept the LBA mode, you can either specify your selection in the “IDE HDD Auto Detection” menu, or use the User option described below.



## PC/ISA System Board

---

### User

This type is user definable and allows you to enter the specifications yourself directly from the keyboard. Six categories of information are required: Size, Cylinders, Heads, Precomp, LandZone and Sectors. This information should be provided by your hard disk vendor or system manufacturer. However, we recommend you use the "IDE HDD Auto Detection" which provides a more efficient way to setup your hard drive.

### 46 Predefined Drive Specifications

The tables on pages 93 and 94 give complete listings of the available drive types. Any given hard drive must be set to one specific drive type number. Please refer to your hard disk documentation for the appropriate type number.

### None

Select <None> and press <Enter> if a hard drive is not installed.

### Drive A and Drive B

These options are used to select the type of floppy disk drives installed in your system. If neither drive is present, select "None". Make sure you choose the correct drive type; otherwise, your system might format the device improperly.



G5860PC

## Video

This is used to select the type of video adapter installed in your system.

## Halt on

This category controls whether the system will halt in case an error is detected during power up.

**No Errors:** The system boot will not stop for any detected errors.

**All Errors:** The system will stop whenever the BIOS detects a non-fatal error.

**All, But Keyboard:** The system will stop for any error except a keyboard error.

**All, But Diskette:** The system will stop for any error except a disk error.

**All, But Disk/Key:** The system will stop for any error except a keyboard or disk error.

## Memory

The lower right hand corner shows the base memory size, extended memory size, and the other memory size of your system. You cannot alter these items; your computer automatically detects and displays them.

The Other Memory size refers to the memory located in the 640K to 1024K address space. This is the memory used for different applications. DOS uses this area to load device drivers to free base memory for application programs.

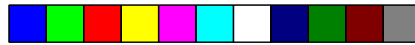

## PC/ISA System Board

When you are through making changes in the Standard CMOS Setup, press <Esc> to return to the main menu.

### BIOS Features Setup

Use the arrow keys to highlight “BIOS Features Setup” and press <Enter>, a screen similar to the one below will appear.

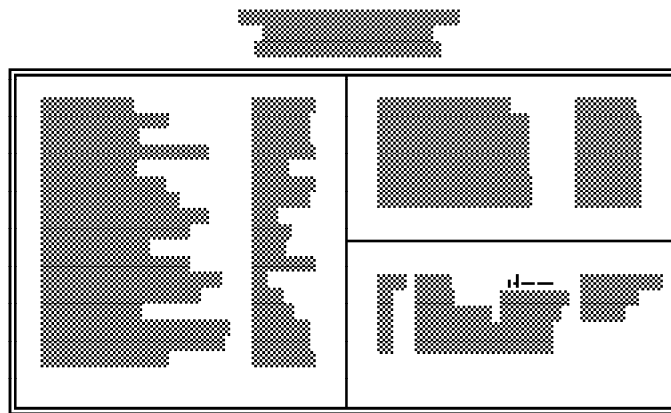

The Virus Warning option may be set to “Enabled” or “Disabled”. When enabled, the BIOS issues a warning when any program or virus sends a Disk Format command or attempts to write to the boot sector of the hard disk drive.



If you choose “System” in the Security Option, you will be prompted for a password every time you cold boot your system or access setup. If you choose “Setup”, you will be prompted for a password only when trying to access setup.

Use the arrow keys to move the highlight bar to the option you wish to change or modify. Use the <Page Up>, <Page Down>, <+> or <-> keys to make the corresponding changes. Press <Esc> after making the changes to return to the main menu.

### Chipset Features Setup

The G586OPC uses the OPTi Viper-M chipset. The Chipset Features Setup allows you to modify some functions to optimize system performance. It also allows you to enable, disable or select the port address of the built-in serial ports, parallel port, floppy disk controller and hard disk controller.

If you press <Enter>, a screen similar to the one on the next page will appear. Use the arrow keys to move the highlight bar to the option you wish to change or modify. Use the <Page Up>, <Page Down>, <+> or <-> keys to make the corresponding changes.

If the changes you made are incorrect or you change your mind, press <F6> or <F7> to return to the default settings. Press <Esc> after making the changes to return to the main menu.





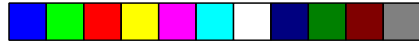

PC/ISA System Board

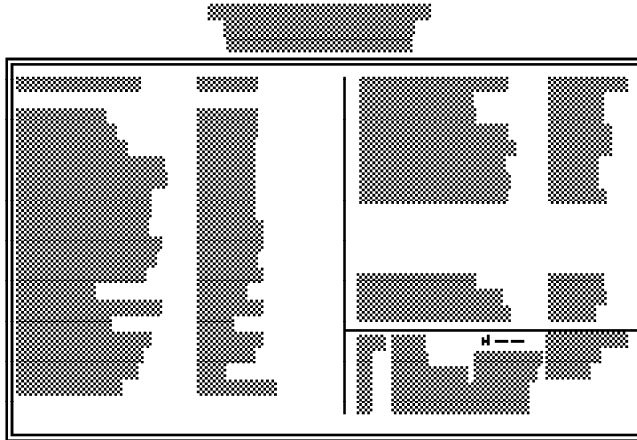

SMC FD37C665GT Integrated I/O Chip

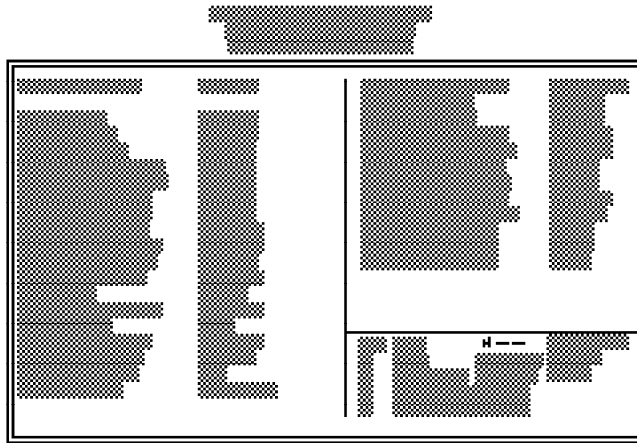

SMC FD37C663GT Integrated I/O Chip





## Power Management Setup

Use the arrow keys to highlight “Power Management Setup” and press <Enter>. A screen similar to the one below will appear.



Choosing “Enabled” in the Power Management option will allow you to set Doze Mode, Standby Mode and Suspend Mode. Choose “Disabled” if you do not want your system to enter the power saving mode.



PC/ISA System Board

### PCI Configuration Setup

Use the arrow keys to highlight “PCI Configuration Setup” and press <Enter>; a screen similar to the one below will appear.



The G586OPC system board supports four PCI slots. Each slot may be assigned INT A, B, C, D if the card installed in the slot requires an interrupt. Each INT may then be assigned an IRQ value. This is done automatically if the “PnP BIOS Auto-Config” option is enabled.



## Load BIOS Defaults

The “Load BIOS Defaults” option loads the troubleshooting default values permanently stored in the ROM chips. These settings are non-optimal and turn off all high performance features. You should use these values only if you have hardware problems. Highlight this option in the main screen and press <Enter>. The message below will appear.

### Load BIOS Defaults (Y/N)? N

If you want to proceed, press <Y> and the default settings will be loaded.

## Load Setup Defaults

The “Load Setup Defaults” option loads optimized settings from the BIOS ROM. Use the Setup default values as standard values for your system.

Highlight this option on the main menu and press <Enter>. The message below will appear.

### Load Setup Defaults (Y/N)? N

Type <Y> and press <Enter> to load the Setup default values.

## Password Setting

If you want to set a password, make sure that the Security Option under the BIOS Features Setup is set to “System” or “Setup”. Refer to the BIOS Features Setup option for more information.



## PC/ISA System Board

---

Use the arrow keys to highlight the Password Setting option and press <Enter>. The message below will appear.

### **Enter Password:**

Type in the password. You are limited to eight characters. Type in a password that is eight characters long or shorter. When done, the message below will appear:

### **Confirm Password:**

You are asked to verify the password. Type in exactly the same password. If you type in a wrong password, you will be prompted to enter the correct password again. Otherwise, enter a new password.

To delete or disable the password function, simply press <Enter> instead of typing in a new password. Press the <Esc> key to return to the main menu.

## **IDE HDD Auto Detection**

This option detects the hard disk parameters for the hard disk drives installed in your system. Highlight this option and press <Enter>. A screen similar to the one on the next page will appear.





G586OPC

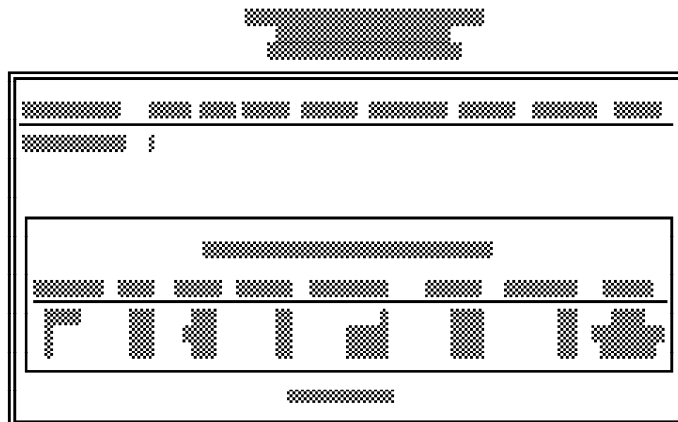

Enter your choice, “Y”, “1” or “3”, and press <Enter> to accept the parameters or press <Esc> to abort. The parameters of the hard disk will be displayed in the Standard CMOS Setup.

### Hard Drive Mode

The G586OPC supports three HDD modes: Normal, LBA and Large. If your hard disk drive does not support LBA mode, the “LBA” option will not be displayed. If your HDD has 1024 or fewer cylinders, the “Large” option will not be displayed.

#### Normal Mode

The Normal mode is the generic access mode in which neither the BIOS nor the IDE controller will make any transformations during hard-drive access.

The maximum number of cylinders, heads and sectors for Normal mode are 1024, 16 and 63, respectively.



## PC/ISA System Board

---

no. Cylinders	(1024)
x no. Heads	( 16)
x no. Sectors	( 63)
x bytes per sector	( 512)

---

528 Megabyte

If you set your HDD to Normal mode, the maximum accessible HDD size will be 528 Megabytes even though its physical size may be greater than that.

### **LBA (Logical Block Addressing) Mode**

The LBA mode is a new HDD accessing method to overcome the 528 Megabyte limitation. The number of cylinders, heads and sectors shown on the screen may not be the actual number for the HDD.

During the HDD accessing, the IDE controller will transform the logical address described by the sector, head and cylinder number into its own physical address inside the HDD.

The maximum HDD size supported by the LBA mode is 8.4 Gigabytes. It is obtained by the following formula.

no. Cylinders	(1024)
x no. Heads	( 225)
x no. Sectors	( 63)
x bytes per sector	( 512)

---

8.4 Gigabyte



### Large Mode

The Large mode is the extended HDD access mode supported by the G586OPC system board. Some IDE HDDs have more than 1024 cylinders without LBA support (in some cases, you may not want the LBA mode). The system board provides another alternative to support these kinds of HDD.

The BIOS tells the operating system that the number of cylinders is 1/2 of actual and that the number of heads is double the actual. During the disk access, the reverse conversion is done by the INT13h routine.

Example of Large mode:

CYLS.	HEADS	SECTORS	MODE
1120	16	59	NORMAL
560	32	59	LARGE

Maximum HDD size:

	no. Cylinders	(1024)
x	no. Heads	( 32)
x	no. Sectors	( 63)
x	bytes per sector	( 512)
		<hr/>
		1 Gigabyte

**Note:**

*To support LBA or Large mode, address translation software is included in the Award BIOS HDD Service Routine (INT13h). If you are running an operating system that bypasses the BIOS Int13 Service Routine, LBA and Large Mode may fail.*





## PC/ISA System Board

---

### Save & Exit Setup

When all the changes have been made, highlight “Save & Exit Setup” and press <Enter>. The message below will appear:

**Save to CMOS and Exit (Y/N)? N**

Type “Y” and press <Enter>. The following message will appear:

**Reboot System (Y/N)? N**

Type “Y” and press <Enter>. The modifications you have made will be written into the CMOS memory, and the system will reboot. You will once again see the initial diagnostics on the screen. If you wish to make additional changes to the setup, press <Ctrl> <Alt> <Esc> or <Del> simultaneously after memory testing is done.

### Exit Without Saving

When you do not want to save the changes you have made, highlight this option and press <Enter>. The message below will appear:

**Quit Without Saving (Y/N)? N**

Type “Y” and press <Enter>. The system will reboot and you will once again see the initial diagnostics on the screen. If you wish to make any changes to the setup, press <Ctrl> <Alt> <Esc> or <Del> simultaneously after memory testing is done.



## ❖ Troubleshooting Checklist

If you experience difficulty with the G586OPC system board, please refer to the checklist below. If you still cannot isolate the problem, please contact your dealer.

- 1) Check the jumper settings to ensure that the jumpers are properly set. If in doubt, refer to the “Board Configuration” section.
- 2) Verify that all SIM modules are seated securely into the bank sockets.
- 3) Make sure the SIM modules are in the correct locations.
- 4) Check that all populated memory banks are filled with valid size SIM modules.
- 5) If your board fails to function, place the board on a flat surface and seat all socketed components (gently press each component into the socket).
- 6) If you made changes to the BIOS settings, re-enter setup and load the BIOS defaults.



## ❖ Appendix A: PCI I/O Pin Assignments

Component Side	B	A	Solder Side
	-12V	- 01 -	TRST#
	TCK	- 02 -	+12V
	Ground	- 03 -	TMS
	TDO	- 04 -	TDI
	+5V	- 05 -	+5V
	+5V	- 06 -	INTA#
	INTB#	- 07 -	INTC#
	INTD#	- 08 -	+5V
	PRSNT1#	- 09 -	Reserved
	Reserved	- 10 -	+5V (I/O)
	PRSNT2#	- 11 -	Reserved
	Ground	- 12 -	Ground
	Ground	- 13 -	Ground
	Reserved	- 14 -	Reserved
	Ground	- 15 -	RST#
	CLK	- 16 -	+5V (I/O)
	Ground	- 17 -	GNT#
	REQ#	- 18 -	Ground
	+5V (I/O)	- 19 -	Reserved
	AD[31]	- 20 -	AD[30]
	AD[29]	- 21 -	+3.3V
	Ground	- 22 -	AD[28]
	AD[27]	- 23 -	AD[26]
	AD[25]	- 24 -	Ground
	+3.3V	- 25 -	AD[24]
	C/BE[3]#	- 26 -	IDSEL
	AD[23]	- 27 -	+3.3V
	Ground	- 28 -	AD[22]
	AD[21]	- 29 -	AD[20]
	AD[19]	- 30 -	Ground
	+3.3V	- 31 -	AD[18]
	AD[17]	- 32 -	AD[16]
	C/BE[2]#	- 33 -	+3.3V
	Ground	- 34 -	FRAME#
	IRDY#	- 35 -	Ground
	+3.3V	- 36 -	TRDY#
	DEVSEL#	- 37 -	Ground
	Ground	- 38 -	STOP#
	LOCK#	- 39 -	+3.3V
	PERR#	- 40 -	SDONE
	+3.3V	- 41 -	SBO#
	SERR#	- 42 -	Ground
	+3.3V	- 43 -	PAR
	C/BE[1]#	- 44 -	AD[15]
	AD[14]	- 45 -	+3.3V
	Ground	- 46 -	AD[13]
	AD[12]	- 47 -	AD[11]
	AD[10]	- 48 -	Ground
	Ground	- 49 -	AD[09]
	AD[08]	- 52 -	C/BE[0]#
	AD[07]	- 53 -	+3.3V
	+3.3V	- 54 -	AD[06]
	AD[05]	- 55 -	AD[04]
	AD[03]	- 56 -	Ground
	Ground	- 57 -	AD[02]
	AD[01]	- 58 -	AD[00]
	+5V (I/O)	- 59 -	+5V (I/O)
	ACK64#	- 60 -	REQ64#
	+5V	- 61 -	+5V
	+5V	- 62 -	+5V



## ❖ Appendix B: ISA I/O Pin Assignments

B		A
Grnd	- 01 -	-I/OChck
ResetDrv	- 02 -	SD7
+5VDC	- 03 -	SD6
IRQ9	- 04 -	SD5
-5VDC	- 05 -	SD4
DRQ2	- 06 -	SD3
-12VDC	- 07 -	SD2
O/S	- 08 -	SD1
+12VDC	- 09 -	SD0
Grnd	- 10 -	-I/OChrdy
-SEMEMW	- 11 -	AEN
-SEMEMR	- 12 -	SA19
-IOW	- 13 -	SA18
-IOR	- 14 -	SA17
-Dack3	- 15 -	SA16
-DRQ3	- 16 -	SA15
-Dack1	- 17 -	SA14
DRQ1	- 18 -	SA13
-Refresh	- 19 -	SA12
CLK	- 20 -	SA11
IRQ7	- 21 -	SA10
IRQ6	- 22 -	SA9
IRQ5	- 23 -	SA8
IRQ4	- 24 -	SA7
IRQ3	- 25 -	SA6
-Dack2	- 26 -	SA5
T/C	- 27 -	SA4
Bale	- 28 -	SA3
+5VDC	- 29 -	SA2
O/S	- 30 -	SA1
Grnd	- 31 -	SA0

D		C
-MemCS16	- 01 -	SBHE
-I/OCS16	- 02 -	LA23
IRQ10	- 03 -	LA22
IRQ11	- 04 -	LA21
IRQ12	- 05 -	LA20
IRQ13	- 06 -	LA19
IRQ14	- 07 -	LA18
-Dack0	- 08 -	LA17
DRQ0	- 09 -	-Memr
-Dack5	- 10 -	-Memw
DRQ5	- 11 -	SD08
-Dack6	- 12 -	SD09
DRQ6	- 13 -	SD10
-Dack7	- 14 -	SD11
DRQ7	- 15 -	SD12
+5VDC	- 16 -	SD13
-Master	- 17 -	SD14
Grnd	- 18 -	SD15





G5860PC

**Connector J1**  
PS/2 Mouse Connector

Pin	Function
1	Mouse Data
2	Reserved
3	Ground
4	+5V
5	Mouse Clock
6	Reserved

**Connector J7**  
Parallel Printer Port

Pin	Function
1	-Strobe
2	Data 0
3	Data 1
4	Data 2
5	Data 3
6	Data 4
7	Data 5
8	Data 6
9	Data 7
10	-Ack
11	Busy
12	Paper Empty
13	Select
14	-Autofd
15	-Error
16	-Init
17	-Slctin



## PC/ISA System Board

---

Pin	Function
18	Ground
19	Ground
20	Ground
21	Ground
22	Ground
23	Ground
24	Ground
25	Ground

---

## Connector J8 Floppy Disk Drive Connector

Pin	Function
1	Ground
2	DENSEL
3	Ground
4	Reserved
5	Ground
6	Drate0
7	Ground
8	Index
9	Ground
10	MTR0
11	Ground
12	DR1
13	Ground
14	DR0
15	Ground
16	MTR1
17	Drate1

---

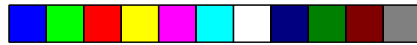

G5860PC

Pin	Function
18	Dir
19	Ground
20	Step
21	Ground
22	Write Data
23	Ground
24	Write Gate
25	Ground
26	Track 0
27	MSEN
28	Wr Protect
29	Ground
30	Read Data
31	Ground
32	Head Select
33	Ground
34	Disk Change

**1st IDE**  
Primary IDE Hard Disk Drive Connector

Pin	Function
1	-Reset
2	Ground
3	D7
4	D8
5	D6
6	D9
7	D5
8	D10
9	D4



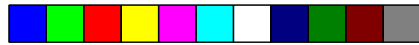

PC/ISA System Board

---

Pin	Function
10	D11
11	D8
12	D12
13	D2
14	D13
15	D1
16	D14
17	D0
18	D15
19	Ground
20	Reserved
21	DRQ0
22	Ground
23	+10V
24	Ground
25	+10R
26	Ground
27	IOCHRDY
28	BALE
29	DACK0
30	Ground
31	IRQ14
32	IOCS16
33	SA1
34	Reserved
35	SA0
36	SA2
37	HCS0
38	HCS1
39	LED
40	Ground

---



G5860PC

**2nd IDE**  
Secondary IDE Hard Disk Drive Connector

Pin	Function
1	-Reset
2	Ground
3	D7
4	D8
5	D6
6	D9
7	D5
8	D10
9	D4
10	D11
11	D3
12	D12
13	D2
14	D13
15	D1
16	D14
17	D0
18	D15
19	Ground
20	Reserved
21	DRQ1
22	Ground
23	-IOW
24	Ground
25	-IOR
26	Ground
27	Reserved
28	BALE
29	DACK1
30	Ground



### PC/ISA System Board

---

Pin	Function
31	IRQ15
32	IOCS16
33	SA1
34	Reserved
35	SA0
36	SA2
37	HCS0
38	HCS1
39	LED
40	Ground

---

### COM1 and COM2

Primary (COM1) and Secondary (COM2) Serial Ports

Pin	Function
1	DCD (Data Carrier Detect)
2	RX (Receive Data)
3	TX (Transmit Data)
4	DTR (Data Terminal Ready)
5	Ground (Signal Ground)
6	DSR (Data Set Ready)
7	RTS (Request to Send)
8	CTS (Clear to Send)
9	RI (Ring Indicator)

---



G5860PC

**Connector J15**  
HD LED Connector

Pin	Function
1	IDE LED
2	VCC

**Connector J17**  
Speaker Connector

Pin	Function
1	Data
2	NC
3	Ground
4	VCC

**Connector J18**  
Keylock Connector

Pin	Function
1	LED Signal
2	Reserved
3	Ground
4	Keylock Signal
5	Ground



## PCI/ISA System Board

### Connector JP25

Green LED/Turbo LED Connector

Pin	Function
1	LED (-)
2	LED (+)

**Note:**

*Connector JP25 functions as Green LED Connector if the Power Management option is enabled (“Power Management Setup”).*

### Connector JP26

Turbo Switch Connector

Pin	Function
1	Turbo
2	GND

### Connector S1

Hardware Reset Connector

Pin	Function
1	GND
2	Reset



G586OPC

**Connector HJ1**  
PS/2 Keyboard Connector

Pin	Function
1	Keyboard Data
2	NC
3	Ground
4	VCC
5	Keyboard CLK
6	NC

**Connector J2**  
AT Keyboard Connector

Pin	Function
1	Keyboard CLK
2	Keyboard Data
3	NC
4	Ground
5	VCC

**Note:**  
*Your G586OPC system board is equipped only with one of these connectors: Connector HJ1 or Connector J2.*



## ❖ Appendix D: System Error Report

When the BIOS encounters an error that requires the user to correct something, either a beep code will sound or a message will be displayed in a box in the middle of the screen and a message PRESS F1 TO CONTINUE, CTRL-ALT-ESC or DEL TO ENTER SETUP will be shown in the information box at the bottom.

### POST Beep

There is one beep code in BIOS. This code indicates that a video error has occurred and the BIOS cannot initialize the video screen to display any additional information. This beep code consists of a single long beep followed by two short beeps.

### Error Messages

One or more of the following messages may be displayed if the BIOS detects an error during the POST.

#### **DISK BOOT FAILURE, INSERT SYSTEM DISK AND PRESS ENTER**

No boot device was found. Insert a system disk into Drive A and press <Enter>. If the system normally boots from the hard drive, make sure the controller is inserted correctly and all cables are properly attached. Also be sure the disk is formatted as a boot device. Then reboot the system.

#### **DISKETTE DRIVES OR TYPES MISMATCH ERROR - RUN SETUP**

Type of diskette drive installed in the system is different from the CMOS definition. Run setup to reconfigure the drive type correctly

**DISPLAY SWITCH IS SET INCORRECTLY**

The display switch on the motherboard can be set to either monochrome or color. This indicates the switch is set to a different setting than indicated in Setup. Determine which setting is correct, and then either turn off the system and change the jumper, or enter Setup and change the VIDEO selection.

**DISPLAY TYPE HAS CHANGED SINCE LAST BOOT**

Since last powering off the system, the display adapter has been changed. You must configure the system for the new display type.

**ERROR ENCOUNTERED INITIALIZING HARD DRIVE**

Hard drive cannot be initialized. Be sure the adapter is installed correctly and all cables are correctly and firmly attached. Also, be sure the correct hard drive type is selected in Setup (refer to page 22).

**ERROR INITIALIZING HARD DISK CONTROLLER**

Cannot initialize controller. Make sure the card is correctly and firmly installed in the bus. Be sure the correct hard drive type is selected in Setup. Also, check to see if any jumper needs to be set correctly on the hard drive.

**FLOPPY DISK CNTRLR ERROR OR NO CNTRLR PRESENT**

Cannot find or initialize the floppy drive controller. Make sure the controller is installed correctly and firmly. If no floppy drive is installed, be sure the Diskette Drive selection in Setup is set to NONE.





## PC/ISA System Board

---

### **KEYBOARD ERROR OR NO KEYBOARD PRESENT**

Cannot initialize the keyboard. Make sure the keyboard is attached correctly and no keys are being pressed during the boot.

If you are purposely configuring the system without a keyboard, set the error halt condition in Setup to HALT ON ALL, BUT KEYBOARD. This will cause the BIOS to ignore the missing keyboard and continue the boot.

### **MEMORY ADDRESS ERROR AT...**

Indicates a memory address error at a specific location. You can use this location along with the memory map for your system to find and replace the bad memory chips.

### **MEMORY PARITY ERROR AT...**

Indicates a memory parity error at a specific location. You can use this location along with the memory map for your system to find and replace the bad memory chips.

### **MEMORY SIZE HAS CHANGED SINCE LAST BOOT**

Memory has been added or removed since the last boot. Enter Setup and enter the new memory size in the memory fields.

### **MEMORY VERIFY ERROR AT...**

Indicates an error verifying a value already written to memory. Use the location along with your system's memory map to locate the bad chip.

### **OFFENDING ADDRESS NOT FOUND**

This message is used in conjunction with the I/O CHANNEL CHECK and RAM PARITY ERROR messages when the segment that has caused the problem cannot be isolated.



**OFFENDING SEGMENT**

This message is used in conjunction with the I/O CHANNEL CHECK and RAM PARITY ERROR messages when the segment that has caused the problem has been isolated.

**PRESS A KEY TO REBOOT**

This will be displayed at the bottom screen when an error occurs that requires a reboot. Press any key and the system will reboot.

**PRESS F1 TO DISABLE NMI, F2 TO REBOOT**

When BIOS detects a Non-Maskable Interrupt condition during boot, this will allow NMI to be disabled and continue to boot. You can also reboot the system with the NMI enabled.

**RAM PARITY ERROR - CHECKING FOR SEGMENT**

Indicates a parity error in Random Access Memory.

**SYSTEM HALTED, (CTRL-ALT-DEL) TO REBOOT..**

Indicates the present boot attempt has been aborted and the system must be rebooted. Press and hold down the CTRL and ALT keys and press DEL simultaneously.



## ❖ Appendix E: Award BIOS Hard Disk Table

Type	Size (MB)	Cylinders	Heads	Sectors	Write Precomp	Land Zone	Example Model
1	10	306	4	17	128	305	TEAC SD510, MMI 112, 5412
2	20	615	4	17	300	615	Seagate ST225, ST4026
3	30	615	6	17	300	615	
4	62	940	8	17	512	940	
5	46	940	6	17	512	940	
6	20	615	4	17	None	615	Seagate ST125, Tandon TM262
7	30	462	8	17	256	511	
8	30	733	5	17	None	733	Tandon TM 703
9	112	900	15	17	None	901	
10	20	820	3	17	None	820	
11	35	855	5	17	None	855	
12	49	855	7	17	None	855	
13	20	306	8	17	128	319	Disctron 526, MMI M125
14	42	733	7	17	None	733	
15				(Reserved)			
16	20	612	4	17	0	663	Microscience HH725, Syquest 3250, 3425
17	40	977	5	17	300	977	
18	56	977	7	17	None	977	
19	59	1024	7	17	512	1023	
20	30	733	5	17	300	732	
21	42	733	7	17	300	732	
22	30	306	5	17	300	733	Seagate ST4038
23	10	977	4	17	0	336	
24	40	1024	5	17	None	976	Seagate ST4051
25	76	1224	9	17	None	1023	Seagate ST4096
26	71	1224	7	17	None	1223	Maxtor 2085
27	111	1224	11	17	None	1223	Maxtor 2140, Priam S14
28	152	1024	15	17	None	1223	Maxtor 2190, Priam S19



G5860PC

Type	Size (MB)	Cylinders	Heads	Sectors	Write Precomp	Land Zone	Example Model
29	68	1024	8	17	None	1023	Maxtor 1085, Micropolis 1325
30	93	918	11	17	None	1023	Maxtor 1105 1120, 4780
31	88	925	11	17	None	1023	Maxtor 1170
32	69	1024	9	17	None	926	CDC 9415
33	85	1024	10	17	None	1023	
34	102	1024	12	17	None	1023	
35	110	1024	13	17	None	1023	
36	119	1024	14	17	None	1023	
37	17	1024	2	17	None	1023	
38	136	1024	16	17	None	1023	
39	114	918	15	17	None	1023	Maxtor 1140, 4380
40	40	820	6	17	None	820	Seagate ST251
41	42	1024	5	17	None	1023	Seagate 4053
42	65	1024	5	26	None	1023	Miniscribe 3053/6053 RLL
43	40	809	6	17	None	852	Miniscribe 3650
44	61	809	6	26	None	852	Miniscribe 3675 RLL
45	100	776	8	33	None	775	Conner CP3104
46	203	684	16	38	None	685	Conner CP3204
User Defined							